



Dealing with Heritage

Assessment and Conservation

**Barbara Lubelli
Uta Potgiesser
Wido Quist
Susanne Rexroth**

Dealing with Heritage

This publication was made possible thanks to the support of
the Rondeltappe Bernoster Kemmers Foundation.

Cover image: Building, Curacao / Photo: B. Lubelli

ISBN 978-94-6366-476-9

© 2021 TU Delft - Heritage & Architecture

No part of these pages, either text or image, may be used for any purpose other
than research, academic or non-commercial use.

The publisher has done its utmost to trace those who hold the rights to the
graphic material used.

Dealing with Heritage

Assessment and Conservation

Barbara Lubelli

Uta Pottgiesser

Wido Quist

Susanne Rexroth



City hall Middelburg / Photo: W.J. Quist

Preface

*ir. Ramon Pater, Restoration advisor and director archivolt architecten bv,
Chairman of the 'Vereniging van Architecten Werkzaam in de Restauratie'*

It is an honor to introduce this book, which brings together a number of very important aspects of the restoration architect's profession, with this short statement.

Dealing with heritage requires that the restoration architect makes well-considered and definable choices. It should not only be about conservation, but attention must and may also be paid to making heritage future-proof. When it comes to making heritage future-proof, we still stand at the start of a major (sustainability) transition, in which making interventions will be indispensable. Such interventions are made possible by recognizing and utilizing the opportunities that heritage offers, but they should always be made from a view that places the preservation of the core values of the heritage centrally.

The core values of heritage take many forms and can range from physical architectural manifestations to social, cultural and historical significance. In all cases, they involve dealing with the materials that the heritage is composed of. Having knowledge of these materials plays a crucial role in the choices to be made, both in the area of conservation to preserve what already exists, as well as in choices for restoration, improvement or renewal. That this knowledge goes beyond the physical outward appearance, as perceived by the admirers of heritage, is also emphasized by the examples in this book. Knowledge of the substance, forms of decay, methods of conservation and application of new techniques requires

research, and without this research we as restoration architects would never be able to make well-considered choices.

Research into especially the 'invisible' damage phenomena in materials, as described in this book, still requires more attention. As certified restoration architects it is our task to recognize this, to call in specialists at an early stage of a project, and to consider options with as broad a team as possible. The methods with which to determine the degree of damage and decay as objectively as possible, as are being developed continuously by among others 'Heritage & Architecture' at Delft University of Technology, offer good tools.

I am a restoration advisor and currently chairman of the 'Vereniging van Architecten Werkzaam in de Restauratie' (Association of Architects Working in Restoration, VAWR), an association whose members are specialists who have all chosen to be tested and recognized in the field of dealing with monuments. On behalf of our members I would like to draw attention to the specific mastery of our profession based on Knowledge, Ethics, Vision and Management. Much attention is drawn to precisely these four pillars in this book as well. I hope that the readers of this book, regardless of their background, will gain a great deal of knowledge and appreciation for the need for research, but above all that they will also become more interested in our beautiful and multifaceted profession.



Former beer brewery 'Drie Hoefijzers' / Photo: W.J. Quist

Table of Contents

- 1 – Introduction: the conservation process 9
Wido Quist
- 2 – Conservation of natural stone 17
Wido Quist
- 3 – Decision-making in the intervention on
buildings affected by rising damp 37
Barbara Lubelli
- 4 – Treatment of historic surfaces with water repellent and
consolidation products: choices for intervention 51
Barbara Lubelli
- 5 – Conservation of windows and glazing 73
Uta Pottgiesser & Susanne Rexroth
- 6 – Conclusions 111
- References 113
- Colophon 120



Hunting lodge Mookerheide / Photo: W.J. Quist

1 – Introduction: the conservation process

Wido Quist

The heritage field in general and heritage conservation in particular present a distinct discipline: the past, present and future are constantly at odds with each other. There is a need to find a balance between preservation and renewal and there is a constant discussion about what to preserve and how to preserve it. The discussion on what to preserve takes place in the field of valuation: the statement of significance. Decisions in the field of conservation have a high degree of complexity, as they involve many dimensions and multiple actors with possibly different and conflicting objectives (e.g. conservators, local authorities, owners).

Most interventions may have irreversible effects on architectural heritage in terms of material decay and/or loss of heritage value. Therefore, decisions in this field should consider aspects inherent to both technology (related to material and construction) and values (related to intangible aspects including aesthetic, artistic and social values) and be based on knowledge of the effects of past interventions. The financial framework is also essential.

This is not always the case in the present conservation practice. In general, decision-making processes in the field of conservation lack a transdisciplinary approach necessary when dealing with the multifaceted problems involved in the conservation of cultural heritage (Avrami et al., 2000).

1.1 – Material value

There are many ways to value heritage and to determine which aspects - tangible or intangible - are of essential importance. This book does not examine these valuation methods or make a statement about a possible classification and ranking of the various indicators in relation to each other (see two previous volumes in this series: Meurs, 2016 and Kuipers & De Jonge, 2017). This book starts with the premise that the material authenticity of built cultural heritage is considered so important that all necessary effort will be made to preserve it and pass it on to the next generation(s).

In keeping with this point of departure, the obvious thing to do is to choose restoration materials carefully and in the service of the authentic material.

Decisions on what to conserve – based on the heritage significance - are frequently taken independently from those on how to conserve. This is partially due to the isolation of the research and professional fields (architectural history, building archaeology, conservation sciences and design). Even when a multidisciplinary approach is attempted, experts in the different fields are often only consulted during distinct phases of the decision process, with little interaction between them as a result. Because of the great attention paid to what to preserve in the preparatory phase of a restoration, it sometimes seems that the discussion about preserving heritage stops there. The discussion about how to preserve often takes place in a much smaller group and with far fewer accompanying discussions or are just left to the contractor (see also Quist, 2011).

Dutch context

This book especially refers to the Dutch context when it comes to materials, the legal framework and the organisation of building and restoration processes. This does not mean that the book is not applicable to other countries; it only requires a reinterpretation with regard to other materials, damage processes and legal contexts.

The relevance of the original building material and, by extension, its preservation, has always been one of the most important pillars of monument protection in many (Western) countries and certainly in the Netherlands. This is evident, for example, from formulations in the 1917 Dutch Grondbeginselen, published by the Royal Netherlands Antiquities Association (KNOB) and the Monumentenwet (1961, 1988; Monuments Act), the conservation policy of the Cultural Heritage Agency (RCE, and its legal predecessors) and the importance that the Netherlands has always attached to the 1964 Venice Charter. The principles behind the Uitvoeringsrichtlijnen (URLs; Implementation Guidelines) issued in recent years by the Stichting Erkende Restauratiekwaliteit Monumentenzorg (Foundation ERM for Accredited Restoration Quality, cf. Naldini et al. 2020) are also based on maximum conservation of the original material. There are various reasons why maximum conservation is not the same as conservation of all original material. We need only to refer to Tillema (1975) in which he illustrates, with many before and after photos of restored buildings, how much some heritage buildings have changed during restoration and how much historic building material has therefore disappeared. His analysis of restoration projects completed and of national policy, as well as the examples cited by Denstagen (1987), show that restoration principles are not always consistent with each other, and the interpretation of those principles often differs between theoretical art historians and pragmatic architects. It is also not always possible to reconcile them. This consequently regularly leads to the removal of historic building material from monuments without there being an immediate demonstrable technical need to do so.

1.2 – Transdisciplinary approach

A new, transdisciplinary approach, that enables a balanced consideration of technical-, value- and design-related aspects through the full process of heritage conservation, renovation and re-use of buildings and building parts, is needed. In this approach different disciplines are integrated in the full decision process instead of assembled in a disjointed sequence. The present organization of the Heritage & Architecture (HA) section of the Faculty of Architecture and the Built Environment of Delft University of Technology (TU Delft) concretizes this much-needed transdisciplinary approach in its educational structure: students are encouraged to integrate value and technical aspects in their design intervention on heritage buildings [FIG. 1.1].

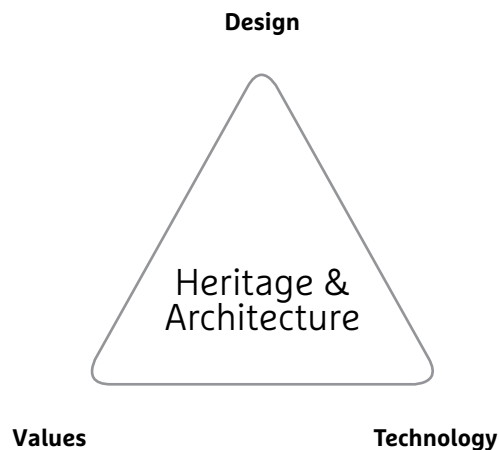

FIG. 1.1 HA-triangle reflecting the mission of the three chairs

(Digital) tools or guidelines to support the choice of interventions in built heritage through the assessment of the possible consequences of different scenarios could be a great help in conservation practice.

1.3 – Methodological context of the conservation process

The International Charter for the Conservation and Restoration of Monuments and Sites (The Venice Charter), one of the results of the Second International Congress of Architects and Specialists of Historic Buildings held in Venice in 1964, is still one of the most referred to documents with respect to the preservation of historic buildings (Venice Charter 1964). It is centred around the notion of authenticity. The concepts of reversibility and minimal intervention are related to the reasoning of the Venice Charter, but unlike what is often assumed, are not a textual part of the Charter (Quist 2011). The interpretation of 'authenticity' has caused and still causes a lot of debate also in relation to previous interventions. Authenticity is also of importance in World Heritage listing and management. The Operational Guidelines for the Implementation of the World Heritage Convention (2019), mention that nominations need to meet the criteria of authenticity, referring to the Nara Document on Authenticity (Nara 1994). Many policy documents refer to authenticity in a comparable way, leaving much space for interpretation. In the NEN-EN 15989:2019 - Conservation of cultural heritage - Main general terms and definitions, authenticity is defined as the: 'extent of alignment between an object and the identity attributed to it' where object is defined as 'single manifestation of tangible cultural heritage'.

Reversibility was actually defined a few years before the Venice Charter, in the 1961 American Institute for Conservation (AIC) Code of Ethics: 'The conservator is guided by and endeavours to apply the 'principle of reversibility' in his treatments. He should avoid the use of materials which may become so intractable that their future removal could endanger the physical safety of the object. He also should avoid the use of techniques the results of which cannot be undone if that should become desirable' (AIC 1964). This was clearly defined from a restorer's point of view and doesn't

completely match the context of the Venice Charter. The main author of the Venice Charter, R.M. Lemaire (1921-1997), had a more architectural interpretation of the term, as he used reversibility in the context of being able to distinguish and eventually remove architectural additions to historic buildings (Anonymous, 1983).

Reversibility is often not achievable and, in some instances, not applicable. It is a difficult to apply the term as a guideline in conservation practice. That's why during the nineteen nineties, the concepts of compatibility and retreatability were introduced. (Teutonico et al., 1997, p. 294) defined compatibility as: 'a treated material should have mechanical, physical and chemical compatibility with the untreated historic materials under consideration. Simply stated, compatibility means that introduced treatment materials will not have negative consequences', together with retreatability, defined as 'the possibility of applying a new treatment without negative results. Simply stated, a retreatable material (or its aging) would not preclude further treatment'. As both concepts ask for the definition of tolerance for change (Kuipers & Quist, 2013), they can be very useful terms with which to discuss possible interventions and to come to a choice for a material or technology suitable for a specific situation.

Process of intervention

By critically examining restorations that have been completed, methods and techniques used, and available restoration technology, the basic conservation process can be fleshed out as consisting of the following steps [FIG. 1.2]:

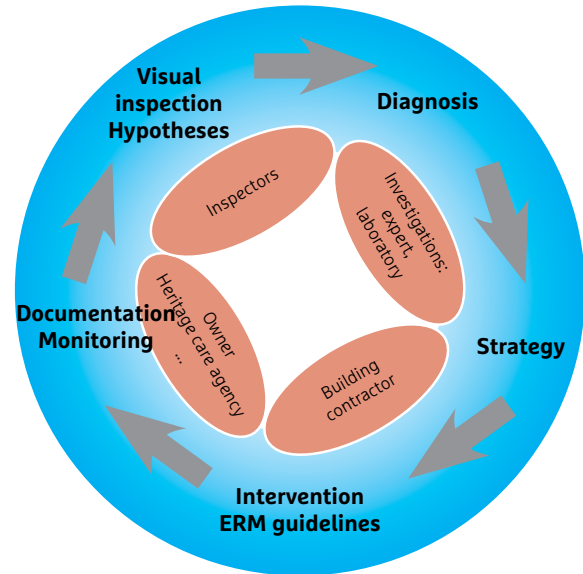

FIG. 1.2 From visual inspection to intervention and monitoring (Cf. also Naldini & Hunen 2019, p. 90)

- 1 Determining the state of conservation
- 2 Making hypotheses on possible cause(s)
- 3 Undertaking research aimed at proving or disproving hypotheses
- 4 Reaching a diagnosis of damage process(es)
- 5 Deciding on intervention strategies
- 6 Planning and carrying out interventions (maintenance, conservation...)
- 7 Documenting the whole process and monitoring the state of conservation

1.4 – Determining the state of conservation

Every intervention in a monument should start with a thorough investigation and documentation of the existing: which materials are involved and what is the technical condition? It is important that this assessment goes a step further than ‘... the natural stone is in poor condition’ and is more precise than ‘... the masonry shows frost damage’: the damage needs to be visually identified (e.g. layering) and hypotheses on its causes made (e.g. frost damaging process). It is also important that all those involved in the restoration process use the same (correct) terminology. This is not always the case in practice. In the Netherlands, a uniform approach is being developed, based on the methodology and damage definitions in MDCS (Monument Diagnosis and Conservation System, available through <https://mdcs.monumentenkenis.nl/>) and implemented in the various guidelines of the ERM and the inspection manuals of Monumentenwacht (see for example Naldini & Hunen, 2019; Naldini et al., 2019; Naldini et al., 2020; Hees & Naldini, 2020).

When describing the state of conservation, it is important to identify the material as precisely as possible. In the case of natural stone, for example, the distinction between sandstone and limestone and, where possible, the distinction between types such as Bentheim sandstone or Udelfangen sandstone can be of critical importance. Where this is not possible, a specific description can be of use. The same applies to the type of damage (e.g. sanding or flaking), the location of the damage (e.g., flat wall or cover), the amount of damage (all blocks or just a single block) and the severity of the damage (slight, moderate, severe).

Diagnosis of damage process(es) and possible causes

Before developing a proposal for intervention, it is necessary to ensure that a correct diagnosis of the damage process is made and to determine any underlying causes. Such a diagnosis can only be made if the damage found is fully documented. Often, a visual inspection will not lead to a complete diagnosis. Therefore, it will be necessary to carry out specific (material-technical) investigations in order to identify the damage process or the cause of the damage. Identification of the process and cause of damage are necessary to determine its severity and estimate its possible future development.

Determining intervention strategies

Once the damage types, processes and their causes have been identified, intervention strategies can be determined to remedy the problem and achieve the intended goal. Possible variants can be outlined, each with their specific characteristics depending on various non-material factors such as availability of materials, availability of techniques, accessibility of the site to be restored, vulnerability, historical value, level of ambition, available budget, etc..

The ERM has developed the ‘conservation ladder’ for Dutch restoration practice [FIG. 1.3]. This instrument is helpful in formulating variants for a certain intervention and in determining the most important characteristics on the basis of which a choice can be made (www.stichtingerm.nl). The ladder consists of three steps with a preferred sequence of (1) preservation/maintenance, (2) repair and (3) reconstruction, each taken while keeping the following considerations in mind:

- *Minimal intervention*
(as much as needed, as little as possible)
- *Solidity / durability*
(determining the service life of the intervention)
- *Compatibility*
– In principle the materials used for an intervention should be weaker than the original material
- Replace as much as possible with similar materials or with alike materials and/or alike techniques

Selection and implementation

A substantiated choice for an intervention strategy can only be made when the characteristics of the strategy are well defined and when the right expert opinions have been heard. Implementation can then proceed. If unforeseen situations arise during the implementation - for example, an unexpected poor technical condition - the steps described above must be followed in order to make an appropriate choice. In many instances, the process is therefore cyclical rather than linear and is influenced by the timeframe and the financial constraints of the intervention.

Documentation and monitoring

In order to close the circle of maintenance, it is important that all decisions in the process and the reasons for these decisions, including the intervention, the materials and techniques used and why they were chosen, are properly recorded so that they can be referred to at a later stage. Periodic monitoring entrusted to independent inspectors is important to properly identify the effects of the intervention. If the monitoring is well documented, this automatically lays the foundation for a new step 1 when the next intervention cycle occurs.

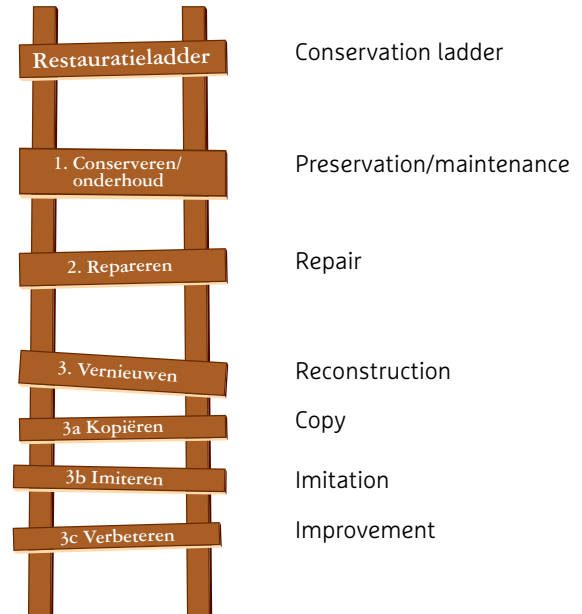

FIG. 1.3 ERM Restauratieladder (with English translation)

1.5 – Structure of the book

The complexity of making choices is addressed in this book using a number of different materials and techniques. A brief methodological context is followed by examples of approaches, developed tools and thinking models. The book thus provides examples of approaches that can be used in the integrated assessment process for the conservation and restoration of historic building materials:

- The many aspects of the conservation of historic stone is the topic of chapter 2;
- Chapter 3 focusses on the elaboration of an integrated approach to the decision process regarding the diagnosis and treatment of rising damp;
- The dilemmas and criteria for choice regarding water repellent and consolidation products will be dealt with in chapter 4;
- The challenge presented when dealing with historic window frames and glass is explored in chapter 5;

The tools, guidelines and procedures presented are not meant to dictate decisions; they rather outline the considerations that should be taken into account for sound decision-making, thereby facilitating the achievement of a well-informed agreement among the involved responsible parties. Those approaches not only will help to take the economic and technical consequences of an intervention into consideration on the short term, but will also allow to assess possible effects on for instance the monumental and social value of the building and its context and on the durability and sustainability of the intervention.



Nieuwstadkerk Zutphen/Photo: W.J. Quist

2 – Conservation of natural stone

Wido Quist

2.1 – Introduction

Natural stone has been used in many historical structures all over the world. Pieces of stone taken directly from nature - whether or not worked - were used for a wide range of objects many centuries ago already. Old stone constructions such as Stonehenge near Salisbury in England, the Parthenon on the Acropolis in Athens, the Borobodur on Java, but also the many medieval cathedrals in France appeal to everyone's imagination. It was mostly such traditional monuments that brought John Ruskin and Eugène Viollet-le-Duc to their opposing views on conservation and restoration. The principle of minimum intervention, described in the Burra Charter (1999) as doing as much as necessary and as little as possible echoes through many national and international charters and other policy documents. It is widely supported, but in the case of natural stone conservation, this principle does not provide an unambiguous direction.

The conservation of natural stone is in a specialist discipline where execution technique, art history, (building) technical and geological research need each other. Bringing these different disciplines together years ago was one of the reasons for initiating the Flemish-Dutch Natural Stone Days. In the seven editions that have already been organised, knowledge was brought together, which remained mainly in the various domains, each with its own channels for knowledge development.

Determining the type of stone, together with the determination of the damage and the cause of the damage, is important in the first instance in the conservation of natural stone. Then comes the dilemma of whether or not

to intervene, possibly followed by the choice of a particular conservation technique. In this chapter these aspects will be dealt with successively using the diagram in [FIG. 2.1].

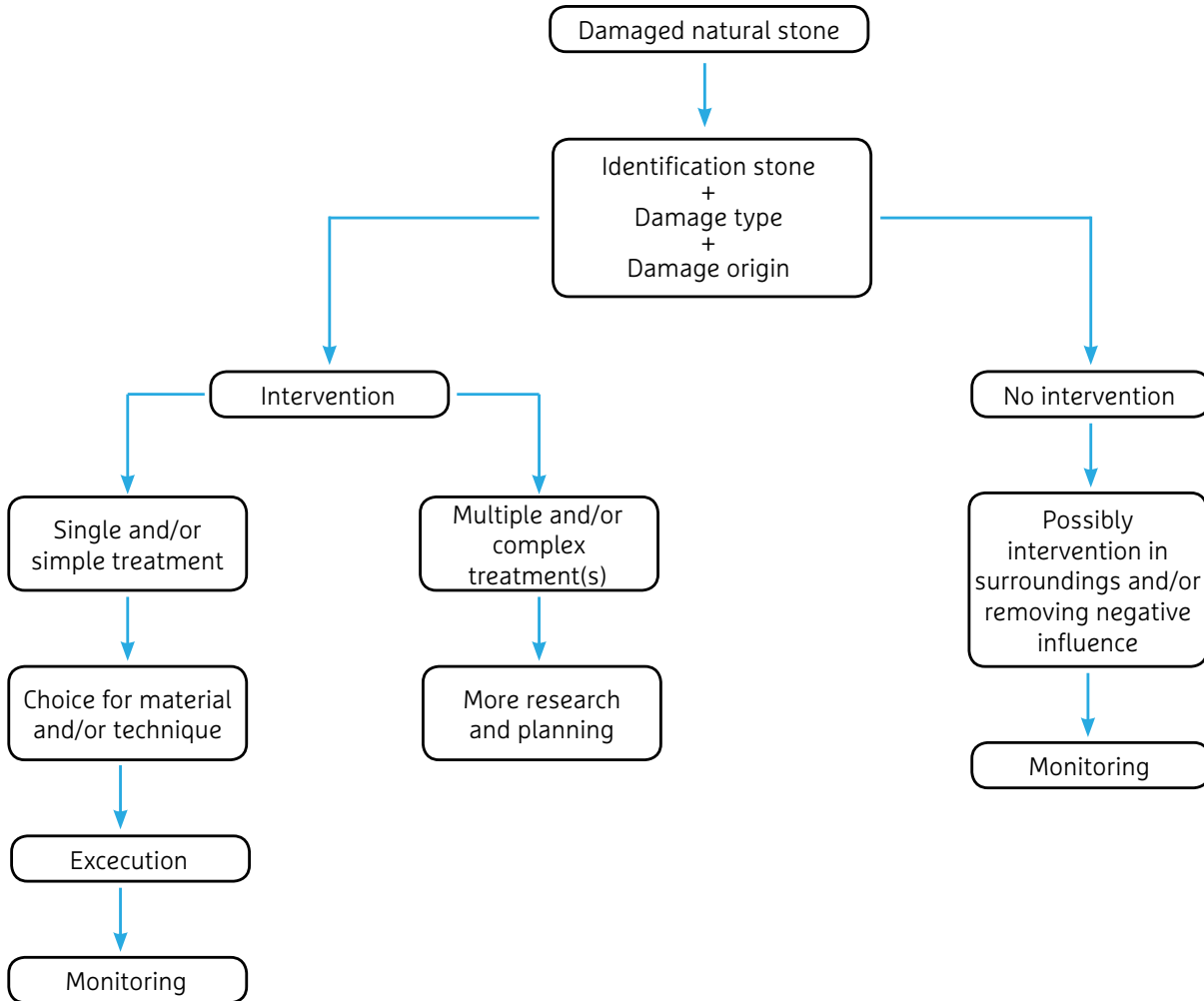

FIG. 2.1 Schematic representation of the maintenance of natural stone

2.2 – Identification of natural stone

Based on its properties the geological context of stone can be determined. And with this context as a basis, stone types and even varieties can be distinguished and identified. Determination has a threefold relevance:

- a historical relevance (where did the stone come from);
- a technical relevance (can the observed signs of ageing be explained by the type, type and origin of the stone);
- relevance to the selection of conservation techniques and materials.

In general, there are two ways to identify stone types: through historical research or through petrographic investigation. Most often a combination is used, depending on the available sources, the complexity and the importance of identifying the stone type. Studying the mineralogical composition, any fossils or inclusions present and structure and texture of a stone in order to identify stone (rocks) is called petrography. This can be done macroscopically or microscopically. Petrographic identification of stone types always starts from references: to what extent does the investigated stone correspond to another, already identified stone. Based on similar characteristics, the type of the unknown stone can then also be determined.

To determine stone types, a (often regional) frame of reference is needed. For areas rich in natural stone without many historical trade connections this will be a relatively simple and unambiguous frame of reference. But, for countries or regions without their own natural stone deposits and with many trade connections, this is a complex matter because of the great variety of natural stone types that may be found there. The Netherlands has always been dependent on supplies of natural stone from abroad (with the exception of the south of the Province of Limburg). Much of the natural stone used in Dutch monuments comes from present-day Belgium, France or Germany.

Therefore, there is no local geological reference possible. However, in many cases a first estimation can be made of the expected types of stone used in older buildings in a certain region because the transport of natural stone took place over natural waterways until the mid-nineteenth century. The choice for a material was in the past mainly related to transport opportunities and geopolitical relations with the surrounding areas [FIG. 2.2]. From the second half of the nineteenth century, stone was increasingly transported by train and a large number of new quarries were opened, so there was hardly any connectedness between the location of application and the origin of stone types (Dusar & Nijland, 2012).



FIG. 2.2 Areas of origin of natural stone types used in historic buildings in the Netherlands with their direction of distribution (base map: openstreetmap)

Identification on the basis of historic research

Building archaeological research attempts to determine the construction history of a monument on the basis of its current condition in combination with archival sources. Construction phases, materials used and techniques applied are studied prior to many restorations to create a historical picture as a basis for conservation. The interest in historic buildings, research into them and their preservation started to spread in Europe during the nineteenth century (see Jokilehto, 1986; Jokilehto, 2002; & Denstagen, 1987). The development of knowledge about historic building materials runs parallel to this.

The question of the identification of natural stone, especially with a view to choosing a substitute type of stone, already arose at the beginning of the organized preservation of built heritage in the Netherlands (Quist, 2011), when a start was made in 1903 on describing the *Nederlandsche Monumenten van Geschiedenis en Kunst* (Dutch historical and artistic monuments). The knowledge about the origin of natural stone developed rapidly and the *Rijkscommissie voor de Monumentenzorg* (National Commission for the Preservation of Historic Monuments) and the associated *Rijksbureau* (National Office for the Preservation of Historic Monuments) were established in 1918. A major contribution to this knowledge production was made by mining engineer A.L.W.E. van der Veen, construction supervisor J.A.L. Bom and the State Sculptors N. van der Schaft and A. Slinger (Quist, 2011; Quist & Nijland, 2013). Overviews of the historical context of natural stone used in the construction of historic buildings are described for the Dutch situation in Slinger (1980/1982), Janse & De Vries (1991), Dubelaar, Nijland & Tolboom (ed. 2007/2012) and Quist & Tolboom (ed. 2017). Many stone elements used in Dutch historic buildings can be identified with the help of these sources. In addition to these general informants, archival sources can provide specific information about the origin of natural stone at an object. Accounts, travel reports and supervisor's reports sometimes provide concrete information

about the purchase and processing of natural stone, for example. In addition, from the research into the persons involved in the building or restoration processes can also be deduced which types of stone may have been used.

Petrographic identification

Identification of stone with the naked eye, possibly assisted by a handheld magnifying glass, is often implicitly based on the historical context. In the Netherlands, it is unlikely that a piece of Lede stone will be used in Groningen in the sixteenth-century or a piece of Bentheim sandstone in the fourteenth-century in Maastricht, for example. Visual observation mainly focuses on block size, part, location, colour and texture, finish and weathering. All of this is related to the researcher's frame of reference. Databases with photographs of stone surfaces or collections with samples can be very helpful in this form of identification (see, for example, <https://lithotheek.monumentenkenis.nl>). In the case of microscopic identification, a thin-section is made which then is studied using an optical microscope under polarized light [FIG. 2.3]. For this purpose, a piece of stone (typically 2 x 3 or 3 x 5 cm) is cut and dried, polished and glued on a glass plate. Subsequently, the specimen is ground and polished again down to a thickness of 30 µm. Finally, it is covered by a thin glass plate. Prior to grinding and polishing, the sample may be vacuum impregnated by a coloured resin to make it easier to detect voids, pores, cracks, etc., though this is not necessary. Petrographic analysis of thin-sections is most known from geology, but has since its invention in the 19th century been applied to all kinds of (stone-like materials) including cements, ceramics, etc.. In addition to identifying the stone, petrographic analysis can also assist in identifying damage mechanisms, e.g. the influence of air pollution on calcareous materials (see e.g. Nijland & Larbi, 2010).

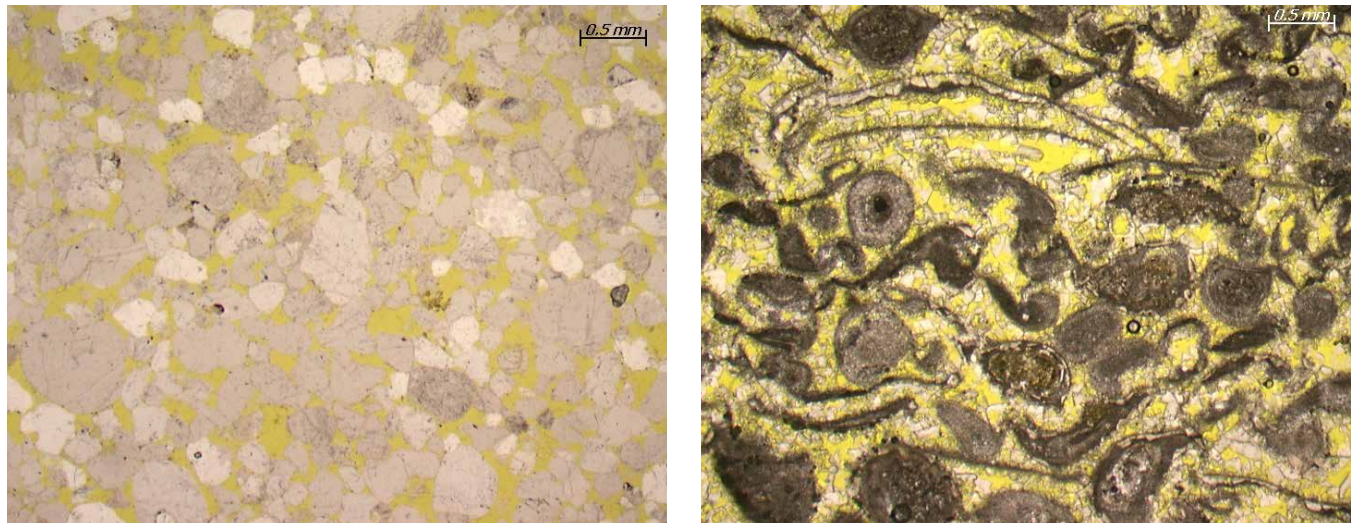

FIG. 2.3 Thin-section of Bentheim sandstone (left, TNO-00445) and Morley limestone (right, TNO-0364). The yellow in both grinding plates is the synthetic resin that has run into the (open) pores during impregnation. In the image of Bentheimer sandstone, the grey/white quartz grains are clearly visible, whereas in the image of Morley limestone various fossil and oolites remains are visible / Photos: T. G. Nijland, TNO

2.3 – Most important stone types in Dutch monumental buildings

The number of stone types (rocks) is almost infinite. Overviews can be made with the most important types that were used during a certain period for each region or country. [TABLE 2.1] lists the important species which appear as building or sculpture stones on the exterior of historic buildings in the Netherlands in 2020. Most are sedimentary rocks: sandstones and limestones. In addition, there are a number of stone types of volcanic origin on our monuments. To provide an overview, some other types of stone have also been added to the table, such as the metamorphic slate found on many historic roofs and quartzite - known for example from floors from the Reconstruction era - and the Carrara marble used on various statues, memorials and in interiors.

From the almost inexhaustible list of polished decorative limestones, only two examples are put in the table as an illustration (see for instance Quist 2020 for the great diversity of polished limestone in various natural stone collections). In the table, a distinction is made between the stones that were traditionally used before 1850 (but also still after that) and the stones that were mainly used after that time for new buildings and as replacement stones in restorations.

TABLE 2.1 Important construction and sculpting stone types in Dutch monuments

		IN COMMON USAGE BEFORE 1850	APPLIED AFTER 1850 AND AS RESTORATION MATERIAL
Sedimentary rock	<i>Sandstone</i>	Bentheim Sandstone (D) Obernkirchen Sandstone (D) Baumbergen Sandstone (D)	Udelfangen Sandstone (D/L) Rackowicze Sandstone (PL)
	<i>Limestone</i>	Lede or Balegem Stone (B) Gobertange (B) Blue Belgian Limestone (B) Maastricht limestone (NL) Kunrade limestone (NL)	Euville limestone (FR) Savonnières limestone (FR) Vaurion / Massangis limestone (FR) Muschelkalk limestone (D) Portland limestone (GB)
Igneous rock	<i>Plutonic rock</i>	Drachenfels Trachyte (D)	Weidenhahn Trachyte (D) Tepla Trachyte (CZ)
	<i>Eruptive rock</i>	Eifel Tuffstone (D)	Mayen Basalt (D) Peperino Duro (I) Volvic (F)
Metamorphic rock		Slate (diverse) Carrara marble (I)	Quartzite (diverse)

2.4 – Diagnosis of damage

In order to determine whether intervention is required and, if so, what kind, it is very important that the preliminary investigation does not stop with the identification of the stone types and the documentation of the damage (and its severity). It should also identify the underlying damage mechanism. It is only possible to determine which intervention is desirable when the damage mechanism is known. To this aid, a damage atlas has been compiled through various European projects and, with a final adaptation within the MonumentenKennis-project (<https://mdcs.monumentenkenis.nl>), and included as part of the Monument Diagnoses and Conservation System (MDCS).

MDCS is an interactive support tool for the inventory and evaluation of damage to historic buildings. MDCS helps to identify the types of materials and the types of damage during visual inspections. MDCS focuses on various materials - including natural stone. Other sources for damage diagnosis, such as the Illustrated Glossary on Stone Deterioration Patterns published by the ICOMOS International Specialist Committee for Stone in 2008, which is partly based on MDCS, focus specifically on natural stone (ICOMOS-ISCS, 2008). Damage to (natural) stone can be identified and defined relatively easily with the help of the description of the damage and the accompanying photographs of examples [TABLE 2.2].

TABLE 2.2 The structure of the damage atlas in MDCS

Surface change	Disintegration	Cracking	Deformation	Mechanical damage	Biological growth	Missing part
Chromatic alteration	Layering	Crack	Bending	Scratch	Higher plants	Lacuna
Deposit	Detachment	Hair Crack		Cut / incision	Lichens	
Transformation	Loss of Cohesion	Crazing / Craquelé		Perforation	Liverworts	
		Star Crack		Splitting	Algae	
		Diaclase		Chipping	Mosses	
					Moulds	

Source: <https://mdcs.monumentenkenis.nl>

2.5 – Intervention

Principles

There is hardly any situation imaginable that prescribes only one unique intervention, no matter how well the identification, the definition of the damage and the investigation of the cause of the damage have been carried out. There is always a range of options available which, depending on the preconditions, can also be carried out in various ways. Four principles of intervention with subdivision can be distinguished [TABLE 2.3], based on Henry (2006), English Heritage (2012) and the URL 4007 – Restauratie Steenhouwwerk (2013). It should be noted that damage to natural stone sometimes involves surrounding materials and consequently the conservation of natural stone often implies the conservation of joints. Although important for the overall conservation of the construction, these types of interventions are left out in this chapter.

Based on the principle of doing ‘as much as necessary and as little as possible’ from the Burra Charter, minimum intervention prevails over consolidation, over repair and over complete replacement. An intervention principle can be chosen based on the state of conservation of the natural stone component, which can then be further elaborated on the basis of durability and compatibility requirements.

TABLE 2.3 The most important intervention types applied in the conservation of natural stone

PRINCIPLE	EXECUTION	COMMENT
1. Minimal intervention	Removing loose flakes/pieces	This falls under regular maintenance and does not necessarily need to be followed by another intervention in itself.
	Cleaning	Cleaning often takes place in preparation for another intervention. Various cleaning methods are available, depending on the type of stone, the type of soiling and the purpose of the cleaning (cf. MDCS, https://mdcs.monumentenkenis.nl/wiki/page/30/cleaning-of-facades).
2. Consolidation	Surface level stone reinforcement treatment	If, for example, the stone surface shows chipping or sanding, the stone surface can be hardened with a stone hardener in order to slow down the decay (more information: Nijland & Quist 2017).
	Complete impregnation	Single natural stone parts can be impregnated with PMMA (Polymethylmethacrylate) in a vacuum in a laboratory. This in principle makes further deterioration of the stone almost impossible.
3. Repair	Replacing damaged parts	The damaged area is cut out and the element is supplemented with a tailor-made piece of stone affixed with the help of a mortar and possibly a dowel. As a general principle, the same stone with a similar composition as the stone to be repaired is used (see ASTM C1722)
	Mortar repair	The damaged area is cut out and completed and finished with a repair mortar, affixed with small dowels and reinforcement if necessary (see ASTM C1722)
4. Complete replacement	Natural stone	The damaged stone is removed and completely replaced by a new stone. As replacement the choice can be made for the same or a different type of stone, depending on the situation.
	Mineral stone replacement mortar/artificial stone	The damaged stone is removed and completely replaced by a replica in mineral stone replacement mortar/artificial stone. This is mostly applied to repair sculptures.

Durability

In addition to compatibility, the cultural-historical value of the natural stone part or its surroundings, the desired durability and the costs of the intervention also play a role when choosing an intervention technique or material. Nowadays, large-scale complex projects often look at the restoration horizon: how long should it take before restoration – in addition to regular and service life-extending monitoring and maintenance – is needed again? Particularly in the case of large inner city churches, where the costs of site design are very high, it is unaffordable to regularly erect scaffolding for conservation purposes. Often horizons of at least 25, 30 or 50 years are used. In these cases, therefore, not only is intervention based on the state of conservation, but an expected development of the technical state is also anticipated. In addition, the restoration horizon gives direction to the desired minimum lifespan of the intervention.

Anticipating further degradation of natural stone in the future is difficult. There are no models available for this; on the basis of experience, an estimate will have to be made with the risk that, on the one hand, restoration will be required earlier (than the intended restoration horizon) or that unnecessary historical material will be removed. Extensive intervention due to the avoidance of risk then threatens the maximum preservation of historical material. In order to still intervene as little as possible, it is necessary to clearly identify the risks. [TABLE 2.4] shows a number of example situations with a higher risk in which consideration must be given to how the risk can be reduced. In some cases, this is possible by taking extra precautions, in other cases it will lead to a heavier intervention principle being chosen.

TABLE 2.4 Risk situations that may help determine the choice of intervention on natural stone (based on Lubelli et al. 2018, see also Lubelli et al, 2021)

	SITUATION	POINTS OF ATTENTION TO AVOID OR REDUCE RISK
Lifespan	Distant restoration horizon (30-50 years)	Don't use stone consolidants. Don't use repair mortars. In the case of partial replacement, and depending on the geometry, provide extra securing and ensure that new elements are not too small.
Safety	Risk of safety in the event of failure	Don't apply repair mortars, or fix the mortars extra secure to the substrate. In the case of partial replacement, and depending on the geometry, provide extra securing and give extra attention to the size of the elements. Inspect regularly.
Use	The repair must be able to bear a mechanical load (including over-hanging and cantilevering repairs)	Don't use repair mortar or provide extra fixing to secure the mortar extra to the substrate and/or use a mortar with high mechanical strength. No partial replacement or additional securing to the substrate.
Extent	Damage over 80-100% of the surface of the stone	Don't use repair mortar or pay extra attention to compatibility requirements or provide extra fixing to secure the mortar extra to the substrate.
Form	Damage with minimal thickness at the edges	Remove additional material to improve the form.
Thickness	Component to be repaired is more than 20 mm thick	Don't use repair mortar or provide extra securing and reinforcing to the repair.
Substrate	Difficult to repair stone (e.g. tuff stone)	Do not apply repair mortar or pay extra attention to compatibility requirements. Partial replacement only of large pieces.
Type of damage	Flaking, delamination or exfoliation	Carefully cut back to sound stone.
Salinity	Substrate has high saline load and/or salt damage	Do not apply repair mortar or desalinate substrate and/or pay extra attention to compatibility requirements. In case of partial replacement, desalination and/or extra attention to compatibility requirements of repair mortar and replacement stone.
Dampness/moisture load	Substrate has high moisture load	Do not apply repair mortar or address source of moisture and/or pay extra attention to compatibility requirements. In case of partial replacement, address moisture source and/or pay extra attention to compatibility requirements of fixing mortar and replacement stone.

Compatibility

When maintaining natural stone, the most basic principle should be that the intervention should be compatible with the existing and at the same time be as durable as possible. Aesthetic and technical aspects are taken into account to determine compatibility. Historical aspects can sometimes also be taken into account (Quist 2011). In principle, repair or replacement with the same stone type as the original is the most compatible option. If this is not possible (availability) or

desirable (durability), or if too much historical material is lost as a result, an alternative should be sought. The most suitable alternative can be found by formulating the compatibility requirements as clearly as possible, also in relation to earlier interventions.

TABLE 2.5 Table for formulating principles of natural stone repair or replacement based on (Quist 2011 and Lubelli et al. 2018, Lubelli et al 2021)

		PERFORMANCE REQUIREMENT
Aesthetic compatibility	Colour – new	
	Colour – after a period of time	
	Texture	
	Finishing/treatment	
	Geometry	
Technical compatibility of stone	Mineralogical composition	
	Moisture transfer	
	Environmental factors	
	Geometry	
Technical compatibility of a repair mortar	Moisture transfer	
	Adhesion	
	Elasticity module	
	Hygroscopic and thermal expansion	
	Chemical compatibility	
	Geometry	

Those aspects relating to aesthetic compatibility in the event of repair or replacement are similar. The requirements will mainly relate to the colour and texture, but the desired finish and geometry will also have to be formulated in relation to the substrate and the immediate surroundings. As far as technical compatibility is concerned, the aspects for replacement stone differ slightly from those for repair mortars [TABLE 2.5].

It can be very helpful to first draw up an abstract restoration vision in which the broad outlines of the goals are laid down, because the conservation of natural stone is rarely a stand-alone intervention in a restoration. Examples such as the Eusebius Church in Arnhem, the Cunera Church in Rhenen and the Royal Palace in Amsterdam show how a restoration vision that includes an integral vision on the conservation of natural stone, can be a good guideline for taking decisions on the conservation, repair and replacement of natural stone in stages (see also Kooten et al. 2012).

2.6 – Example: Conservation of Bentheim sandstone

Bentheim sandstone is quarried near Bad Bentheim in Germany, just across the Dutch border. Bentheim sandstone has been in use as a building stone in Germany and the Netherlands for many centuries. It has a very high quartz content and is basically a durable stone that can withstand the Northwest European climate. Over the years, the material acquires a light grey to almost black patina. Despite its high durability, monuments made of Bentheimer sandstone are subject to many interventions for a variety of reasons. Of these, replacement with other types of stone are the most visible, but mortar repairs and partial replacement are also common. The diversity of choices is illustrated and explained here.

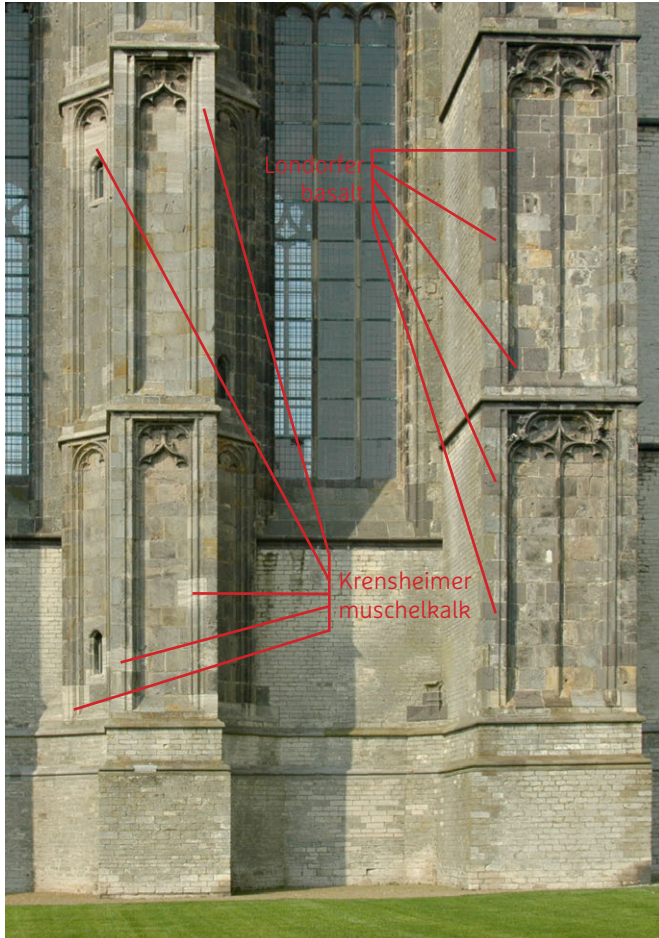

FIG. 2.4 Two adjoining buttresses on the Lievensmonster Tower in Zierikzee, with Krensheimer muschelkalk (left) and Londorfer basalt (right) as replacement stones for Bentheimer sandstone / Photo: W.J. Quist

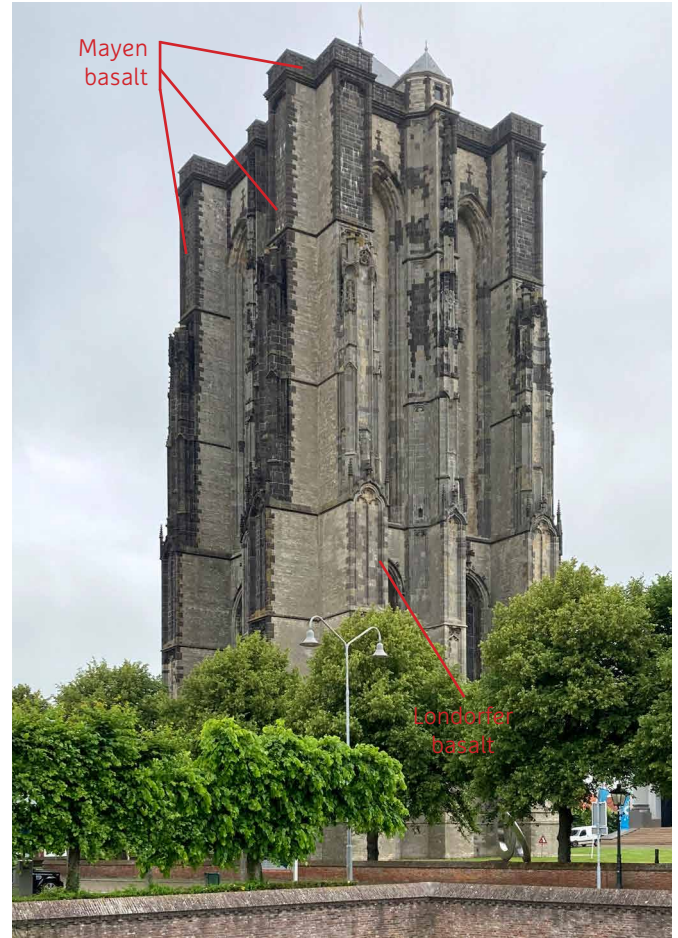

FIG. 2.5 Londorfer basalt was used as a replacement stone in the lower section of the south side of the Lievensmonster Tower in Zierikzee. At the top and on the west side, mainly Mayen basalt can be seen / Photo: W.J. Quist

Due to its high quartz content, and thus the high risk of silicosis, Bentheim sandstone acquired a bad reputation in the Netherlands at the end of the nineteenth century. Stone carvers and sculptors were no longer keen to work with this particular stone type. This was seen as much less of a problem

in Germany, as stonemasons there often worked outdoors rather than in a workshop, which meant that large clouds of quartz dust were much less common. In the Netherlands, limestone or sandstone, which contain less quartz, was chosen more often for repairs and for new work.

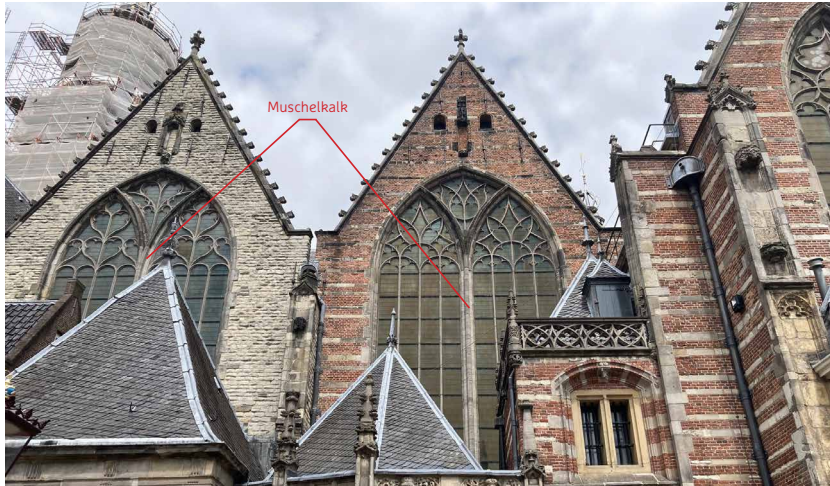

FIG. 2.6 Muschelkalk limestone as a replacement for Bentheim sandstone in the middle posts of the windows of the southern side aisle of the Oude Kerk in Amsterdam / Photo: W.J. Quist



FIG. 2.7 Peperino Duro (left) used to replace Bentheim sandstone (right) in the Nieuwe Kerk in Amsterdam / Photo: W.J. Quist

The use of Bentheim stone was first restricted in the Steenhouderswet (Stonemasons Act) and its decrees (1911/1921) and later in the Zandsteenbesluit (Sandstone Decree, 1951) (Quist 2011a, p.75-8). When the stone types used to replace Bentheimer sandstone are analysed, it appears that they were often chosen because of a colour corresponding with the grey-patinated Bentheim stone. The National Sculptor Slinger initially selected two types of stone for the restoration of the Lievensmonster Tower in Zierikzee because of the similarity in (weathering) colour and their high durability: Londerfer basalt and Krensheimer Muschelkalk. Trial applications are still a reminder of this decision making moment [FIG. 2.4]. Londerfer basalt was selected as the best choice for this restoration, but halfway through the restoration another replacement stone, Mayen basalt, was chosen because of the high cost associated with the former. Mayen basalt is a very dark basalt type and it unfortunately has little in common with the (weathered) sandstone for which it serves as a replacement [FIG. 2.5] (Quist 2012a; Quist 2012b).

The (financial) progress of the restoration was given priority over the return to the original aesthetic compatibility requirements. Other examples include the use of Krensheim Muschelkalk (limestone) as a replacement stone for Bentheim sandstone at the Oude Kerk in Amsterdam [FIG. 2.6], while Mayen basalt and Peperino Duro were used at the Nieuwe Kerk in Amsterdam [FIGS. 2.7/2.8]. Incidentally, the Bentheim Sandstone of the balustrade of the Nieuwe Kerk in Amsterdam has a much blacker patina than the Bentheimer Sandstone of the Lievensmonster Tower, so the black basalt here more closely approaches the colour of the original balustrade. Basalt from the French Volvic is frequently used as a replacement stone on the Utrecht Dom Church [FIG. 2.9]. Because of its grey colour, the Volvic basalt is, at some distance, difficult to distinguish from the weathered Bentheim sandstone that it replaces.

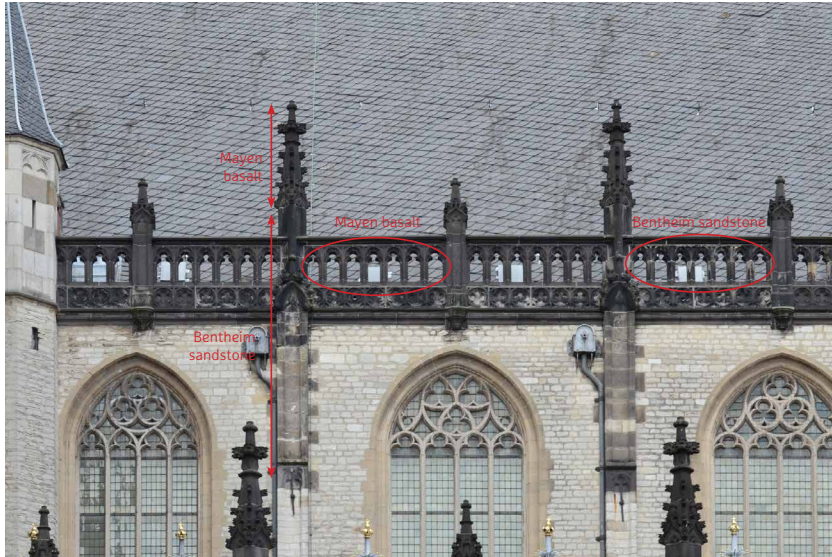

FIG. 2.8 Mayen basalt used to replace Bentheim sandstone in the Nieuwe Kerk in Amsterdam / Photo: W.J. Quist



FIG. 2.9 Volvic basalt on the stair tower of the south transept of the Dom Church in Utrecht, as a replacement for Bentheim sandstone / Photo: W.J. Quist

The ban on sandstone processing from 1951 onwards did not only led to the use of many other types of stone, as also the replacement of whole stones took preference over patch repairs affixed with dowels or using repair mortar. This is because a lot of sandstone dust is released during the preparation of the stone for affixing with dowels, as is when the stone is roughened to ensure a good adhesion surface for a mortar repair. The use of sandstone has been allowed again under health and safety legislation since the 1990s, partly in reference to the continued use of sandstone in Germany. An example of a large-scale application of sandstone was the use of Rackowicze sandstone in the restoration of the Pieterskerk in Leiden during 2000-2011 [FIG. 2.10]. Here Ettringen tuff stone, which was used in the early twentieth century as a replacement for the original Bentheim sandstone, was replaced. The use of Bentheim sandstone for the restoration

of Bentheim sandstone also returned to such a degree in this period that currently almost no other replacement stone is used [FIG. 2.11]. The (large) colour difference between the dark weathered old sandstone and the light, cream-coloured fresh stone is a factor to consider. Sometimes the choice is made to show this difference, including also the difference in surface finishing, but more often the choice is now made to 'artificially patinate' or 'undisturb' (as opposed to restore) the new stone. This involves either applying colour to the stone surface using chalk in various shades, which is then fixed with a binding agent, or by spraying several colours of silicate paint (Brans 2012; Nijland 2012).

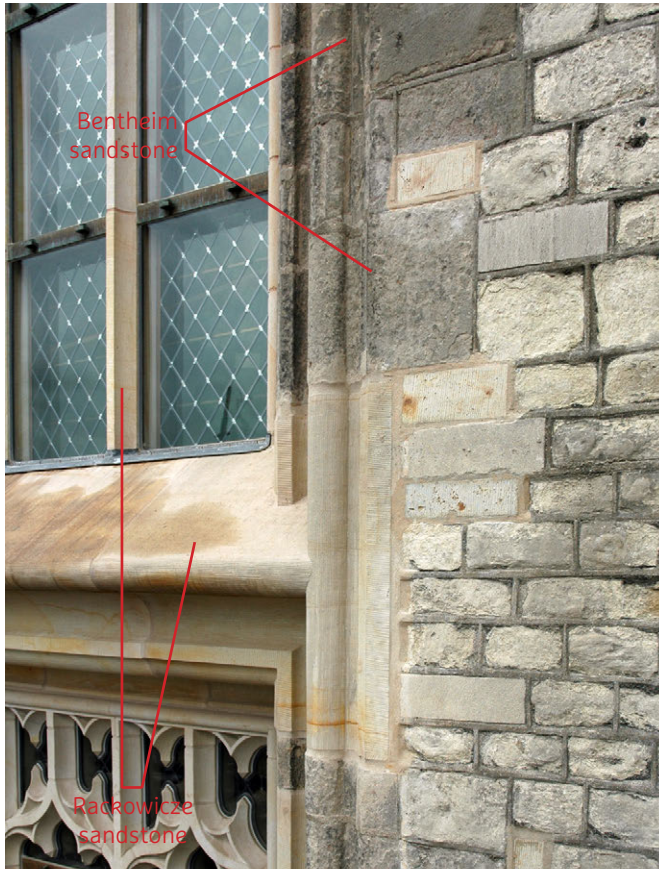

FIG. 2.10 Rackowicze sandstone at the large window in the north transept of the Pieterskerk Leiden / Photo: W.J. Quist



FIG. 2.11 Bentheim sandstone at the south portal of the Sint-Joriskerk Amersfoort / Photo: W.J. Quist



FIG. 2.12 The painted lantern of the Laurens Church tower in Rotterdam before conservation / Photo: W. Quist



FIG. 2.13 The lantern of the Laurens Church tower in Rotterdam after conservation / Photo: W. Quist



FIG. 2.14 Artificially patinated Bentheim sandstone on the lantern of the Laurens Church tower in Rotterdam / Photo: T.G. Nijland

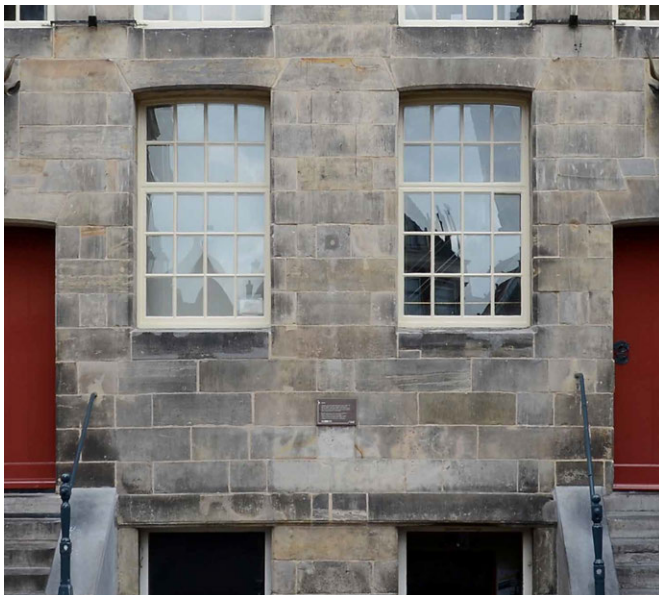
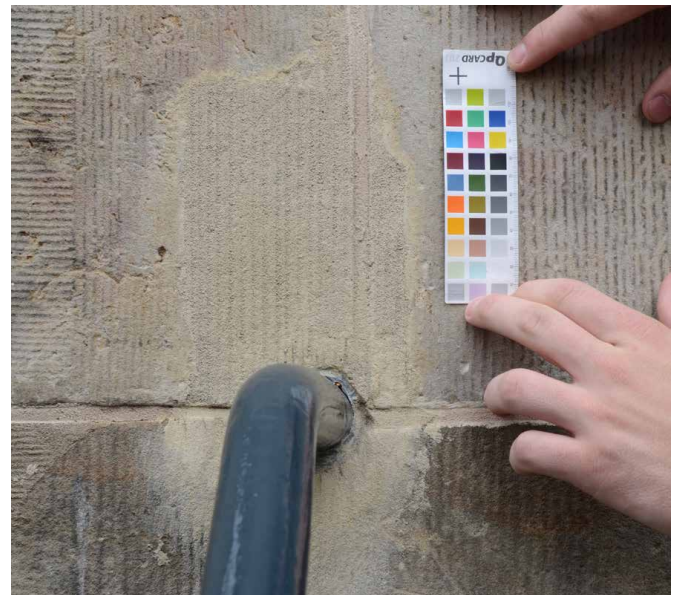

FIG. 2.15 The front façade of the Koornbeurs in Delft / Photo: W.J. Quist



During the conservation of the lantern of the tower of the Laurens Church in Rotterdam, all layers of paint were removed and the tuff stone – from an earlier restoration – was largely replaced by Bentheim sandstone, of which the lantern had once consisted entirely. In order not to let the fresh new stone stand out from the weathered old stone, an artificial patina was applied to the sandstone in the lantern. It was, however, decided not to patinate the – completely replaced – cornice pinnacles, as they together form an architectural unity [FIGS. 2.12/2.13/2.14]. Over time, the balustrade with corner pinnacles will develop a patina, depending on their orientation. The argument for architectural legibility was also used in the restoration of the facades of the Royal Palace in Amsterdam. For these façades, which consist of Bentheim sandstone and Obernkirchen sandstone, a detailed vision on the conservation was formulated at block level: it was decided to use a mix of cleaning, patch repair, replacing and artificially ageing, with the aim of bringing the façades into technical order and creating architectural unity (Bommel, 2012; Nijland 2012).

The use of repair mortar also increased simultaneously with the renewed use of Bentheimer sandstone. Jahn mineral mortars, whether or not specially made to colour, were often used to repair Bentheim sandstone (Lubelli et al., 2018; Lubelli et al., 2021). This repair mortar has proven its worth especially in facades with a large number of relatively small damages to several natural stone blocks, due to rusting iron or mechanical impact. The facade of the Koornbeurs in Delft has, for example, regained its aesthetic and technical unity through a combination of cleaning, repointing and a great deal of attention to the colour and finish of the mortar [FIG. 2.15]. There are still some traces of paint on this façade, which raises the question of what historical aesthetic unity has been reinstated. It is known that many natural stone facades were once painted. Discussion on the application of a new coloured finishing layer to natural stone during restoration has become a more and more frequent occurrence in the Netherlands over the past decade, but this is still only rarely applied (Naldini 2016, Kip 2007).

2.7 – Lessons learnt

In the Netherlands, the absence of comparable replacement stones for many years meant that the choice of a stone type had to be explicitly substantiated. Probably because of the dark patina that Bentheim sandstone develops – which in many cases is not harmful to the stone – blending with the appearance of the darkened stone was the main compatibility requirement for decades. This is in contrast to the different arguments for choosing substitutes for Lede or Balegem stone as those show a wider variety ranging from (expected) durability, via availability to the rustic looks (Quist 2013). The choice of Muschelkalk, Volvic basalt and Londerfer basalt proved to be appropriate and durable over time. The subsequent choices of Peperino Duro and Mayen basalt have worked out well as far as durability is concerned, but turn out to be too dark as far as aesthetic compatibility is concerned. To what extent ‘artificially ageing’ or cleaning can offer a solution to this challenge in the future will have to be investigated further. In such cases this will have to result in lightening rather than darkening the stone. The return to the use of Bentheimer sandstone has underlined the importance of restoring with ‘the same’ material as original. Great strides have been made in terms of compatibility and durability, especially in combination with the possibilities offered by repair mortars and artificial patinas.

2.8 – Discussion

Not a single historical building is still in exactly the same state as it was once built. All buildings are subject to ageing, and during the course of history, various interventions are made for various reasons. All these changes affect the building and determine, to a greater or lesser extent, the choices for interventions. The Venice Charter (1964) already pays attention to this in its Article 11. The use of building materials and techniques is regionally and often even locally bound. In this chapter, general attention has been paid to the conservation of natural stone in historic buildings, and the influence of national regulations on how to deal with a specific conservation problem has been discussed using an example of conservation of Bentheim sandstone in the Netherlands. An exactly similar example cannot be found anywhere else in the world; the conservation of Bentheim sandstone is even handled differently in neighboring Germany. The specific characteristics of regional situations – together with the general approach of identification, damage diagnosis and the pursuit of compatible interventions – determine the framework conditions within which interventions can be designed.

The many variables therefore also indicate that no universally applicable and unambiguous answer can be found to the issue of conservation of natural stone. Within the general requirement of compatibility [TABLE 2.5] various choices can be made, all of which can be ‘good’. Compatibility requirements arise from material-technical aspects on the one hand, and on the other hand are determined by the way in which the cultural-historical value is dealt with. The final choice for an intervention is also influenced by the intended lifetime, the technical risk [TABLE 2.4] and the cost. TABLE 2.6 presents the characteristics of various principles of intervention in general terms, giving a rough indication of the lifespan, the impact of the intervention on the historic material, the technical risk involved and the cost of the intervention.

TABLE 2.6 Classification and characteristics of various conservation techniques for natural stone

PRINCIPLE OF INTERVENTION	EXECUTION	LIFE EXPECTANCY			IMPACT ON HISTORICAL FABRIC			TECHNICAL RISK			COST		
		H	M	L	H	M	L	H	M	L	H	M	L
Minimal intervention	Removing loose flakes/pieces	•	•	•			•			•			•
	Cleaning	•	•			•	•		•	•		•	•
Consolidation	Stone consolidants on the surface			•		•	•	•	•			•	
	Complete impregnation	•			•	•		•			•		
Repair	Replacing parts (Dutchmen)	•	•				•		•	•		•	•
	Mortar repair		•	•			•		•	•			•
Complete replacement	Natural stone	•			•					•	•		
	Mineral stone replacement mortar mortar/artificial stone	•	•		•				•		•	•	

H = High, M = Medium, L = Low

2.9 – Conclusion

Systematically describing of the points of departure, the considerations and the final choice is not only valuable during the execution of a restoration, but has especially great benefit afterwards. Every restoration is unique, but by systematically following a process it becomes possible to evaluate the effects of the different starting points and choices over time. Monitoring not only concludes a phase in the conservation of a heritage building, or more specifically, of a natural stone component, but will also bring to light any new degradation, making it the first step in a new phase of the heritage building's life.



Salt efflorescences in masonry /Photo: B. Lubelli

3 – Decision-making in the intervention on buildings affected by rising damp

Barbara Lubelli

3.1 – Introduction

Rising damp, i.e. the capillary rise of water from the ground to the walls of a building, is a well-known and recurrent hazard to heritage buildings. Due to climate changes, its occurrence is expected to increase in the future. The urgency and diffusion of this problem is reflected by the large variety of solutions to tackle rising damp which are available on the market. This wide and differentiated offer, together with the scarce and fragmented scientific information on the effectiveness of these methods, make it difficult (even) for professionals working in the field to choose a suitable intervention on a sound basis. In this chapter, the different steps in the investigation process for a sound diagnosis of the presence of rising damp are discussed. Moreover, a tool is proposed which can support the choice of a suitable intervention depending on the specific situation.

3.2 – The phenomenon of rising damp

The phenomenon of rising damp is more common in old than in new constructions due to the fact that historic buildings often have masonry foundations and lack of a damp-proof course, i.e. a layer hindering the water transport from the ground to the upper part of the structure. The high moisture content deriving from the presence of rising damp does not only create an unpleasant and sometimes unhealthy climate in a building, but it also considerably enhances decay processes in the materials composing the wall, as for example the rotting of wooden beams and salt crystallization [FIG. 3.1]. and/or frost damage to brick and mortar. Unfortunately, due to climate changes (e.g. increased frequency of precipitation events with long and intense rainy periods, increased salinity of ground water), the occurrence and the relevance of rising damp will probably increase in the coming decades (Nijland et al., 2009; Brimblecombe, 2010; Sabbioni et al., 2010; Horowitz et al., 2016).



FIG. 3.1 Salt crystallization damage due to the presence of salts and rising damp, Venice, Italy / Photo: B. Lubelli

The phenomenon of rising damp is quite slow. This means that damage to the building materials and structures may become visible only several years after construction or a restoration intervention. Besides, changes in the groundwater level may also affect the height up to which the water rises in the wall. Additionally, the presence of salt in the masonry may increase the maximum height reached by the rising damp (Hees and Koek, 1996; Hall and Hoff, 2007).

Possible sources of rising damp are:

- ground(water) under the foundations (vertical transport of moisture);
- ground(water) adjacent to the wall (horizontal transport of moisture);
- surface water.

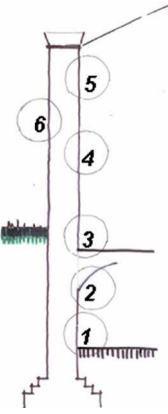

FIG. 3.2 The height of rising damp is generally limited to 1,5-2 meters, Ferrara, Italy / Photo: B. Lubelli

Contrary to what is usually assumed, rising damp from ground water may occur even when the foundations are not in direct contact with groundwater or surface water. In fact, the ground can contain a large amount of water above the groundwater level that has migrated from the groundwater zone to the upper zone by capillarity. When the foundations are in this capillary zone, rising damp may still occur in the wall.

Capillarity is the mechanism governing rising damp in a wall. Capillary forces can transport water from the ground into the wall, countering gravitational forces. Theoretically, water can rise up several metres through capillarity, depending on the pore size of the material. However, the maximum level reached by rising damp in brick and stone masonry is generally limited to 1,5-2 metres in practice, due to resistance to the flow of water, evaporation and the presence of boundaries between materials with different pore sizes (e.g. example mortar and brick) [FIG. 3.2].

TABLE 3.1 Possible moisture and salt sources

Internal face of external wall and cellar	MOISTURE SOURCES	SALT SOURCES
	5 – Rainwater penetration – Leakage of water transporting element (gutter, down pipe, ...)	– Air (aerosol) – Building materials (brick and/or mortar) – Excrements (birds)
	6 – Rain – Air humidity	– Air (aerosol) – Excrements (birds)
	4 – Rainwater penetration n.b. quality of repointing and mortar joints – Accumulation rain water due to protruding elements etc. in façade (cornice ...)	– Building materials (brick and/or mortar) – Air (aerosol) – Sea water flooding
	3 – Sideward moisture penetration from earth n.b. ground floor below level ground (earth retaining wall) – Surface condensation (thermal bridge / high air humidity)	– Groundwater – De-icing salts – Use (salt storage, stable) – Sea flooding
	2 – Groundwater / Rising damp – Sideward penetration from earth (earth retaining wall), which may be related with rainfall	– Groundwater – Fertilizers (garden) – Garden
	1 – Groundwater / Rising damp – Sideward penetration from earth	– Sea flooding – Use (salt storage, stable)

Source: MDCS <https://mdcs.monumentenkenis.nl>

There are several methods on the market claiming to solve the problem of rising damp in buildings. However, it is difficult for an owner of a building and/or for the person responsible for its conservation, to take a sound decision on how to tackle rising damp. The reason lies in the fact that, usually, no independent, scientifically-sound investigation is conducted to first assess the actual presence of rising damp and that scientifically validated information on the (long-term) effectiveness of the large variety of intervention methods is lacking. To address this lacuna, an international collaborative research project (JPICH EMERISDA) was set up a few years ago between the Netherlands (TU Delft, the Cultural Heritage Agency of the Netherlands, RCE), Belgium (Belgian Building Research Institute, BBRI) and Italy (University of Ca' Foscari, Consiglio Nazionale delle Ricerche, CNR, and a contractor). In this project a procedure for the assessment of the presence of rising damp was defined and 'standardized' as far as possible and a tool was developed to support the user in the choice of a suitable intervention method. These are described and discussed in the next paragraphs.

3.3 – Assessment of the presence of rising damp

From the research carried out in the framework of the EMERISDA project, it emerges that independent and scientifically-based investigation of the actual presence of rising damp from ground water in masonry walls is rare. Often, unreliable investigation techniques or procedures are used and/or investigations are carried out by non-independent parties such as the producer and/or merchant of products or devices against rising damp. In many cases, interventions are carried out without any investigation, but are just based on the visual observation of some symptoms such as moist spots on a wall or a humid indoor climate. However, these symptoms may also be the result of other moisture sources such as a not effective drainage of rain water or the hygroscopic behaviour of salts.

TABLE 3.1 gives an overview of possible moisture sources at the ground floor of a building.

This lack of preliminary investigation may, instead of saving money, result in higher final costs: if the moisture source is not correctly identified, the intervention will in most cases be ineffective.

Therefore, the first step in a decision-making process should be a proper investigation to come to a sound diagnosis of the moisture source. A careful visual survey of the type of damage and its distribution in the wall (e.g. by comparing lower and higher parts of the wall, external and internal walls) is the initial step in this process. It helps in developing a hypothesis on the moisture source and guiding the investigation. The presence of a drainage of rainwater, the existence of a layer of low-absorbing material in the masonry (trasraam) and the possible sideward ingress of water, e.g. in the case of retaining walls, should be checked as well. Also, the depth of the groundwater level is relevant: when the ground water is very deep, rising damp from ground water is unlikely. However, some cases may exist in which the presence of an impermeable layer in the soil, inhibiting the drainage of rain water, can lead to the formation an 'apparent' groundwater level at a higher level, possibly giving place to rising damp in the walls.

The next step in the assessment of the moisture source consists of the validation of the hypothesis, which can be done by measuring the moisture content in the wall. The gravimetric method, i.e. measuring the weight loss of (powder) samples collected from the wall after drying in an oven, is the most reliable method to assess the moisture content and distribution. Non-destructive techniques generally used by consultants in practice, such as capacitance or microwave meters, provide only qualitative results. For a correct diagnosis, the moisture distribution over the wall depth and height should be known: typically, in the case of rising damp, the moisture content in the wall decreases with height and increases with depth. Other aspects to be taken into account are (i) the contribution of hygroscopic salts to the moisture content and (ii) the porosity of the materials (some materials

may show low moisture content only because of their low porosity). The reader is referred to the paper by (Lubelli et al., 2018) for a detailed description of the suggested sampling and investigation procedure.

3.4 – Available solutions

Once the presence of rising damp has been assessed, a choice should be made on whether or not to intervene and by which method. A large range of methods and products against rising damp are available commercially; a recent and comprehensive review can be found in (Franzoni, 2018). Existing methods can be classified as follows:

- *Methods based on a reduction of water flux in ingress:* for example, creation of drains filled with coarse gravel to favour drainage of rainwater, or the application of waterproof membranes along the perimeter of the buildings;
- *Methods based on reduction of the wall sorptivity:* these methods are meant to stop the capillary rise of water above the height of the intervention in the wall. These are the most common methods and include:
 - *Mechanical interruption:* a layer of impermeable material, e.g. a lead slab, is inserted in the wall, generally after removing of a joint or of a course of masonry (see e.g. Massari and Massari, 1985) [FIGS. 3.3/3.4];
 - *Chemical interruption:* chemical products, meant to fill the pores and/or make them water repellent, are injected (under or without pressure) in a series of holes drilled at a distance of 10-15 cm from each other along a horizontal line in the wall [FIG. 3.5]. The product should spread to form a horizontal layer through the whole section of the masonry, stopping water from rising any higher up the wall [FIG. 3.6];



FIG. 3.3 Mechanical interruption of the wall by the use of plastic sheet, Venice, Italy / Photo: B. Lubelli



FIG. 3.5 Injection of a liquid product by means of pressure / Photo: B. Lubelli



FIG. 3.4 Mechanical interruption of the wall by the use undulated steel sheets, Venice, Italy / Photo: R. van Hees



FIG. 3.6 Injection of a liquid product by means impregnation with a product in the form of a cream / Photo: B. Lubelli



FIG. 3.7 Knapen syphons / Photos: B. Lubelli

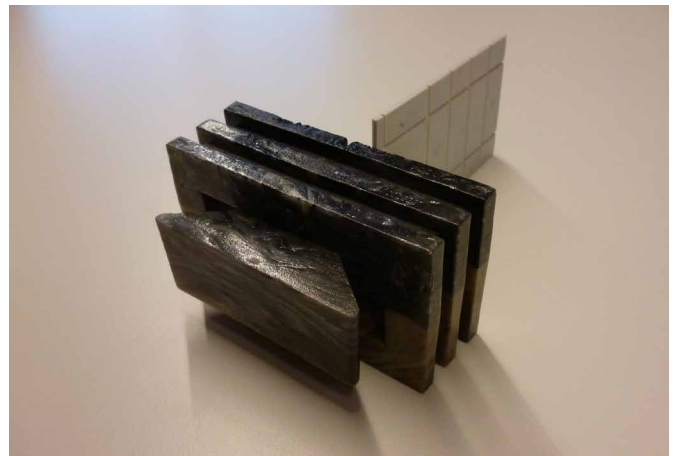

FIG. 3.8 Schrijver system / Photos: B. Lubelli

- *Methods based on evaporation increase, including:*
 - *Knapen syphons and similar devices, such as Schrijver systeem:* holes are made in the wall and the syphons are placed in them: the hole increases the evaporation surface and it might thus enhance evaporation [FIGS. 3.7/3.8]. As pointed out by Massari in (Massari and Massari, 1985), these systems may help (if not obstructed by debris) only in situations when the wall temperature is slightly lower than, or equal to that of the outside air and when the Relative Humidity (RH) of the outside air is very low. In humid regions, such as in the Netherlands, these systems are generally ineffective. Moreover, drilling a hole in the wall would work similarly (Vos, 1971) and be much cheaper;
 - *Excavation around the perimeter of the building:* the contact between the wet ground and the wall is reduced and at the same time evaporation is allowed. Additionally, mechanical ventilation can be applied, to further increase the drying at the base of the wall (Torres and Peixoto de Freitas, 2007; Guimarães, Delgado and de Freitas, 2016; Torres, 2018);
 - *Special renovation plasters:* these plasters, have generally a high and coarse porosity, which should enable a faster evaporation than traditional plasters;
- *Methods based on electro-kinetic phenomena:* next to devices based on active electro-osmosis (which are difficult to apply in practice), a large variety of devices are present on the market based often on obscure, not scientifically proven 'physical' principles (Lubelli et al., 2016; Vanhellefont et al., 2018);
- *Methods which do not tackle the rising damp, but only its symptoms:* these include veneer walls, the application of tar layers or any other materials impermeable to vapour and the use of special renovation plasters, such as salt accumulating and salt and moisture blocking plasters (Hees et al., 2008).

3.5 – Decision process

The large and varied offer of solutions available on the market, the frequent substitution of products (or just their change in name) and the scarcity of scientific and independent information on the subject, make it difficult for professionals and practitioners to choose a suitable method on a sound basis. Choices are more often based on reliance on the seller of the product, than on real knowledge on the effectiveness of the method. Sometimes, the need to respect cultural values and limit the intervention to a minimum has led to institutes for monuments' preservation giving their support to the application of methods of unproven effectiveness only because they are not invasive. The suitability of a method in a specific situation is determined not only by its technical effectiveness, but also by several other aspects, such as:

- *Owner requirements, including:*
 - *available budget:* not only the costs of the interventions in the short term, but also those of maintenance;
 - *function of the building:* e.g. a living space has different requirements in terms of comfort and indoor climate than a store; similarly, in some cases, the occurrence of damage (e.g. peeling of the paint, moist spots) can be acceptable or not, depending on the use of the space.
- *Heritage issues:* as interventions will affect the building and its materiality, issues such as compatibility, retreatability and reversibility of the intervention. Besides, in the case of protected buildings, special legislation exists and restrictions are applied

- *Characteristics of the structure to be treated, including:*
 - *state of conservation of the wall:* some methods, such as mechanical interruption, can be very risky if the structural condition of the wall is poor or the building is located in an earthquake area;
 - *properties (thickness, regularity, finishes) of the wall:* for example, injections of very thick walls can be complicated and mechanical interruption is not easily feasible in masonry with irregular courses. Injections of a masonry with many voids and/or large cracks can only occur once these have been filled, for instance with grouting.

Next to the above-mentioned factors, risks related to the intervention should be considered. For example, after a successful intervention against rising damp the wall will dry. If salts are present, salt crystallization damage will increase directly after the intervention (due to the drying of the wall and the subsequent crystallization of the salts) before stabilizing. It can therefore be wise to wait for a few months after the intervention against rising damp, before re-plastering the wall. An increase of salt damage may also occur in the case of interventions enhancing evaporation when the rising water contains soluble salts. Besides, the presence of a finish retarding or stopping evaporation in the areas where rising damp is still present, will have the risk to displace the problem, moving it higher up the wall or to the other side of the wall. In the case of shared boundary wall, it might be wise to agree on the intervention with the neighbour.

In order to support professionals in choosing a suitable intervention, a decision support tool has been developed as part the recent EMERISDA research project in which all aspects involved in the decision are considered: requirements of the owner and user of the building, technical aspects, legislative issues as well as issues related to the cultural value of the buildings [TABLE 3.2] (Lubelli et al., 2018). When using the system, the user is asked to answer questions on the different subjects and, for each possible intervention, the consequences are reported: the severity of the risks is visualized with orange and red cells; a green cell means that the method does not pose a specific risk [FIG 3.9]. The user can thus become aware of advantages, limitations and risks of each technique, compare the different intervention methods and select the most appropriate one for the specific situation. Besides, the tool helps to make clear the relevance of each aspect to all parties involved in a conservation/renovation project, supporting thereby the achievement of an agreement. The approach proposed might be considered as a kind of pilot, and it can eventually be used for other decision-making processes, also of more complex nature.

TABLE 3.2 Scheme of the structure of the prototype of a decision support tool

SITUATION	SOLUTIONS														
	Based on reduction of water flux in ingress	Based on stopping/reducing water transport higher up in the wall		Based on evaporation increase	Based on electrokinetic phenomena			Additional/alternative methods, treat symptoms							
	Sub-soil drains	Mechanical interruption	Chemical damp-proofing	Knapen Siphons & similar	Wall base ventilation	Thermal methods	Active electro-osmosis	Passive electro-osmosis	'Electro-kybernetic' and similar methods	Take no action	Veneer walls, tiles and impermeable layers	Salt blocking plasters	Salt accumulating plasters	Salt transporting plasters	Air Conditioning and/or dehumidification of air
Owner requirements															
Heritage issues															
Wall characteristics															
Moisture and salt content/damage															

	A	B	C	D	F	G	H	I	J
1				working principle >	Based on stopping/reducing water transport higher up in the wall		Based on evaporation increase		
2					These methods are supposed to reduce rising damp by making water transport through the wall more difficult or even impossible.		These methods are supposed to reduce rising damp by increasing evaporation of the water already present in the wall. The source of the moisture is not altered.		
3		situation v		solution >	Mechanical interruption	Chemical damp-proofing	Knapen Siphons & Schrijver stones	Wall base ventilation	Thermal methods
4	Owner requirements	Is it acceptable to have to do maintenance to keep the method working?	Yes	OK; no maintenance is required.	OK; no maintenance is required.	OK. Expect to have to clean the openings every so often, so the airflow is not blocked.	OK. In case of active ventilation, the devices might need maintenance.	OK; depending on heating method, device might need maintenance.	
5		Do I need to stop rising damp completely?	Yes	OK; rising damp is completely stopped above the level of the interruption.	Attention: the effectiveness of this method depends on several factors. It is advised to check the effectiveness 6-12 months after the intervention.	Risk: this method is not meant to stop rising damp completely but to reduce the MC in the wall. The effectiveness of this method is low.	Risk: this method is not meant to stop rising damp completely but to reduce the MC in the wall. The effectiveness of this method is low.	Risk: this method is not meant to stop rising damp completely but to reduce the MC in the wall. The effectiveness of this method is low.	
6		Do you have a large budget available for this intervention (initial costs + operation + maintenance)?	No	Risk; very high initial costs but no running costs or maintenance.	OK; moderate initial costs but no running costs or maintenance.	OK; moderate initial costs and no running costs or maintenance.	Attention; apart from initial costs, take into account the running costs for the mechanical ventilation devices.	Risk; apart from high initial costs, expect high running costs as well.	
7		Is it acceptable if you cannot use the room for some time while/after the intervention is carried out?	Yes	OK; keep in mind that the intervention is quite rigorous.	OK; be aware that, depending on the product/solvent, you may not be able to use the room for a few weeks.	OK; the intervention does not take long to carry out.	OK; the intervention is on the outside and the wall is not affected.	OK; depends on the chosen method.	

FIG. 3.9 Screen shot of a section of the decision support tool prototype (the colour of the cell indicates the capability of a certain method to fulfil the requirement specified in the question)

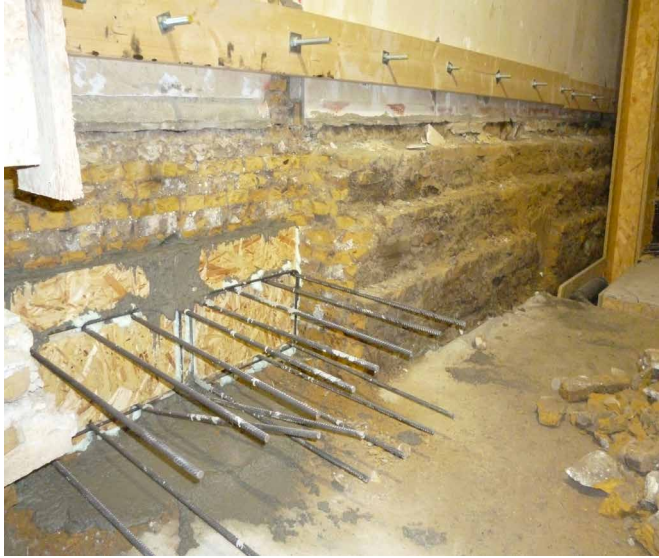

FIG. 3.10 Huis Nolet, basement: reinforcement for insertion of concrete floor (December 2016) / Photo: B. L.ubelli



FIG. 3.11 Huis Nolet, basement: temporary support of the wall during insertion of concrete floor (December 2016) / Photo: B. L.ubelli

Huis Nolet in Schiedam

In the renovation of Huis Nolet, a mansion in Schiedam, the Netherlands, dating back to the beginning of the 19th century, the restoration architect decided to carry out a mechanical interruption in order to tackle rising damp in the basement of the building, despite the high costs and difficulties of this type of intervention.

The reason for choosing a mechanical interruption of the wall, despite the difficulties in execution and the high costs, was mainly the need for a definitive solution. Moreover, the execution of extensive renovation works, including the reinforcement of the foundations and the addition of a concrete floor in the basement, made it possible to carry out the mechanical cut in the walls with a relatively small

additional effort. A concrete floor, originally planned to be inserted into the perimetral walls of the buildings at intervals of 50 cm, was made through the entire section of the wall [FIGS. 3.10/3.11]. The part of the walls in contact with the ground was protected with an impermeable layer in order to avoid sideward penetration of water. In this way an effective intervention against rising damp was obtained with relatively limited additional costs. This shows that for each situation a bespoke approach is required, defined by considering all aspects: even a complex and expensive intervention, such as mechanical interruption, may become feasible and suitable in specific situations.



FIG. 3.12 Interior of the Elleboog church: water used to extinguish a fire had accumulated on the concrete floor and risen up in the wall, leading to a moisture content distribution similar to that observed in the presence of rising damp from groundwater / Photo: B. Lubelli



FIG. 3.13 Excavation of the ground around the foundation of the church and sampling, at different depths and heights in the wall along a vertical profile, for the measurement of the moisture content and distribution / Photo: B. Lubelli

Elleboog church Amersfoort

A sound diagnosis of the moisture source is necessary prior to an intervention against rising damp. A small investment in preliminary research can save large investments in unnecessary and/or unsuccessful interventions. This is shown by the example of the Elleboogkerk in Amersfoort, the Netherlands. A fire destroyed the roof of the church. The fire was extinguished, and, after some time, a new roof was built and the walls were plastered again. A few weeks after the application, the plaster showed damage in the form of spalling. The Dutch independent research organisation TNO was asked to investigate the cause of the damage (Lubelli and Hees, 2012). During a first investigation of the moisture content in the wall, the lower part of the masonry was found to be very wet, suggesting the presence of rising

damp from groundwater [FIG. 3.12]. A further investigation of the groundwater level and of the moisture content in the soil, clarified that rising damp from groundwater was indeed present, but only up to a low height in the wall [FIG. 3.13]. The high moisture content (MC) measured in the wall in the interior of the church was not due to rising damp from groundwater, but to the capillary rise of water used to extinguish the fire, which had accumulated on the concrete floor of the church. No intervention against rising damp was thus necessary; after 6 months the walls were dry enough to be safely plastered.



Rising damp in wall / Photo: B. Lubelli



Exfoliation of brick / Photo: B. Lubelli

4 – Treatment of historic surfaces with water repellent and consolidation products: choices for intervention

Barbara Lubelli

4.1 – Introduction

Surface treatment on historic buildings, such as the use of water repellents or consolidation products, can have an irreversible impact on architectural heritage. However, decisions in this field are often taken without enough knowledge of the possible risks of such an intervention on the short and long term. This chapter explains the working principles of water repellent and consolidation products, provides an overview of classes of products and their development over time, and proposes a method to guide the user in the choice whether or not to apply a surface treatment and to select a suitable type of product for a given situation.

4.2 – Historic development of surface treatments

Attempts to preserve monumental surfaces from weathering date back to ancient times when natural products, such as waxes and oils, were used (Cennini, 1859; Secundus, 1962). It was mainly in the 20th century that synthetic chemicals replaced natural products. In the 1950s, inorganic products (e.g. barium hydroxide, alkalisilicates) were progressively substituted by silicon polymers. Nowadays, the trend is towards water-based products (more environmental- and user-friendly than traditional solvent-based products) and nano-structured products (Borsoi, 2017; Sierra-Fernandez et al., 2017). Technical trends in product development are clear and several reviews on this subject can be found in literature (e.g. Lewin, no date; Price, 1996; Doehne and Price, 2011; Siegesmund and Snethlage, 2011b).

The use of surface treatments has not only been influenced by the technical developments, but also by the (inter)national debate on conservation. The charters of Athens (Athens Charter, 1931) and Venice (Venice charter, 1964) recognized the necessity of monument preservation and approved the use of modern techniques, provided that their efficacy had been proven by scientific data and experience. This was seldom the case for surface treatments, the long-term effects of which were unknown in many cases of application. The Venice Charter implicitly introduced reversibility as a requirement for conservation interventions. However, most surface treatments turned out to have irreversible effects. The conflict arising from prescriptions of reversibility and needs of preservation, sometimes by irreversible interventions, has fed the debate on conservation during the 20th century. The development of the concepts of re-treatability and compatibility (Teutonico, 1997) reflects the attempt to overcome the dualism between theory and practice.

With respect to the Dutch situation, it is not fully clear up to which degree the debate on restoration ethics has actually influenced the use of surface treatments in the conservation practice. A research project carried out in the last years of the 1990's, involving Belgium, Italy and the Netherlands, highlighted a gap between theoretical positions and conservation practice and underlined the absence of a clear policy line; the authority in conservation matters often being entrusted to local bodies (Naldini et al., 1998). Nowadays, despite choices regarding surface treatments are left to the local authority, this often refer to a centrally approved position of the national conservation authority, the Cultural Heritage Agency (RCE). The position of the RCE and its predecessors towards the application of surface treatments, and in particular towards water repellents, seems to develop from the cautious approach in the 1960s to enthusiasm in the 1970s. In the 1980s, its position returned to being cautious: RCE publications (Schuit, 1986a, 1986b, 1994; Schuit and Polder, 1992) mention the risks of surface treatments, even though they do not

provide criteria for decisions. The theoretical issues related to loss of authenticity of materials due to surface treatments are first mentioned in 1994 (Helm et al., 1994) under the influence of the international debate (Nara document, 1994).

One of the problems emerging from conservation practice is the scarcity of information on the (long-term) effects of the different surface treatments applied to monumental surfaces. Product technical sheets are not informative enough and consequently it is hard to compare different products based only on the data reported by the producers. Product are rebranded and new products are often introduced on the market without sufficient preliminary testing of their (long term) compatibility and durability. Actors involved in conservation are not always fully aware of the effects of treatment on the behaviour of materials. This lack of sufficient knowledge favours the development of extreme, opposite attitudes towards the application of treatments. Nowadays in the Netherlands the application of surface treatments on monumental buildings is generally prohibited, while it is still commonly accepted and applied for building of less historic value. When considering the negative effects some treatments may have in the presence of some specific conditions on the durability of materials, a more conscious approach to the application of surface treatment would be desirable, also for non-listed buildings.

4.3 – Water repellent treatments

Definition

A water repellent treatment consists of the impregnation of a substrate with a product which creates a hydrophobic layer on the treated surface.

Aim

A water repellent treatment aims to prevent or reduce rainwater penetration and thus slow down those damage processes related to the presence of a high moisture content, such as biological growth, frost decay and sulfate attack. Besides, by keeping the surface dry it aims to reduce the soiling of surfaces.

Working principle

A water repellent treatment works by changing the contact angle between water and a building material: normally this contact angle is about 0° ; following the application of a water repellent, the contact angle becomes larger than 90° [FIG. 4.1]. Therefore, a material treated with a water repellent cannot absorb water by capillarity [FIG. 4.2].

Because of their effect on capillary transport of liquid water, water repellent treatments significantly modify the drying process of a material. The drying process of an untreated material occurs in two phases:

- 1 *by liquid transport to the surface*: the surface is wet and the drying front is at the surface;
- 2 *by water vapour transport*: when the moisture content becomes lower than a certain value (Critical Moisture Content), the surface is dry and the drying front recedes into the material.

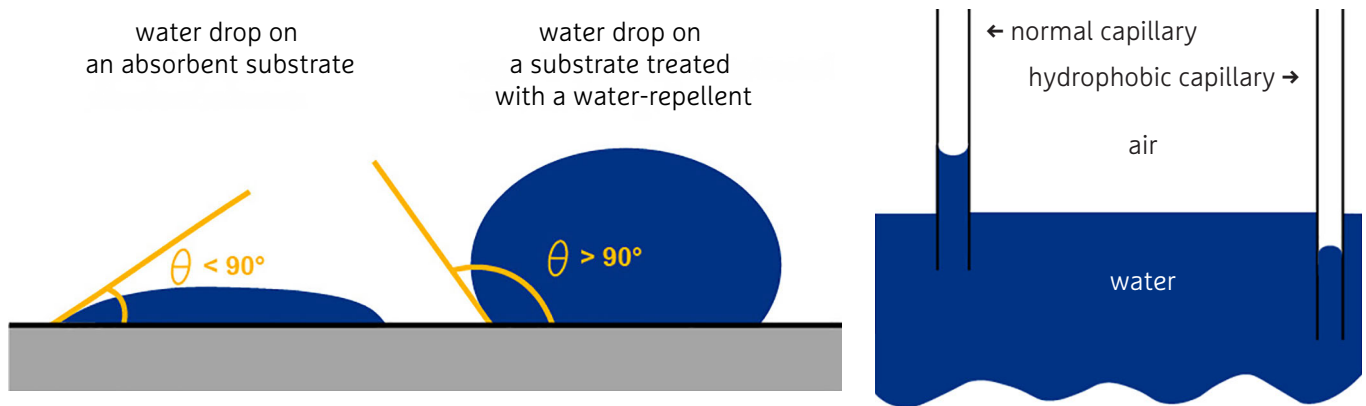

FIGS. 4.1/4.2 Behaviour of absorbent (hydrophilic) and water repellent (hydrophobic) materials

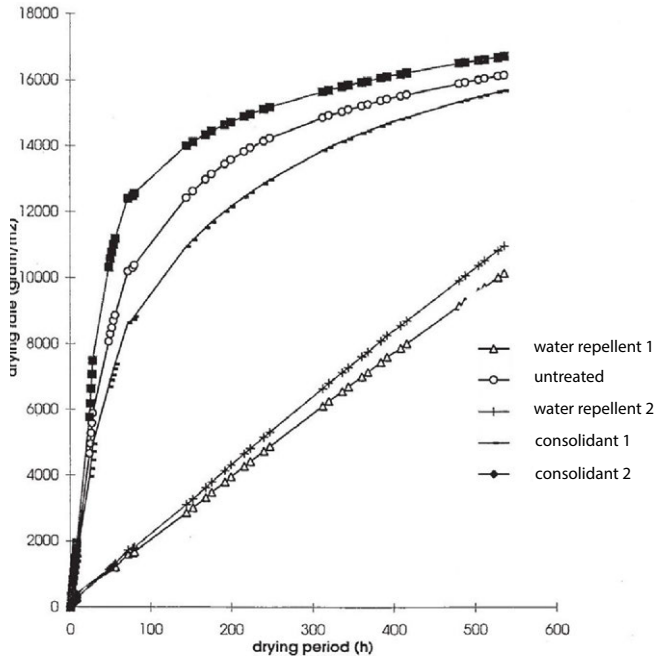

FIG. 4.3 Drying curve of a material: untreated, treated with water repellent treatments and treated with consolidation treatments (adapted from Hees et al., 1998)

Liquid moisture transport is much faster than the water vapour transport; therefore, drying occurs much faster in the first phase than in the second one. This is shown by the two different slopes of the drying curve of an untreated porous material [FIG. 4.3].

A water repellent treatment stops liquid moisture transport, while allowing water vapour transport. Therefore, a material treated with a water repellent will only dry by water vapour transport [FIG. 4.3] with a dramatic decrease of the drying rate as overall result. This may have negative consequences for some damage processes.

4.4 – Consolidation treatments

Definition

A consolidation treatment consists of the impregnation of a material with a product that, penetrating in depth, improves the cohesion of the decayed parts and the adhesion of these to the sound material beneath. The result is an improved resistance to the decay phenomena.

Aims

The main aim of a consolidation treatment is to improve the cohesion of the decayed part of the material and its adhesion to the sound material beneath. It is important to mention that consolidation treatments can be effective when the loss of cohesion occurs in the form of powdering or sanding [FIGS. 4.4/4.5]. A consolidant treatment is not effective in the presence of delamination and can even be harmful.

Working principle

A consolidant treatment works by (partially) filling the pores and the very thin fissures present in a decayed material [FIG. 4.6/4.7]. The (partial) filling of the pores and the recovered cohesion leads to an increase of the mechanical strength.

Consolidation treatments are normally applied in a fluid state in order to facilitate their penetration in the depth of the substrate. The applied fluid may solidify by cooling or, more often, it may set by chemical reaction or by evaporation of the solvent. Generally, a reduction in volume occurs during setting.



FIG. 4.4 Powdering of the stone: a consolidation treatment may be effective in this case / Photo: B. Lubelli



FIG. 4.5 Powdering of the stone: a consolidation treatment may be effective in this case / Photo: B. Lubelli

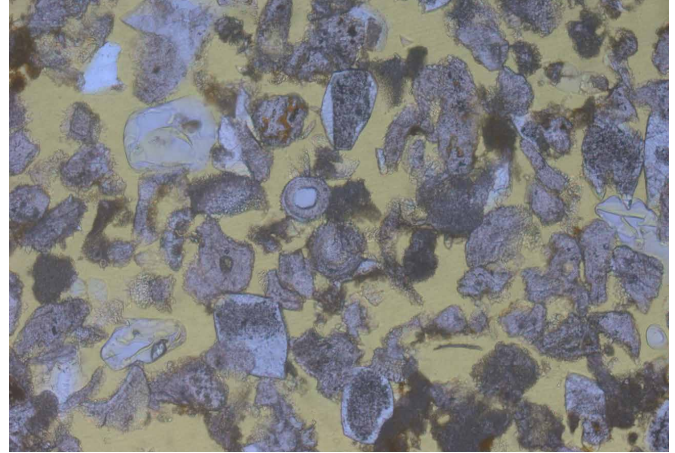

FIG. 4.6 Microphotograph showing deposition of silica gel in sound Euville limestone / Photo T.G. Nijland

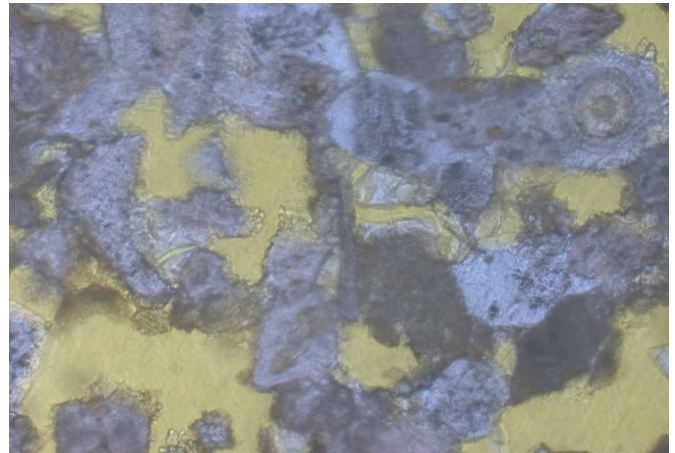

FIG. 4.7 Microphotograph showing deposition of silica gel in sound Euville limestone / Photo T.G. Nijland

The partial filling of the pores has an effect on the absorption and drying behaviour, as both the open porosity and the size of the pores decrease. Typically, the rate of capillary absorption and the total absorption of a material after consolidation is lower than that of the same material prior to consolidation. Similarly, the drying of consolidated material is slower than before treatment; however, liquid moisture transport remains possible. In general, the drying of a material treated with a consolidant is faster than that of the same material treated with a water repellent.

4.5 – Types of products

Water repellent products

The most commonly used water repellent treatments are silicone-based: silanes and siloxanes [TABLE 4.1]. The smallest molecules among silicon compounds are silanes (general formula $\text{Si}_n\text{H}_{2n+2}$). When the molecule comprises several silicon-oxygen bonds, the products are known as siloxane. Mixtures of silane and siloxane are often used. Thanks to their small molecules, silane and siloxane can penetrate the pores of the material (silane can even penetrate the very fine pores of concrete) where they react (polycondensation) to form large molecules and ‘attach’ to the pore walls of the material.

The main advantages of silane and siloxane products are their deep penetration, their good thermal and oxidative stability and their chemical inertia towards atmospheric agents.

In the last decades, different developments have occurred in this field. Next to liquid products, water repellent products in the form of cream have been developed: generally, these products have a higher percentage of active components and, thanks to their high viscosity which allows for a longer contact time with the substrate, can achieve a deeper penetration depth [FIG. 4.8] (Lubelli and Hees, 2004). Since the years 2000, water repellents in powder form have been introduced to the market, mainly as additives in dry mortar mixes, as e.g. salt accumulating renovation plasters for salt loaded substrates).

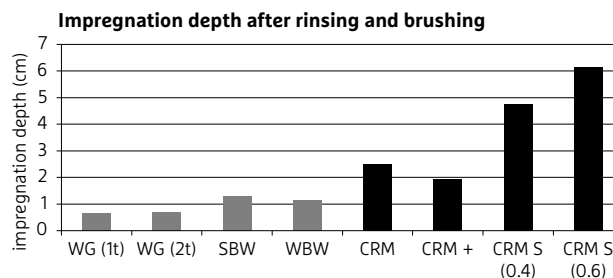

FIG. 4.8 Impregnation depth of different water repellent products applied to a fired-clay brick; liquid products are reported in grey, cream products in black.

TABLE 4.1 Historic development of water repellent silicone products (Lubelli et al., 2012)

YEAR	PRODUCT	SOLVENT	APPLICATION	% ACTIVE COMPONENTS
1960	Silicones	Hydrocarbon	Sandstone	< 5
1970	Oligomeric siloxanes	Hydrocarbon	Natural stone, brick	< 10
1980	Alkoxysilanes	Hydrocarbon	Idem and concrete	10-100
1990	Mixture of oligomeric siloxanes and alkoxysilanes	Hydrocarbon or water (emulsion)	Idem	< 10
2000	Further developments of mentioned mixtures	Idem or in the form of a cream, also in powder form	Idem; also as powder to be added to dry mortar mixes	25-80

4.6 – Consolidation products

Nowadays, the most widely used consolidation products are based on ethyl silicate (tetra-ethoxysilanes or TEOS). Ethyl silicate was originally developed in the 19th century but only commercialized on a larger scale in the field of conservation starting from the 1970s. The composition of TEOS has changed over time (in this case an evolution towards solventless products also has occurred) and nowadays several commercial products are available on the market. The reaction of these products with the substrate occurs as follows: the consolidation product penetrates the material and – when in contact with the water present in the substrate and after silanol formation through hydrolyzation – polymerises through a condensation reaction and forms nanometrical spherical particles of silicagel. The silicagel is responsible for the increase in strength in the consolidated stone (e.g. Zendri et al., 2007; Ferreira Pinto and Delgado Rodrigues, 2004). The main advantages of TEOS-based products are their good impregnation depth and water vapour permeability. Their main limitation is the shrinkage that occurs during the drying phase, which leads to very fine cracks and which may have negative consequences on degradation processes [FIG. 4.9]. Attempts to tackle this problem have been made by introducing elastified, nanostructured and hybrid silanes. Modified products have been also developed in which surfactants (Mosquera et al., 2008), or silane components and/or silica nanoparticles (Kim et al., 2009) are added to influence the sol-gel transition and thus reduce shrinkage.

Another problem of TEOS-based products is their low affinity with calcareous materials, such as mortars and limestones. In fact, as the final product of these reactions is silica-gel, TEOS-based products are most effective on materials containing silica, such as sandstone and bricks (Graziani, Sassoni and Franzoni, 2016). For the consolidation of calcareous materials, modified TEOS products have been developed by the industry.

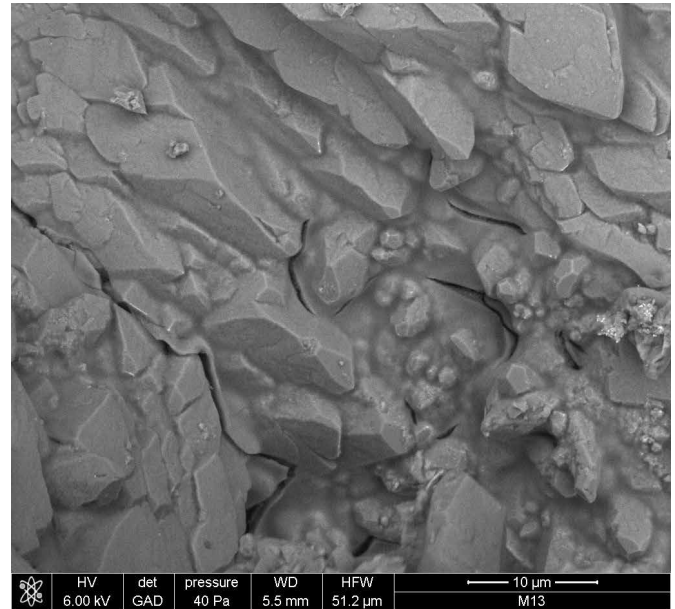

FIG. 4.9 Scanning Electron Microscopy (SEM) image showing shrinkage cracks in TEOS layer deposited in Euville limestone / Photo: TNO

Additionally, different alternatives have been proposed: calcium alkoxides (Natali et al., 2015), nanolimes, (Slížková and Frankeová, 2012; Zornoza-Indart et al., 2012; Chelazzi et al., 2013; Rodriguez-Navarro, Suzuki and Ruiz-Agudo, 2013; Licchelli et al., 2014; Borsoi, 2017; Otero et al., 2018), hydroxyapatite (Sassoni, Naidu and Scherer, 2011; Yang et al., 2012; Sassoni et al., 2013; Franzoni et al., 2015), etc. Most of these alternatives are still at the experimental stage, but nanolimes (i.e. Ca(OH)₂ nanoparticles in alcohol) have already been commercialized. However, from a recent literature overview of application of nanolime in practice (Borsoi, 2017), it has become clear that these products are presently more often used for works of art (e.g. fresco, statues) than for application on buildings.

Recent developments

Recently, both in the case of consolidant and water repellent products, research has been focused on the development of nanostructured products. These products contain active particles of nanosize, i.e. of the size of 10-9 μm . Often inorganic components, such as silica (SiO_2), alumina (Al_2O_3) or copper (Cu), are mixed for example to TEOS or polysiloxane (De Ferri et al., 2011; Ditaranto et al., 2011). The use of nanoparticles aims to improve the properties of the products with respect to traditional treatments (e.g. reduce shrinkage cracks (Mosquera et al., 2008) and/or to provide them with some additional functionalities (e.g. a biocidal effect) (Ditaranto et al., 2011).

4.7 – Decision process

To treat or not to treat?

When deciding on the application of a surface treatment, this choice should consider the specific situation thoroughly. A water repellent treatment might be possibly a solution for stopping rain water penetration. Differently, using a water repellent only for reducing soiling, might be ineffective in the long term and risky. In fact, the beading effect, which reduces the sticking of soiling to the treated surface, disappears after few years, while all the risks related to the application of a water repellent still remain. As surface treatments are generally irreversible, alternative solutions having a higher degree of reversibility should be considered first (Hees et al., 2014) [FIGS. 4.10/4.11].

For a good evaluation of a specific situation, the following aspects should be considered:

- *Effect of the treatment on the value of the object to be treated*: on one hand, due to the application of a surface treatment, the authenticity of the material will be partially but permanently altered; on the other hand, in the absence of alternative solutions, rejecting the application of a treatment may imply the permanent loss of the object due to further material degradation. A compromise between these two extremes can often be found in the choice of a compatible treatment.
- *Presence of moisture and source*: treatment of a surface with a water repellent product can be useful to avoid rain penetration, while it is useless and it can even become dangerous if another moisture source, such as rising damp, leakage etc., is present. In these cases, either the source should be eliminated prior to the application or, when this is not possible, alternative solutions to the application of a water repellent should be considered. A somewhat wet substrate is generally not a contraindication for the application of TEOS-based consolidant products. Inversely, the presence of water can be a contraindication for the application of dispersions such as nanolime or calcium alkoxides in alcohol, as water destabilizes the dispersion, creating the risk of too fast deposition of the particles on the surface and consequent whitening.
- *Presence of salts and source*: the presence of salts in the substrate is a contraindication for the application of not only water repellent (as this favours accumulation of salts at the treated/untreated interface with consequent spalling of the treated layer [FIGS. 4.12/4.13/4.14/4.15]) but also of consolidant products (TEOS may retain its water repellent properties in such cases for a long time). Depending on the source of salts and moisture, preliminary desalination of the substrate may offer a solution.

- *Condition of the substrate:* there are situations in which the state of conservation of the substrate constitutes a contraindication to the application of a treatment. For example, in all those cases where it is expected that the water repellent will fail to perform properly, e.g. because of the presence (or risk of development) of cracks (as for example in windmills, due to movement of the structure (Lubelli et al., 2007), it may be better to consider alternative solutions. Consolidant treatments can be applied to recover loss of cohesion (present in the form of powdering, sanding, chalking...) but they are not effective in the case of materials showing layering (in the form of exfoliation, delamination spalling or scaling). In these cases, adhesives and/or micro-grouting need to be used to re-join the layers together.
- *Other factors:* the presence of previous treatments can affect the decision on re-applying a treatment or not. Therefore, it is important to know whether a treatment has been applied in the past. For example, it happens frequently that a wall needs to be re-pointed or that damaged bricks need to be replaced. If the wall has been previously treated with a repellent, the dilemma arises whether the treatment should be re-applied or not after repointing or repair of the masonry. While, on one hand, the repaired, untreated part may favour drying of the masonry (and thus reduce the risk of frost and salt damage), it contributes to increase the absorption of rainwater, leading to a higher moisture content in the wall on the other hand. A recent laboratory experiment carried out on brick walls with different types of repointing mortar has shown that for the studied combinations and length of wet-dry cycles, the faster drying cannot compensate for the increased water absorption. Therefore re-application of a water-repellent is in most cases advised for treated masonry after replacement of the pointing (Nijland et al., 2019).



FIG. 4.10 A plaster layer for protection can be an alternative for a water-repellent treatment / Photo M. van Hunen



FIG. 4.11 A roof protection can be an alternative for a water-repellent treatment / Photo W.J. Quist



FIGS. 4.12/4.13 Salt accumulation beneath the layer treated with a water repellent (left) and subsequent spalling of the treated part (right) during a laboratory test / Photos: B. Lubelli

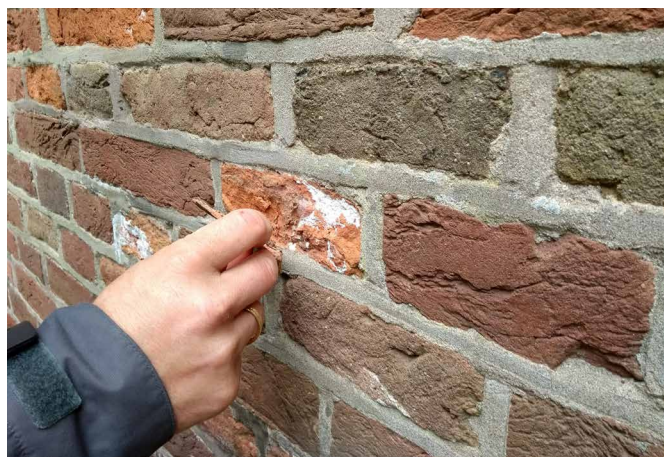

FIGS. 4.14/4.15 Spalling due to salt accumulation beneath the treated layer; the water repellent is still effective several years after the application / Photos: M. van Hunen

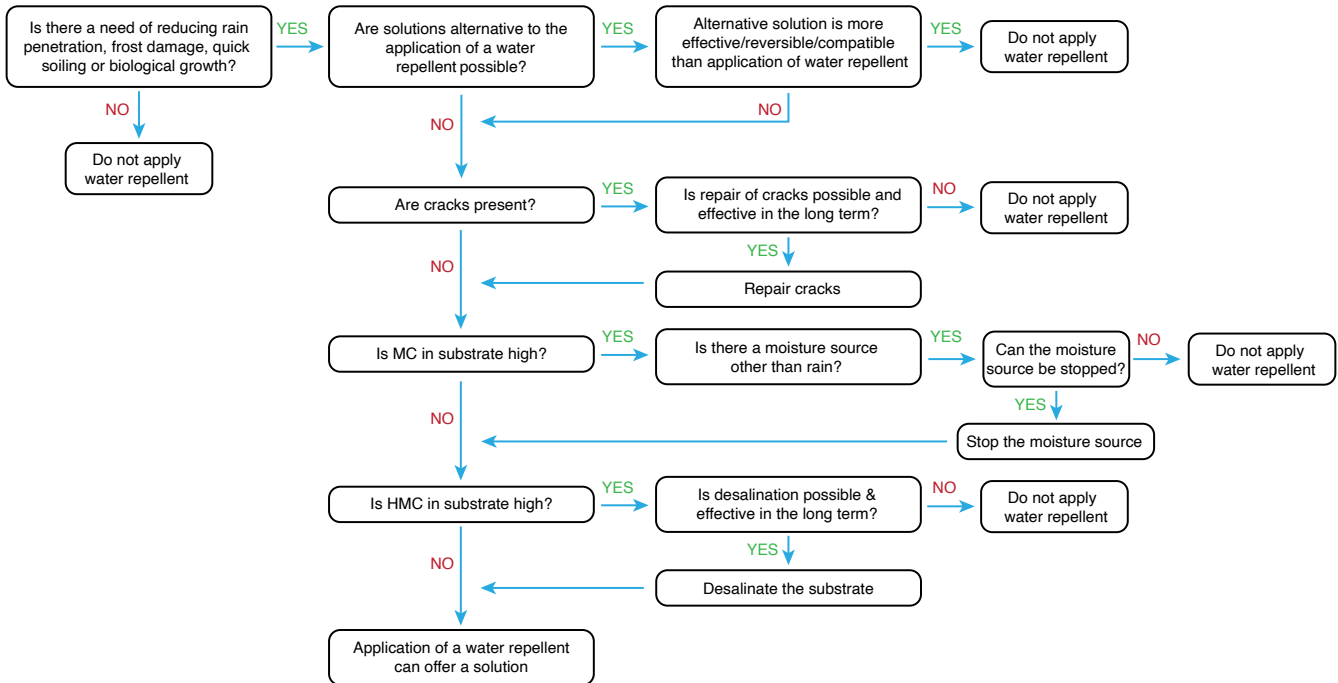

FIG. 4.16 Decision process regarding the application of a water repellent (wr) treatment. (MC = moisture content; HMC = Hygroscopic Moisture Content, which provides an indicative measure of the presence of hygroscopic salts)

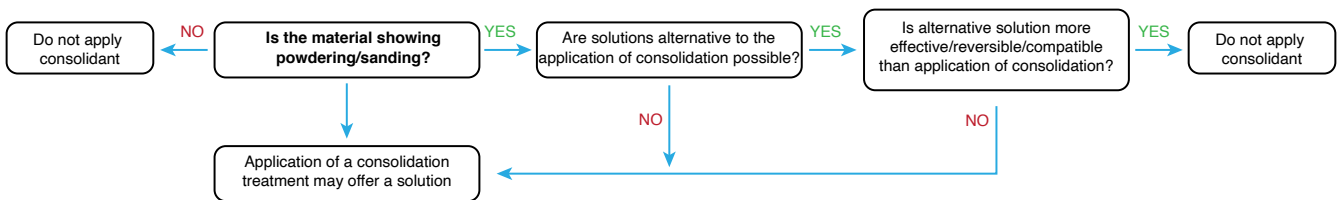

FIG. 4.17 Decision process regarding the application of a consolidation treatment

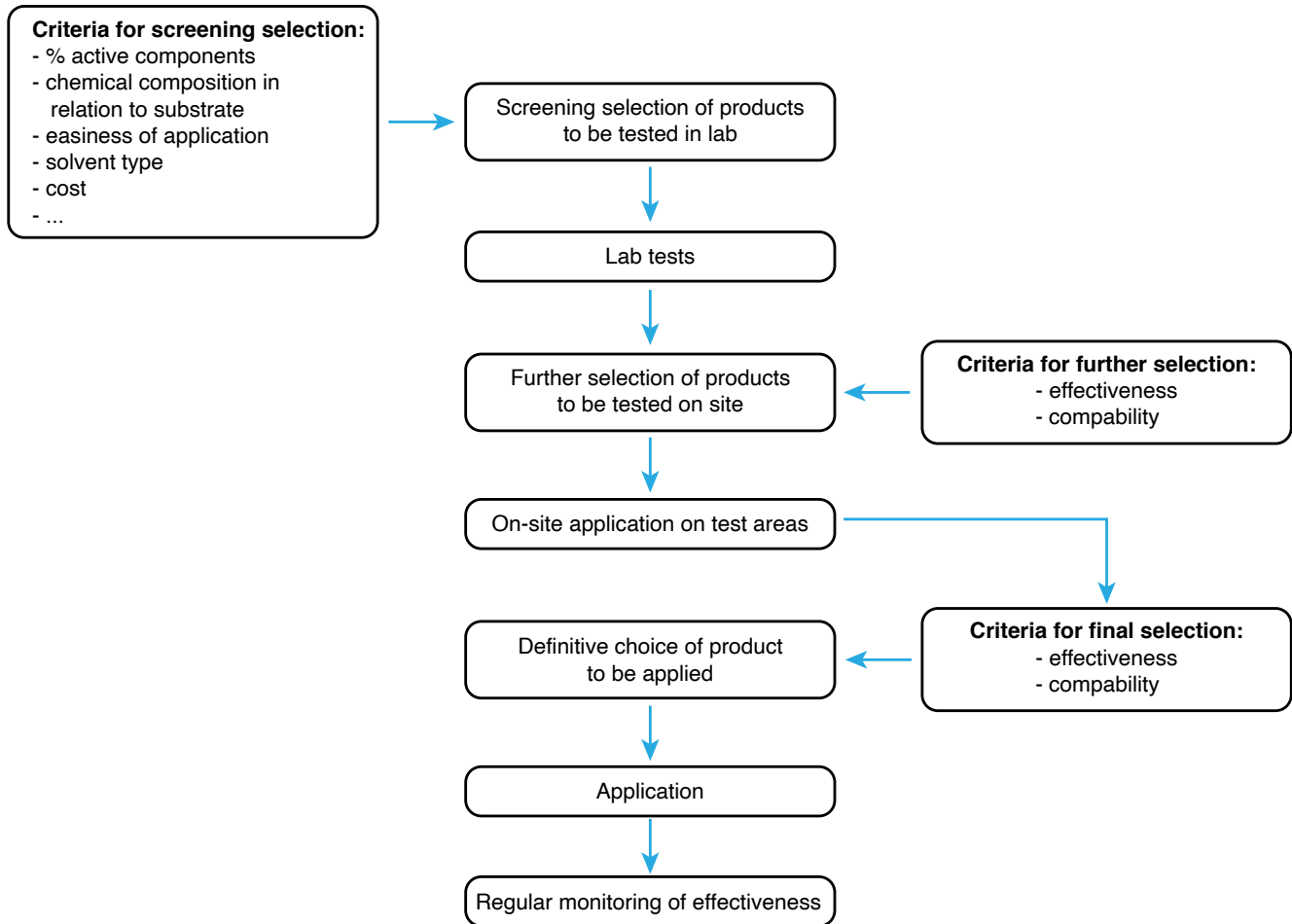

FIG. 4.18 Process for the choice of an effective and compatible surface treatment

How to select a suitable treatment

A first screening selection of a surface treatment product can be based on the information provided by the technical sheets and on the available knowledge of advantages and limitations/drawbacks of the different classes of products. Properties such

as percentages of active components, chemical composition in relation to substrate, ease of application and solvent type can guide a first selection of products to be tested in laboratory.

In a laboratory, the capability of the treatment to fulfil the requirements of effectiveness and compatibility should be assessed. Based on the results from the laboratory investigation, a further selection of few products to be tested on site on small areas can be made. Based on assessment of their compatibility and effectiveness when applied in the on-site conditions (e.g. moisture content of the substrate and environmental conditions may affect the behaviour of a treatment), a definitive selection of a suitable product can be made. This decision process is summarized in [FIG. 4.18]. The requirements of effectiveness and compatibility and how to assess them are discussed in the following sections.

Effectiveness

A water repellent treatment can be considered effective if it is able to stop capillary transport of water through the treated layer. The effectiveness of a water repellent to stop water ingress through the treated surface can be assessed in several ways. A first indication can be obtained by placing some water drops on the treated surface: in the presence of a water repellent a clear beading effect will be visible [FIG. 4.19]. As this beading effect disappears from the surface after some time (the products are degraded by the UV light), it is advised, in the absence of a clear beading effect, to assess the effectiveness a more reliable way. A more precise evaluation of the effectiveness can be obtained by the assessment of the absorption of the treated surface by means of capillary absorption measurement on a sample (in laboratory) or Karsten Tube test (on site or in laboratory) [FIG. 4.20]. The lower the absorption, the more effective the water repellent treatment can be considered. The impregnation depth can be assessed by splitting the treated material perpendicularly to the treated surface and wetting the broken surface. The treated part will be clearly distinguishable as it will remain dry and thus lighter in colour than the untreated part [FIG. 4.21].



FIG. 4.19 Method for the assessment of effectiveness of water repellent treatment: beading effect / Photo: B. Lubelli



FIG. 4.20 Karsten Tube test / Photo: R. van Hees



FIG. 4.21 Measurement of the impregnation depth / Photo: B. Lubelli

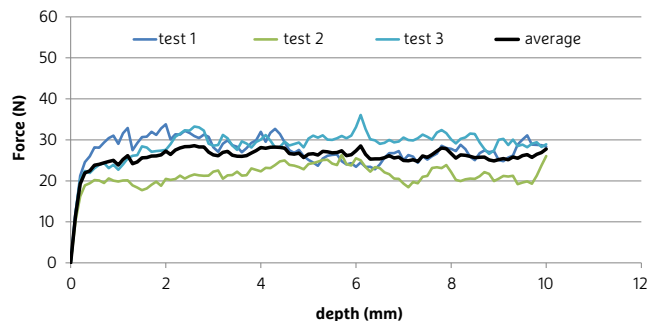

FIG. 4.22 DRMS measurements on sound Lede stone

For consolidation treatments, a recovery of the internal cohesion of the substrate confirms the effectiveness of the treatment. The most direct way to assess the recovered cohesion is by measuring the (tensile) strength of the material before and after treatment (Slížková et al., 2015). These measurements are destructive and can be complex; therefore, alternative methods such as the Drilling Resistance Measurement System (DRMS) are often applied. This test, which can also be applied on-site, consists of drilling a hole in a stone and measuring the penetration force needed as a function of depth (Fratini et al., 2007; Pinto and Rodrigues, 2008). This method can assess the distribution of the product in depth (e.g. Ferreira Pinto and Delgado Rodrigues, 2004; Matteini et al., 2011; Borsoi et al., 2017; Otero et al., 2018). The hardness of the treated surface, assessed before and after treatment, is often reported as a measure of the effectiveness of the consolidation. However, this might not necessarily give a measure of an improved internal cohesion in the material, but be only the result of an increased hardness due to the filling of the pores. Besides, as variations in the hardness of the substrate can be large [FIG. 4.22], a significant number of drilling holes is needed; this can be a problem in the case of measurements on valuable objects. Microscopy techniques (mainly Scanning Electron Microscopy, as optical microscopy

cannot reach a sufficient magnification) can provide additional information on the presence and even effectiveness of the treatment, as they make it possible for an expert eye to identify a more or less strong interaction of the particles with the substrate. Sometimes, a semi-quantitative method, the Scotch tape test, is used for the evaluation of the effectiveness of the consolidation, both in laboratory and on-site (Drdácký et al., 2012; Ruffolo et al., 2014; Slížková et al. 2015; Daniele et al., 2018; Otero, et al., 2018). This method, standardized in the ASTM D3359 (ASTM, 2017), can be useful to assess an increase of the cohesion at the very surface of a material, but it does not provide information on the effectiveness of consolidation in the depth.

Compatibility

In the specific case of surface treatments, the compatibility of a treatment can be defined as follows: a treatment can be considered compatible if it does not lead to technical (material) or aesthetic damage to the historical materials. At the same time, the treatment as such should be as durable as possible (Balén et al., 2005; Hees et al., 2017). Compatibility includes aesthetic, chemical, physical and mechanical requirements. Some class of requirements, such as aesthetic and chemical requirements, are common to both water repellent and consolidation treatments, some others are specific to one group only.

When considering aesthetical requirements, no visible change of colour (either discoloration or darkening) or change in gloss or in the visible surface structure of the substrate should occur due to the surface treatment. In principle this aspect can be assessed by visual observation [FIG. 4.23]. More detailed information on colour changes can be obtained by means of a colorimeter, following e.g. the standard EN 15886:2010 (CEN, 2010). Besides, the treated surface should not become sticky, as this can cause dust and dirt particle to adhere and lead to soiling of the substrate.



FIG. 4.23 Maastricht limestone 1 day after the application of different consolidation products: product 2 and to a lesser degree product 1, have caused whitening of the surface / Photo: B. Lubelli

For a good chemical compatibility, harmful chemical reactions between treatment and substrate and between treated substrate and dirt particles, salts, etc. should be avoided. For example, sodium and potassium silicate consolidants, which were commonly used in the past, are nowadays not used anymore because of the risk of formation of soluble salts following their application (Siegesmund and Snethlage, 2011a).

Physical compatibility includes requirements related to thermal and hygric dilation and moisture transport properties. The effect of a surface treatment on the hygric and thermal dilation of the treated materials should be nihil or very limited in order to prevent damages such as spalling of the treated zone. Especially in the case of hydrophobic treatments applied on clay-rich stone, their effects on hygric dilation need to be checked, as it has been shown that they can be relevant (Siegesmund and Snethlage, 2011a). The effect of the treatment on the thermal and hygric dilation can be assessed by comparing the dilation of treated and untreated substrates (for example according to EN 13009:2000 (CEN, 2000)).

Regarding the transport moisture properties, the requirements are different for water repellent and consolidation treatments, as the first are supposed to change some of these properties, whereas the second should do this as little as possible. In the case of water repellent, the water absorption by capillarity at atmospheric pressure (as measured by the capillary absorption test) and a low pressure (as measured by Karsten Tube test) should be reduced as much as possible. At the same time, the treatment should not significantly reduce the water vapour transport: in fact, as this is the only drying mechanism possible in a treated material, reducing it would further delay or inhibit the drying. Snethlage and Sterflinger in (Siegesmund and Snethlage, 2011a) report that the water vapour diffusion resistance should not increase for more than 20% with respect to the untreated substrate. In the case of consolidation treatments, the water transport properties of a treated material should not change too much compared with those of the untreated material: these properties include the capillary water absorption, the water vapour diffusion resistance and the hygroscopic adsorption behaviour.

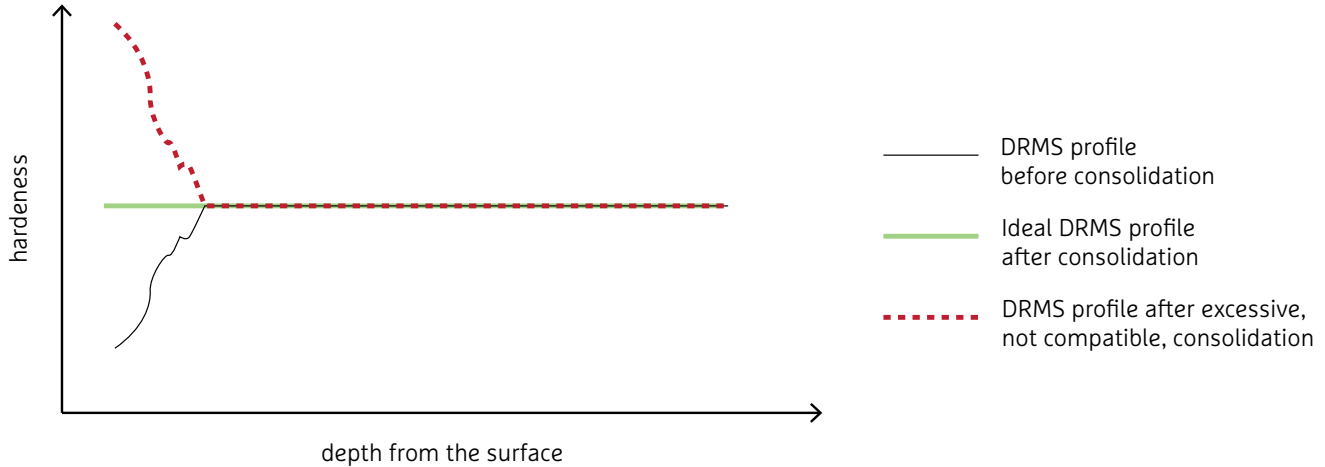

FIG. 4.24 After consolidation the stone should ideally recover its initial hardness (green DRMS profile)

Mechanical compatibility requirements demand that the treated layer has similar mechanical properties to those of the untreated part, i.e. no hard layer should be formed at the surface. This is a risk in the case of consolidation treatments, as these are meant to partially fill the pores and improve the hardness and cohesion of the decayed zone. For a consolidation to be compatible, the 'hardness' of the decayed, treated material should be not much higher than that of the sound material [FIG. 4.24]. A difficulty in assessing the compatibility, and in particularly the mechanical compatibility of consolidation treatment, is presented by the fact that tests are generally carried out on sound specimens, whereas consolidation treatments are supposed to be applied on decayed substrates. This has two main consequences:

- the transport of the treatment into the substrate might be different, as the porosity and pore size of the decayed substrate are generally higher and larger than of those of the sound substrate. This may affect the depth reached by the treatment and its distribution.
- It is hard to define how large the increase in mechanical properties of the treated layer can be in order to avoid damage. Attempts to define these values and the rate at which they should change have been made (Siegesmund and Sneathlaga, 2011a); however, the validation of these criteria in practice is still pending.

How to assess the presence of a water repellent treatment on-site

Sometimes it can be useful to determine the presence of a water repellent, as this can clarify some damage processes and decay patterns and it can affect the decision whether or not to treat a section of masonry or an object. In the following paragraphs the different steps in the investigation process are described and summarized in a diagram [FIG. 4.25]. A first, simple test to assess the presence of a water repellent is to spray some water on the surface to be tested. If a beading effect is visible, a water repellent treatment is present. As silicone-based water repellents are degraded by UV light over time, the presence of a clear beading effect at the surface suggests that the treatment is relatively recent (few years). The presence of algae may give a water repellent effect. In the case of algae growth on the surface it is therefore suggested to not rely on the beading effect only but to carry out further investigations.

Should the water repellent be some years old, it might have been degraded at the very surface because of the effect of UV light; in this case no beading will occur. It is therefore advised to carry out a Karsten Tube test, also when the beading effect is not visible. The Karsten Tube consists of a graduated glass tube welded at its lower part on a cylinder cell. The tube is filled with water stepwise and the absorption of the masonry measured over time. The water column simulates the pressure exerted by driving rain. The description of the procedure can be found in (Hees, 1998).

In the execution of the test and in the interpretation of the results the following aspects need to be taken into account:

- it is important to consider the absorption expected for an untreated material of the same type as the one to be tested. For example, a very low absorption measured on low porous stone is not necessary a sign of an effective water repellent treatment, but the normal behaviour of the stone. In the case of stones with a very low absorption, the ‘contact sponge method’ (Vandevoorde et al., 2009) may provide more precise and conclusive results than the Karsten Tube test.
- the presence of soiling, occluding the pores of the material at the surface, may result in low absorption also in the absence of a water repellent (see insert Atlantic huis). In such cases, the soiling should be removed as much as possible before performing the test.

If doubts persist, sampling of material and additional tests in laboratory might be necessary.

In a laboratory, the presence and effectiveness of a water repellent can be further checked by measuring the water absorption by capillarity through the treated surface. The advantage with respect to the Karsten Tube test is the possibility of comparing the absorption through the outer (treated) part to that of the inner (untreated) part. Besides, when a core sample is available, the impregnation depth reached by the treatment and the possible variation of its effectiveness in the depth can be checked. The first can be checked by wetting the core: the treated part will not get wet and remain of a lighter colour than the rest of the material [FIG. 4.26]; the second can be checked by observing the shape of water drops at different depths, from spherical to more elliptic.

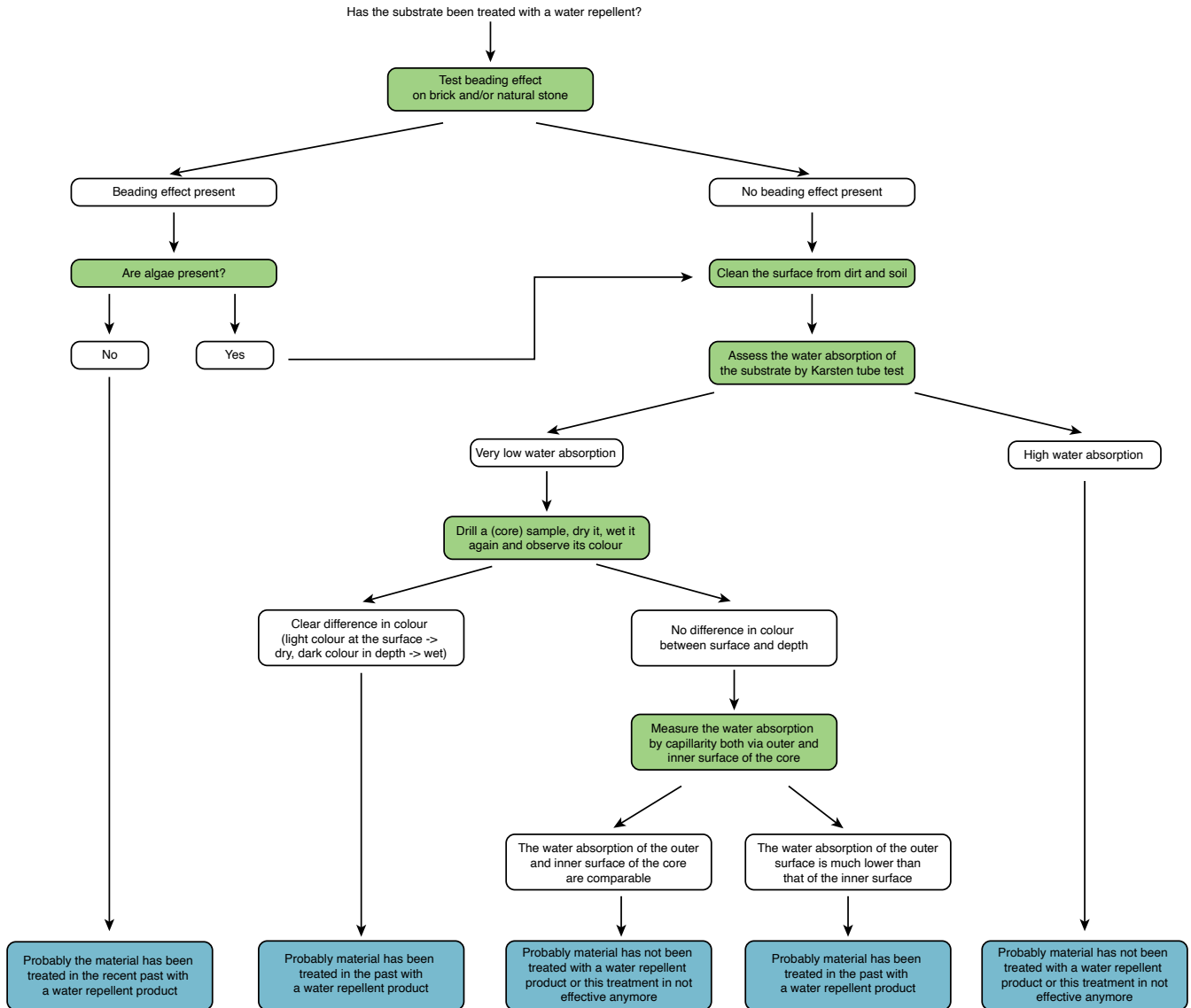

FIG. 4.25 The decision tree presented here shows how to assess the presence of a water repellent treatment



FIG. 4.26 The penetration depth of a water repellent treatment has been assessed by wetting a cross section of the sample with water: the light part corresponds with the treated layer / Photo: B. Lubelli

Atlantic House in Rotterdam - Decision about the application of a water repellent

The Atlantic House is a monumental building in Rotterdam, the Netherlands, dating back to 1928-1930. It has a concrete structure and brick masonry fillings. In 2008-2009 the building, was renovated and converted to housing. Cleaning of the façades was planned as part of the renovation. Cleaning may lead to an increase of water absorption (as it removes the soiling filling the pores at the surface) and consequently to water infiltration, which in this case could be particularly risky for the corrosion of the reinforced concrete structure. Therefore, the option of applying a water repellent treatment following the cleaning of the façade was considered and the risks of this intervention were evaluated.

Two test areas were prepared: one was only cleaned, the other was cleaned and treated with a water repellent product. The water absorption of the masonry of both test areas was measured by a Karsten Tube test and compared to that of the not-cleaned masonry [FIGS. 4.27/4.28]. Moreover, the presence,

amount and type of salts in the masonry were assessed, as salts constitute a contraindication to the application of a water repellent treatment.

The results of the Karsten Tube tests [TABLE 4.2] show that the masonry before cleaning had a very low absorption. Cleaning significantly increased the water absorption; the subsequent treatment with a water repellent was able to reduce the water absorption to nihil. However, the results of the salt analyses showed the presence of a high salt content in the masonry. Based on these results it was advised to reconsider the need for cleaning the masonry.



FIG. 4.27 Execution of the Karsten Tube tests on the masonry not cleaned (left), cleaned (middle) and cleaned and treated with a water repellent (right) / Photos: B. Lubelli



FIG. 4.28 Salt efflorescence, evidence of the presence of salts in the masonry, further confirmed by chemical analyses / Photo: B. Lubelli

TABLE 4.2 Water absorption measured by Karsten Tube test - step 1

MATERIAL	BEFORE CLEANING				AFTER CLEANING		AFTER CLEANING & APPLICATION OF WATER REPELLENT	
	brick. soiling	brick. soiling	brick. little soiling	brick. little soiling	brick	brick	brick	brick
Method 1								
step 1	v	v	absorbs	absorbs	absorbs	absorbs	v	v
step 2	v	v					v	v
step 3	v	v					v	v
step 4	v	v					v	v
step 5	v	v					v	v
Method 2								
5 min	0.2	0.1	2.4	2.2	Full abs. in 4'46"	0.95	0	0
10 min	0.4	0.2	Full abs. in 9'42"	3.1		1.7	0	0
15 min	0.6	0.3		Full abs. in 13' 51"		2.45	0	0
WA-K (ml)	0.4	0.2				1.5	0	0

WA-K: water absorption measured by Karsten Tube = absorption after 15 minutes – absorption after 5 minutes; V = no absorption



Rusting iron / W.J. Quist

5 – Conservation of windows and glazing

Uta Pottgiesser & Susanne Rexroth

'The loss of traditional windows from our older buildings poses one of the major threats to our heritage' (Pickles et al., 2017, p.1)

5.1 – Introduction

A window is an 'opening especially in the wall of a building for admission of light and air that is usually closed by casements or sashes containing transparent material (such as glass) and capable of being opened and shut' (Merriam Webster, 2021). Until medieval times windows were openings closed by leather, fabric or wooden shutters in most parts of Europe. Windows are essential functional elements of a building and, at the same time, they are comprehensive architectural and design elements of the massive building envelope. As a building component, the window has to fulfill a wide variety of tasks and requires the collaboration of different craftsmanship techniques in its manufacture. The diversity of the historical, national and regional types of windows is large and as diverse as architecture in general (Koolhaas, 2018). They represent different design characteristics depending on time and region and they include technical and structural developments that respond to different functional requirements, e.g. impermeability, ventilation possibilities, light permeability and operability. Despite or precisely because of this diverse functionality and significance, windows are subject to a

particularly high pressure for change (VDL, 2017). Similar to other heritage authorities, Historic England has stated that unsympathetic replacement of windows and doors represents the number one threat of heritage buildings, and that this affects no less than 83% of defined conservation areas (Pickles et al., 2017, p.1). Traditional windows are threatened for many different reasons: they are often completely replaced to improve a building's energy efficiency, even when simple technical and thermal upgrading options (e.g. draught-proofing, secondary glazing, shutters) would be also feasible at much less cost. Other reasons are safety and security requirements, material decay or the simple wish for change and modernization.

This contribution focusses on the historic values of windows and their conservation and refers to the experiences, approaches and recommendations of heritage authorities in England, Switzerland, Germany and the Netherlands. All of them emphasize the importance of windows as resource for the overall appearance and significance of buildings.



FIG. 5.1 Historic glazing / Photo: M. Olmeda

GLASS IN MONUMENTS

Glass panes in old buildings are different and each of them is unique: their appearance, the context in which they are used, their reflections and possible distortions, should be taken into account for the chronological and significance assessment. The aim is to preserve them, as they belong to our heritage.

5.2 – Material and construction

Glass history and types

Early glass produced from 3500 BCE until 50 CE was mainly used for jewelry and artisanal objects. The Romans recognized further functional uses of glass, namely for glazing their windows. The oldest known window pane in situ can still be visited in the Thermae in Pompeii (buried under ash and pumice in the eruption of vulcan Vesuvius, in 79 CE). After the fall of the Roman Empire around 476 CE, glass production in Europe continued, but on a much reduced scale (in Gallia and the neighborhood of Cologne for instance) as a product for the elite. By creating large, glazed openings, Gothic architecture played an important role in preserving many of the achievements of the Romans – both through safeguarding artefacts and fabrication techniques. Early medieval window glass is well known from archaeological sites of churches

and palaces all over Europe. However, it was mainly applied in stained-glass windows and only produced in small size and quantities.

Being an expensive and exclusive material, very few residential buildings made use of it in medieval times. Glass as flat glazing became a standard element of window constructions during the Renaissance in the 15th-16th century. It replaced other translucent materials such as alabaster or the use of only wooden shutters to fill the window opening. It was only in 19th century that the industrialization of glass production made glass affordable for general application in the building sector.

Hereafter, the most common types of glass are briefly illustrated and their fabrication process explained (Wigginton, 1996 and Schittich et al., 2021). When found in monuments, the types of glass from the past should be identified and analysed and, if possible, protected [FIG. 5.1].



FIG. 5.2 Roman glass from the German site of Haselburg / Photo: https://de.wikipedia.org/wiki/Datei:Haselburg_Glas.jpg 2007, accessed Aug. 2021



FIG. 5.3 The term 'bull's eye' refers to the thicker centre area of crown glass around the pontil mark / Photo: RCE



FIG. 5.4 Crown glass was one of the most common glass types until 19th century / Photo: pixabay.com

Crown Glass (400 CE onwards): to make crown glass, a bubble of glass is transferred from the blowpipe to a pontil iron and after perforating the glass balloon, is spun at high speed so that the centrifugal force causes it to flatten into a round 'crown'. The central piece, the 'bull's eye' was often used for cheaper (domestic) windows. Crown glass was one of the most common processes for making window glass in Europe until the 19th century [FIGS. 5.2/5.3/5.4].

Cylinder Glass (1080 CE onwards): to make cylinder glass a bubble of glass is manipulated into a cylinder by spinning it around. After cutting this elongated bubble open on both sides, the remaining cylinder was cut open along the length, and gently reheated and pressed flat to form a sheet. Like crown glass, this method was commonly used until the end of 19th century [FIG. 5.5].

Stained glass (1080 CE onwards): coloured and painted glass not only adds light but also beauty to medieval churches. Setting glass in (strong yet malleable) lead required skilled craftsmen. Lead as matrix for glass pieces however was already known to the Romans [FIG. 5.6].

Polished Plate Glass (1665 CE onwards): made by first pouring molten glass on to a table and rolling it until flat, then grinding and polishing it into a plate. Advancements in the process led to feeding the molten glass through continuous rollers, grinders and polishers. Plate sheet glass is no longer produced commercially in most European countries. As splendor had become a fundamental requirement, a whole new branch of industry could develop: the large scale production of polished plate glass. To get perfect flat and smooth panes, the cast glass has to be polished. This is a very time consuming and elaborate process. Glass has to cool slowly or it will crack due to internal stress. This very expensive glass type was for long only used for very specific buildings (both for windows and mirrors). Being almost undistinguishable from the best quality of modern industrially made float glass, it was also used for big shop windows into the 20th century [FIG. 5.7].



FIG. 5.5 Cylinder glass was another common glass types until 19th century / Photo: RCE



FIG. 5.7 Amalienburg hall of mirrors at Parc Nymphenburg (Munich) built in 1739 / Photo: https://en.wikipedia.org/wiki/Amalienburg#/media/File:Amalienburg_Spiegelsaal-1.jpg, accessed Aug. 2021



FIG. 5.6 16th century leaded glass in St. Johns' cathedral Gouda / Photo: S. Naldini



FIG. 5.8 Bauhaus Dessau, staircase, office and workshop glazings were originally using polished plate glass to achieve a precise and industrial look / Photo: pixy.org



FIG. 5.9 Wire mesh glass, Lochal Tilburg / Photo: W.J. Quist

From the 19th century onwards, the demand for better quality, cheaper and faster produced glass rose. Around 1900, Art Nouveau, Art Deco and modern architecture made use of more and larger window panes, for shop windows, commercial and residential buildings [FIG. 5.8]. Pender and Godfraind (2011, p.431) point out that 'many special forms of decorative glass were developed over the course of the 20th century', some of them are introduced here: pigmented structural glass, pressed and prism glass, patterned glass, drawn and float glass. For a timeline see FIG. 5.13.

Wired Cast Glass (1898 onwards): also known as Georgian Wired Glass or Wire Mesh Glass is a glass with safety and fire-resistant abilities, first patented by Frank Shumann in the USA in 1892 and first produced by Pilkington in 1998. The wire mesh embedded into cast glass helps the glass to stay in place when breaking. It does not necessarily conform with current standards and regulations for safety glass [FIG. 5.9].



FIG. 5.10 Vitrolite spandrels at former Daily Express building by Ellis and Clark, 1932, London / Photo: https://en.wikipedia.org/wiki/Daily_Express_Building,_London#/media/File:Express_Building.jpg, accessed Aug. 2021

Pigmented Structural Glass (1900 onwards): is a high-strength, coloured glass developed in 1900 in the United States by adding fluorides into the molten glass, which made the glass opaque. It was widely used in interiors, for signs and partitions and as facade cladding in the first half of the 20th century. Manufactured first in white, black or beige and later in a variety of colors, in flat panels or curved, it could be opaque or translucent, with a wide range of finishes: carved, cut, inlaid, laminated, sandblasted and textured. It was produced until the early 1960s in the US and until later in the UK and Europe. It was most commonly known under its trademarked name 'Vitrolite', but it was also sold as 'Argentine', 'Carrara glass', 'Glastone', 'Marbrunite', 'Nuralite', 'Opalite' or 'Sani Onyx' or as 'Detopakglas' in Germany [FIG. 5.10].

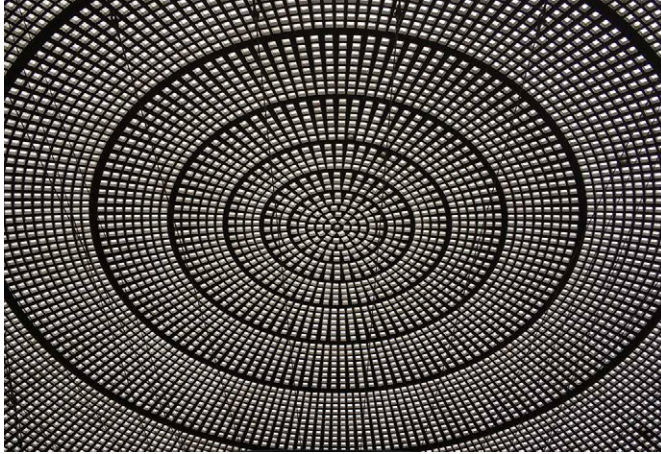

FIG. 5.11 Pressed glass, Ravenstein gallery Brussels / Photo: W.J. Quist

Pressed Glass (1900 onwards): is used to make glass blocks (or bricks), concrete glass and glass roof tiles and was first produced as blown hollow glass bricks by the French glazier Gustave Falconnier or as prismatic blocks by the German company Luxfer Prismen Gesellschaft. It was only in the 1930s that Saint-Gobain and the Owens Illinois Glass Cooperation pressed the viscous glass mass in a mould. This produced open glass bodies that are welded together to form a glass block allowing for a good homogeneous translucent illumination of interiors [FIG. 5.11].

Patterned Glass (also Textured Glass, 1919 onwards): is cast and rolled flat glass that gets its shape and its special patterned surface through a rolling process. The liquid glass mass is passed through structured rollers whose patterns are then reproduced in the glass. The uneven surfaces result in less transparent, but always translucent glass. The translucency depends on the density of the patterns. It provides a high level of light transmission in combination with privacy (sight reduction). It was often used in industrial context and in interiors [FIG. 5.12].

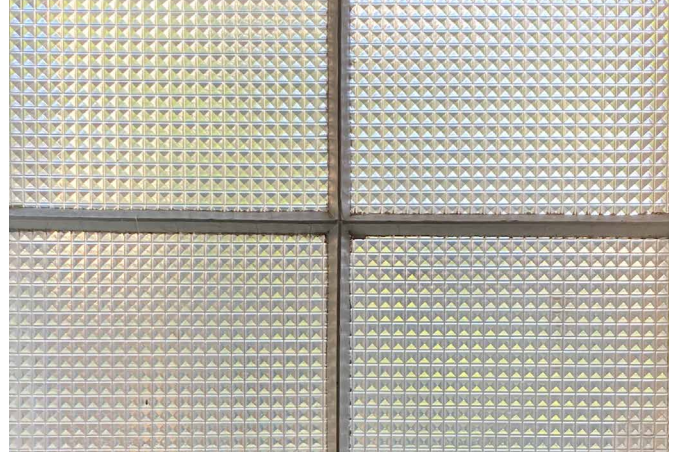

FIG. 5.12 Patterned glass, F.W. Braat's office, 1932, Delft / Photo: W.J. Quist

Drawn Glass (1913 onwards): was produced by drawing out vertically and then cooling semi-molten glass through a series of metal rollers set up on automatic machinery. This process, known as the Fourcault process, was invented by Émile Fourcault (Belgium) using the debiteuse. In parallel, Irving Colburn developed a similar drawing process where the glass was drawn horizontally. In 1913 the Libbey Owens Sheet Glass Company started producing large quantities of drawn sheet glass. The methods were used all over the world until the 1970s. Both processes cause slight irregularities on the glass surface (referred to as 'roller waves'), which distort light and lead to non-specular reflections that are particularly apparent when the glass surface is viewed tangentially.

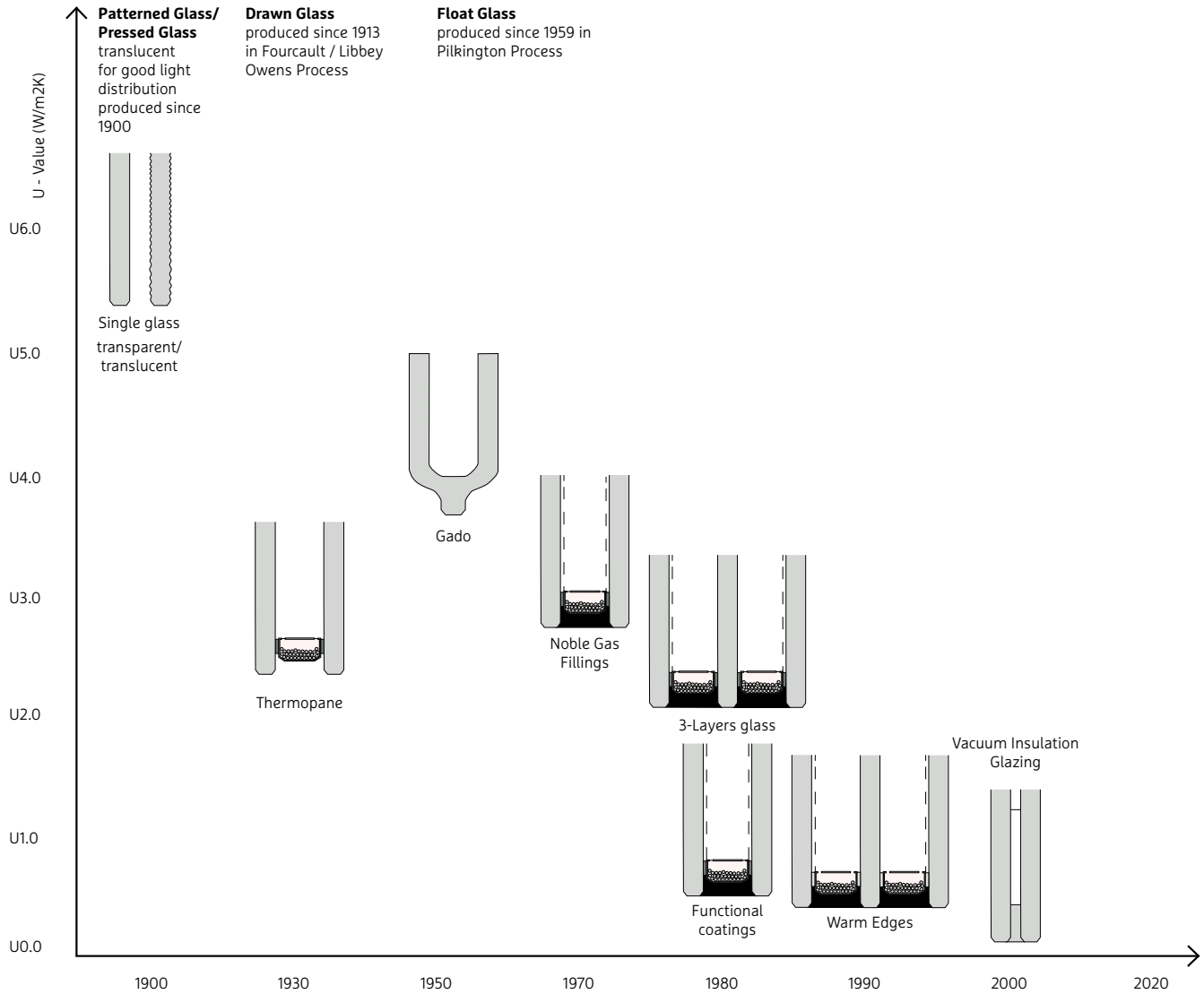

FIG. 5.13 Timeline of modern glass and glazing developments since 1900

Float Glass (also Annealed Glass, 1959 onwards): invented by Sir Alastair Pilkington in 1952, the float glass process was used to make flat glass without the 'roller wave' surface irregularities characteristic of drawn glass. The process was put into practice in 1959. Molten glass from the furnace flows by gravity and displacement onto a bath of molten tin, forming a continuous ribbon. From here it is led onto guiding rollers, which run it through an annealing furnace (lehr) where it is cooled under controlled conditions. It is characteristically flat, with virtually parallel surfaces and a smooth, even finish. Float glass that has not been heat-treated is referred to as annealed glass, different from tempered and heat-strengthened glass. Today, over 95% of window glass produced is using the float process.

Restoration Glass: a term used for different types of machine-drawn glass types that resemble historic glazing (SCHOTT AG, 2019, 2020). They are available under different names and produced by different companies up to 3.00 m and in 4 mm or 6 mm thickness. All restoration glass can be processed into insulating glass, laminated glass or toughened safety glass. Also blown window glass produced through traditional processes - e.g. slug, plate and cylinder technology - is still produced in a few glass factories in Europe.

Functional Glazing (1930 onwards): glass panes - mainly drawn and float glass - can be further coated, heat-strengthened, laminated, assembled into insulation glass units (IGU) or vacuum insulation glass units to improve thermal, mechanical or safety properties.

Glass Composition

Soda Lime Silicate Glass: is the most used glass in construction today. It has a greenish colour - particularly visible in thicker glass panes - due to traces of iron oxide present in the quartz sand.

Low-iron Glass: by using quartz sand with a low iron oxide ratio, any green colouring can be almost eliminated. This type of high-clarity glass and is also referred to as low-iron oxide glass or white glass.

Borosilicate Glass: adding boron (13% boric oxide) to the manufacturing process, results in glass with a very low coefficient of thermal expansion and more resistant to thermal stresses. While mostly used in laboratories, for electronics, cookware, optics or lighting, it is also manufactured as flat glass for use as fire protection in the construction sector.

Window History and Types

Windows discussed in this book are fixed or openable units with sash and frame constructions and single or multiple glass panes. They are mainly categorised here by their construction, function and design. The European standard (European Committee for Standardization EN 12519, 2018) describes windows terms officially used in EU Member States. The main construction types and glazing bars are mentioned there:

- fixed lights and fixed windows
- pivoted windows
- sash windows
- sliding, projecting and casement windows
- tilt and turn windows
- louvered windows
- folding windows
- glazing bars

Depending on their function and location, roof windows and lanterns, bay and oriel windows, French and witch windows or emergency exit windows can be distinguished. The number of glass panes is relevant to their thermal properties and their contribution to heat transfer: historically single and double-paned windows are known; triple - and quadruple - paned windows are commonly used for new constructions.

Windows Timeline

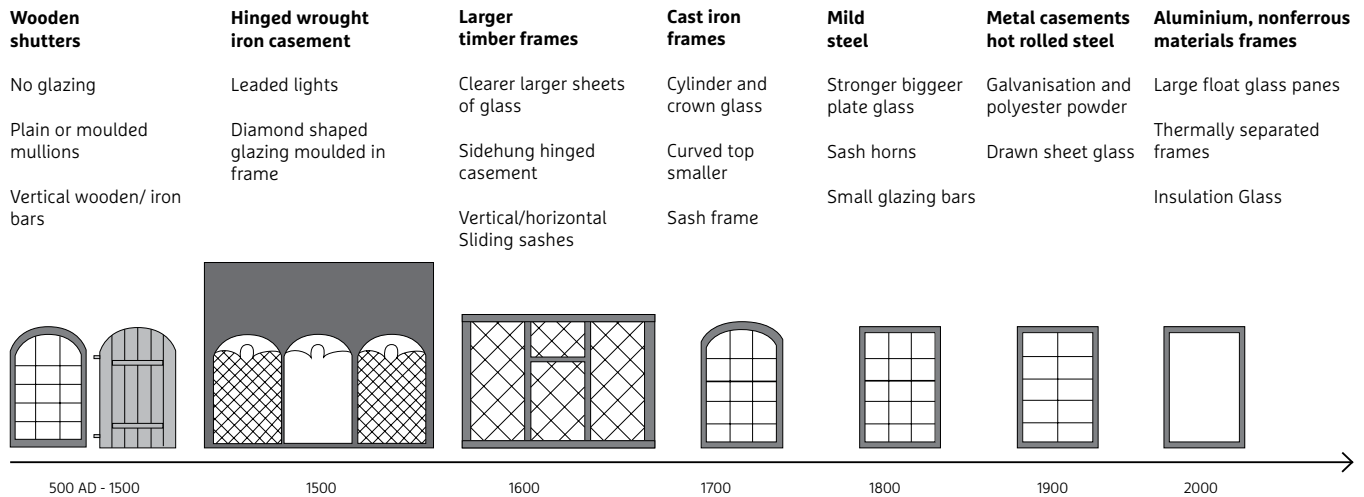

FIG. 5.14 Timeline of window development since 500 BCE

The historic development of windows and of the materials used is important in the heritage context. The main materials used for sash and frame constructions until the 19th century were wood and wrought iron [FIG. 5.14]:

- 12th -15th century: leaded windows are used in commercial and luxurious residences¹;
- 18th century: wooden frames for domestic buildings, wrought iron frames for industrial buildings (which provided better fire-resistance);
- 1856: hot rolled steel allowed mild steel window frames to be produced (cheaper than wrought iron);
- late 19th century: the steel frame became strong, slim, cheap and could open wider than wooden frames; glazing technology made production of larger glass panes possible;
- early 20th century: non-ferrous metals (e.g. bronze, brass, aluminium) became more common for window frames;
- after 1950: galvanized steel window frames were used to prevent corrosion: molten zinc dip forms a molecular bond with the steel. Aluminium and PVC became widely used for window frames; double-glazed panes and insulation glass units became standard glazing;
- 1970s: use of polyester powder coating as decorative finish, applied on top of galvanisation; late 1970s: thermal separation of steel, aluminium and PVC's frames was introduced to reduce thermal bridges and heat losses.

¹ Picture and rose windows, stained glass windows and Dalle de verre are not discussed here, since there are many specific publications about them available (e.g. Pender and Godfraid, 2011 and RCE, 2004).

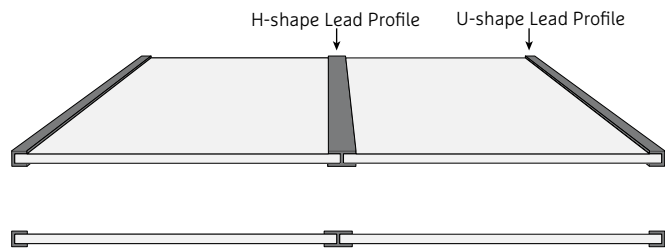

FIG. 5.15 Schematic section of leaded windows with U- and H-shaped lead profiles

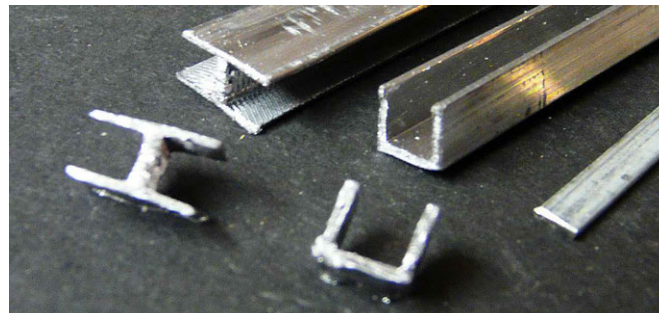

FIG. 5.16 U- and H-shaped lead profiles / Photo: <https://commons.wikimedia.org/wiki/File:Blei.jpg>, accessed Aug. 2021



FIG. 5.17 Wooden window with muntins (glazing bars) connecting small glass panes / Photo: RCE



FIG. 5.18 Puttyed glass in wooden windowframe (in need of repair) / Photo: W. J. Quist

Until the 17th century, glazed windows were directly attached as a fixed glazing to the wall opening. Thus, they were separated from the smaller movable ventilation part made of wood (shutters), metal, leather or textiles. It was only in the 15th-16th century, that the entire wall opening - with jambs, windows and framing decorations - became a central, facade-structuring building element.

Leaded windows (leaded lights or leadlights): were used until the 15th century and constructed by connecting smaller individual glass pieces by using U- and H-shaped lead bars rods or profiles to form a glass pane [FIGS. 5.15/5.16]. The lead profiles were connected with a soldering agent consisting of lead (40%) and tin (60%), called 'glazier's lead'. Putty was used to make the windows waterproof and more stable. Larger window areas were often stabilised with so-called wind irons, to distribute the wind loads into the frame or wall construction.

Muntins or glazing bars: were used to join the smaller glass panes to form a window [FIG. 5.17]. The fine wooden (or metal) bars were grooved on both sides to hold the glass pane and were inserted into each other without glue. The thicker frame pieces were grooved on one side and connected with the bars. Wooden connections were used at the frame corner joints. Thus, window frames were not inherently stiff and the system had the disadvantage that broken glass panes could only be replaced if the window was disassembled. This type of glazing, already used in England, was introduced in the Netherlands and continental Europe at the end of the 17th century and continued to be used to combine small sized glass panes until the middle of the 19th century.

Putty glazing: was used to fix the glass panes against the muntins or glazing bars [FIG. 5.18]. Those had rebates on the outside which were treated with linseed oil varnish before the panes were placed and secured with glazing triangles and then sealed with putty. The linseed oil putty used as window putty is a pliable, kneadable mass with a high plasticity and is still commercially available. It consists of about 85 % slurry chalk (calcium carbonate) and 15 % linseed oil or linseed oil varnish. More recent linseed oil putties from the 1960s and 1970s may contain asbestos fibres. Putties have been used since the late 17th or early 18th century, but they only became widespread in the course of the 19th century. Similar to wood putty, it can be used to repair damaged areas on wooden components.

Wooden sash windows: became popular and spread in the 17th century. The combination of blind frames with movable sash frames represented the first reasonably wind and watertight window construction (Wohlleben and Moeri, 2014). Early wood sash windows were marked by thick muntins and small panes, or lights, due to the high price of glass.

As glass technology improved and prices decreased, lights became larger and muntins became thinner.

Next steps of development were double-wing pivot windows with overlap and the improvement of fittings technology, weather legs and protection and secondary front windows to improve the insulation in winter. Later, single glazed box windows were developed and used because of their good thermal insulation and windproofness. The technical improvements in glass production during the second half of the 19th century led to the enlargement of glass surfaces and thus to the reduction of the number of muntins and finally resulted in the composite window (double-glazed window) - to overcome the disadvantages of the box window, which included condensation in the cavity space and the effort required to manufacture two windows connected by a wooden box (Wohlleben and Moeri, 2014). Wooden frames were common in residential and public architecture until the mid 20th century [FIG. 5.19].

Basic constructions of window types are [FIG. 5.20]:

- single glazed window (consisting of one window sash) and single window with attached glass pane;
- double window (two window sashes mounted one behind the other);
- compound window (two window sashes mounted on top of each other);
- box window (two window sashes connected by a wooden box).



FIG. 5.19 Wooden frames were the most common material for residential buildings until mid 20th century. From early 20th century onwards larger glass panes were used in residential architecture / Photo: pxhere.com

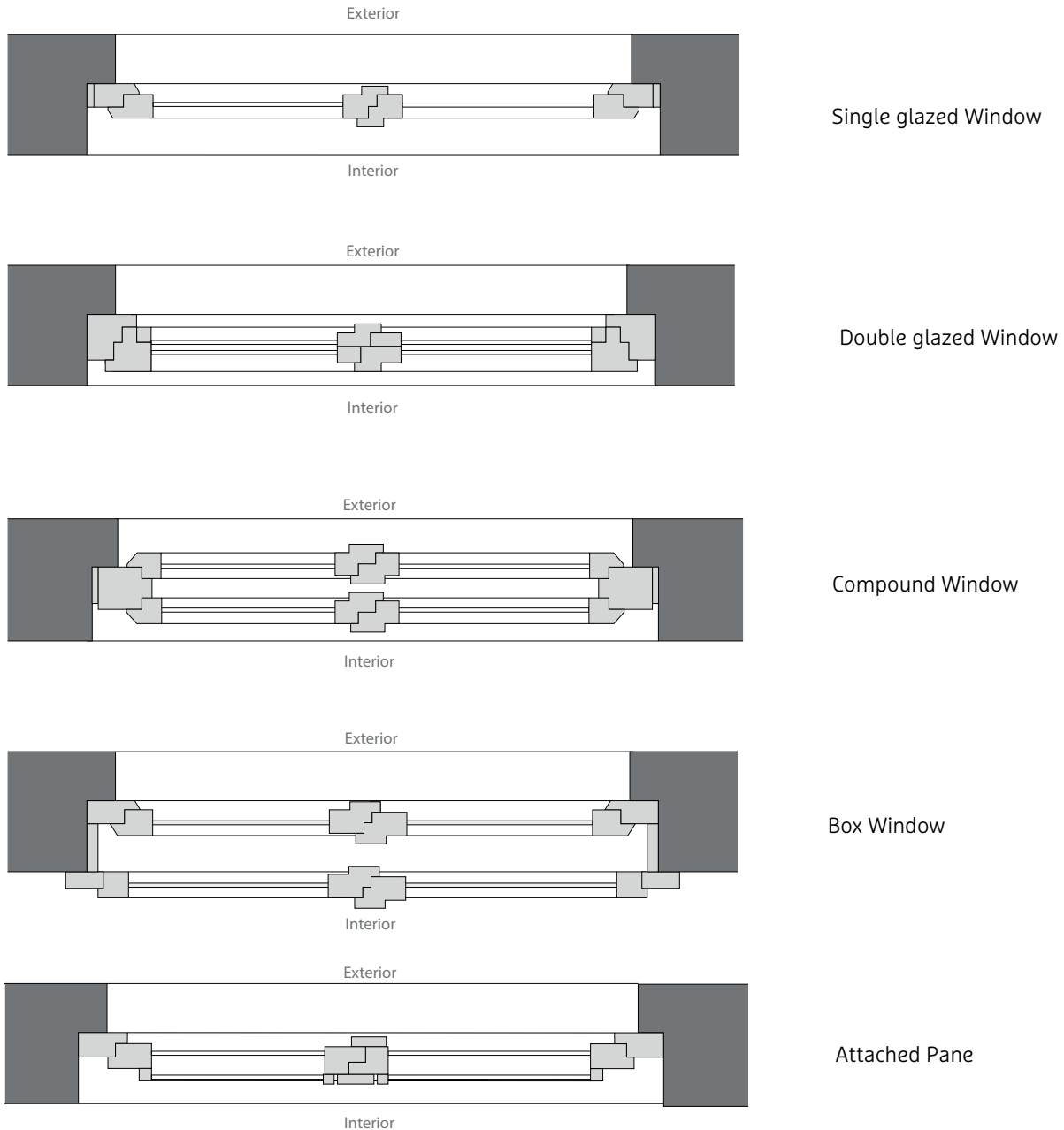

FIG. 5.20 Basic single and double glazed wood window constructions



FIG. 5.21 Metal framed windows were used in industrial architecture since 18th century, and became standard in 20th century with mostly patterned or wired glass, Zollverein Coalmine, 1932 / Photo: U. Pottgiesser



FIG. 5.22 Large metal framed windows were introduced to residential architecture in early 20th century, and became famous with buildings like the Farnsworth House, 1951 / Photo: A. Ayón

Hinges: the Gothic and Renaissance periods were dominated by long, angular and lappet hinges (fixed with a metal plate on the frame) for fixing windows. Sash locks short sliding or locking latches were used for window fastening and for locking (sash windows were in use from the end of the 17th century in the Netherlands). As an innovation, the Baroque era brought the often richly shaped and chiselled chased S-bands, also called spiral bands, which differ only in form from the older lappet hinges. The Baroque period also saw the appearance of fish bands. Fish hinges lobes are embedded or driven into the wood. They are still used today. New, more convenient and better closing window locks (bar locks) were also introduced in the Baroque period.

Metal frames out of wrought iron and later steel were commonly used until mid-20th century in industrial architecture. From early 20th century onwards, metal frames were also used in commercial and residential architecture. For industrial purposes patterned glass was often used since it was cheap, industrially produced and translucent, which provided a good and more homogeneous light distribution compared to transparent glazings [FIG. 5.21]. After 1920 the architecture of the Modern Movement promoted new large-scale glazed surfaces [FIG. 5.22]. The increasing use of industrial and thinner steel frames for administrative and residential buildings allowed for larger glass surfaces to further fuse exterior and interior spaces. Historic profile systems are documented in old construction manuals (e.g. Mittag, 1957) and publications on general construction materials (e.g. Jester, 1995).

After 1950 post-war modernism introduced new types of window openings, such as the pivoting sash. Steel frames were mostly replaced by aluminum frames after 1960. With better heat and noise protection, insulation glass units (IGU) replaced earlier glazing and window types. Frames became thicker again to be able to accommodate the IGU. In the residential sector, Unplasticized Polyvinyl Chloride (uPVC) windows started to dominate the market after the 1970s and led to the replacement and loss of many wooden windows.

Until the middle of the 20th century, residential building's window frames were usually made of wood. In central Europe the share of single glazing in existing windows is supposed to be very low: in Germany it is estimated 2%; the number of box windows is about 70 Mio. and that of compound windows about 40 Mio. (Klos, 2011). The majority of existing windows today is equipped with insulation glass units (IGU) of different ages; however only a few of them form part of listed buildings.

By 2020 the share of the various frame materials in the residential market in Western Europe has remained constant for several years: uPVC is at 58 %, aluminium remains unchanged at 22 %, wood only reaches 17 % and the combination wood-aluminium is 3 %. The share of frame materials in the total window market in Western Europe shows percentages of metal at 36,8 %, PVC at 29,4 %, wood-aluminium at 15,3 %, wood at 14,0 % and uPVC-aluminium frames is at 4,6 % (IC, 2019) [TABLE 5.1].

TABLE 5.1 Comparison of current window materials and their properties (compiled from Cremers 2016 Wikipedia, 2021 and Hildebrandt and Arzmann, 2013).

MATERIAL FRAME / GLAZING	THERMAL RESISTANCE	DURABILITY LIFE SPAN	EFFORT MAINTENANCE	COST INVESTMENT	RECYCLABILITY FRAME
Hardwood	very good	40–100 years	Low/medium ****	medium	high
Softwood	very good	30–50 years			
Steel zincd *	low	40–50 years	very low	high	typically > 85%
Steel zincd **	very good				high > 98%
Aluminium *	low	40–60 year	very low	low	typically > 65%
Aluminium **	very good				typically > 95%
uPVC (“vinyl”)*	very good	25–50 year	very low	low	medium typically > 80%
Fiberglass	very good	40–60 year	very low	high	medium
Composites ***	very good	30–50 years	very low	high	medium
Single glazing	low	60–100 years		low	high
Double glazing	very good	20–30 years	medium	high	medium/low
Putty	medium	8–15 years	high	low	very low
Seal profile	medium	15–25 years	medium	low	low
Sealant (silicone)	medium	10–25 years	medium	low	very low
Sash seal profile	medium	15–25 years	medium	low	low

* thermally separated, ** not thermally separated, ***Aluminium-Wood/uPVC, ****regular maintenance can increase life span significantly

Value and Damage Assessment

‘Surviving historic fenestration is an irreplaceable resource which should be conserved and repaired whenever possible.’ (Pickles et al., 2017, p.3)

The significance of windows and their contribution to the overall significance of a building can be defined through value assessment. This is the key first step in deciding the right course of action when dealing with historic windows [FIG. 5.23]. Significance can be derived from the assessed heritage values. Myers (1981) defines the following five steps for the assessment of wooden windows:

- 1 are original,
- 2 reflect the original design intent for the building,
- 3 reflect period or regional styles or building practices,
- 4 reflect changes to the building resulting from major periods or events, or
- 5 are examples of exceptional craftsmanship or design.

VDL (2017, p.8) states that if windows are ‘important parts of architectural monuments and bear historical or design information’ they are most likely to be ‘constituent parts of the monuments’ [TABLE 5.2].

The value assessment is followed by the damage assessment of existing windows and glazing [TABLE 5.3] which makes use of different methodologies: visual inspection, measurements, documentation, analysis of materials and components.

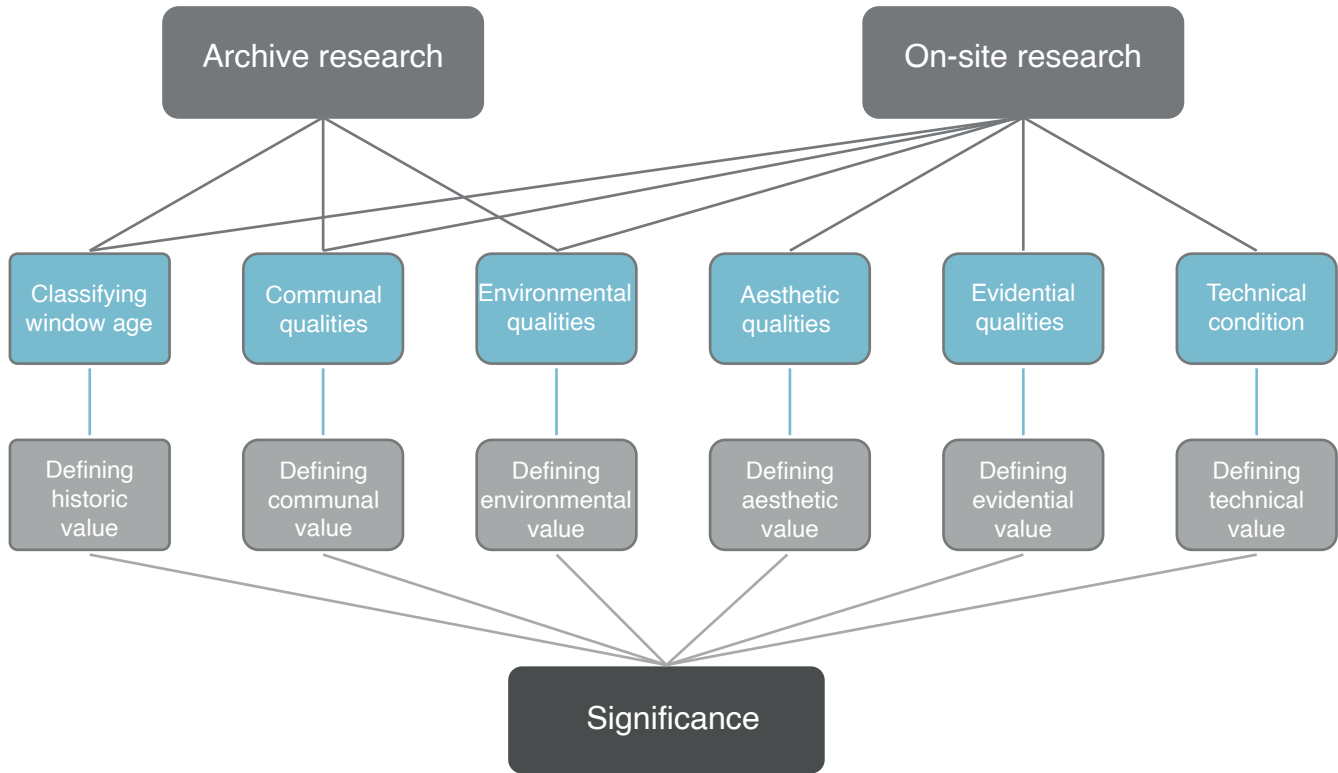

FIG. 5.23 A systematic significance assessment of historic windows includes archival and on-site research, the building context and all window components: frame, fittings, glazing, colour layers, shutters

TABLE 5.2 Assessment of Heritage Values of windows*

HERITAGE VALUES	HOW TO EVALUATE THE DIFFERENT HERITAGE VALUES OF WINDOWS?
Historic value	historic windows document the design, technical and craftsmanship possibilities of their respective time of origin; glass quality improved from blown to drawn and from drawn glass to float glass and historical glazing also documents time of origin; the older the glass is, the more clearly irregularities are visible and perceptible and characteristic: a shop window in a domestic building, for example, may carry considerable historic value indicating the development of the function of the building.
Communal value	may sometimes be found in public buildings and places of worship, this value may not be affected by changes to windows unless they contain commemorative glazing.
Environmental value	window construction represents a typical climate-adapted and localized solution, original windows are material resources (embedded energy).
Aesthetic value	the fenestration often forms an integral part of the design of the building and contributes to a building's visual interest, if later in date, the aesthetic qualities of fenestration may add to or detract from the interest of a building, replicas or recreations of fenestration of aesthetic quality will maintain this value, in contrast, much off-the-peg joinery and modern glazing do not replicate historic appearance and so can detract from the aesthetic value of the building, irregularities such as colour nuances, varying glass thicknesses, warping, inclusions and streaks give the glass its characteristic (aesthetic) appearance.
Evidential value	reflects the potential of a window to yield information about the past rarity adds to the evidential value, an old fabric will probably have a considerable evidential value, a replaced modern standard window will have no evidential value.
Technical value	construction, material and craftsmanship can be significant expressions of certain technological developments, windows may be part of an overall building service system (e.g. ventilation).

* compiled from VDL, 2017, p. 9, and Pickles et al., 2017, p.4

TABLE 5.3 A systematic damage assessment of historic windows and their components*

Wood frames and sash constructions	Warping of frame construction due to poor wood selection or strong temperature and material humidity differences Shrinkage and cracking of the wood Surface weathering (brown/black discoloration of unpainted wood) Wood destroying fungi and insects Mechanical damage (local cavities and dents in the longitudinal direction of the wood, loosening of parts of the wood)
Metal frames and sash constructions	Corrosion of metal framing or signs of rusting Distortion of the frame Mechanical damage Casements that do not move properly, or at all, due to an excessive build-up of paint, rust or distortion of the frame
Paints and Coatings	Embrittlement, cracks, wrinkles, spalling in paint coatings Blisters under and detachment of paint film Leaching or chalking of the colour pigment, in particular oil-based paints Jamming of rotating beam due to ink packs or drip noses in the folds, in the rabbets or in the moving part
Glass and Glazings	Glass breakage and scratches Glass corrosion resulting in opaque surfaces Embrittlement or breakout of the mastic
Fittings and Hinges	Corrosion and material fatigue leading to failed hinges and fittings Deformation resulting in malfunction Insufficient contact pressure or jamming closure
Panels and Spandrels	No or insufficient insulation, mechanical damage or condensation resulting in humidity within the insulation Corroded or insufficient joints and fixings
Wall-Window Connection	Pointing between the frame and the wall opening is cracked, loose, or missing, allowing moisture and draughts to penetrate around the window frame.

* compiled from VDL, 2017, p.11-12

Following the both value and damage assessments, windows can be categorized in terms of their heritage value and damages. VDL (2017, p.9) distinguishes four main categories with regard to interventions:

- A windows from the original building period or from major periods and events of the building - should be maintained,
- B windows without any contribution to the value of the monument/building, which do not lead to structural damage or diminish the value of the monument/building - may be kept or removed,
- C windows that are disturbing or diminishing the value of the monument/building - should be modified/ removed or replaced,
- D windows which, due to their technical design and/or structural-physical performance cause substantial damage to adjoining building components of the monument/building - should be modified/removed or replaced.

5.3 – Intervention Principles and Categories

The relevance of maintenance, repair and careful upgrading of windows is continuously emphasized by heritage experts and authorities. These interventions do not only allow windows to remain serviceable for years, they also allow them to achieve comparable performance results and a better return on invest compared to replacement windows (Pickles et al., 2017; NTHP, 2012; VDL, 2017). Despite all the efforts of heritage and conservation experts, and against the knowledge of practising architects, the replacement of historic windows by new ones is very common. In some European countries, uPVC windows have a high market share. Heritage authorities consider this as the result of marketing campaigns that have persuaded private home-owners that their old timber windows are rotten, draughty and beyond economic repair (Pickles et al., 2017) and that uPVC windows have lower investment costs compared to wooden or even steel windows. However, compared to plastic windows, wooden windows are characterized by their durability and better maintenance and repair capabilities.

With reference to historic architectural glass Pender and Godfraind (2011, p.431) state that ‘few (glasses) are still made, so repair often means reusing salvaged materials’. But usually this results in replacement of the glass itself with new functional glass panes.

The choice of window interventions should pursue the goals of architectural conservation in combination with safety and security concerns, increased energy efficiency, economical and user-friendly solutions. Future use and required functionalities—including energy and sustainability requirements—have to be taken into account:

- *Materials decay*: is a result of deterioration often accelerated by lacking or reduced maintenance.
- *Safety and security*: safety and security requirements have significantly changed over time and buildings and components mostly need to be adapted when the lives and health of users are at risk.
- *Energy efficiency*: energy performance requirements have significantly changed in the recent decades and the energetic improvement of the building stock is a major priority in Europe and worldwide.
- *Indoor environmental quality*: user’s comfort is a crucial factor in further using buildings.

Taking all aspects into account, the building must be considered and treated as a unit, not as a conglomerate of independent components. Only by understanding how the whole building works can renovation mistakes be avoided (Wohlleben and Moeri, 2017).

Overview of Interventions

The following main intervention categories are defined and used:

- *Maintenance*: includes regular measures to preserve the visual and essential functional properties, e.g. cleaning and painting. All measures must ensure that no mechanical or constructional damage occurs to the component.
- *Restoration*: when smaller damages to the frame or glazing occur, it may be necessary to carry out restoration works, which are limited interventions that allow for the selective replication of missing or severely deteriorated components. Interventions must be preceded by an exact documentation inventory in order to enable the detailed planning of measures.
- *Rehabilitation/Retrofit*: when construction-related defects lead to increased wear and repeated damage, the constructions have to be adapted and improved to such an extent that damage is avoided and the time between repair actions is extended. Rehabilitation work is often implemented when new requirements apply or functioning needs to be improved or the original glass panes have been lost, and are no longer commercially available, or where it is not financially feasible or desirable to replicate them. Interventions also depend on the thickness and state of the frame. The tried and tested technical possibilities for improving the function of windows, i.e. above all for improving energy efficiency and sound insulation, are many and varied—but they lead to more or less severe changes in the substance and/or appearance.
- *Replacement*: intervention when, despite the significance of the windows, the original frames and glazing cannot be kept and need substitution. When the windows are replaced for a functional improvement, the building fabric is irretrievably lost.

TABLE 5.4 shows the principles and measures for improving the qualities of a window.

TABLE 5.4 General Intervention categories for window constructions and glazings*

PRINCIPLES	MEASURES	DESCRIPTION
Maintenance	Cleaning	Removal of dirt, biological growth to keep surface in function.
	Painting	Wooden and steel frames need regularly repainting.
	Regrouting putty	Putty joints must be checked regularly for completeness and supplemented or replaced if necessary.
Restoration	Weather stripping or draught proofing (carpentry overhaul)	Improving the airtightness of an existing window by sealing gaps at head, sill, meeting rail, and at vertical edges to reduce air leakage. Common types are: spring-metal, plastic strips, compressible foam tapes, and sealant beads.
	Surface-mounted film	Improving the impact safety of the glass and enhancing visible light protection and/or interior UV protection, sun and glare control; retaining the original glazing, although thin films lead to visual impact through small overlaps and joints.
	In-kind glazing	Replacement with a new single glazing with similar visual appearance and thermal performance as the original glazing.
	Laminated glazing	Replacement with a new laminated single glazing within the metal frame to improve the impact safety and/or interior UV protection; visual appearance depends on glass selection.
	In-kind thermally non-separated frames	Replacement with a new frames with similar visual appearance and thermal performance as the original frame.
Rehabilitation or Retrofit	Coated glazing	Replacement with a new coated single glazing to improve the thermal performance; the visual appearance depends on glass selection.
	Secondary glazing (Interior window)	Additional frame applied to the inside of an existing frame to achieve higher levels of thermal and sound insulation without compromising the outer appearance of the building.
	Secondary glazing (exterior window)	Additional frame applied to the outside of an existing window to protect from weather and to improve energy performance without compromising the inner appearance of the building
	Insulating shades, curtains or shutters	Additional shading element applied to the inside (shades, curtains) or outside (shutter) of the window which also improves the thermal insulation.
	New insulation glazing	Replacement with a new double insulating glazing with different visual appearance and better thermal performance than the original glazing; can often be mounted in the original frame; due to its thickness, triple glazing is normally not used.
	New vacuum glazing	Replacement with a new vacuum glazing with similar visual appearance and better thermal performance than the original glazing; can often be mounted in the original frame.
	Combination of several measures	There are many combinations of preservation and rehabilitation measures which can be applied to wooden as well as metal windows.
Replacement	New, high performance replacement window not visually distinguishable	Replacement with new, high-performance window to improve thermal performance and airtightness - visually adapted.
	New, high performance replacement window visually distinguishable	Replacement with new, high performance window to improve thermal performance and airtightness - visually different.

* compiled from Ayón et al. 2019; NTHP, 2012; Pickles et al., 2017; Kantonale, 2014 and TU Delft, University course CSI, 2021.

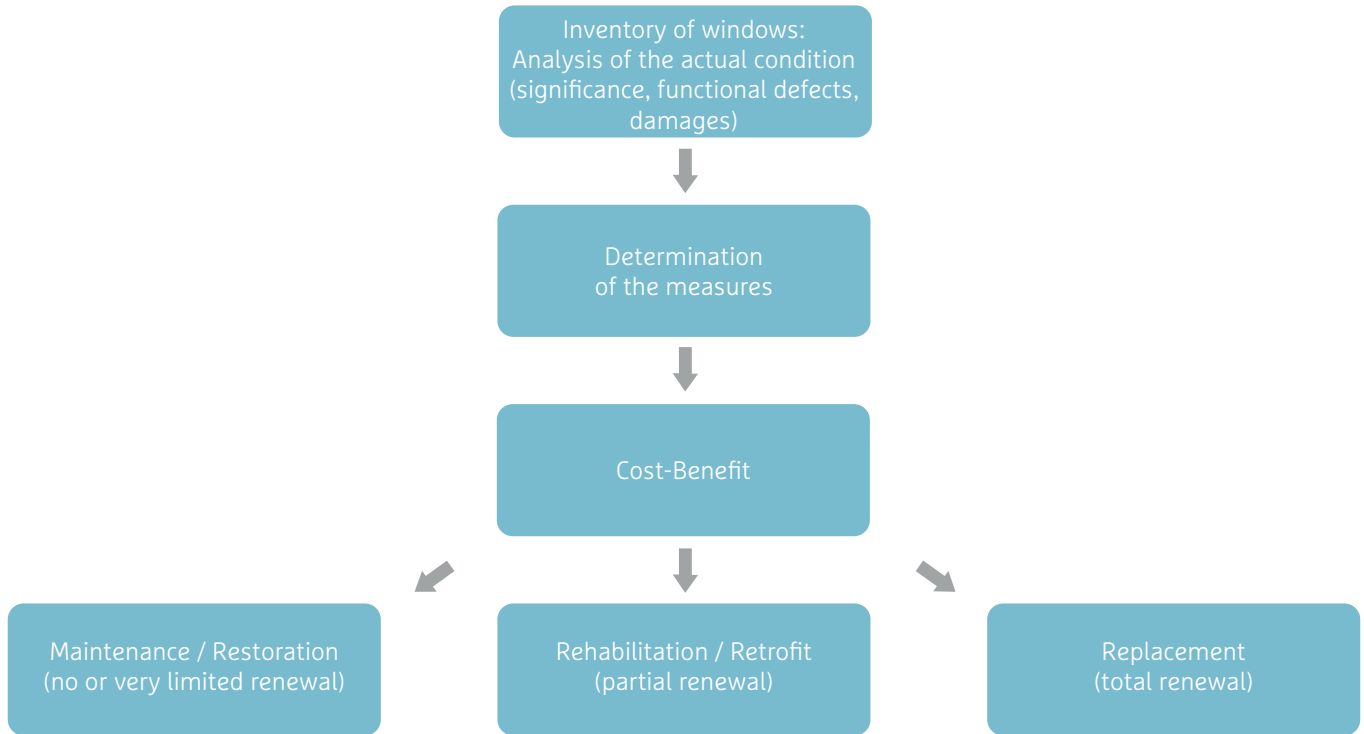

FIG. 5.24 Decision making between intervention categories for a single window

Depending on construction, condition, existing requirements (e.g. monument protection) and desired improvements (e.g. airtightness, thermal insulation, sound insulation), the decision results for maintenance, restoration, rehabilitation/retrofit (partial renewal) or replacement (total renewal) are shown in [FIG. 5.24] in a flowchart. Decisions are made per window. Categories can also be combined in one building depending on the value and damage assessment.

Temporary Interventions

Temporary measures such as curtains or shutters can significantly improve the thermal comfort of a window. In principle, they reduce heat loss. The thermal insulation of windows is verified using the U_w value in $W/(m^2 K)$ and U_g value in $W/(m^2 K)$. The U-value denotes the heat transfer coefficient of a building component (Unit of heat transfer). In the case of windows, the index w stands for 'window', the index g for 'glass'.

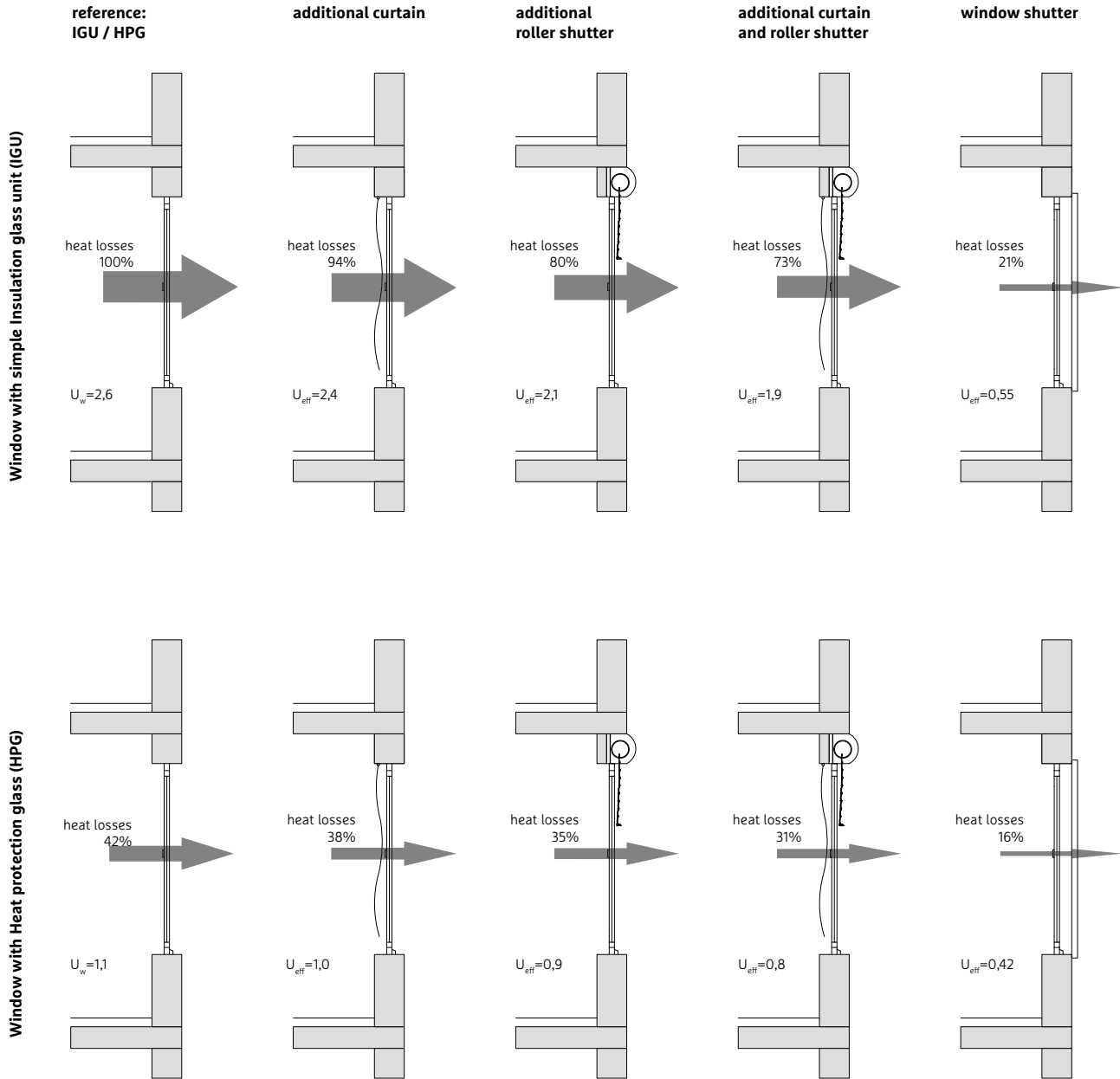

FIG. 5.25 Insulating shades, curtains or shutters are reducing heat loss (indicated in %) and improve the thermal performance of windows (according to Wohlleben and Moeri, 2014, p.34 and Cremers, 2016, p.58).



FIG. 5.26 Window with a historic irregular glass surface left and a new flat float glass surface right / Photo: H. v.d. Ven

In FIG. 5.25 the U_{eff} -value considers the reduction of heat loss by measures such as curtains or shutters. The index eff stands for 'effective'. The figure shows the original U_w -value in $\text{W}/(\text{m}^2 \text{K})$, its reduction with the U_{eff} -value in $\text{W}/(\text{m}^2 \text{K})$ and the heat demand in percentage. However, the curtains must be long enough (ideally extending over the windowsill) and the shutters must be installed without thermal bridges. If they are partially transparent or translucent, they also serve as sun protection, depending on the total energy transmittance value. In principle, these interventions are suitable for wood and steel windows.

Baker (2017, p.18) indicates 'that whilst low-e secondary glazing has the greater impact on reducing heat loss through

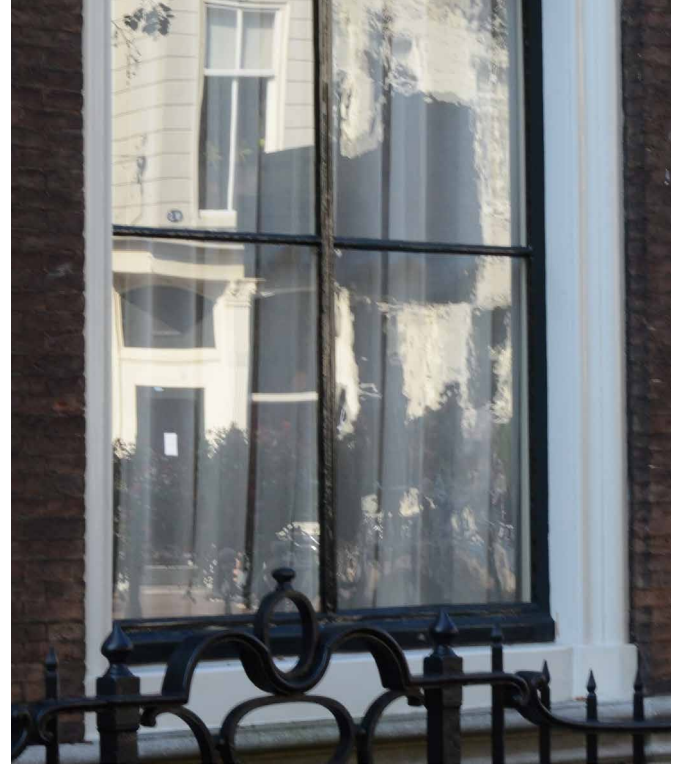

FIG. 5.27 Historic window with float glass panels (lower left) / Photo: W.J. Quist

the whole window (68% reduction in heat loss), curtains are also an effective option'. In addition, curtains also reduce the heat loss through the frame effectively.

Interventions to glazings

Today it is common to replace historical glass with float glass. The use of float glass as replacement for original drawn or plate glass may require some compromises to be adopted. Aside from the visual differences between the products, there are limitations to the sizes available for today's float glass sheets which may pose additional challenges for reglazing interventions at modern buildings that require large sizes (Ayón, 2019) [FIGS. 5.26/5.27].

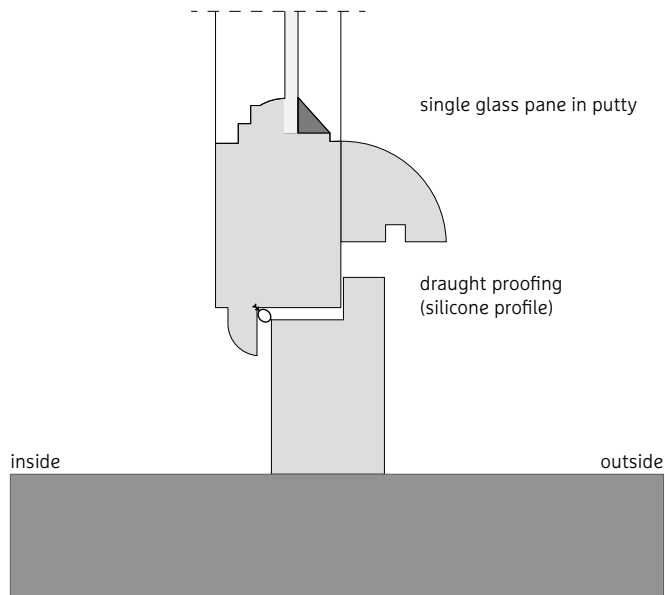

FIG. 5.28 Sash frame with new sealing: a) Image and b) schematic drawing / Photo: S. Rexroth

New developments in glazing technology and the need to increase energy efficiency of buildings resulted in thicker triple-glazing elements, which are seen as being critical due to their weight and their need for thicker frames. Thin vacuum glazing has the advantage of having less weight and of better fitting into historic frames. It is not yet widely available on the market and therefore quite expensive.

Interventions to wooden windows

A common and less invasive measure for restoring und slightly upgrading wooden windows is first of all a carpentry overhaul that can be applied to single, composite or box windows. The windows are entirely closable and serviceable and a silicone tube profile seals the window sash (or in the inner window sash in case of compound and box windows) against draughts. This reduces ventilation heat losses. Draught leaks are usually caused by warped sash frames of which the

rebates no longer close evenly. To remedy this, they should first be reworked by craftsmen. Gaping irregularities can be closed flexibly by installing concealed crimp seals in the frame rebate of the sash frame, which also improves sound insulation [FIG. 5.28]. It is important that the seal is loose enough to close the existing gaps on the one hand, and on the other hand that the closing function is not impaired, e.g. by bulging. It should be recognized, however, that the improvement in tightness and heat loss reduction may be accompanied by a reduction in the hygienically required air exchange.

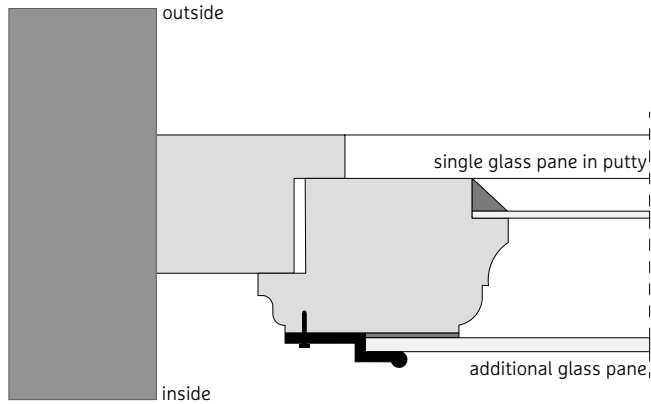

FIG. 5.29 Single glazed wooden window with a frameless additional pane fixed with clips

Single windows can be converted into compound windows by attaching additional panes. The additional sashes, equipped with seals and possibly coated glass, are mounted on the existing window frame. If it is frameless, the additional sash, equipped with seals, is pressed to the existing window frame by means of sash locks or clips. Another possibility is to mount an additional framed pane adapted to the existing window. Usually, the frameless or framed panes are mounted on the inner sash frame. This creates a composite system for each sash. The new sash is only opened for (infrequent) cleaning purposes [FIGS. 5.29/5.30]. The advantage of this measure is the relatively low interference with the substance, but can however result in reduced transmission and an additional load that the existing frame has to bear. The U-value of the window is reduced to around 40 % (approx. $2.1 \text{ W}/(\text{m}^2 \text{ K})$) with a pyrolytic coated pane (assumption: usual frame share with a U-value of 2.0 to $2.4 \text{ W}/(\text{m}^2 \text{ K})$).

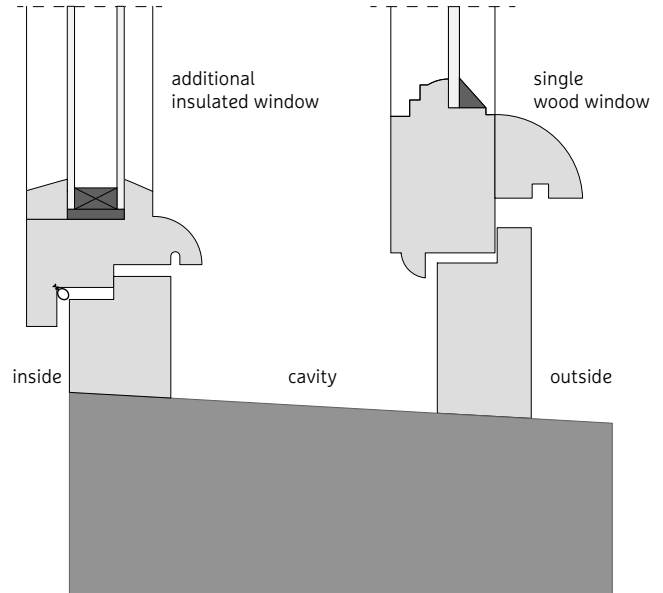

FIG. 5.30 Single wood window converted in a double window with an additional insulated window at the inside (cavity)

Adding a second, insulated glazed window to the outside or inside of the single window turns the single window into a double window [FIG. 5.31]. The original window (usually on the outside) remains unchanged and is supplemented by a recessed interior window that can be installed either in the reveal or on the interior wall. The wide layer of air between the two window levels improves significantly heat and sound insulation. In principle, this intervention is suitable for wood and steel windows.

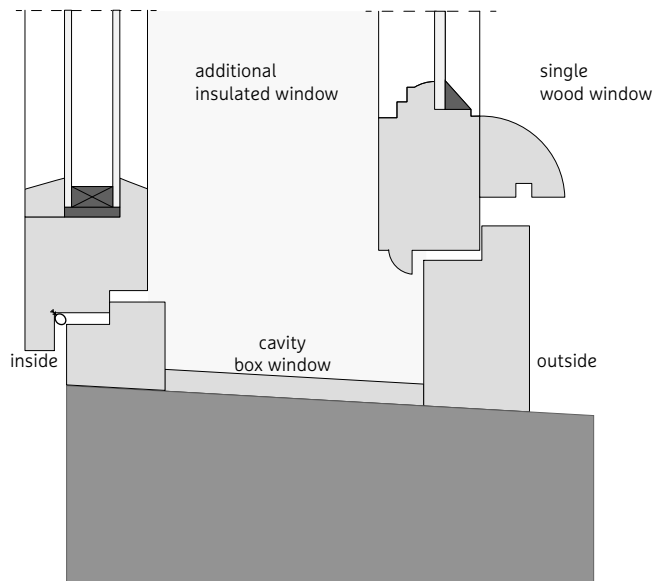

FIG. 5.31 Single wood window converted in a double window with an additional insulated window at the inside (box)

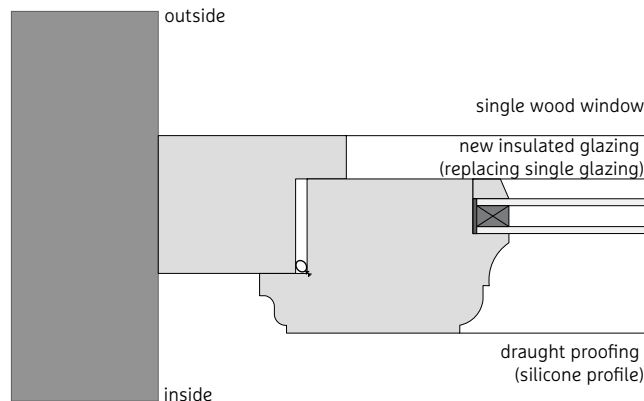

FIG. 5.32 Single wood window frame with inserted profile seals and new glazing, here: double insulation glass

If the frame profile of a single window is wide enough and has sufficient load-bearing capacity, the single glazing can be replaced with double insulating glazing or (slimmer) vacuum glazing [FIG. 5.32]. Lower heat loss is achieved simply by replacing the single pane with a pyrolytic-coated pane (Low-E-Glass, 'K-glass™'). However, it should be noted that the coating is sensitive to mechanical damage. The U-value of the window is reduced to around 56 % (approx. 2.7 W/(m² K) with a 10 mm insulation glass filled with Argon (assumption: usual frame share with an U-value of 2.0 to 2.4 W/(m² K)).

If new glass panes are installed, special attention must be paid to the glazing bars. They are usually placed on the glass panes as so-called superimposed Viennese bars ('Wiener Sprosse'), a spacer is mounted in the space between the panes [FIG. 5.33].

In the case of compound windows, it is technically possible to replace the glazing in the inner or outer sash with insulating glass panes [FIG. 5.34]. Similarly to single windows, the frame must be appropriately wide and the rebate appropriately deep.

Box Windows: With a window lining between the windows, the double window can be considered as an energetically favourable, historically widespread type of box window. In addition to refurbishing both sashes as in the case of single windows and milling a concealed crimp seal (usually in the frame of the inner sash), the glazing can also be replaced. With an insulated glazed window level the U-value of the window is reduced to around 27 % (approx. 1.3 W/(m² K) with a 20 mm insulation glass unit (IGUs) filled with Argon (assumption: usual frame share with a U-value of 2.0 to 2.4 W/(m² K)).

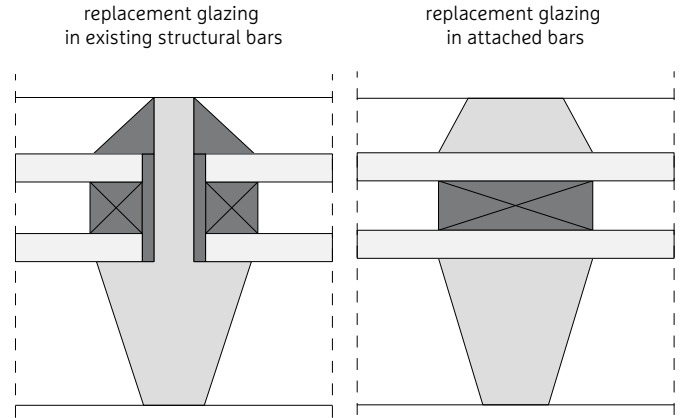

FIG. 5.33 Attached glazing bars are used when the existing structural bars are not wide or deep enough to accommodate double glazing

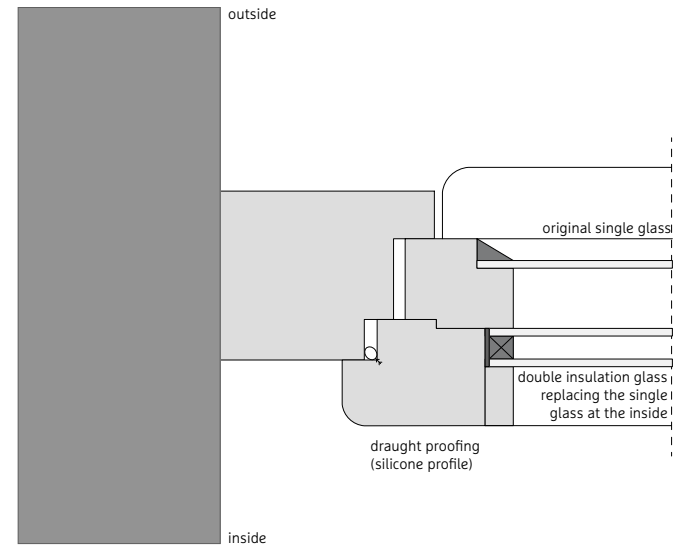
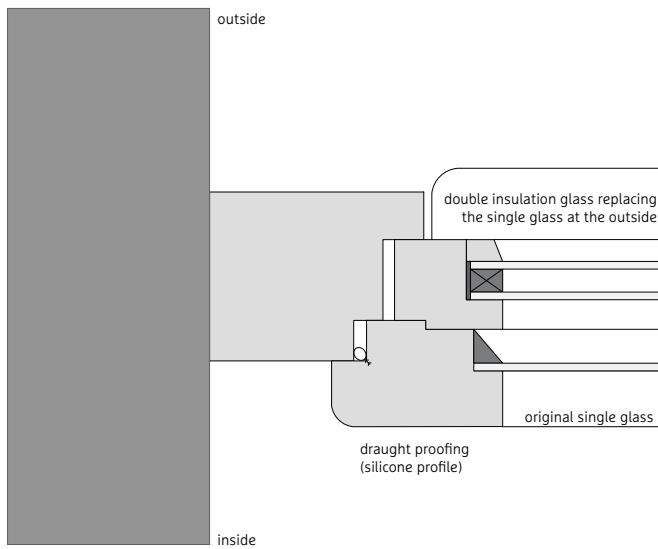

FIG. 5.34 Compound window with a replaced glass pane, left: double insulation glass outside, and right: double insulation glass inside

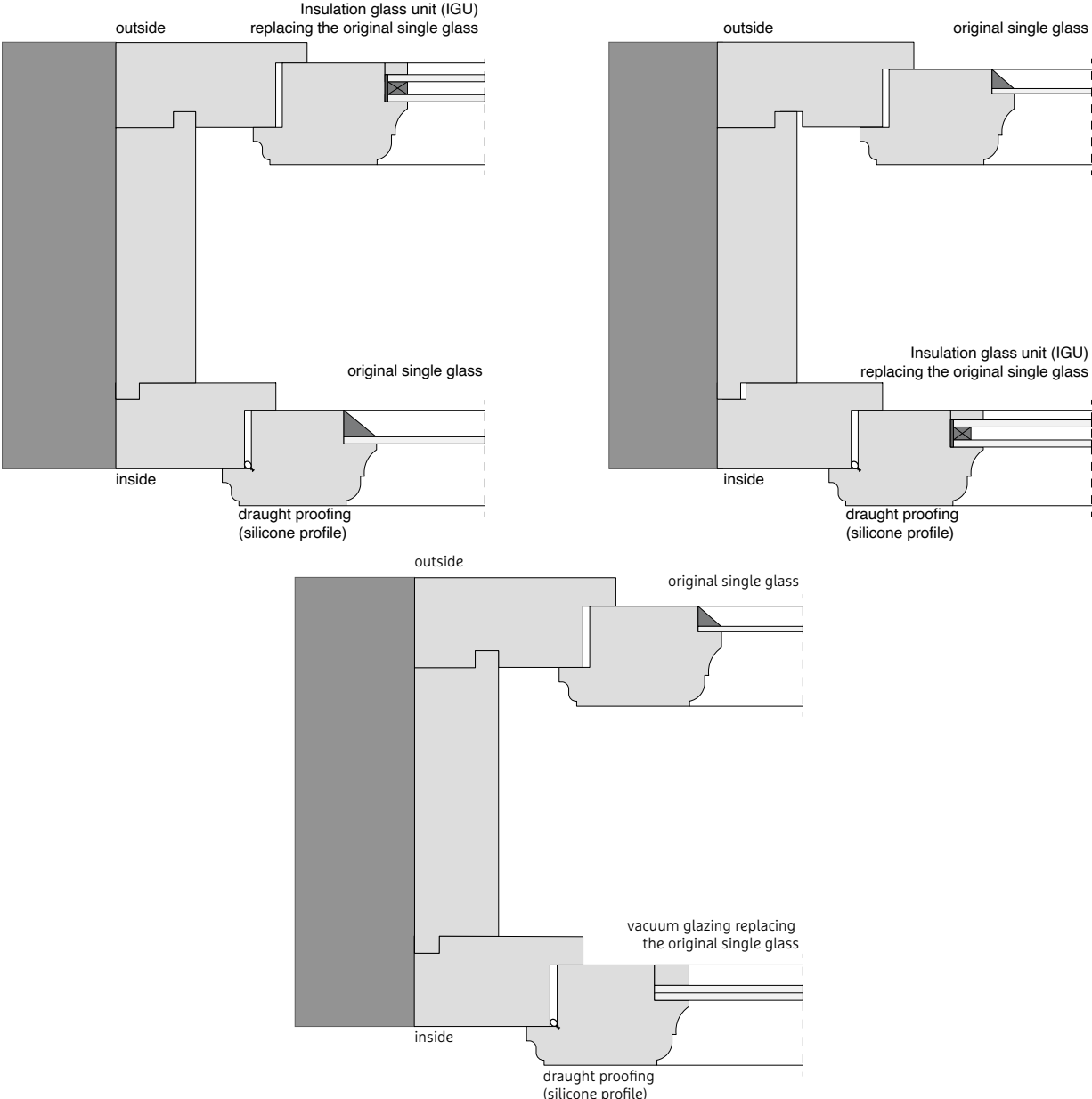

FIG. 5.35 Main intervention categories to improve energy efficiency and comfort of box windows: a) replace with insulating glazing outside, b) replace with insulation glazing inside, and c) replace with vacuum glazing inside

The replacement of the existing glazing should be considered as part of an overall building physics concept: thicker panes improve sound insulation, specially coated glass acts as heat and sun protection, and frosted panes or decorative glass serve as privacy screens. The glass industry offers reduced insulation glass units (IGUs) with a total thickness of 12 mm (3/6/3 mm); special insulating glass is even available with a total thickness starting at 8 mm, vacuum insulating glazing with a total thickness of 6.2 mm (3/0.2/3 mm). If it seems expedient to replace the entire window sash, this is usually done on the inner window to preserve the external appearance [FIG. 5.34]. This measure is also often chosen for reasons of building physics, as the inner sash then seals the box airtight, thus preventing condensation from forming in the space between the windows. The intervention to improve the outer window is a feasible renovation variant if the box window is to be upgraded during operation (e.g. while the building is let), because the inner sash remains functional at all times.

The intervention is demanding in terms of building physics, because the minimum air exchange must not be impeded. In general, the thermal insulation of any energetically retrofitted window must not be better than that of the wall, because otherwise condensation can form, especially in the window reveal, associated with a risk of mould.

(Rexroth et al., 2020) demonstrated that box windows with a carpentry overhaul have the lowest energy consumption compared to the other glazing variants and for different orientations. Measurements proved that the reworked box-type window ranked first towards the south, while the energetically optimized box-type window with double insulating glass in the outer frame ranked first towards north and east. Of course, the results depend on parameters like outside temperatures and solar radiation on the glazing.

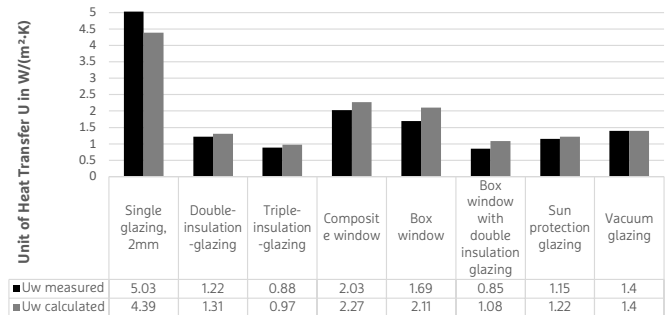

TABLE 5.5 Comparison between measured and calculated U_w -values in the research project 'Fenstervergleich' at HTW Berlin.

Especially the glazing types without coated panes (single glass, laminated and box windows) benefit from the solar irradiation. The study also showed that the calculation of the U_w -value according to the relevant standard (DIN EN ISO 10077-1 | 2020-10 Thermal Performance of Windows, Doors and Shutters - Calculation of Thermal Transmittance) does not represent the achieved values. Tests in the double climate chamber determined better U_w -values shown in Table 5.5.

The results also show that U_w -values mainly depend on the apportioning of wood frame and glazing. The windows in the research project are rather small. A Box window with a 20 mm double insulation glazing in a standard format has a U -value 1.3 $W/(m^2 K)$.

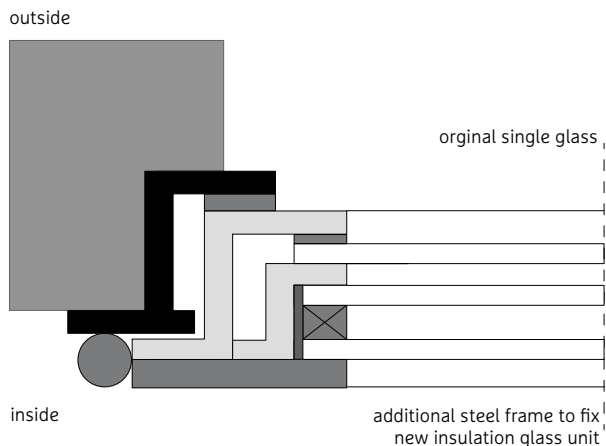

FIG. 5.36 Single glass window converted into compound window

Interventions to Steel Windows

Windows with steel frames have particularly high heat losses due to the high thermal conductivity of material. They are also susceptible to condensation and thus to corrosion. Also, the mostly slim frames - compared to wood frames - make it more difficult to replace the glass and to create a thermal separation. Still, most interventions suitable for wood windows can also be applied to steel windows. A general overview of preservation approaches to modern architecture is available in (Prudon, 2008), more detailed examples can be found in (Ayón et al., 2019, RCE, 2008 and Stazi, 2012).

Single windows can also be converted into compound windows by attaching additional panes, although this is less commonly applied to steel than to wood windows due to the higher risk of thermal bridging [FIG. 5.36]. The additional sashes, equipped with seals and possibly coated glass, are mounted on the existing window frame. Another possibility is to mount an additional framed pane adapted to the existing window.

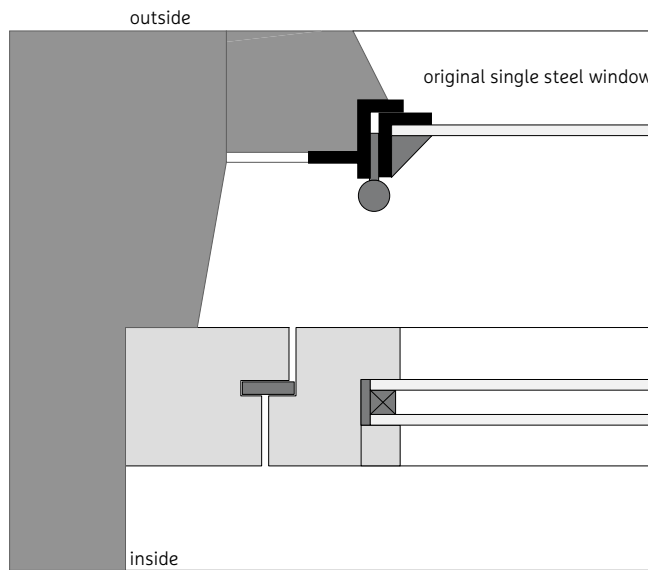

FIG. 5.37 a) Single steel windows with new secondary wood-framed glazing at the interior and b) scheme / Photo: S. Rexroth

Adding a secondary insulated glazed window to the outside or inside of the single window turns the single window into a double window [FIG. 5.37]. With a larger distance between the frames, it can be considered as a type of the energetically favourable and historically widespread box window.

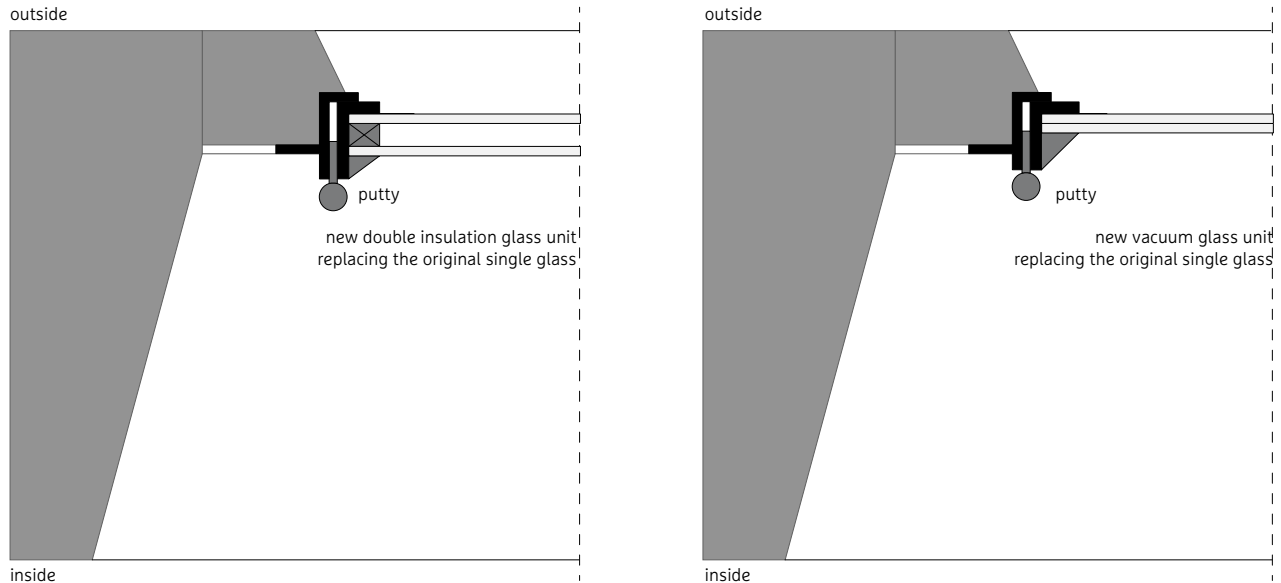

FIG. 5.38 Single steel windows with new double insulation glass, left, and right new vacuum glass unit

The original window (usually on the outside) remains unchanged and is supplemented by a recessed interior window that can be installed either in the reveal or on the interior wall. In the simplest version of this approach, the secondary glazing consists of an additional interior operable inward-swinging sash with single-pane glass located immediately adjacent to the original single-pane sash at the exterior glazed enclosure. When closed, this creates an air-tight cavity between both glazed assemblies while allowing for maintenance and cleaning when required. A more elaborate solution includes the installation of a new insulated interior partition on the inboard side of the exterior walls. The insulated partition includes a new steel (or aluminium or wood) frame assembly in front of the existing exterior openings. The secondary glazing includes an inward-swinging sash with insulation glass units (IGUs) for cleaning and maintenance.

The installation of new IGUs in restored frames usually means that the old putty or glazing beads need to be removed, and new glazing beads designed to accommodate the new glazing are added (FIG. 5.38). Given that an IGU is thicker and heavier than the original single-pane glass, the replacement glazing bead is typically shallow and high-strength in order to be able to retain the IGU in place. Industry standards relating to the required bite size, face and edge clearances must also be considered when designing IGU and glazing bead installations on existing frames. It is advisable to coordinate the location of the replacement IGUs with the interior programs. Instead of implementing a building-wide wholesale glass replacement, consideration should be given to doing so only at strategic locations where the program requires enhanced performance (e.g. offices or residential spaces with permanent occupancy). As an alternative for the IGU thinner vacuum glazing can be used as replacement glazing. Electrical frame heating can be applied to avoid condensation forming on the frames.



FIG. 5.39 New National Gallery, Berlin: original glazing (above) and three variants for the rehabilitation. In order to avoid glass breakage in the future, a double-thick laminated safety glass (2 x 12 mm) was used (second variant from above). The other two variants would have distorted the appearance of the construction too much. / Photo: F. May

Thermally separated steel frames are chosen when thermal losses and energy consumption should be minimized, resulting in optimum environmental performance. Thermal separation can only be achieved through replacement with a new frame construction and at greater expense. This solution is suitable in cases where enhanced environmental performance is desired in addition to retention of the historic appearance. The replacement steel frames for these assemblies can be made of custom hot-rolled components assembled through a proprietary systems (e.g. used studio windows at Bauhaus Dessau, Germany), or tailor-made cold-formed hollow metal works (e.g. at Zeche Zollverein, Germany) or a combination of the two (e.g. Guggenheim Museum, USA).

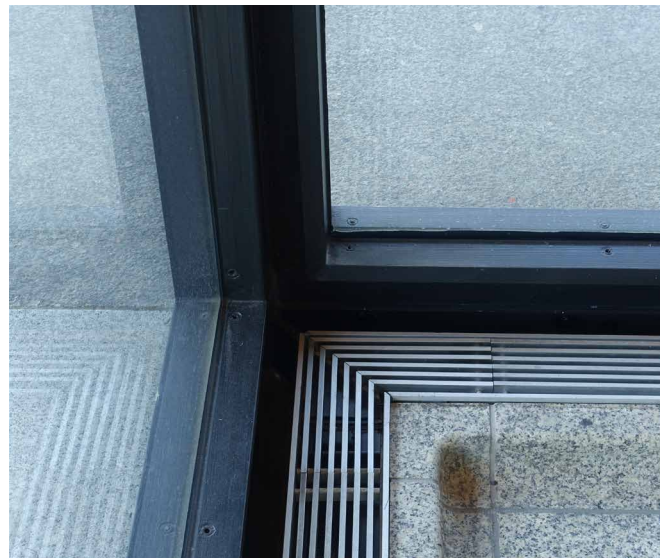

FIG. 5.40 New National Gallery, Berlin: New facade with a single glazing in a thermally non-separated construction / Photo: F. May

A currently prominent example for the handling of such demanding window types is the renovation of the Neue Nationalgalerie (New National Gallery) in Berlin. The facade construction, which was not thermally separated, in conjunction with the relatively high humidity during exhibition operation, led to a high level of condensation from outside temperatures below 4° C. In order to minimize condensation, a detailed feasibility study was carried out at the beginning of the preliminary planning phase to investigate the use of double-glazed insulating glass. After weighing up the arguments relating to the preservation of monuments and technical aspects, David Chipperfield Architects however made the decision in favour of single glazing in a thermally non-separated construction [FIGS. 5.39/5.40], as this was the best way to preserve the appearance of the high-ranking monument (Bauwelt, 2021).

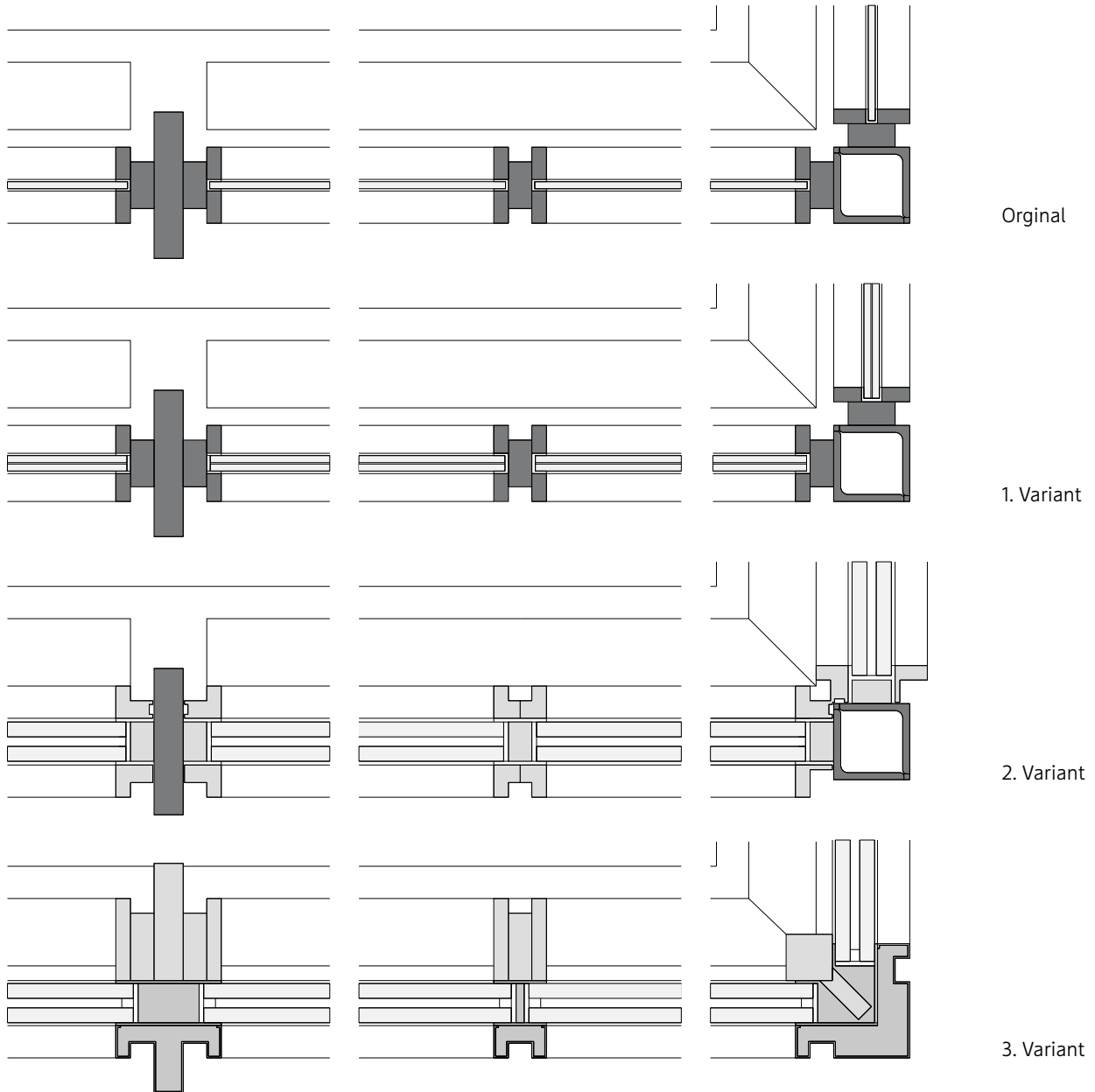

FIG. 5.41 New National Gallery, Berlin: Original facade construction with steel windows and three variants of their rehabilitation. The first variant was used (David Chipperfield Architects, 2021).

The results of several studies have showed that window maintenance and rehabilitation options have the potential to significantly improve the energy efficiency of a building with existing leaky, single-pane, or historic compound and box windows (NTHP, 2012; Rexroth et al., 2020). The particular effects depend substantially on rehabilitation options, energy costs, climate conditions and specific funding or incentives. NTHP (2012, p.50) states that ‘retrofit options fall into the range of expected performance that a replacement window might achieve (specifically exterior and interior storm windows, especially when combined with cellular shades), showing that retrofit options should be a first consideration before replacements’. It is the intention of this publication to shed more light on the common successful strategies and techniques to maintain and conserve existing window construction as significant part of the built heritage.

5.4 – Future research

Studies mentioned above identified a number of future research opportunities that could provide a more comprehensive understanding of window rehabilitation/retrofit and replacement options for older leaky, single-pane windows. These include to understand window rehabilitation as part of holistic building retrofit: in many cases, choosing to retrofit or replace windows may not be the most cost-effective or efficient way to improve the energy performance of an older building. A detailed analysis is needed to evaluate how to prioritize window upgrades in the context of other energy-efficiency measures such as applying wall and roof insulation, whole-house air sealing, and upgrading existing heating and cooling equipment.

Life Cycle Assessment: further research is needed to understand how interventions to windows correlate with impacts to the environment or to human health taking into account material production, transportation, maintenance, replacement, or disposal over the anticipated life span of the windows. Due to the wide range of material choices that exist for window rehabilitation/retrofit or replacement measures, regionally different result might be expected.

Valuation of thermal insulation of existing windows according to normative calculation methods: in detail, the problem is as follows: according to normative calculation procedures, the entire box-type window is evaluated with a default value of 2.5 W/(m² K). According to the normative calculation procedure, the glazing of a box-type window has the same value as a double glazing (without coating), namely between 2.76 and 2.88 W/(m² K). The windows are evaluated under the boundary condition of steady-state conditions. The air layer in the space between the panes is inaccurately taken into account. Therefore, it is necessary to measure and evaluate existing windows under real conditions, in-situ. A critical mass of data and its evaluation can help to adequately assess rehabilitation options of existing windows (Rexroth et al., 2020).

Thermal breaks and coatings: in the fenestration frame industry, additional research and development of thermal break materials is required. Stiffer materials with increased thermal performance are needed, particularly for use in thermally broken steel frame systems which typically have slim and shallow frame profiles that pose a challenge to replacement interventions. Further development of thermal break materials and frame installation systems during the last decade has created some innovative and suitable products. Still, more competition and availability of such systems in the marketplace are needed to overcome increased project costs.

5.5 – Conclusions

Historic windows and glazing need to be preserved as they constitute an integral part of a monumental building. Classifying them in terms of their monumental value requires analysing and evaluating them according to window type, construction and material used. Checklists help to take a differentiated look at the state of preservation of a window. Only after establishing the value of the windows and their components, and their state of preservation, the choice for a suitable intervention can be made, also considering the (new) function of the building.



6 – Conclusions

Conservation of built heritage implies the preservation of values, materials and techniques. Interventions in heritage buildings should be minimal, necessary and compatible in aesthetical and technical sense. The quality of the interventions needs to meet intended and agreed-to standards.

This book underlines the importance of a sound assessment of the values of a historic building and its technical state of conservation before planning an intervention. How indispensable this step is, is shown by selected examples of building materials and relevant parts of historic buildings. Moisture-induced damage processes and solutions to tackle them have been discussed using the examples of rising damp and surface treatment. The considerations on how and when to maintain and conserve a historic material such as natural stone have been reviewed. The importance of an integrated approach to conservation has been explained, focusing on windows and glazing.

Knowledge on specific building materials, building components, damage types and damaging mechanisms as well as methodologies for conservation are presented. The topics have deliberately been chosen to illustrate the wide range of aspects which need to be dealt with in conservation of built heritage. Although discussed from a Western European perspective – as shown by the materials and specific components examined - the aim is to present a valid and broadly applicable approach.

Historic monuments conservation demands a specific, transdisciplinary and holistic approach, which can be visualized as a circular decision-making process instead of a linear one, which would benefit the maintenance of non-monumental buildings too. This includes the involvement of owners and end users. The presented methods and methodologies illustrate the possibilities for such a circular approach in research and decision making, when dealing with cultural historical values and technical design solutions.

This book has been made to not only transfer knowledge, but also to convey an attitude in approaching the manifold aspects of dealing with our valuable built heritage to new generations of architects.

It is expected that digital support tools for survey, monitoring, diagnosis, documentation and decision making will be developed, to further facilitate the architects of the future and other stakeholders handing our heritage over to the next generation.

Heritage preservation is not only a technical but also a socio-cultural challenge.



References

- AIC, *Studies in Conservation*, 1964(9) no. 3, p.116-121.
- Anonymous (1983). 'The World of conservation: an interview with Raymond Lemaire'. *Monumentum*, York 1983(26) no. 2. p.83-100.
- ASTM C1722 – Standard Guide for Repair and Restoration of Dimension Stone.
- ASTM (2017), D3359-17 - Standard Test Methods for Rating Adhesion by Tape Test, ASTM International.
- Athens Charter, 1931 'The Athens Charter for the Restoration of Historic Monuments Adopted at the First International Congress of Architects and Technicians of Historic Monuments', Athens 1931.
- Avrami, E., Mason R., Torre De la, M. (2000). *Values and Heritage Conservation*, Getty Conservation Institute, p.100.
- Ayón, A., Pottgiesser, U. and Richards, N. (2019) *Reglazing Modernism? Intervention Strategies for 20th-Century Icons, Reglazing Modernism*. De Gruyter. doi: 10.1515/9783035619348.
- Baker, P. (2017) *Improving the Thermal Performance of Traditional Windows?: Metal-framed Windows*, Research Report Series no.15. Swindon. Available at: <https://research.historicengland.org.uk/Report.aspx?i=15568>. (Accessed: 1 May 2021).
- Balen van, K. Papayianni, I., Hees van, R. P. J., Binda, L. and Waldum, A. (2005) 'Introduction to requirements for and functions and properties of repair mortars', *Materials and Structures/Materiaux et Constructions*, 38(282), pp.781–785. doi: 10.1617/14319.
- Bauwelt (2021) 'Die Neue Nationalgalerie', 9.2021, 27 April. Available at: <https://www.bauwelt.de/9.2021-3606593.html> (Accessed: 24 May 2021).
- Bommel, A.J. van. (2013). 'Terugblik op een geslaagd project. De restauratie van het Koninklijk Paleis Amsterdam'. In: *Bulletin KNOB* vol 112 nr. 2, p.68-79.
- Borsoi, G., Lubelli B. and Hees van, R. P. J. (2017) 'Evaluation of the effectiveness and compatibility of nanolime consolidants with improved properties', *Construction and Building Materials*. Elsevier Ltd, 142, pp.385–394. doi: 10.1016/j.conbuildmat.2017.03.097.
- Borsoi, G. (2017). *Nanostructured lime-based materials for the conservation of calcareous substrates*. doi: 10.7480/abe.2018.8.
- Brans, E.J. (2012). 'Uitvoeren van constructief herstel – balanceren tussen consolideren en vernieuwen. In: Hunen, M. Van, *Historisch Metselwerk - Instandhouding, herstel en conservering*. WBOOKS & Rijksdienst voor het Cultureel Erfgoed.
- Brimblecombe, P. (2010). 'Mapping heritage climatologies', in Bunnik, T. et al. (eds) *WTA Schrift*. WTA.
- Burra Charter (1999). *The Australia ICOMOS Charter for Places of Cultural Significance* https://www.academia.edu/4668008/Burra_Charter_The_The_Australia_ICOMOS_Charter_for_Places_of_Cultural_Significance_1999_International_Council_on_Monuments_and_Sites (Accessed: November 2020).
- CEN (2000) 'EN 13009 - Hygrothermal performance of building materials and products - Determination of hygric expansion coefficient'.
- CEN (2010). 'EN 15886 Conservation of cultural property - Test methods - Colour measurement of surfaces'.
- Cennini, C. (1859). *Il libro dell'arte, o Trattato della pittura*. 2014th ed. Edited by G. Milanesi and C. Milanesi. Firenze: F. Le Monnier. Available at: e-text.it.
- Chelazzi, D. Poggi, G., Jaidar, Y., Toccafondi, N., Giorgi, R. and Baglioni, P. (2013). 'Hydroxide nanoparticles for cultural heritage: Consolidation and protection of wall paintings and carbonate materials', *Journal of Colloid and Interface Science*. Elsevier Inc., 392(1), pp.42–49. doi: 10.1016/j.jcis.2012.09.069.
- Council of Europe (1991). *Recommendation No. R (91) 13 on the protection of the twentieth century Architectural Heritage*. Available at: <https://rm.coe.int/CoERMPublicCommonSearchServices/DisplayDCTMContent?documentId=09000016804bde8d> (Accessed: 1 May 2021).
- Cowan, H. J. and Smith, P. R. (2004). *Dictionary of Architectural and Building Technology*. 4th edn, London & New York: Routledge. doi: 10.4324/9780203786383.
- Cremers, J. (2016). *Building Openings Construction Manual*. Edited by J. Cremers. Munich: DETAIL. doi: 10.11129/9783955532994.
- Daniele, V., Taglieri, G., Macera, L., Rosatelli, G., Otero, J. and Charola, A.E. (2018). 'Green approach for an eco-compatible consolidation of the Agrigento biocalcarene surface', *Construction and Building Materials*. Elsevier Ltd, 186, pp.1188–1199. doi: 10.1016/j.conbuildmat.2018.08.033.
- Denslagen, W.F. (1987). *Omstreden Herstel : Kritiek Op Het Restaureren Van Monumenten : Een Thema Uit De Architectuurgeschiedenis Van Engeland, Frankrijk, Duitsland En Nederland (1779-1953)*.

- Ditaranto, N., Loperfido, S., Werf van der, I., Mangone, A., Cioffi, N. and Sabbatini, L. (2011). 'Synthesis and analytical characterisation of copper-based nanocoatings for bioactive stone artworks treatment', *Analytical and Bioanalytical Chemistry*, 399(1), pp. 473–481. doi: 10.1007/s00216-010-4301-8.
- Doehne, E. and Price, C. A. (2011). *Stone Conservation: An Overview of Current Research*, 2nd edition, Book. doi: 10.1016/0006-3207(70)90031-5.
- Drdácký, M., De Ferri, L., Lottici, P.P., Lorenzi, A., Montenero, A. and Salvioli-Mariani, E. (2012). 'Standardization of peeling tests for assessing the cohesion and consolidation characteristics of historic stone surfaces', *Materials and Structures*, 45(4), pp.505–520. doi: 10.1617/s11527-011-9778-x.
- Dubelaar, C.W., Nijland, T.G. en Tolboom, H.J. (red.) (2007). *Utrecht in Steen*, Uitgeverij Matrijs, Utrecht.
- Dusar, M., Nijland, T.G. (2012). 'Spoorwegen als 'enabling technology' voor de architectuur: Veranderend natuursteengebruik in 1860-1960.', In: Hees van R.P.J., Clercq De H., Quist W.J. (red.). *Stenen van binnen, stenen van buiten - natuursteen in de jonge bouwkunst*, Delftdigitalpress.
- Elk, S. J. (1985). *Scholarly Commons Theses (Historic Preservation) Graduate Program in Historic Preservation Pigmented Structural Glass and the Storefront Part of the Historic Preservation and Conservation Commons*. University of Pennsylvania. Available at: http://repository.upenn.edu/hp_theseshttp://repository.upenn.edu/hp_theses/330 (Accessed: 1 May 2021).
- English Heritage (2012). *Practical Building Conservation – Stone*, Routledge.
- ERM Restauratieladder (2020). <https://www.stichtingerm.nl/professionals-monumentenzorg/restauratieladder-als-leidraad/alles-over-de-restauratieladder> Accessed: November 15.
- European Committee for Standardization (2018). EN 12519:2018 - Windows and pedestrian doors - Terminology.
- Fagan, E. and Brammer, A. (2015). *Building Walls of Light: The Development of Glass Block and Its Influence on American Architecture in the 1930s*. doi: 10.7916/D8416W87.
- Ferreira Pinto, A. P. and Delgado Rodrigues, J. (2004). 'Study of consolidation effects in carbonate stones by means of drilling resistance', 6th International Symposium on the Conservation of Monuments in the Mediterranean Basin, (DECEMBER 2015).
- Ferri de, L., Lottici, P.P., Lorenzi, A., Montenero, A. and Salvioli-Mariani, E. (2011). 'Study of silica nanoparticles - polysiloxane hydrophobic treatments for stone-based monument protection', *Journal of Cultural Heritage*, 12(4), pp. 356–363. doi: 10.1016/j.culher.2011.02.006.
- Franzoni, E. (2018). 'State-of-the-art on methods for reducing rising damp in masonry', *Journal of Cultural Heritage*. Elsevier Masson SAS, 31, pp.S3–S9. doi: 10.1016/j.culher.2018.04.001.
- Franzoni, E., Sassoni, E. and Graziani, G. (2015). 'Brushing, poultice or immersion? The role of the application technique on the performance of a novel hydroxyapatite-based consolidating treatment for limestone', *Journal of Cultural Heritage*. Elsevier Masson SAS, 16(2), pp.173–184. doi: 10.1016/j.culher.2014.05.009.
- Frattini, F., Rescic, S. and Tiano, P. (2007). 'A new portable system for determining the state of conservation of monumental stones', *Materials and Structures*, 39(2), pp.139–147. doi: 10.1617/s11527-005-9013-8.
- Gerber, M. and Eberschweiler, B. (2014) *ENERGIE UND BAUDENKMAL Ein Handbuch: Fenster und Türen*. V1 edn, ENERGIE UND BAUDENKMAL. V1 edn. Zürich: Kantonale Denkmalpflege Bern Kantonale Denkmalpflege Zürich. Available at: https://www.erz.be.ch/erz/de/index/kultur/denkmalpflege/publikationen/handbuch_energieundbaudenkmal.html. (Accessed: 3 January 2021).
- Graziani, G., Sassoni, E. and Franzoni, E. (2016). 'Experimental study on the salt weathering resistance of fired clay bricks consolidated by ethyl silicate', *Materials and Structures/Materiaux et Constructions*. Springer Netherlands, 49(7), pp.2525–2533. doi: 10.1617/s11527-015-0665-8.
- Guimarães, A. S., Delgado, J. M. P. Q. and de Freitas, V. P. (2016). 'Treatment of rising damp in historic buildings: Experimental campaign of wall base ventilation and interface effect analysis', *Journal of Cultural Heritage*, 20, pp.733–738. doi: 10.1016/j.culher.2016.02.012.
- Hall, C. and Hoff, W. (2007). 'Rising damp: capillary rise dynamics in walls', *Proc. R. Soc. A*, 463, p.1871–1884.
- Haslinghuis, E. J. (Edward J. and Janse, H. (Herman) (1997). *Bouwkundige termen?: verklarend woordenboek van de westerse architectuur en bouwhistorie*. 3rd edn. Utrecht: A. Oosthoek's Uitgevers- maatschappij NV: Primavera Pers.
- Hees van, R. P. J., Koek, J. A.G., H. Clercq De, E. Witte De, Binda L., Ferrieri E.D., Carraro E. (1998). 'The assessment of the performance of surface treatments in the field. Results of 60 case studies confronted with lab results', in R. P. J. van Hees (ed.) *Evaluation of the performance of surface treatments for the conservation of historic brick masonry - Final report of EU project*. European Commission, pp.33–54.
- Hees van, R. P. J. and Koek, J. (1996). *Optrekkend vocht*. Handleiding voor de bestrijding, Rotterdam, Stichting Bouwresearch.
- Hees van, R.P.J. & Naldini, S. (2020). 'MDCS, A system for Damage Identification and Monitoring', in: Vandesande, A. (Eds.), Verstrynge, E. (Ed.), Balen Van, K. (Eds.). *Preventive Conservation - From Climate and Damage Monitoring to a Systemic and Integrated Approach*. London: CRC Press, / Balkema, Taylor & Francis group pp.113-118.
- Hees van, R. P. J., Naldini, S. and Delgado, J. (2008). 'Plasters and renders for salt laden substrates', *Construction and Building Materials*. Elsevier Ltd, 23(5), pp.1714–1718. doi: 10.1016/j.conbuildmat.2008.09.009.

- Helm van der, F., Rooden van, M., Rooden van, J. and Sluys van der, M. (1994). 'Hydrofoberen van gevels', RDMZ info restauratie en beheer, 1.
- Henry, A. (2006). *Stone conservation : principles and practice*. Donhead, books.google.com
- Hildebrand, L. and Doctor, D. (2013). *Product Development and Architecture, Product Development and Architecture*. Edited by U. Pottgiesser and H. Strauß. Basel: DE GRUYTER. doi: 10.1515/9783034608824.
- Histoglass (2010). *Thin Double Glazing Thin Double Glazing for the Restoration of Period Properties*. Available at: www.histoglass.co.uk (Accessed: 1 March 2021).
- Horowitz, A.D., Lopez, M.F., Ross, S.M. and Sparenberg, J.A. (2016). 'Climate Change and Cultural Heritage Conservation a Literature Review', APT Technical Committee on Sustainable Preservation's Education and Research focus group, (July). Available at: http://www.apti.org/clientuploads/TechnicalCommittees/2015-2016/APT_TC-SP_Literature_Review_Climate_Change_Cultural_Heritage_Conservation_2016June30.pdf.
- Hudd, F. (2010). 'Issues surrounding the Conservation of Vitrolite glass', *Journal of Architectural Conservation*, 16(2), pp.45–63. doi: 10.1080/13556207.2010.10785069.
- IC Interconnection Consulting (2019). *IC Market Forecast, Fenster in Europa 2019*. Available at: <https://www.interconnectionconsulting.com/en/market-reports/> (Accessed: 1 March 2021).
- ICOMOS-ISCS (2008). *Illustrated glossary on stone deterioration patterns* (https://www.icomos.org/publications/monuments_and_sites/15/pdf/Monuments_and_Sites_15_ISCS_Glossary_Stone.pdf, visited June 18, 2021)
- Janse, H., Vries de, D.J. (1991). *Werk en merk van de steenhouwer: het steenhouwersambacht in de Nederlanden voor 1800, Waanders, Zeist en Rijksdienst voor de Monumentenzorg, Amersfoort*.
- Jokilehto, J. A (1986). *History of Architectural Conservation. The Contribution of English, French, German and Italian Thought towards an International Approach to the Conservation of Cultural Property*. D.Phil Thesis, The University of York, England.
- Jokilehto, J. (2020). *History of Architectural Conservation*. Burlington: Elsevier; 2002. E-book Delft University of Technology, accessed November 15.
- Kalf, J. (red.) (1917). *Grondbeginselen en voorschriften voor het behoud, de herstelling en de uitbreiding van oude bouwwerken*, Leiden.
- Kim, E. K. , Won, J., Do, J., Kim, S.D. and Kang, Y.S. (2009). 'Effects of silica nanoparticle and GPTMS addition on TEOS-based stone consolidants', *Journal of Cultural Heritage*, 10(2), pp.214–221. doi: 10.1016/j.culher.2008.07.008.
- Klos, H. and Rottweil, H. (2012). 'Das Fenster im 20. Jahrhundert. Metallfenster', in *Monument Preservation in Baden-Württemberg*. 41st vol.
- Klos, H., Rottweil, H. and Fenster, D. (2011). *Die Historische Entwicklung von Glasfenster-Verschlässen in Mitteleuropa*, in *Holzfenster- und türen Band II*. Rudolf Müller GmbH & Co. KG.
- Koolhaas R., AMO and Harvard Graduate School of Design (2018). *Elements of Architecture: Window, façade, balcony, corridor, fireplace, stair, escalator, elevator*. Edited by James Westcott and Stephan Petermann. Taschen. Available at: <https://oma.eu/publications/elements-of-architecture> (Accessed: 31 May 2021).
- Kooten, C. van, Tolboom, H.J., Hof Van 't, J., Kussendrager C., Terwen, P., Verhulst, N., Niël M., Ende van den, K., Boon, M., Spee, M., Nijland, T., Quist, W., Druten van, S. Gerdessen, L., Janse, S., Joosten, I., Morelissen, R. (2012). *Natuursteenvisie - Handreiking voor de omgang met cultureel erfgoed van natuursteen*, Rijksdienst voor het Cultureel Erfgoed.
- Kuipers, M.C.K., Jonge De, W. (2017). *Designing from Heritage: Strategies for Conservation and Conversion*. TU Delft - Heritage & Architecture (Fac. Architecture) Rondeltappe series, book 3.
- Kuipers, M.C.K., Quist, W.J. (2013). *Culturele Draagkracht. Op zoek naar de tolerantie voor verandering bij gebouwd erfgoed*. Delft Digitalpress.
- Lewin, S. Z. (no date). 'The preservation of stone 1835-1965', *Art and Archeology Technical Abstracts*, 6/1, pp.185–277.
- Licchelli, M., Malagodi, M., Weththimuni, M. and Zanchi, C. (2014). 'Nanoparticles for conservation of bio-calcarene stone', *Applied Physics A: Materials Science and Processing*, 114(3), pp.673–683. doi: 10.1007/s00339-013-7973-z.
- Lubelli, B. and Hees van, R P.J. (2012). *Onderzoek naar schade aan de pleister van de Elleboogkerk te Amersfoort - TNO report 2012 R10706*. Delft.
- Lubelli, B. and Hees van, R. P. J. (2004). 'Laboratory Tests on the Behaviour of Cream Surface Treatments Applied on Brick and Stone', 6th International Symposium on the Conservation of Monuments in the Mediterranean Basin, Lisbon 6 – 10 April 2004, (table 2), pp.2–7.
- Lubelli, B., Hees, R. P. J. and Bolhuis, J. (2018). 'Effectiveness of methods against rising damp in buildings: Results from the EMERISDA project', *Journal of Cultural Heritage*. doi: 10.1016/j.culher.2018.03.025.
- Lubelli, B., Hees van, R. P. J., Groot, C. and Gunneweg, J. (2007). 'Risks of the Use of Water Repellents on Salt Contaminated Masonry: the Case of a Windmill in the Netherlands / Risiken beim Hydrophobieren von salzhaltigem Mauerwerk Fallstudie anhand einer Windmühle in den Niederlanden', *Restoration of Buildings and Monuments*, 13(5), pp.319–330. doi: 10.1515/rbm-2007-6154.
- Lubelli, B., Hees van, P.P.J., Hunen van, M., Nijland, T.G., Quist, W.J. (2018). *Steenreparatiemortels – Onderzoek naar het gedrag en de duurzaamheid van reparatiemortels in het lab en de praktijk*. Rapport in het kader van MonumentenKennis, Delft.

- Lubelli, B., Hees van, R. P. J., Miedema, L. and Fugazzotto, M. (2016). 'Electro-physical' methods to stop rising damp . assessment of the effectiveness in two case studies', in Rörig-Dalgaard, I. and Ioannou, I. (eds) International RILEM Conference on Materials, Systems and Structures in Civil Engineering Conference - Historical Masonry. Copenhagen: RILEM Publications S.A.R.L.
- Lubelli, B., Hees van, R. P. J. and Nijland, T.G. (2012). 'Oppervlaktebehandeling van historisch metselwerk', *Historisch metselwerk*, pp.237–251.
- Lubelli, B., Nijland, T.G., Hees van, R.P.J. (2021). Characterization and compatibility assessment of commercial stone repair mortars, *Journal of Cultural Heritage*, Volume 49, p.174-182, ISSN 1296-2074, <https://doi.org/10.1016/j.culher.2021.02.001>.
- Massari, G. and Massari, I. (1985). 'Damp buildings, old and new', *Bulletin of the Association for Preservation Technology*, 17(1), pp.2–30.
- Matteini, M., Rescic, S., Fratini, F. and Botticelli, G. (2011). 'Ammonium Phosphates as Consolidating Agents for Carbonatic Stone Materials Used in Architecture and Cultural Heritage: Preliminary Research', *International Journal of Architectural Heritage*, 5(6), pp.717–736. doi: 10.1080/15583058.2010.495445.
- Mittag M. (1957). *Baukonstruktionslehre: Ein Nachschlagewerk für den Bauschaffenden über Konstruktionssysteme, Bauteile und Bauarten*. 2012th edn. Vieweg & Teubner. Available at: <https://www.zvab.com/products/isbn/9783322830203/30744037768> (Accessed: 31 May 2021).
- Meurs, P. (2017). *Heritage-based design*, TU Delft - Heritage & Architecture (Fac. Architecture), Rondeltappe series, book 2.
- Mosquera, M. J., De Los Santos, D. M., Montes, A. and Valdez-Castro, L. (2008). 'New nanomaterials for consolidating stone', *Langmuir*, 24(6), pp.2772–2778. doi: 10.1021/la703652y.
- Myers, J. H. (1981). *Preservation Briefs: 9 The Repair of Historic Wooden Windows*, Heritage Preservation Services. Washington D.C. Available at: <https://www.nps.gov/tps/how-to-preserve/preservedocs/preservation-briefs/09Preserve-Brief-Wooden-Windows.pdf>. (Accessed: 1 May 2021).
- Nara charter (1994). International Council On Monuments and Sites, The Nara Document on Authenticity, <https://www.icomos.org/charters/nara-e.pdf> (accessed June 2021).
- Naldini, S. (2016). 'De historische en esthetische waarde van muur- en plafondufwerkingen', In: T.G. Nijland (Ed.), *Mortels technisch en bouwhistorisch bekeken: Syllabus TNO-NvMZ studiedag* (pp.51-75). TNO, Delft.
- Naldini S., Hees van, R., Grijp v. E. (2020). 'Integrated Conservation strategies in the Netherlands', S., XII Inter. Conference on Structural Analysis, Barcelona, 16-18 Sept. , Accepted for publication
- Naldini S., Hunen van, M., (2019). 'Guidelines for quality of interventions in built Cultural Heritage', in: Balen K. Van, Vandesande A. (Eds.), *Professionalism in the Built Heritage Sector*, bookseries: Reflections on Cultural Heritage Theories and Practices, vol: 4, CRC Press / Balkema, Taylor & Francis group, pp.87-93.
- Naldini S., Varst de, G., Koning de, S., Grijp van de, E. (2020). 'Quality of restoration of monuments: the role of Monumentenwacht', in: Balen Van K., Vandesande A. (Eds.). *Preventive Conservation*, CRC Press / Balkema, Taylor & Francis group, pp.71-76.
- Naldini, S., Witte De, E. and Carraro, E. (1998). 'Attitude of the responsible authorities for the conservation of monuments towards surface treatments', in van Hees, R. P. J. (ed.) *Evaluation of the performance of surface treatments for the conservation of historic brick masonry-Final report of EU project*, pp.23–32.
- Natali, I., Tomasin, P., Becherini, F., Bernardi, A., Ciantelli, C., Favaro, M., Favoni, O., Forrat Pérez. V. J., Olteanu, I. D, Sanchez, M., Vivarelli, A. and Bonazza, A. (2015). 'Innovative consolidating products for stone materials: field exposure tests as a valid approach for assessing durability', *Heritage Science*, 3(1), p. 6. doi: 10.1186/s40494-015-0036-3.
- Nijland, T.G.. (2013). 'Reinigen en retoucheren. De restauratie van de zandsteengevels van het Koninklijk Paleis Amsterdam'. In: *Bulletin KNOB vol 112 nr. 2*, p.112-121.
- Nijland, T.G., Adan, O. C. G., Hees van, R. P. J. and Etten van, B. D. (2009). 'Evaluation of the effects of expected climate change on the durability of building materials with suggestions for adaptation', *Heron*, 54(1), pp.37–48.
- Nijland, T.G., Larbi, J.A. (2010). 'Microscopic examination of deteriorated concrete'. In: Maierhofer, C., Reinhardt, H-W., (eds), *Woodhead Publishing Series in Civil and Structural Engineering, Non-Destructive Evaluation of Reinforced Concrete Structures*, Woodhead Publishing, p.137-179.
- Nijland, T.G., Quist, W.J.. (2017). *Historische oppervlaktebehandelingen voor de conservering van steenachtige materialen (natuursteen, beton, metselwerk) in Europese context*, TNO rapport 060.12579.
- Nijland, T.G., Zundert van, K., Lubelli, B. and Hunen van, M. (2019). *Herhydrofoberen van gehydrofobeerd metselwerk?: effecten op de waterhuishouding* - TNO report 2019 R10354.
- NTHP (2012) *Saving Windows, Saving Money: Evaluating the Energy Performance of Window Retrofit and Replacement*. Washington. Available at: www.Preservationnation.org/issues/sustainability/green-lab/. (Accessed: 14 March 2021).
- Odenhaoven van J., (1997). *Woordenboek Bouwkunde Nederlands-Engels-Duits, Kluwer Techniek*. Available at: <https://vindboek.nl/kluwer-bouwkunde-woordenboek-9789075777307> (Accessed: 31 May 2021).
- Otero, J., Starinieri, V. and Charola, A. E. (2018). 'Nanolime for the consolidation of lime mortars: A comparison of three available products', *Construction and Building Materials*. Elsevier Ltd, 181, pp.394–407. doi: 10.1016/j.conbuildmat.2018.06.055.
- Pender, R. and Godfraind, S. (2012). *Glass & Glazing. Historic England* Ashgate. Available at: <https://historicengland.org.uk/images-books/publications/glass-glazing-conservation/>.

- Pickles, D. (2016). 'Energy efficiency and historic buildings: Draught-proofing Windows and doors', *English Heritage*, (V1.1), pp.16–17. doi: 10.1108/ss.2011.11029caa.019. (Accessed: 3 January 2021).
- Pickles, D., McCaig, I., Wood, C., Molyneux, N. and Makri, E. (2017). 'Traditional Windows: Their Care, repair and Upgrading', *English Heritage*, p.74. Available at: <https://historicengland.org.uk/images-books/publications/traditional-windows-care-repair-upgrading/heag039-traditional-windows-revfeb17/>. (Accessed: 3 January 2021).
- Pinto, A. P. F. and Rodrigues, J. D. (2008) 'Stone consolidation: The role of treatment procedures', *Journal of Cultural Heritage*, 9(1), pp.38–53. doi: 10.1016/j.culher.2007.06.004.
- Pottgiesser, U. and Kirch, J. (2010). 'Renovating Modern Movement Facades in Line with Landmark Preservation Principles', in *Old and New - Design Manual for Revitalizing Existing Buildings*. Birkhäuser, pp.118–129. doi: 10.1515/9783034611602.119.
- Price, C. . (1996). *Stone Conservation - An overview of Current Research*. GCI Publications | NGA | National Glass Association (2021). Available at: <https://www.glass.org/resources/publications> (Accessed: 3 January 2021).
- Quist, W.J (2011). *Vervanging van witte Belgische steen: materiaalkeuze bij restauratie*. Technische Universiteit Delft (325 pp.). Promotor: Prof.ir. RPJ van Hees.
- Quist, W.J. (2012). 'Steenkeuze voor restauratie: 150 jaar ontwikkeling in Nederland en Vlaanderen'. In: Clercq De, H., Gemert Van, D. & Hees van, R. (eds.), *Syllabus WTA-studiedag Natuursteen natuurlijk!?*, WTA Nederland - Vlaanderen, p.114-14.
- Quist, W.J. (2012). *Duurzaamheid als keuzeargument bij de vervanging van natuursteen*. In: Nijland, T.G. (ed.) *Syllabus Duurzame instandhouding*, TNO - NVMz studiedag, p.17-31.
- Quist, W.J., Nijland, T.G. & Hees, van R.P.J. (2013) 'Replacement of Eocene white sandy limestone in historical buildings: over 100 years of practice in the Netherlands', in: *Quarterly Journal of Engineering Geology and Hydrogeology*, p.1-9.
- Quist, W.J. & Nijland, T.G. (2013). 'Een mijningenieur tussen de monumentenzorgers'. In: *Bulletin KNOB vol 112 nr. 4*, p.204-224.
- Quist, W.J. & Tolboom H.J. (Eds.). (2017). *Natuursteen in Limburg – Natuursteen uit Limburg*. Delft: Delftdigitalpress.
- Rexroth, S., Mertes, A. and Thurow, K. (2020). *Verglasungssysteme für Fensteranierungen im Berliner Gebäu- debestand – Energie, CO2 und Wirtschaftlichkeit im Einklang*. Berlin. Available at: <https://fenstervergleich.htw-berlin.de/index.php/forschungsprojekt/zusammenfassung/>. (Accessed: 23 May 2021).
- Rijksdienst voor Archeologie, Cultuurlandschap en Monumenten. (2004a). *Het conserveren en repareren van historische houten vensters en deurpartijen*. 2nd edn, Rijksdienst voor de Monumentenzorg. 2nd edn. Edited by M. van Rooden et al. Utrecht: Utrecht Printing Hoonte Bosch & Keuning. Available at: <https://www.cultureelerfgoed.nl/publicaties/publicaties/2004/01/01/het-conserveren-en-repareren-van-historische-houten-vensters-en-deurpartijen>.
- Rijksdienst voor Archeologie, Cultuurlandschap en Monumenten. (2004b). *Onderhoud en restauratie van glas-in-lood*. 42nd edn. Edited by M. Bus et al. Utrecht: Rijksdienst voor het Cultureel Erfgoed. Available at: <https://www.cultureelerfgoed.nl/publicaties/publicaties/2004/01/01/onderhoud-en-restauratie-van-glas-in-lood>. (Accessed: 14 February 2021).
- Rijksdienst voor Archeologie, Cultuurlandschap en Monumenten. (2005). *Vensterglas*. Edited by K. Boeder et al. Utrecht. Available at: <https://www.cultureelerfgoed.nl/publicaties/publicaties/2005/01/01/vensterglas>.
- Rijksdienst voor Archeologie, Cultuurlandschap en Monumenten. (2006). 'Bouwglas', *RACM Brochure Techniek 46*, January, p.4. doi: 1569-7606. (Accessed: 14 February 2021).
- Rijksdienst voor Archeologie, Cultuurlandschap en Monumenten. (2008). *Stalen ramen en deuren*, *RACM brochure Techniek 48*, January, p.4. doi: 1569-7606. (Accessed: 14 February 2021).
- Rijksdienst voor Archeologie, Cultuurlandschap en Monumenten. (2012). *Historische vensters isoleren*. *Gids Cultuurhistorie 21*. Gids Cultu. Edited by Abeling R., Cornelissen G., Dijk van, G., Dolfin, M., Haitsma, H., Hermans, T., Jörg, E., Kok, M., Kooten, van C., Overbeek B., Pekaar, R., Stappers M., Takens, D., Westerman, J. Amersfoort: Rijksdienst voor het Cultureel Erfgoed. Available at: <https://www.cultureelerfgoed.nl/publicaties/publicaties/2012/01/01/historische-vensters-isoleren> (Accessed: 14 February 2021).
- Rodriguez-Navarro, C., Suzuki, A. and Ruiz-Agudo, E. (2013). 'Alcohol dispersions of calcium hydroxide nanoparticles for stone conservation', *Langmuir*, 29(36), pp.11457–11470. doi: 10.1021/la4017728.
- Ruffolo, S. A., La Russa, M. F., Aloise, P., Belfiore, C. M., Macchia, A., Pezzino, A. and Crisci, G. M. (2014). 'Efficacy of nanolime in restoration procedures of salt weathered limestone rock', *Applied Physics A: Materials Science and Processing*, 114(3), pp.753–758. doi: 10.1007/s00339-013-7982-y.
- Sabbioni, C., Brimblecombe, P. and Cassar, M. (2010). 'The Atlas of Climate Change Impact on European Cultural. Scientific Analysis and management strategies', in *Effect of climate change on cultural heritage*. Anthem Press.
- Sassoni, E., Franzoni, E., Pigino, B., Scherer, G. W. and Naidu, S. (2013). 'Consolidation of calcareous and siliceous sandstones by hydroxyapatite: Comparison with a TEOS-based consolidant', *Journal of Cultural Heritage*. Elsevier Masson SAS, 14(3 SUPPL), pp.e103–e108. doi: 10.1016/j.culher.2012.11.029.
- Sassoni, E., Naidu, S. and Scherer, G. W. (2011). 'The use of hydroxyapatite as a new inorganic consolidant for damaged carbonate stones', *Journal of Cultural Heritage*, 12(4), pp.346–355. doi: 10.1016/j.culher.2011.02.005.

Shanon Peterson Wasielewski (2004). *Windows: Energy Efficiency Facts and Myths*, Department of Archaeology and Historic Preservation. Available at: https://dahp.wa.gov/sites/default/files/Windows_Energy_Efficiency_Facts_and_Myths.pdf (Accessed: 14 May 2021).

Schittich, C., Staib, G., Balkow, D., Schuler, M. and Sobek, W. (2012). 'Frontmatter', in *Glass Construction Manual*. 2nd edn. Basel: Birkhäuser, pp.i–iv. doi: 10.11129/detail.9783034615549.fm.

SCHOTT AG (2019) GOETHEGLAS RESTOVER ® TIKANA ® Glass for Restoration. Mainz Germany. Available at: <https://www.schott.com/d/corporate/ac9803a8-b32a-483f-8567-d9c0a6dbc2ca/1.0/row-glass-for-restoration-brochure-datasheet-view-2019-08-07.pdf>.

SCHOTT AG (2020) Transport rollers Drawing direction glass sheet Glass melt Drawing nozzle Fourcault process SCHOTT Glasses for Restoration-Restoration and Conservation further thought Historical in form, inovative in function: UV and IR protection. Mainz, Germany. Available at: www.schott.com/restoration (Accessed: 1 March 2021).

Schuit van der, P. K. (1986a). 'Gevelreiniging, een monumentenzorg. Reinigingsmiddelen en -methoden voor gevels van oudere gebouwen', *Restauratievademecum*, 1.

Schuit van der, P. K. (1986b). 'Vochtwerking', *Restauratievademecum*, 01–1.

Schuit van der, P. K. (1994). 'Gevelreiniging', *Restauratievademecum*, 2–1.

Schuit van der, P. K. and Polder, R. (1992). 'Hydrofoberen van gevels; keuzehandleiding', *Restauratievademecum*, 1.

Schulz, D. (no date). *History and development of window glazing*. Available at: http://www.davinciglas.eu/NL/Glas_in_de_oudheid.pdf (Accessed: 31 May 2021).

Secundus, G. P. (1962). *Natural History*. Edited by J. Bostock. Available at: <http://www.perseus.tufts.edu/>.

Siegesmund, S. and Snethlage, R. (2011a) 'Stone conservation', in Siegesmund, S. and Snethlage, R. (eds) *Stone in Architecture: Properties, Durability*. Springer, pp.411–544. doi: 10.1007/978-3-642-14475-2.

Siegesmund, S. and Snethlage, R. (eds) (2011b). *Stone in architecture - Properties, Durability*. 4th edn. Springer. doi: 10.1007/978-3-642-14475-2.

Sierra-Fernandez, A., Gomez-Villalba, L. S., Rabanal, M. E. and Fort, R. (2017). 'New nanomaterials for applications in conservation and restoration of stony materials: A review', *Materiales de Construcción*, 67(325), p.107. doi: 10.3989/mc.2017.07616.

Slinger, A., Janse, H., Berends, G. (1980) (19822). *Natuursteen in monumenten, Zeist/Baarn*.

Slížková, Z., Drdácý M. and Viani, A. (2015). 'Consolidation of weak lime mortars by means of saturated solution of calcium hydroxide or barium hydroxide', *Journal of Cultural Heritage*, 16(4), pp.452–460. doi: 10.1016/j.culher.2014.09.003.

Slížková, Z. and Frankeová, D. (2012). 'Consolidation of porous limestone with nanolime-laboratory study', 12th International Congress on the Deterioration and Conservation of Stone, Columbia University, New York. Available at: <http://iscs.icomos.org/pdf-files/NewYorkConf/slizfran.pdf>.

Stazi, F., Muganesi, E. and Munafò, P. (2012). 'Recommendation for restoration of Modern buildings with stone cladding and steel windows: A multi-disciplinary approach on a significant case study', *Elsevier, (Construction and Building Materials 37)*, pp.728–737. doi: 10.1016/j.conbuildmat.2012.07.104.

Stichting ERM (2014). *Uitvoeringsrichtlijn Restauratie Steenhouwwerk* (URL 4007).

Teutonico, J. (1997). 'How can we ensure the responsible and effective use of treatment (cleaning, consolidation, protection.)?', in Baer, N. N. and Snethlage, R. (eds) *Saving our architectural heritage, The conservation of historic stone structures*. Wiley & Sons, pp.293–314.

Teutonico J.M., Charola A.E., Witte de E., Grasegger G., Koestler R.J., Laurenzi Tabasso M., Sasse H.R. and Snethlage R. 9 (1997). 'Group Report How Can We Ensure the Responsible and Effective Use of Treatments (Cleaning, Consolidation, Protection)?'. In: Baer N.S. and Snethlage R. (eds.), *Dahlem Workshop on Saving Our Architectural Heritage: Conservation of Historic Stone Structures*, Chichester, p.293-313.

Theodore H. M. Prudon (2008). *Preservation of Modern Architecture*. Hoboken, N.J.: John Wiley & Sons. Available at: <https://www.wiley.com/en-us/Preservation+of+Modern+Architecture-p-9780471662945> (Accessed: 31 May 2021).

Thomas C. Jester (1995). *Twentieth-Century Building Materials: History and Conservation*. 2004th edn. Edited by Thomas C. Jester. New York?: McGraw-Hill. Available at: https://www.getty.edu/conservation/publications_resources/books/20th_cent_building_materials.html (Accessed: 31 May 2021).

Tillema J.A.C. (1975). *Schetsen uit de geschiedenis van de monumentenzorg in Nederland, Staatsuitgeverij, Den Haag*.

Torres, I. (2018). 'New technique for treating rising damp in historical buildings: Wall base ventilation', *Journal of Cultural Heritage*. Elsevier Masson SAS, 31, pp.560–570. doi: 10.1016/j.culher.2018.04.015.

Torres, M. I. M. and Peixoto de Freitas, V. (2007). 'Treatment of rising damp in historical buildings: wall base ventilation', *Building and Environment*, 42(1), pp.424–435. doi: 10.1016/j.buildenv.2005.07.034.

United Nations Educational, Scientific and Cultural Organization, *Operational Guidelines for the Implementation of the World Heritage Convention*, World Heritage Centre (2019). <https://whc.unesco.org/en/guidelines/> Accessed June 2021.

- United States. Department of the Interior (2004). *The preservation of historic architecture?: the U.S. government's official guidelines for preserving historic homes*. Guilford, CT: Guilford, CT?: Lyons Press. Available at: <https://archive.org/search.php?query=source%3A%22%22> (Accessed: 1 May 2021).
- Vandevoorde, D., Pamplona, M., Schalm, O., Vanhellemont, Y., Cnudde, V. and Verhaeven, E. (2009). 'Contact sponge method: Performance of a promising tool for measuring the initial water absorption', *Journal of Cultural Heritage*. Elsevier Masson SAS, 10(1), pp.41–47. doi: 10.1016/j.culher.2008.10.002.
- Vanhellemont, Y., Bolhuis, J., de Bouw, M., Dubois, S., Lubelli, B., Miedema, L. and Hees van, R. P. J. (2018). 'Are electrokinetic methods suitable for the treatment of rising damp?', *Journal of Cultural Heritage*, 31S, pp.S23–S29. doi: 10.1016/j.culher.2018.04.010.
- Venice Charter (1964). International Council On Monuments and Sites, International Charter for the Conservation and Restoration of Monuments and Sites (The Venice Charter) https://www.icomos.org/charters/venice_e.pdf Accessed June 2021.
- VDL Vereinigung der Landesdenkmalpleger in der Bundesrepublik Deutschland (2017). *Holzfenster im Baudenkmal Hinweise zum denkmalgerechten Umgang*. Edited by Dipl. Ing. Frank Eßmann et al. Wiesbaden: Vereinigung der Landesdenkmalpleger in der Bundesrepublik Deutschland. Available at: https://www.vdl-denkmalpflege.de/fileadmin/dateien/Arbeitshefte/01_Fenster_im_Baudenkmal__2017__klein.pdf (Accessed: 3 January 2021).
- Vos, B. (1971). 'Suction of groundwater', *Studies in Conservation*, 16(4), pp.129–144. doi: 10.2307/1505493. Yang, F. W. Liu, Y., Zhu, Y.C., Long, S.J., Zuo, G.F., Wang, C. Q., Guo, F., Zhang, B.J. and Jiang, S. W. (2012) Conservation of weathered historic sandstone with biomimetic apatite, *Chinese Science Bulletin*, 57(17), pp.2171–2176. doi: 10.1007/s11434-012-5039-9.
- WDMA Window & Door Manufacturers Association (2021). *The Window Glossary*, Washington, D.C. Available at: <https://www.wdma.com/the-window-glossary> (Accessed: 3 January 2021).
- Wikipedia (2021). Window. *The Free Dictionary By Farlex*. Available at: https://en.wikipedia.org/wiki/Window#cite_note-britannica.com-1 (Accessed: 9 April 2021).
- Wiggington M. (1996). *Glass in Architecture*. Edited by Ian Ritchie for the Architects. London & New York: London?; New York, N.Y.?: Phaidon, 2004, 1996. Available at: <https://www.ianritchiearchitects.co.uk/literature/glass-in-architecture-by-michael-wiggington/> (Accessed: 31 May 2021).
- Williams, R. (2008). *Historic Wood Windows- A tip sheet from the national Trust for Historic Preservation*. Patrice Frey, Director of Sustainability Research. Available at: www.historichomeworks.com (Accessed: 1 May 2021).
- Window | Definition of Window by Merriam-Webster (2021). Available at: <https://www.merriam-webster.com/dictionary/window> (Accessed: 1 May 2021).
- World Heritage Convention (2019). <https://whc.unesco.org/en/guidelines/> (accessed June 2021).
- Zendri, E., Biscontin, Gu., Nardini, I. and Riato, S., (2007). 'Characterization and reactivity of silicatic consolidants', *Construction and Building Materials*, 21(5), pp.1098–1106. doi: 10.1016/j.conbuildmat.2006.01.006.
- Zornoza-Indart, A., López-Arce, P., Gómez-Villalba, L. S., Varas-Muriel, M. J. and Fort, R. (2012). 'Consolidation of deteriorated carbonate stones with Ca(OH)₂ nanoparticles', in 12th International Congress on the Deterioration and Conservation of Stone. New York.

Colophon

Published by

TU Delft - Heritage & Architecture (Fac. Architecture) on behalf of the Rondeltappe Bernoster Kemmers Foundation

The Rondeltappe Bernoster Kemmers Foundation was established in 1995 by architect Leendert Rondeltap from The Hague with the aim of purchase and conservation of Dutch Heritage Monuments.

Rondeltap was the architect of the Europa Hotel in The Hague, among other buildings, and was also professor Architectural Drawing at the Royal Academy of Visual Arts.

The Foundation can assign awards to private persons or institutions. In this framework, the Foundation has made a cooperation agreement with the Faculty of Architecture of TU Delft: during five years, starting in 2014, annual publications will be issued in the Rondeltappe book series. The publications will be used for the MSc education of the section Heritage & Architecture of the Faculty of Architecture and the Built Environment at Delft University of Technology

To learn more about the objects belonging to the Foundation please refer to the website: www.stichtingrbk.nl.

Thanks to

Foundation Rondeltappe-Bernoster-Kemmers (RBK, The Hague),

Ir. Michiel van Hunen, Specialist Conservation and Restoration of the Netherlands Cultural Heritage Agency and Ir. Geert van der Varst, Independent Consultant in Conservation and former director Monumentenwacht Limburg for reviewing this book.

English translation and copy editor

Dr. Nicholas Clarke

Series editor in chief

Dott. Silvia Naldini

Design

Sirene Ontwerpers, Véro Crickx



STICHTING
RONDELTAPPE
BERNOSTER
KEMMERS

TU Delft

Section Heritage & Architecture