



LIVING STATIONS

The Design of Metro Stations in the (east flank) metropolitan areas of Rotterdam

Edited by:

Manuela Triggianese
Olindo Caso
Yagiz Soylev

Layout Design:

Federica Longoni
Ian Omumbwa

Including contributions of:

Kees Kaan (TU Delft; AMS Institute)
Nacima Baron (University Gustave Eiffel Paris)

In collaboration with:

Wouter Kamphuis (Gemeente Rotterdam)
Marc Verheijen (Gemeente Rotterdam)

Students of the
elective studio:

AR0109
City of Innovations
Project,
Spring 2020,
TU Delft



**L I V I N G
S T A T I O N S**

The Design of Metro Stations in the (east flank) metropolitan areas of Rotterdam

Edited by:
Manuela Triggianese
Olindo Caso
Yagiz Soylev

Layout Design:
Federica Longoni
Ian Omumbwa

Including contributions of:
Kees Kaan (TU Delft; AMS Institute)
Nacima Baron (University Gustave Eiffel Paris)

In collaboration with:
Wouter Kamphuis (Gemeente Rotterdam)
Marc Verheijen (Gemeente Rotterdam)

Students of the
elective studio:

AR0109
City of Innovations
Project,
Spring 2020,
TU Delft

COLOPHON

M. Triggianese, O. Caso, Y. Soylev (eds.). *Living Stations. The Design of Metro Stations in the (east flank) metropolitan areas of Rotterdam*. TU Delft Open, Delft 2021.

This book is published by TU Delft Open
Faculty of Architecture and the Built Environment,
Delft University of Technology

(c) 2020 the authors and the Faculty of Architecture and the Built Environment, Delft University of Technology. All rights reserved.

ISBN 9789463663830

Edited by:

Manuela Triggianese
Olindo Caso
Yagiz Soylev

Imagery:

(c) Chair of Complex Projects, Department of Architecture, Faculty of Architecture and the Built Environment, Delft University of Technology
(c) Authors - Students unless otherwise stated.

Layout Design:

Federica Longoni
Ian Omumbwa

Including contributions of:

Kees Kaan (TU Delft; AMS Institute)
Nacima Baron (University Gustave Eiffel Paris)

In collaboration with:

Wouter Kamphuis (Gemeente Rotterdam)
Marc Verheijen (Gemeente Rotterdam)

Research Through Design elaborations in the case-study section of this book are done by the students of the elective studio City of Innovations Project (AR0109), spring 2020, TU Delft.

Elective Master Studio AR0109

City of Innovations Project (*)
Living Stations Rotterdam
Chair of Complex Projects, Spring 2020

Chair Professor

prof. ir. Kees Kaan

Coordination:

dr. Olindo Caso
dr. Manuela Triggianese

Students

Alice Lee, Anna Shishkina, Bethany Kiss, Birte Zacharias, Coen Jager, Diego Toribio Álvarez, Ervin Muhovic, Gerjan Agterhuis, Giannis Nikiforou, Hannah Zhu, I-Hsuan Lee, Isaac Vaarzon Morel, Izk Chan, Jasmin Goldberg, Jemina Lai, Jesse Verdoes, Julia Linde, Julianne Guevara, Julka Veerman, Laura Sacchetti, Lorenzo Bondavalli, Maciej Moszant, Matteo Gumirato, Maxwell McGrath, Maya de Ridder, Nigel Flanagan, Qi Hao, Rogier Tamminga, Romy Weeteling, Siddharth Agarwal, Sofia Pavlova, Su Gu, Tamas Dongo, Wessel Herrewijnen

Studio Leaders:

dr. Olindo Caso / TU Delft
ir. Wouter Kamphuis / Gemeente Rotterdam
ir. Yagiz Soylev / TU Delft
ir. Marc Verheijen / Gemeente Rotterdam

Teaching Assistant

Ian Omumbwa

* City of Innovations Project is an education format ideated and developed by dr. Manuela Triggianese for the Master curriculum of the Chair of Complex Projects, Faculty of A+BE, TU Delft. 'City of Innovations Project' connects academic research and education with stakeholders for addressing actual urban challenges. The Spring 2020 edition has enjoyed the partnership of Municipality Rotterdam.

CONTENT

Preface	V
Foreword	VII
Essays	02
Workshop Paris - Delft	31
Rotterdam: 10 Visions x 5 Locations	39

LIVING STATIONS

The Design of Metro Stations in the (east flank) metropolitan areas of Rotterdam



About the Book & Work

Manuela Triggianese, Olindo Caso, Yagiz Soylev

Due to the growing demand for mobility (as a primary need for people to get to work, to obtain personal care or to go travelling), cities continue to be faced with new urban challenges. Stations represent, along mobility networks, not only transportation nodes (transfer points) but also architectural objects which connect an area to the city's territorial plane and which have the potential to generate new urban dynamics. In the 'compact city' the station is simply no longer the space to access mobility networks, as informed by their dry pragmatism, but becomes an urban place of sociality and encounter - an extended public space beyond mobility itself. Which relationships and cross-fertilizations can be significant for the design of the future **living stations** in the Municipality of Rotterdam? How ought these stations to be conceived in order to act as public places for collective action? Which (archetypical) devices can be designed to give a shape to the ambitions for these stations? The station as a public space and catalyser for urban interventions in the metropolitan area of Rotterdam is the focus of the research initiative presented in this publication.

City of Innovations Project – Living Stations is organised around speculating and forecasting on future scenarios for the city of Rotterdam. 'What is the future of Rotterdam with the arrival of a new metro circle line system?' In the past fifty years, every decade of Rotterdam urban planning has seen its complementary metro strategy, with profound connections with the spatial planning and architectural themes. Considering the urban trends of densification and the new move to the city, a new complementary strategy is required. The plans to realize 50.000 new homes between the city centre and the suburban residential districts in the next 20 years go together with the development of a new metro circle line consisting of 16 new stations; 6 of which will connect the new metro line to the existing network. Students have been asked to develop ambitious but plausible urban and architectural proposals for selected locations under the guidance of tutors from the Municipality of Rotterdam and Complex Projects. The Grand Paris Express¹ project in France has inspired the course's approach.

Following the critical essays on the strategic role of the infrastructural project for city development interventions, the '**10 Visions X 5 Locations**' chapter is a systematization of the work of 35 master's students with input from designers of the City of Rotterdam and experts and academic from the University of Gustave Eiffel in Paris. The research-through-design process conducted in the City of Innovations project - Living Stations consists of documenting and analysing the present urban conditions of selected station locations in the City of Rotterdam and proposing design solutions and visualisations of the predicted development of these locations.

¹<https://www.societedugrandparis.fr/info/grand-paris-express-largest-transport-project-europe-1061>

FOREWORD



Foreword

Kees Kaan

In the elective *City of Innovations*, at the Chair of Complex Projects, we worked in close collaboration with the Municipality of Rotterdam on an education and research project that is studying the Rotterdam Circle Metro Line (a city proposal) as a living laboratory. In our education program, as illustrated in this publication, we use the design of strategic urban interventions as a didactic research tool. The objective is to encourage students to develop an open and curious attitude about design questions and develop simple and clear narratives to arrive at design solutions and products of communication. Notably on the subject of large-scale projects such as the development of rail-metro stations, the interplay between multiple actors and the complex interventions introduce another dimension. Here the notions of ‘learning through doing’ and ‘thinking through design’ are important¹. Architect and engineers start simultaneously and work concurrently on many aspects of the design of a complex project. This continues all the way to construction, and beyond that to operation and lifetime cycle of the building. Design tools, drawings, renders, models, infographics, not only serve as design tools to present models of a possible future but they are also the tools for this communication itself. Simple narratives supported by clear design are becoming the language in this process. Simple as opposed to complex is used here to emphasize importance of clarity in the narrative to allow minds to join and contribute in an effective way to manage the complexity.

City of Innovations positions itself as a negotiation between architecture, network infrastructure, public realm, policy and governance in the metropolitan territory. It applies **design research** to unravel concrete socio-spatial issues by operating on different design scales. The very ambitious and exploratory architectural proposals of the students arose in workshop settings which combined individual work with group design research. Students were invited to analyse and reflect on the importance of transport networks within- and extending from the city through designing narratives. They were urged to (re)consider the way these networks have shaped the city, weaving the urbanities of the city centre(s) and suburban areas and explore how they will further shape the territory.

The initiative presented in this book is a follow up of previous experiences of Complex Projects on working with external stakeholders and using design research as a didactic approach to understand mobility and other urban challenges in contemporary metropolitan contexts. The results of those experiences have been published in *Stations as Nodes* (2018)² and *Amsterdam 2050 Complex Projects* (2019)³ outputs.

¹ Kaan, K., Triggianese, M. Mobility as a driver of urban change, in Triggianese, M., Cavallo, R., Baron, N., Kuijper, J. *Stations as nodes*, TU Open, 2018 (pp25-29)

² Triggianese, M., Cavallo, R., Baron, N., Kuijper, J. *Stations as Nodes - exploring the role of stations in future metropolitan areas from a French and Dutch perspective*, TU Open, 2018

³ Kaan, K., Stancic, I., Triggianese, M., Smidihen, H., van Zalingen, J. *Amsterdam 2050: Complex Projects*, TU Open, 2019.

ESSAYS

Living Stations for Hybrid Urban Configurations Olindo Caso	02
Stations as a Lever for Inclusive Growth Manuela Triggianese	08
The Art of Designing Infrastructure Marc Verheijen	16
Railway Station Projects in Greater Paris Nacima Baron	22



Living Stations for Hybrid Urban Configurations

Olindo Caso

More than ever before, cities today are the frontrunners in social, economic, cultural innovations. They attract new inhabitants for they produce opportunities for many. Especially large cities are in the focus of complex migration fluxes from (peripheral) national and international regions,¹ fostering diversity and cultural multiplicity and raising relevant management issues: social cohesion, spatial and environmental qualities, variable time-space geographies, sustainable economies and ecologies. In the near future, these dynamics will increase the pressure on cities and territories. What new urban configurations emerge from these processes?

The larger cities in the Netherlands do not escape the urbanization trends. Amsterdam and Rotterdam are experiencing raising demands and are preparing plans to accommodate the expected population growth.² However, the specific territorial conditions of the Netherlands, and in particular of the Randstad Holland, makes it difficult to manage the growth by strategies of expansion. Large Dutch cities have reached their limits; space must now be found inside the existing boundaries. Strategies of densification and transformation are required, that are able to intensify the use of the existing urban ground by accommodating multiple programmatic dimensions. For doing this, new opportunities are to be found in underused / interstitial areas, in a smart re-use of the existing, or by expanding into the air and/or under the ground. Dutch cities are therefore exploring urban configurations that are dense and compact, where the scarce spatial resources are precious: a multiple use of ground in time and space, a more efficient exploitation of the urban area. This approach explicitly demands place-making operations that create local identities and that establish active urban roles in the different city parts. Space is transformed in place by equipping it with specific combinations of spatial and programmatic characters, in which architectural devices often operate as agents of identification. A dense patchwork of architectural signs,

programmatic diversity and local identities describes well these *compact urban configurations* in the making. A crucial planning aspect for these configurations is to organize this plural patchwork into a cooperative urban system, interlinking city locations and opportunities to give form to an interconnected urban field. For doing this, efficient matches between local qualities and reachability are essential. Therefore, a high-value, integrated interurban³ mobility network is a necessary condition to make the local qualities and opportunities thrive, and hold them accessible to a wider pool of people. A good-working mobility network minimizes the risks of fragmentation and segregation, and maximizes the advantages of time and space compression.⁴ This is true for the (large) Dutch cities too, which keep investing in the modernization and expansion of their urban infrastructures, in this way improving interurban mobility also beyond *mainports* and central stations.⁵ This approach is meaningful for the way people use and experience the living context. How does the integration of urban infrastructures in compact urban configurations influence collective life in cities, and thus their public places?

The hundreds of thousands movements flowing through the interconnected corridors and gates of the urban infrastructures, promote the interurban travels into central experiences in the daily behaviour of urban dwellers, therefore pushing the micro-hubs of mobility to the forefront of urban life. Due to their position in the local socio-spatial geographies, these *small stations*⁷ in the urban networks have a central meaning for the collective behaviour, as obvious places of encounter, meeting, exchange, serendipity. For this, the design of these small interurban stations is a key assignment in compact configurations, especially when we recognize their value for the collective. Their role of public anchors in the daily action-spaces of people requires new narratives and designs that celebrate this *collectiveness in motion* as significant representation of the multiplicity

¹ Urbanization is a global phenomenon. According to UN data (2018), already today 55% of world population lives in cities; and the expectation is 68% by 2050 (<https://www.un.org/development/desa/en/news/population/2018-revision-of-world-urbanization-prospects.html>). Larger cities and cities in wealthier countries are the main attractors in the urbanisation trends. They are not only absorbing from rural areas, but also from smaller cities and peripheral areas.

² Over the past five years, Amsterdam population has grown by 11.000 per year (CBS: <https://www.cbs.nl/en-gb/news/2017/45/amsterdam-is-expanding-mainly-due-to-immigration>). In 2040, Amsterdam municipality expects to need 70.000 additional dwellings with all the related amenities and services (Structuur Visie Amsterdam 2040: <https://131f4363709c46b89a6ba5bc764b38b9.objectstore.eu/hior/>

Documenten/Structuurvisie%20Amsterdam%202040%20(2011).pdf). In the same year 2040, Rotterdam expects to need 50.000 new dwellings for accommodating the rising population (Strategische Verkenning Verstedelijking, Rotterdam 2019: https://rotterdam.raadsinformatie.nl/document/7827160/1/s19bb017999_3_50801_tds). The increasing demand for dwellings goes hand in hand with a corresponding demand for services, amenities, work.

³ In this article, *interurban* refers to the connections among urban places within the city. In the same way, with *interurban stations* we intend the local mobility centres (or hubs) inside the city.

⁴ The growing population in the larger Dutch cities is essentially due to immigration (PBL 2019: <https://www.pbl.nl/publicaties/trek-van-en-naar-de->

of urban life. These stations should reflect vibrancy, efficiency, and the public ambitions of the city. The intersections between local infrastructure and urban activities, being them bus hubs, metro halls or other nodes of interchange, cannot be conceived any longer as simple services only defined by the complexity of their logistics, but as public living places - moving away from their univocal understanding of step-in / step-out engines. In this sense, it is appropriate to define them as *living stations*. The underground stations of metro urban lines are probably more familiar to the inhabitants of the contemporary urban densities than many well-established public typologies. What different declinations can assume the assignment of the design of living stations as public places in compact configurations?

Of course, the core-business of interurban stations still lays in providing access to an efficient mobility system, in this way facilitating exchanges among the qualities and the opportunities urban areas offer. However, besides the efficiency, the design of interurban stations is in need of stronger elaborations around the key aspects of collectiveness and publicness, in relation to their spatial implications. This is particularly important for dense urban configurations, where the assignment of the urbanization of city infrastructures meets compact spatial solutions to maximize ground exploitation. In this framework, the construction of public identity by place-making approaches expects more from the urban station as a public agent, often asking far-reaching syntheses across artefacts bearing private as well as public relevance. These are *complex projects*,⁸ whose ultimate goals are the co-creation of added urban value in the public ground through creating the conditions for people, places, programs to interact, and identities to develop. Following on Research-through-Design (RTD) experiences⁹ about the convergence between spaces of interurban mobility and public places, the main challenge for the design of living urban stations is to configure them as integral, active part of the public field

of the city, being them (a) hybrid centres of multicultural public life, (b) efficient nodes in the local geographies of qualities and opportunities, or (c) inspiring city-embedded public realms of mass agency.

(a) The synthesis of public gates (interurban stations) and public (cultural) typologies represents a most interesting opportunity for creating vibrant public centres in compact urban configurations, and potentially a successful one. Combining and integrating these different types of public attractors in a hybrid setting can offer advantages for the urbanism of place-making, providing spaces for the convergence of public programs that are relevant to the urban community and that can function 24/7. Cross-overs between the *moving* users of the mobility infrastructures (the public field as transition) and the *staying* visitors of the cultural infrastructures (the public field as permanence) can increase the reciprocal interactions, requiring design solutions that are able to add urban quality to a shared space of mediation among city areas, people, (micro) cultures. Stations on the metro lines and the related mobility programs can merge by design with local cultural institutions like the (branch) library, a small museum, an exhibition hall, workshops and a social centre. By combining these small scale public activators at neighbourhood level, larger public assignments can be developed that hold a higher public significance than the sum of the parts, making possible to mobilize more resources for ambitious architectural projects and for creating identity. (Key aspects: public place; programmatic diversity; creator of urban values; use and re-use of infrastructures; users profiles).

(b) The hybridization of public urban conditions at station locations acquires more complexity in the case of the urban node, when the station is the connector among many different mobility networks and logistic systems in the city. Indeed, taking into considerations new transportation technologies (e.g. smart, flying, self-driving, flexible), raising sustainability

stad). Many new inhabitants are expats, knowledge workers, millennials, urban nomads, attracted by the opportunities offered by the active socio-economic climate of Dutch cities. They are characterized by (inter-)urban mobility and flexibility, their 24/7 life-styles often supported by ICT applications.

⁵ Since its opening in 1968, the metro network of Rotterdam (first in the country) has developed constantly supporting the different phases of city urbanization, and is appreciated for its efficiency (also economical). Rotterdam metro line is still keeping at pace with the city development Rotterdam. New lines are planned for the development to 2040. In Amsterdam, recent developments have seen the realization of the Amsterdam North-South line which is expected to be developed further.

⁶ For a successful compact configuration, efficient connections to other larger urban areas and to nearby smaller cities and towns are fundamental, to relieve the pressure by managing space with time. However, in the national agenda the issue of the quality of these main city gates already resulted in the renewal of many among the major mobility stations in the Netherlands, like in Rotterdam, Breda, Tilburg, The Hague, Delft.

⁷ Here we use the term *station* as a gathering concept for all those places where people can access mobility, from the simple bus-stop to the complex transportation hub. With *small* stations we refer to the *interurban* scale earlier mentioned, targeted on the needs of the specific local area and inhabitants.

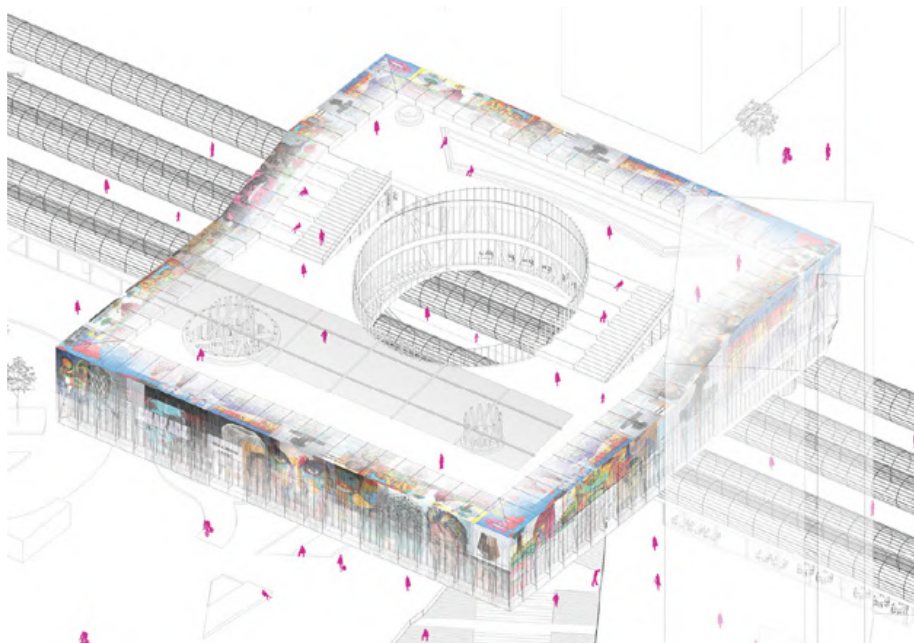

Hybrid centres of multicultural public life. This design combines a Public Library and a Metro Station into one public building at the centre of the neighbourhood.

Sjoerd Boomars, Complex Projects graduation project, 2017, TU Delft

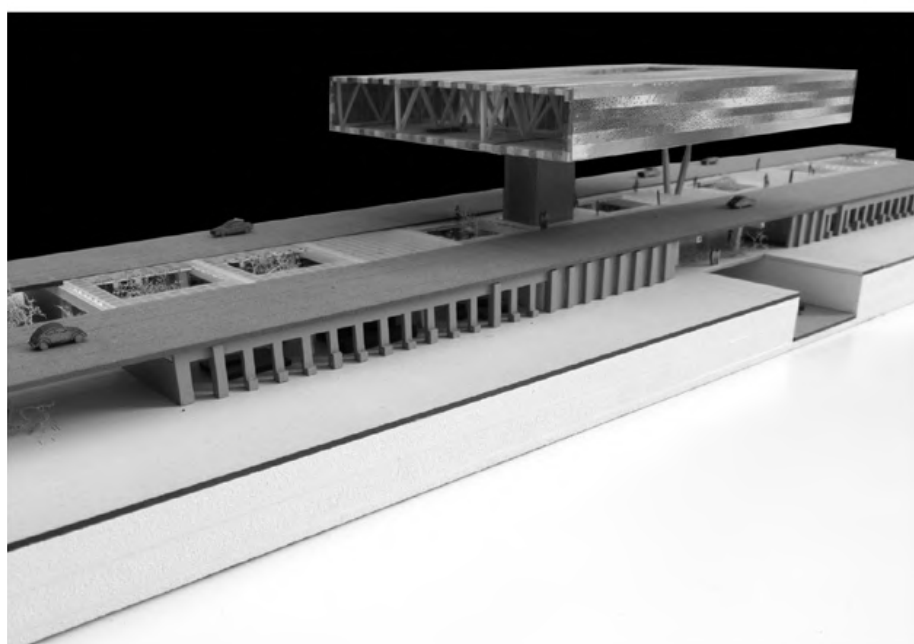

Hybrid centres of multicultural public life. This combination of a Community (Art) Centre, a Museum, and a Metro Station soften the spatial barrier produced by the highway.

Magdalena Nalepa, Explore Lab graduation project, 2017, TU Delft

concerns (e.g. electric, not-polluting, responsible), a changing approach to mobility (e.g. management, information, human centrality), and a new zeitgeist of sharing, customizing, delivering (e.g. multiplicity, hiring, servicing), a large number of combinations exists from which travellers and goods deliverers can possibly choose, and that are better targeted on the particular needs. People can organize their trips *a la carte*, seamlessly combining and managing options and alternatives through dedicated mobility apps¹⁰. The reliability of the travel-time is mostly the leading criteria, but other options can be as well explored. In this changing context, it is useful to exploit as much transportation dimensions as possible, besides the usual ones: air (drones), underground, water; collective and individual; slow and fast; fixed and flexible. On the one hand, these developments multiply the spatial requirements for mobility; on the other hand they enlarge the pool of potential users, consequently increasing the attractiveness of these nodes as locations for work, retail, leisure, culture. This complexity is a design challenge per se, in which the public value of the node acquires a significance at a larger urban scale. (Key aspects: station as node; movement and wayfinding; vertical organization; virtual stations; logistics and people).

(c) The fluxes of masses of travellers and the users of hybrid urban nodes are also significant for conditioning the public realm, simply due to their size. The larger the station / hybrid combination, the more it has a public valence in socio-economic and political sense. However, also smaller stations can be significant for harvesting *big data* or as potential vehicles of political and social communication. The stations, even more when embedded in hybrid syntheses of public and private programs, are the places where large concentrations of people can be physically addressed almost at any time,¹¹ therefore being crucial locations where to compete

for consensus or to influence the urban commons. This 'piggy-back' value not only attracts investments and *regular* urban activities, but also pop-up events, parasite programs, advertising, campaigners, in this way contributing to a vibrant environment and to a more lively public realm, feeding in turn a richer (and hopefully healthier) climate for civic debating. The design assignments of interurban stations should take this aspect in due consideration, recognizing its value and accommodating the field of socio-political and economic communication in the station's spaces, balancing between interior and exterior public spaces and between the digital and the physical. (Key aspects: public place; creator of urban values; movement and wayfinding; virtual stations; users profiles).

What aspects deserve careful consideration when conceiving living stations? The three design assignments and RTD experiences described above illustrate the plurality of variables that plays a role in designing urban stations in contemporary dense cities, and share an understanding of the station as a hybrid artefact. By reflecting on the theme of mobility as significant public realm, place of interaction and (individual, collective) agency, and on its hybridization in collective places by syntheses of public and private programs, a number of aspects comes to the foreground that possibly hold a key meaning for the design of living stations.¹²

1. *The interurban station as public place, integral component of the public space*

This is the basic motif in this article. Stations are familiar places to masses of people, for travelling but also for meeting, acting and for serendipity. They provide hierarchy and orientation. Their experience makes part of the public space of the city, both in its interiors and its exteriors; and both in its formal and informal meaning.

⁸ See Kaan, K. "Complex Projects". In: *Domus*, 992, 2015 (pp. 6-9).

⁹ These RTD experiences are part of educational activities conducted at the Faculty of Architecture and the Built Environment, Department of Architecture. In particular, they have been carried out in the Complex Projects graduation studios Amsterdam 2050 and ExploreLab. In these experiences, a sequence of interconnected steps have been followed and made explicit to inform the design. Also see: Caso, O. & W. Verhoeven. "A strategy for resilience. Alamar, Havana". In: I. Cabrera i Fausto (et al. eds.), *Reactive Proactive Architecture*. Valencia: Editorial Universitat Politècnica de València, 2018 (pp. 182-189).

¹⁰ Like in the MaaS (Mobility as a Service) project, that is developing the integration of various forms of transport services into a single mobility service accessible on demand. These types of services will probably be part of the common mobility behaviour for inhabitants of future urban areas, maybe after a subscription (<https://maas-alliance.eu/>).

¹¹ Also stadia and event locations show similar physical characters of critical mass presence, but hardly 24/7 as in the case by urban stations.

¹² The following ten points have been integrated in a brainstorm with prof. Nacima Baron in preparation of a Dutch-French students' workshop on the design of 'small' stations. See page XY in this book.

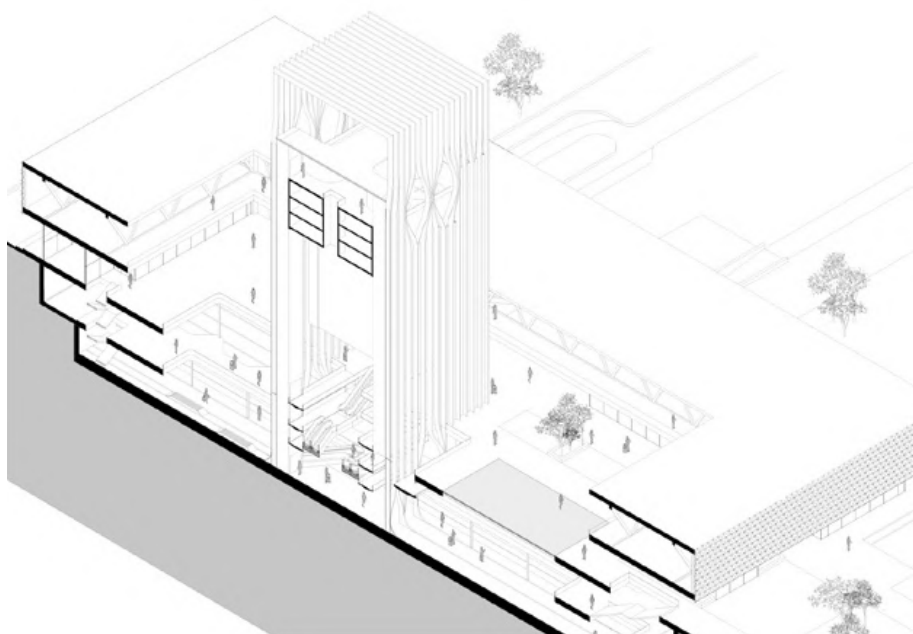

Efficient nodes in the local geographies of qualities and opportunities. This hub connects different public transportation networks (also including water and air) creating an anchor for urban program (public space, retail, office, event spaces).

Cas de Heij, Complex Projects graduation project, 2018, TU Delft

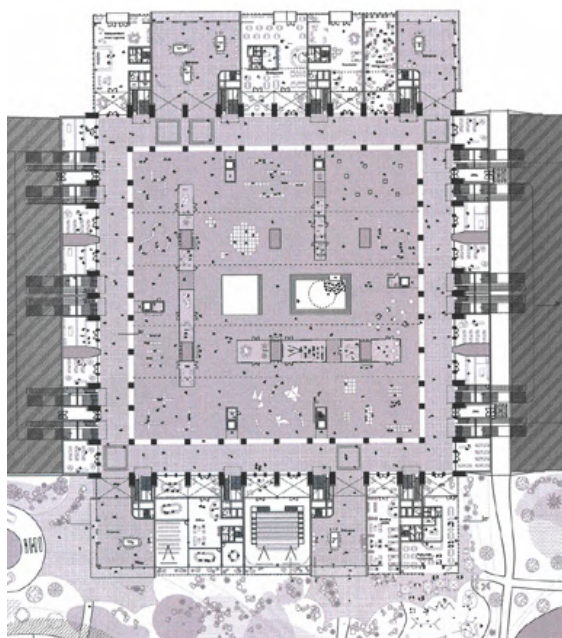

Inspiring city-embedded public realms of mass agency. This intercity station includes trains, metro and busses. It is designed as a public plaza, an environment for civic actions and 'piggy-back' politics.

Roel Schiffer, Complex Projects graduation project, 2018, TU Delft.

2. Station as node in a network

Being part of a networked system, stations cannot be detached from the lines they connect: they bear the expectations of a before and an after, of what precedes and what follows. The relationships between the node and the network are both of logistics and of identity. The convergence of program opportunities and different mobility options informs the node.

3. Station as a creator of urban values

As a public agent, the station contributes to the creation / redefinition of urban values in cities. It creates spatial polarities and sometimes social polarities. Stations are public buildings embedded with public ambitions, places potentially contributing to the shaping of urban commons. For this, their design often deal with cogent socio-spatial issues of common interest, like items related to climate, ecology, sustainability, accessibility, equity, social representation.

4. Use & re-use of infrastructure and stations

Most infrastructural corridors have a history with manifold links to the phases of the urban development. Some old infrastructures turn into new (public) urban artefacts, while others are rediscovered, updated and fertilized with new lines or new types of mobility. Infrastructural heritage offers continuity in time by connecting old and new.

5. Program diversity in stations

A diffused hybridity in programs characterizes many contemporary stations. This includes living, working, recreating, and amenities. This hybridity is connected to the changing modalities of acting in time and space, to emerging life-styles, and to the concentration of travelling masses that make station locations attractive for many users and for investors.

6. Virtual stations

Mobility today knows a strong digital component enabled by ICT applications, both for managing / planning and for gathering big data's. At the same moment, stations are also key places in the daily behaviour of thousands of travellers. Here a mass of people can be reached by information, announcements, campaigns, influencers, pop-ups. The station is thus a potential interface for bearing messages impacting on society, economy, politics. This knows both a physical and virtual side (from graffiti to interactive screens), and reaches outside the walls of the station.

7. Movement and wayfinding in stations

In complex infrastructural hubs, and in particular those with relevant invisible extensions (e.g. underground)

it might be difficult for many to orient themselves, eventually affecting station efficiency and the perception of safety and liveability. Therefore, a good understanding of the factors / devices that positively help orientation and movement is essential. Wayfinding strategies can greatly contribute to liveable designs.

8. Station's users profiles

The traveller / station user is by definition heterogeneous. But in some cases we can observe a predominance of specific typologies of users, maybe because of the social characters of the location or the selective agency of some types of programs. A good understanding of users profiling is essential for conceiving and designing inclusive stations. This also apply to the mobility of goods, as delivery accounts a great deal for travels in urban settings.

9. Vertical organization

Although stations are more and more becoming urban hybrid places, their core-business remains to ensure efficient, safe and reliable access to the mobility networks. For the increasing complexity of growing transportation typologies, an efficient organization of intermodal connections is a crucial factor. In particular, multi-storey stations and stations with a high height difference between city floor and platforms (like underground stations) essentially are vertical organization confronted with issues of vertical connections.

10. The hidden side of stations – people & logistics

Neither all the parts of stations are visible, nor all its users are. Think for instance to the logistics supporting the basic program, the staff, the machinery; or to the use of the station by emarginated people (homeless, junkies), micro-cultures, street artists, or as an event location. Some requirements are invisible and necessary; other uses imply a parasitic relation to the station and its social meaning.

These ten points obviously form a non-exhaustive list of key aspects for conceiving living stations in compact urban configurations. They are deduced from previous RTD experiences pointing out different interpretations of their public relevance, and therefore assignments. This list can help to take into consideration many of the layers that constitute the public fields of action in cities, when mobility is a socio-spatial player. More RTD is needed to enrich the casuistry of city-mobility relationships, for testing the design possibilities of these ten aspects, to gather precedents about their application, and add new items to the list.

Stations as a Lever for Inclusive Growth

Manuela Triggianese

Co-creating inclusive places

While promoting sustainable mobility, stations are considered simultaneously *interchanges* (or nodes) for different types of mobilities (train, bus, tram, car, P&R, taxi, bike and on demand services) and public spaces (or places) for interactions and social networks, where to meet people and to find different urban *amenities*¹. Stations represent a link to both global and local networks (urban, commercial and transport) and therefore they are an integral part of the built environment. They need to be accessible by all and well connected to the entire metropolitan scale. The degree of openness of the station towards the city, its urban permeability, allows for higher quality of life, more social interaction and higher level of inclusiveness. This includes a functional *mixité* in the station area, blurring station limits (physical and social) by promoting the construction of residential and commercial centers around it. The development of *transit-nodes* (or stations) has an impact on the social, economic and security issues with the changes directly involved in the urban fabric, including the railways. By reinforcing the transport network, they have to adapt to mobility transitions associated to those changes. In this context, by looking at the sustainable development goals (SDG) related to the relationship *Mobility & City*, urban transformations driven by the development of transit-nodes comply with the following SDG: *resilient city* towards an inclusive growth² (SDG 11), the *healthy city* towards well-being environment (SDG 3), *booster* for innovation and economy (SDG 9). Based on those considerations, the co-creation experiment presented in this book is looking at existing and new *transit-nodes* along rail-metro networks in the metropolitan area of Rotterdam. By incorporating stations in the city urban strategies, the urban designers, the students and tutors attempt to define stations as *destinations* by themselves and as **inclusive places**, in addition to their travel functions. In the academic

design experiment (City of Innovations project), the potential of using the design as a tool for co-creation is explored. The approach aimed at connecting the mobility strategy with new opportunities for urban growth and neighborhoods related activities, towards an inclusive and sustainable urban environment.

This article attempts to define the paradigms associated to the notion of *inclusive stations* in future metropolitan areas. It explores the challenges on the nodes of the future identified by the Dutch Ministry of Infrastructure and Water Management in the report *Public Transport in 2040 - Outlines of a vision*³ and by the *Grand Paris Express*⁴ project, being used as references by the City of Rotterdam for the proposal of the construction of new circle metro-line and the (re)development of its transit-nodes.

The Public Transport 2040 in the Netherlands

According to the Dutch Ministry of Infrastructure and the Water Management, by 2040 the public transport network will link several urban regions, between the Netherlands' major economic hubs and reaching out across the border, including transport for goods. Demand-driven services and concepts such as car-sharing, bicycle-sharing, scooters and taxis will also evolve, leading to a shift from public and private passenger transport to shared transport, and forming a high-quality addition to the public transport network. The new mobility systems play a major role in the last mile, and in combination with public transport relieve pressure on parking spaces in cities. In 2040 people will travel reliably, safely, rapidly, easily and comfortably from A to B, including people with a disability. Door-to-Door solutions are at the core of governmental agendas and new design scenarios. The research and design experiment by Mecanoo "Journey of the Future" is an example of the new approach.⁵ This research study

¹ The Node-Place model was developed by Luca Bertolini and it was based on TOD (Transit-Oriented Development) theory. For more information about the Node-Place model, please read: Bertolini, L. 1999. Spatial development patterns and public transport: The application of an analytical model in the Netherlands. *Planning Practice and Research*, 14(2):199–210.; Bertolini, L. 2008. Station areas as nodes and places in urban networks: An analytical tool and alternative development strategies. In F. Bruinsma, ed., *Railway development: Impacts on urban dynamics*, pp. 35–57. Heidelberg: Physica- Verlag. For TOD theory, please read Cervero, R. 1998. *The Transit Metropolis: A Global Inquiry*. Washington, D.C.: Island Press.

² See OECD policy framework on the concept of Inclusive Growth: <https://www.oecd.org/inclusive-growth/>

³ See the full document *Public Transport in 2040 - Outlines of a vision for*

the future [13-05-2019] by the Dutch Ministry of Infrastructure and Water Management, available on <https://www.government.nl/topics/mobility-public-transport-and-road-safety/public-transport/the-future-of-public-transport>

⁴ Grand Paris Express, as an automated transit network, is the new metro of the Capital Region. With its 68 new stations and 200 kilometers of additional tracks, Grand Paris Express consists of a ring route around Paris (line 15) and lines connecting developing neighborhoods (lines 16, 17 and 18). More information are available on: <https://www.societedugrandparis.fr/info/grand-paris-express-largest-transport-project-europe-1061>

⁵ Mecanoo, NS Stations (2019) *Journey of the Future*, a passenger's experience, available: <https://www.mecanoo.nl/Projects/project/248/NS-Journey-of-the-Future?d=3&t=0>

focuses on the door-to-door journey from multiple passengers perspectives, exploring how future seamless mobility systems that integrate public, shared and private transport is needed to meet ambitious targets on sustainability, passenger satisfaction and capacity as set out in the government note 'Public Transport 2040.' Here both main (big) stations and smaller transit-nodes are indispensable links in integrated mobility to ensure an optimum journey and seamless travel solutions, creating efficient and attractive multimodal interchange hubs both within and outside urban areas. Apart from various services (e.g. restaurants, shops and parcel pick-up and drop-off points) within the hubs, the immediate vicinity offers opportunities for spatial development (homes, offices and other amenities). The transit-nodes need therefore to be seen in relation to their surroundings and their role in the public space. As links between transport modes, they are also of crucial importance to regional rapid transit. Currently the government is working on the development of the action agenda for Public Transport Nodes in 2021. Together with a large number of stakeholders, an in-depth study has been carried out in the first half of 2020 by mapping 600 (existing and planned) stations within the metropolitan areas of the Netherlands and by setting certain design challenges for each category or type of stations.⁶

In this context, as in other European metropolitan cities like Paris, the major railway stations in the Randstad metropolitan area are under pressure. In order to cope with growing user numbers, a polycentric network of stations of different sizes could be considered, functioning as a system of connected services able to absorb and distribute part of the growth in passenger numbers.⁷ Up to 2030, there is a need for around 240,000 new homes in the southern Randstad conurbation for example, over half of which are going to be built in the central urban area of the metropolitan region. The metropolitan region has the space to accommodate these homes at easily accessible locations along the Rotterdam-Delft-The Hague axis and, therefore, to strengthen the agglomeration force

of the southern Randstad conurbation. The City of Rotterdam itself will grow by around 50,000 residents until the year 2030. There is need for mobility transition to accommodate this change, which includes an increase in the scale of public transport and investment in the infrastructure of the region. A Sustainable Urban Mobility Plan has been developed for the City which focuses on smart mobility (with active modes), zero emission development, modal shift to non-motorized transit, car-sharing, and the expansion of the City Lounge Concept.⁸ The challenges associated to this growth are related to: economy, health, spatial quality and accessibility.

The Rotterdam Mobility Plan lists a number of objectives on the basis of these four perspectives: growth and densification, environment and climate, outdoor space and greenery, and **inclusiveness in mobility**.⁹ To make mobility more inclusive, it is necessary to make daily facilities easily accessible and more pleasant, to make public transport locations more easily and pleasantly accessible, and to realise the increase in the scale of public transport to Zuid. The main urban development ideas of the city approach have been developed by PosadMaxwan¹⁰. Here public transport hubs become more accessible and attractive for pedestrians and cyclists, and a transfer point for car drivers. Furthermore, there are already proposals about a new metro (circle line) connection from Kralingse Zoom via the Feyenoord City development to Zuidplein aiming also for a better connection by metro with the Rotterdam-Den Haag airport. The circle line is presented by the City of Rotterdam and discussed in this book.

The public places 2030 in Le Grand Paris

The mega-initiative "Le Grand Paris" has the ambition to create several economic centers around Paris that are connected with a new public transport (train/metro) network and with the airports and TGV (Train à Grande Vitesse, "high-speed train") stations. Within the scope of this initiative, the "Grand Paris Express" network (GPE) will cover 200km of rail with 100% automated metro

⁶ The categorization of 600 (existing and planned) dutch stations can be found here: <https://design.dat.nl/ov2040/> Date accessed: 21 sep. 2020

⁷ Triggianese, M; Cavallo, R. The station of the future: Amsterdam's stations in transition. In *OverHolland 20*, p. 39-60, nov. 2019. Date accessed: 21 sep. 2020. doi: <https://doi.org/10.7480/overholland.2019.20.4143>.

⁸ The City Lounge is the inner-city development approach since 2008, aiming for an improvement of the quality in the city center. Coolsingel is the starting point of the mobility strategy within this approach, by structurally reducing car traffic from four to three traffic lanes, that will see

around 10,000 fewer cars per day in 2020. In 2015, this traffic accounted for roughly 40% of the total car traffic.

⁹ The Sustainable Urban Mobility plan of the City of Rotterdam is available here: http://tda-mobility.org/wp-content/uploads/2018/11/Rotterdam_Urban-Traffic_Plan.pdf

¹⁰ Healthy, safe and accessible with the Rotterdam Mobility Approach, available: <https://posadmaxwan.nl/en/news/47/healthy-safe-and-accessible-with-the-rotterdam-mobility-approach> Date accessed: 21 sep. 2020

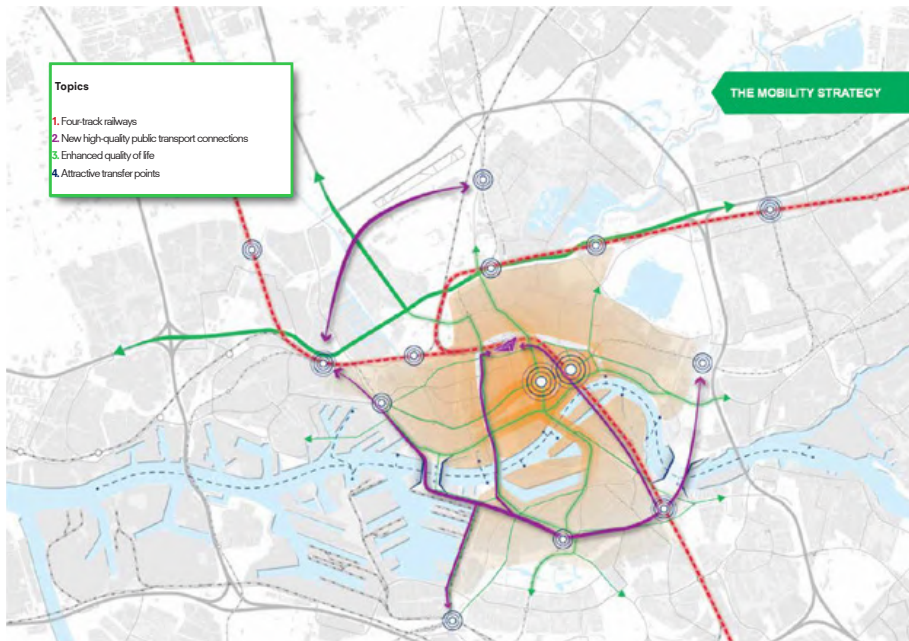

© Rotterdam Mobility strategy. Source: Smart accessibility for a healthy, economically strong and attractive Rotterdam. Rotterdam Urban Traffic Plan 2017 - 2030+ (City of Rotterdam, 2017)



— Gares mises en service entre 2025 et 2030
Source: Calendrier de mise en service de la SGP, cartographie Apur

© APUR, Planning of GPE stations into service between 2025 and 2030. Source: Transformations in Grand Paris Express station neighbourhoods (2019)

system and 68 stations with the aim of providing direct connectivity between suburban districts and improving the connections to the airports. The new interconnected stations will serve 2 million passengers every day with 90% of lines built underground, representing a great opportunity for urban regeneration projects. The 68 GPE stations have very varied geographical, topographical and sociological situations and each have different intermodality issues.

Main ambition for the new transit-nodes are: development of their districts/neighborhoods and better quality of their connections with the **public space**, being the 'sensorial station' (gare sensuelle) the guiding concept adopted by the designers of all stations.¹¹ The public places in Grand Paris play an essential role in the mobility chain. They constitute the joint between the city, the uses and the transport infrastructure. Currently 186 urban projects are underway in the 35 neighbourhoods around Grand Paris Express stations that will be open and running by 2025 (they cover 28% of the surface area of these neighbourhoods). In the next 10 years these projects will provide 84,000 housing units, 2.5 million m² of office space and over 2 million m² of other types of businesses. In 2019, the study conducted by the Paris Urbanism Agency (Apur), describes areas reserved for public space in the future Grand Paris station neighborhoods and underlines the necessity to plan for crossings, places for new mobility services, to reduce car parking facilities, to improve the spatial quality and activate the street levels of the urban surroundings.¹² In 2020 Apur in partnership with the Regional and Interdepartmental Directorate of Infrastructures and Development -DRIEA-, the Grand Paris Express company -SGP-, and accompanied by the public land and development establishments -EPF Ile-de-France- and -Grand Paris Aménagement-, continued the analysis of transformations in Grand Paris Express station neighbourhoods studying those of the 33 stations that will open between 2025 and 2030. From the end of 2015, in partnership with Ile-de-France Mobilités and by associating all the communities concerned, the Société du Grand Paris (SGP) initiated discussions on the development of the areas around the stations of the future metro. This approach resulted

in the launch of a study in March 2017, which led to the drafting of the publication "Places du Grand Paris - Design principles for public spaces of the Grand Paris Express."¹³ The work carried out by TVK agency, representative of a multidisciplinary team made up of experts, professionals of the planning and mobility, represents a guide/common understanding on the role of public spaces at station districts and not as a technical and prescriptive document. The investigation is based on three main ambitions: *continuity, availability and scalability of public spaces*. First of all, *continuity*: the squares of Grand Paris will be an extension of the existing one and will ensure the link between the city and the transport infrastructure. Then, *availability*: it is about creating public spaces accessible to all, bringing together uses and functions. Finally, *scalability* which will allow spaces to be adapted to the city's changes. These three objectives form the basis of a project approach broken down into 40 principles and 15 criteria on: mobility, wayfinding, territory, lightning, landscape, soil, networks, methods, street furniture, uses, water, ecology, materialization, management and construction site. Among others, the principle of *hospitality* is often brought together of **inclusion**, to express the capacity of certain places to welcome those who can be in difficulty in the public space: children, elderly, disabled people, young people - in groups or not -, people migrants, etc. To make a public space hospitable, is to make sure that everyone feels there welcomed and that cohabitation is possible, which goes through care given to equipment, to the seats, to the atmospheres, etc. So while being a part of the metropolitan project what is the Grand Paris Express, the train station and its public spaces are included in a neighborhood or in a development zone, in a living area of the Île-de-France today largely urbanized.

¹¹ Marchetti, P. La Gare Sensuelle In Triggianese, M. et al. Stations as Nodes, 2018. pag 97 <https://books.bk.tudelft.nl/index.php/press/catalog/book/682>

¹² APUR stands for Atelier Parisien d'Urbanisme. Recently APUR has developed an analysis on the transformations in Grand Paris Express station neighbourhoods - The 33 stations to be in service after 2025, available: <https://www.apur.org/en/our-works/transformations-grand-paris-express-station-neighbourhoods-33-stations-be-service-after-2025> Date accessed: 21 sep. 2020

¹³ Société du Grand Paris, Places du Grand Paris. Principes de conception pour les espaces publics (2019), available: https://media-mediathèque.societedugrandparis.fr/pm_1_117_117718-ja409wj20d.pdf . This book is based on a previous study conducted in 2015 by Société du Grand Paris, Les Places du Grand Paris. Repères pour l'aménagement des espaces publics autour des gares du Grand Paris Express. overholland.2019.20.4143.

Societe du Grand Paris, **Places du Grand Paris. Principes de conception pour les espaces publics** (2019), open access publication

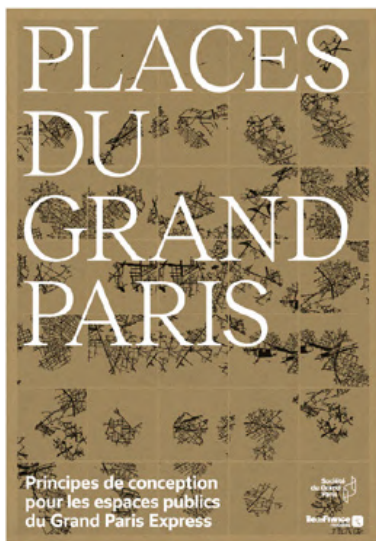

APUR: **Transformations in Grand Paris Express station neighbourhoods** (2019), open access publication



Dutch Ministry of Infrastructure and Water Management. **Public Transport in 2040 - Outlines of a vision for the future** (2018), open access publication



Prorail, **Station Next, HET STATION VAN DE TOEKOMST** (2019), open access publication



Inclusive stations | Paradigms

By analyzing the Dutch and French cases, it becomes apparent that inter-modality, attractiveness and the roles of public space of (existing and planned) transit-stations are crucial when encountering the needs of future generations and of livability and safety in metropolitan area. In both scenarios, by 2040 public transport (PT) will have grown being highly sustainable and well on the way to becoming emission-free. Furthermore, PT aims to relieve pressure on city centers. This will free up space for urban housing development and optimize utilization of the rail network. Especially in peri-urban areas, strengthening public transport connections will help stations to become centers of movement for people, local business and healthy communities, also supporting inclusive growth.¹⁴ The ongoing pandemic of COVID-19 is a strong reminder that urbanization has changed the way that people and communities live, work, and interact, and the need to strengthen systems and local capacities to prevent the spread of infectious diseases is urgent. The role of *stations as nodes*¹⁵ in metropolitan networks becomes even more important in high-traffic spaces by encouraging safer public behaviors in response to pandemic situations (such as covid-19). The urban mobility challenge is to invest in and build strong preparedness systems that are better adapted to increasingly urbanized settings¹⁶. In this context, which spatial paradigms an **Inclusive Station** might respond to future challenges? To cite some: Investing in people and public places by promoting social urban life - travelling seamlessly - urban growth along networks - develop integrally mobility and urban spaces - high connectivity to other urban centers (domestic and international) - resilience (adaptability) with ecosystems and sustainability (nature in combination with technology) - reduction of people flows at peak hours (combination with smart working) - mix of urban functions (hybrid outdoor and indoor spaces) - safety and confidence (proper safety levels for pedestrians and increase the modal share of public transit, which requires high pedestrian service levels at city streets and high accessibility of pedestrian spaces and transfer hubs).

¹⁴ See also 'Tomorrow's Living Station', a report created by Network Rail and Arup, explores and identifies the future role stations will play in our towns and cities: <https://www.arup.com/perspectives/publications/promotional-materials/section/tomorrows-living-station> [accessed on 01 September 2020]

¹⁵ See also 'Stations as Nodes' publication [eds.Triggianese M. et al., TU Open 2018] <https://books.bk.tudelft.nl/index.php/press/catalog/book/682>

¹⁶ Epidemic preparedness in urban settings: new challenges and opportunities [Published Online March 27, 2020 [https://doi.org/10.1016/S1473-3099\(20\)30249-8](https://doi.org/10.1016/S1473-3099(20)30249-8)]

The Art of Designing Infrastructure

Marc Verheijen

The art of designing infrastructure

Infrastructure is designed. Infrastructure is man-made; it is devised, made and maintained by people. For a city as Rotterdam to properly function, many types of infrastructure are needed. From sewers to rails, from fibre optic cables to underground railway tunnels and metro stations. The city is based on a 'spaghetti' of pipes, tunnels, cables, routes and wires. The crossings and knots are the connecting points for exchange. The physical infrastructure we all use, often without giving it a second thought, is purposefully designed. The right approach to design of these kind of infrastructures is not to see infrastructure as only a facilitator of mobility, but as a possibility to create value in sociological, cultural, ecological and economic ways as well. This is an integral way of designing infrastructure. This is infrastructure, and the people designing in this way are the so-called infratects. It is important to stop approaching the design of infrastructure as a solitary project and we start seeing it as an integral, inextricable part of our everyday environment. By closely working together with professionals from other disciplines we can profit so much more from our investments in infrastructure. In this way, we can create possibilities that contribute to a sustainable society for this generation and those of the future. Infratects know the art of integral design of our dynamic society, of the spaces in which we meet, in which we are, in which we move.

Special phenomenon

Moving is essential to people, for their reproduction, trade, development, social exchanges et cetera. The places where we live have usually originated at crossings of trade routes over water and over land, at mountain passes, around train stations, at fords or in deltas. Most of them natural or created meeting places, where it was relatively easy to travel or where different routes converged. Our mobility these days is extensive, and in order to be this mobile, we use many different infrastructures on a daily basis. We have a historically grown system of networks at our disposal. Our society is based on these global systems and networks of infrastructure. Universal and generic in one respect, local and specific in another. By car, you can get to almost every address in the world. By train, you can travel from station to station quickly and comfortably. The strategic positioning of airports allows us to travel to a different continent in a matter of hours.

Infrastructure is a given part of our everyday environment. It is the physical basis of modern societies, the foundation on which we travel, meet each other, make exchanges and have new experiences. Infrastructure is experienced and used. In the eighteenth century, Immanuel Kant used the term phenomena for 'appearances people cannot know the true nature of, but can only experience'. Infrastructure is a special phenomenon. All of us use multiple parts of our extensive infrastructure network every day, but hardly any of us know who actually owns this infrastructure, who maintains it, who finances it, who designs it, who makes decisions about it. Still, infrastructure has indeed been devised by the human brain, and has been realized by people, spending a lot of money and energy in doing so. Every part, every extension and every adjustment has been devised, designed, planned and made. The true nature of it, however, is rarely scrutinized.

Designing infrastructure is an activity that takes place in the wings of our society, but it has a structural and fundamental impact on the conditions in which we live. In London, for example, five billion pounds were invested in the renovation of the existing underground railway network in the build-up to the Olympics. Countries such as Germany and France spend over sixteen billion euros a year on the construction and maintenance of their national infrastructure. The Øresundsbron, connecting Denmark and Sweden, cost over four billion euros to build. Worldwide yearly investments in infrastructure concern sums of money most of us cannot even fathom. Besides money, we as a society spend much energy and manpower on infrastructure. Hundreds of thousands of people across the globe work in the world of infrastructure. Most of their work is about making sure existing infrastructure functions well every day. Think of road works, but also of traffic control and snowploughs, et cetera. Only a small percentage of these people work on the realization of new infrastructure, such as contractors, civil engineers and railway companies. An even smaller percentage of all people working in the world of infrastructure devise and design infrastructure. So a small, select group of civil engineers, architects, landscape architects, urban designers and traffic engineers determine what our infrastructure looks like, the infrastructure forming the foundation beneath our society, the infrastructure creating the conditions for our society to evolve. Specialists capable of designing new infrastructures or adapting existing infrastructures to new demands and requirements, based on research, analysis, creativity and level-headed thinking.

Black Box

Volumes have been written about what design is, how it is done, what steps have to be followed. There is, however, no clear, universal definition or view. To outsiders, design might well seem like a black box. And perhaps it is. Many designers know what it is, but they would be hard-pressed to come up with a precise formulation. A proposed definition would be: there is a problem, a completely unclear jumble of desires, demands and constraints, and not before long a team of creative people has come up with a solution. To design is to develop a proposition in answer to an existing question. This is no different for infrastructure than it is for urban design, architecture or landscape architecture. All of these involve spatial designs: a three-dimensional proposition within an existing context. Even a road, no matter how flat, has to be thought up in three dimensions. Even a road creates and shapes space. And since a road has to function for a long time, the factor time, the fourth dimension, also plays an important role in the design process of infrastructure.

Larger, Societal Problems

Designing can be as simple as that. There is a question, and a designer then comes up with an answer in the form of a sketched picture of the future. Sometimes we have to simplify complex problems to come up with a solution. But is that it? Limiting the answer to a satisfactory result for the designer and the client might suffice for the short term, but from a sustainability perspective, we would not be making the most of our chances. For behind a concrete question, there is often a larger, societal problem. A typical infrastructural project is about a road from A to B, but the reason for the project can generally be traced back to social needs and developments in planning. By separating infrastructure from other developments and needs in society, designers can come up with concrete results quickly. This forced, artificial intervention seems to meet the current needs, and we can move on. But for how long? In my opinion, this is not the right attitude. For in reality, the question is so much more complex, requiring more attention, expertise and energy. Global developments with an influence on the local level, such as urban growth and rural depopulation, change mobility patterns. Cities become 'more crowded', streets become busier. It becomes increasingly difficult to find a parking space. Cyclists have to pay more attention and drivers have no choice but to be patient. These are gradual transitions. They seem to evolve without a system or deeper logic behind them. So preceding an actual design, there is often a process of years, if not decades, in which diverging demands,

expectations and even desires come together. Designing therefore starts at a much earlier point than the project assignment itself. To be able to design alternatives for a future as yet unknown, it is essential to understand these developments. To observe underlying processes, to experience these, and to use these experiences. That is what infratecture should aim for.

Embracing Complexity

We have to translate our economic, cultural, ecological and societal issues into concrete design questions. Our current demands, expectations and desires should become a part of the design brief in addition to the more traditional parts such as specifications, terms, norms, requirements, guidelines, support, financing, and decision-making processes. Why not add a chapter of 'desires' to these design briefs? A project for a road from A to B will thus have a much broader effect on society. It will not only create a solution for a traffic-related problem but will also stimulate developments in other domains. To realize this added social value, infratecture should not be daunted by diverse and partly even opposite goals, ambitions and demands. Instead, they should embrace the complexity of their task, and they should be able to translate this demanding package into an understandable and attractive perspective.

Open-minded attitude

Infratecture is an invitation to think in possibilities, rather than in solutions. Designing can then be much more about exploring possible alternatives for the future. Designers are required to have a flexible attitude and to keep their options open for as long as possible. Early choices for a certain direction based on first insights and ideas will speed up the design process but carries the risk of depriving many qualities of the chance of being discovered. Thinking a direction through leads to new insights and knowledge, which may well lead to different choices, or even different directions. The design process should therefore not be considered as a linear, but as a cyclic process. A cyclic process provides room for the re-evaluation of design directions after deep assessments have been made, and for new choices based on this knowledge. And that is the essence of design: choices. More than anything, to design is to make choices. This might seem to contradict the ambition to keep our options open, but merely keeping options open will not change the infrastructure. For in the design process, design decisions will have to be made (choices) to eventually come to designs that can be realized. Infratecture stands for making choices leading to an integral design with added value for society. The key is the cyclic



www.schepenstraat.info



www.rotterdam.nl/wonen-leven/H6weg/

design process in which considerations and choices must be made based on knowledge and insights obtained on various scale levels. This cyclic thinking is characteristic for designers, and it sets them apart from many technicians and specialists. At some points, designers keep working on a specific part of a larger assignment, while at other points they will focus on the overall picture. One of the most important qualities of an infratect is the ability to think on different scales. Projects often take a long time, are complex in many ways and cross several borders, including administrative ones, especially in infrastructure. By not immediately choosing one direction, but keeping an open mind and thinking in possibilities, the infratect is able to discover new qualities, engage in meaningful relations and join forces with others to eventually choose the direction that will add social value to the infrastructure.

Finesse

This way of designing requires courage. For when you get to this level of thinking, you risk losing your way completely. In S,M,L,XL Rem Koolhaas said 'you can get completely daunted by the task...' Staying on course with so many variables, expectations, interests and requirements is not easy. Knowing when enough is enough. At what point do you have to make choices and present these to the stakeholders? This requires finesse, intuition and experience. This complexity also requires interdisciplinarity. The problems we face require the expertise of people from various disciplines: not only spatial design disciplines such as traffic engineering, civil engineering, geo-technology and construction, but also planning, economy, sociology and other disciplines. It is clear that positioning infrastructural questions and approaching these as social matters is no sinecure. To make matters even more complex, the designer also has to enter into dialogue with interest groups, residents, users, investors, administrators and other stakeholders. Social positioning of infrastructural questions means designers also have to define their position in the social debate; it means they have to admit irrationality and emotion. The Channel Tunnel between the United Kingdom and France is obviously an object made of concrete and steel. But the historical, cultural and emotional impact of this tunnel on the regions it connected is enormous. Besides the functional requirements, these factors also played an important role in the design process. And rightly so, because this new connection also meant new positions within Europe for the regions on either end of the tunnel.

Creating conditions

Infratecture is the insight that with the realization of an infrastructure project one can achieve more than just a solution to a specific functional problem. With infrastructure, we create the conditions for our way of life, including all potentially positive and negative aspects. Approached in this way, infrastructure is the development of a realizable (administratively, financially, spatially and functionally) proposal that naturally also meets the design brief. The extra quality infratecture adds, is that the result creates social value. Value beyond the functional. Value beyond the design briefs, even value beyond the level of expectations of the stakeholders. Good infrastructure has current value as well as future value. Infratecture answers current questions creates conditions for future developments and for yet unforeseeable development and is a plea for embracing. Or: infratecture means looking at a problem from different perspectives, getting to the bottom of it, and striving for a comprehensive approach, analysis and design. It stands for the development of solutions from which nothing is missing. For constant changes of perspective enabling a complete study of the problem and the inclusion of all interests and aspects. Integral means observing, understanding and positioning those relational aspects leading to a successful and meaningful solution. Infratecture is the art of designing, shaping and giving meaning to the foundation our society rests upon. The foundation that allows society to function optimally in all its dimensions: spatial, social, cultural and economic. Infratecture is not a new or autonomous discipline. Infratecture is an attitude, a mentality, a way of thinking all designers, planners, managers, clients, project managers, administrators and other people involved in planning can familiarize themselves with. The step from for instance civil engineer, traffic engineer, landscape architect or urban planner to infratect doesn't necessarily have to be big or complicated, but it does require an essentially different attitude and is the deciding factor for the eventual result. It means being a master in your own field as well as truly understanding the other disciplines. Only by looking beyond the functional perspective are infratectes able to cooperatively create added social value with infrastructural projects. Added value not as a coincidental bonus, but as a goal to purposefully strive for. This makes devising and realizing infrastructure a design question of great importance and relevance: an 'art' that takes infrastructural projects to a higher level in an increasingly complex world, with ever more crowded cities, with limited space, with shrinking budgets, and increasingly more vocal citizens



Beeldbank Rotterdam:
bicycle facility Blaak:



Beeldbank Rotterdam:
Zuidplein

Railway Station Projects in Greater Paris

Nacima Baron

This article concerns the projects to renovate and modernise railway stations in the outer metropolitan area of Paris. These projects correspond to the objectives of the metropolitan authorities: optimised mobility and the emergence of a more polycentric conurbation. However, their roll-out is being hindered by a lack of identification with, and democratic debate around, the issues that these projects raise at local level.

Introduction

The railway stations in the outer metropolitan areas are central to the challenges of metropolitan planning in the Greater Paris project. Over the next ten years, according to the current planning documents (SDRIF 2013, PDUIF 2017) the Greater Paris Express network will reinforce the multi-polar structure of the conurbation. The stations in the outer metropolitan area will be situated in neighbourhoods with a mix of housing and local services. They will be more multi-modal than they are today. They will accompany the emergence of communities in the outer suburbs where urban development has remained diffuse hitherto. Thanks to these railway lines that are currently being renovated, these small stations will connect the residential outer suburbs with the new business quarters in the west and north of Paris, but also the small business centres that are expected to grow up around the Greater Paris Express stations.

This process is driving renewed interest in these small stations and railway stops (i.e. stations where the passenger building is closed, but the train still stops and the platform is in use). These points on the regional rail network belong to the Departments of Seine-et-Marne, Yvelines and Val d'Oise. They are situated approximately between 40 and 80 km from the capital, or about 25 to 60 minutes from Paris by train. These stations are attached to small towns which are marked by a diverse range of socio-economic trajectories: small industrial towns suffering from degrowth and with poor populations, "dormitory suburbs" housing office workers, and leafy villages re-invaded by a management class fleeing Paris. There is a strong contrast between the very prosaic reality of these stations, the very limited nature of the services they offer today (obsolescent buildings, lack of shops around them, low commitment of the bus transport operators that serve them, anarchic parking of large numbers of cars all around) and the discourse around them. Understanding what is at stake with these small stations therefore requires the functional object (the building) to be separated from the project it represents. This article is about how the "small

railway station in the outer metropolitan area" object constitutes a subject for public policy, that is to say a means to achieve various objectives. By understanding the different perspectives of the dominant actors, the local stakeholders and different social groups, it will be possible to highlight some of the reasons for the difficulties encountered in implementing these projects.

The small railway stations in the outer suburbs carry in them a series of historical legacies, whilst also marking a new era in the development of the outer metropolitan area

This part explains that small stations represent a certain segment in the rail offer, but also in the accessibility offer to and from Paris. In the past, these infrastructures have been marked by several cycles of investment that have sometimes enriched them, but at other times have impoverished them by depriving them of some of their technical functions, limiting their capacity to fulfil what could be their role in the local territory.

In what way are these railway stations "small"?

The railway stations of the outer suburbs are "small" in three ways.

- Firstly, they represent a small, but non-negligible segment of the rail offer and passenger traffic. Two thirds of the railway stations in Ile-de-France see fewer than 5,000 passengers a day, 20% of them fewer than 250 and there are even 6% (i.e. 22 stations) that have fewer than 50 passengers a day.

- Then, they are small from the point of view of the land occupied by the building and other spaces. These are often small buildings with a second floor (containing a flat for the station master), with a canopy over the platform to protect the passengers, plus a few technical buildings. Stations that previously had a goods traffic function may cover a larger area and have more buildings (maintenance, storage of goods such as grain, for the Ile de France is a major cereals producing area). These stations are nevertheless restricted in size, offering passengers the minimum service that a rail transport operator can offer: a few seats, a ticket machine and sometimes a hot drinks vending machine. Certain buildings are closed and the seats and ticket machines are on a platform directly accessible from the outside.

- Finally, the small stations serve small towns (generally with populations of 4,000 to 10,000) and are sometimes equidistant between two of these towns and in a loosely urbanised area.

A new cycle of investment

Small railway stations have been the focus of three railway investment cycles.

- The first corresponds to the era when they were built, during the Second Empire (1850-1870). At that time they were stops on the main lines (Paris-Marseille, Paris-Strasbourg, etc.). They were built in series, with a recognisable style and care in the ornamentation, for they were conveying the image of the big companies. Other, more modest stations were built at the end of the 19th century by the departmental companies for more local traffic. The electrification of the main lines (no more need for technical stops to pick up coal and water for the locomotives), the advent of the truck and the rural exodus led to the elimination of a large number of these stations in the Ile-de-France area in the 20th century.

- A second cycle of modernisation occurred between 1970 and 1990, when the national railway company SNCF was trying to keep up with substantial growth in suburban traffic and in the economies of small towns in Ile-de-France, some of which were industrialising. These small stations were designed as circulatory systems for a population of hurried commuters. They were given subways (to cross the tracks safely), rows of turnstiles (the season ticket became the norm), outdoor car parks (ordering of vehicle flows at a time when car ownership was becoming accessible to the middle classes). On the other hand, the elements relating to contacts with the customers (ticket offices) and their comfort (waiting rooms) were eliminated. It was at this time that the passenger building was sometimes closed for good.

- Finally, a third cycle of investment began at the beginning of the 2010s, under the impetus of the national railway company ("augmented railway station", Proximus, "shared station", etc.) and the Ile-de-France regional transport authority (multimodal exchanges, park and ride schemes, etc.).

Three actions have been implemented:

- a project focused on transport and mobility: its aim is to increase multimodality and accessibility so that the railway station becomes a multimodal hub;
- a programme centred on services to passengers (here there is a change from a strictly technical approach, as in the 1980s the approach was centred on the needs of a customer on the move);
- the integration of the station renovation (building and land occupied) into an urban planning project district around the station therefore the local area. Generally,

the small station retains its existing form, with little being destroyed and few new buildings, but this heritage is entirely reintegrated into a pitch that emphasises the arrival of a new railway, institutional and urban context.

Arguments for and content of the transformation projects concerning small stations in the outer metropolitan area

This part lists the factors that explain the focus of a series of actors (public and private, railway, institutional and real estate) around the small stations object, and lists the types of ways in which the operations are changing the small railway station.

The dominant arguments to justify the intervention on small railway stations are of five types.

- A national obligation: the energy transition
Energy and ecological transition policy seeks to limit the emissions of greenhouse gases and support a policy of encouraging soft forms of mobility and the use of public transport. The 2019 Framework Law on Mobility has two main goals, in which these small stations can exert some leverage: to invest more and better in everyday transport, to facilitate and encourage the deployment of new solutions to enable everyone to travel and to commence the transition towards cleaner mobility.

- An operational argument and a technical necessity.
Regional rail traffic saw two-figure growth through the 2000s, for structural reasons (the peri-urbanisation wave) and for cyclical reasons (peaking car fuel costs drove commuters onto the train). These railway stations therefore need to be expanded to cope with the larger flows of passengers at peak times. In addition, the Brétigny derailment (8 dead in 2013) turned the spotlight on chronic under-investment in the maintenance of suburban railway lines. At the time, the national railway company's investment effort was focused on the high-speed lines. Reinvesting in small stations is a way for the national company to act on two levels: (1) to show that it is making up for lost time on the Greater Paris rail network, (2) to upgrade the stations in terms of comfort as, during the works, trains are delayed and commuters dissatisfied.

- An institutional negotiation: Greater Paris against its outskirts.

The Greater Paris project is investing more than €40 billion and radically transforming the departments that make up the inner suburbs (petite couronne) (Seine-Saint-Denis, Val de Marne, Hauts de Seine). The

local authorities in the outer ring of suburbs (*grande couronne*) (Seine-et-Marne, Yvelines and Val d'Oise) are contributing on a massive scale to the investment effort through taxation. Revamping the smaller railway stations is a response to the feeling of injustice expressed by local inhabitants and politicians, in the face of the concentration of wealth in the centre of the metropolitan area. The work on the smaller stations will help to develop business in the construction/public works sector and to draw property developers towards the small towns instead of the central area of the Paris conurbation.

- Stations for those banished to the suburbs versus stations in the happy fringes of Ile-de-France
From the Yellow Vests movement to the COVID lockdown, the rural outskirts of the capital region have been shown by the media in contradictory lights. In 2018 and 2019, this region was a hot spot of the Yellow Vests movement, a middle and working class revolt that followed the reduction of the speed limit on non-motorway roads and the introduction of a fuel tax. This period revealed the car-dependence of the inhabitants of these peripheral zones and highlighted their loss of status (or fear of seeing their status downgraded), their lifestyle centred on the individual house, and their residential trajectories (these social strata having partly left the inner suburbs as they rejected the level of residential density and ethnic mix of the suburbs closer to Paris). At this time, the railway stations in the outer metropolitan areas were seen as precious objects allowing these populations to access the capital's resources for the long term.

The lockdown of spring 2020 threw a different type of light on them. Suddenly 20% of Paris's population headed out of the city, many of them moving to second homes in these peripheral areas. Those without second homes are focused on the better housing conditions (private gardens, spacious houses instead of tiny flats). The outer metropolitan area has come to be seen as a less dense, greener and healthier urban environment, with the lower density seeming to facilitate social distancing and the management of the pandemic. The post-lockdown period is seeing an effect on house prices in the small towns in the outer metropolitan area which have railway stations. Values of houses that are within a reasonable distance of the station have gone up even more. These outlying railway stations seem to have become a potential instrument of speculation and spatial classification in the outer metropolitan area.

- Railways stations ready for the opening up of the railway network to competition:

Responsibility for the small railway stations lies with a dedicated branch (Gares&Connexions) of the railway network operator (SNCF Réseau). Responsibility for mobility around the small stations lies with a regional operator (Ile de France Mobilité), whose president is also president of the Regional Council. Responsibility for other issues around the station lies with local institutions (station planning with the inter-municipal authority, urban projects supported by the municipalities themselves). The funding sources available to revamp small railway stations are limited, given the enormous effort currently being put into modernising the lines by the public actors. Small stations are a heavy burden in the operation of the network and bring in little revenue (used by few passengers compared to the huge numbers using the stations in the centre of the conurbation). The issue is therefore the following: how can these stations be redefined so that they generate some value again, and how can that value be shared in a context where there is no dedicated investor or stable business model, but only a degree of potential and some pressing expectations.

This question now takes on a particular significance as, over the next two years or so, the regional railway business will start to be progressively opened up to competition. The railway reform takes account of this new context and lays down 3 public service missions for railway stations: (1) that they accommodate the trains of all the operators and guarantee equal treatment between them, (2) that they accommodate all transport solutions in the stations to become hubs where different mobility solutions are truly integrated, (3) that they enhance the role of stations in urban and territorial development. The opening up to competition is a threat to the monopolistic national company. Its treatment of the small railway stations is therefore a way of preparing for the arrival of competition. For the historic rail company this means acting positively and pro-actively so that it can retain its market share, as its brand image has recently been dented by long strikes. The solution found so far is this: the historic operator, wishing to work more closely with the local actors who hold the future of the rail company in their hands (through the regional transport body), has called for a pact with the local public authorities in the outer metropolitan area, with a view to developing renovation projects for small railway stations, which will involve a joint financial effort on the part of the rail company and the local authority. This pact was launched in December 2019 in the Senate, the emblematic centre of local power, and concerns three types of transformation for small stations.

Work gets underway on the small stations: three types of transformation

The first type corresponds to functional optimisation and involves creating a multimodal hub. The architecture of the passenger building is unaffected, but it will be adapted to a door-to-door mobility chain. The additions are modular and incremental: expanded car parks with electric vehicle charging stations and dedicated car share spaces, improved pedestrian pathways between the station and bus stops, bike parking facilities, etc.). The inauguration of these exchanges gives the impression of a great leap forward, but in fact these projects evolve incrementally and there is no change to the site's function: it remains dedicated to mobility. The second type corresponds to a transformational adaptation. Small stations undergo adjustments to the space they occupy and their buildings and see their uses diversified. The aim is not only to move passengers, but to create value by concentrating different activities in the station. For example, the railway company rents out unoccupied spaces to shops or to public organisations. Such projects may be interlinked with parallel re-urbanisation programmes concerning the area surrounding the station, which can lead to reciprocal knock-on effects, but these are not yet radical changes. The third type corresponds to a radical transformation: as well as radical changes to the land occupancy and buildings, there is also an institutional reorganisation between the stakeholders. For example the station is sold, a new development plan alters the land uses and the legal basis of the value distribution. Housing programmes and the creation of services lead to a metamorphosis of the neighbourhood over periods of decades and across tens of hectares.

Territorialisation of railway station projects: political appropriation and social diversions

This section looks at how railway station projects are perceived locally and how this reflects a considerable power imbalance between different stakeholders. The ability to intervene on railway infrastructure is concentrated in the hands of the Regional Council, the regional mobility operator and the network operator and administrator. Except in the third type of case, they are responsible for planning and steering the project, and possess the financial instruments and the first-hand access to information, including in particular the trends in land values near the stations. The local side of the circle of stakeholders consists of small and scattered partners (elected representatives of small municipalities and inter-municipal bodies, a variety of developers, including small firms). The dominant actors propose

the small station projects to the local stakeholders, but the latter may be sensitive to varying degrees to such projects, as well having a limited capacity to intervene and in some cases a hazy idea of the implications of the station project. We will present the points that tend to be opaque and ambiguous in the pitch and schemes that accompany these projects, viewed from the local level.

The railway station project as an uncertain combination of a technical programme and a plan for the public good

The railway station projects undertaken in the 2000s and 2010s are surprisingly similar across the whole of the Ile-de-France region. This resemblance is in some ways due to the architectural homogeneity of these stations, which we have already mentioned and which is a historical fact of life. But it is also due to the series production of the railway station projects themselves: the regional transport authority has its programmes, while the railway company works on groups of stations radial train line by radial train line, and so on. And the diagnoses, like the solutions, work to a set framework: dimensioning of peak passenger capacity using an equation based on the number of services, the size of the transformable spaces and the budget available. Another professional practice that adds to the number of elements framing station projects is the method of defining the pedestrian feeder area around the station, a sort of magic circle where soft modes of mobility are meant to be promoted. This zoning is done by using a compass to draw a circle with an 800-metre radius around the station, equivalent to an average walk of 10 minutes. Finally, the planning doctrines that underpin these projects are all based on identical ideas: densification and intensification, assertion of the centrality of the station district - all terms that are conjugated with positive representations of how the railway station can bring new life to this part of the town or village. The fact that the populations of these outer metropolitan areas may have different understandings of the terms used to those of the experts does not seem to have been anticipated. The railway station project arrives in the town presented as a solid technical programme, but may well be incompatible with the expression of what the station is, seen from the point of view of the local area and society: a focal centre or wasteland, a zone full of life or one subject to lawlessness, etc. This may explain why certain types of project (especially "shared" railway stations where



- | | |
|---|--|
| 1. Kiosque à café | 7. Garage à vélos |
| 2. Paniers de fruits et légumes | 8. Toilettes |
| 3. Consignes pour retrait de colis | 9. Accessibilité handicapés (rampes, ascenseur sur les quais) |
| 4. Espaces de coworking | 10. Abris sur les quais |
| 5. Micro-crèche | |
| 6. Parking relais | |

1. Coffee stand
2. Fruit and vegetable baskets
3. Parcel lockers
4. Co-working spaces
5. Micro-crèche
6. P+R
7. Bike garage
8. Toilets
9. Disabled access (ramps, lift to platform)
10. Platform shelters

Figure 1. A small station "augmented" with modules: a transformation of the station's functions with a marginal effect on existing buildings (Source: Le Parisien)

LP/INFOGRAPHIE : ANAÏS RENAUD.

the invitation for tenders includes coworking spaces) frequently fail even though there is demand on the ground and motivated leaders may be involved. The feedback in these cases shows that the parameters (location, ergonomics of the premises proposed, evaluation of the number and profile of potential users, expectations) are decided and managed by the railway institution, with an institutional framework and regulatory constraints that are difficult to accommodate in a more open and pragmatic context of local management.

Railway station projects in the local power jungle

Who is responsible for steering the station project in the greater metropolitan area? It may be the inter-municipal body. French law confers upon inter-municipal bodies, with some differences in level depending on whether they are “communautés de communes” or “agglomérations”, four areas of competence: mobility, territorial development, economic development and the environment. In this case, the inter-municipal body also finds a tool for asserting itself in relation to the other infra-regional institutions. It is a known fact that the Ile-de-France inter-municipal structures came much later and were much more difficult to set up than in the rest of France, but they were finally forced into existence by the Prefects towards the end of 2016. At the time, the attitude of the State was quite prescriptive: the railway station must serve as a starting point around which small towns are grouped. Thus, the inter-municipal body is often looking to consolidate its scope and generate solidarity between the municipalities involved through operational mobility contracts applicable across the de facto communities, which may or not correspond exactly to the official inter-municipal scope. A crucial fact is that the inter-municipal body does not work on railway lines but on groups of stations, which may belong to more than one radial railway line. Thus, the inter-municipal body shapes the usual services (bus) or experimental services (on-demand shuttles) together and invests in soft infrastructure to boost the emergence of a small territorial system, which seeks to achieve, eventually, a balance between housing and jobs, in other words to limit the pull of the centre of the Paris conurbation.

For the mayor of a small municipality in the outer metropolitan area, the railway station is an object over which he or she has little control. For these mayors, the SNCF is a remote public enterprise with a complex organisation. In fact the local station, for the mayor, raises issues connected to other objects of public action. For example, it will be come up in discussions of parking in neighbourhood council meetings (the cars of inhabitants from neighbouring towns or villages, on

top of local residents’ cars, clog up the areas around the station). It can also come up in what can be emotive discussions of local petty delinquency. It goes without saying that the mayor will have a vision for his or her town which involves the long-term plans for the station, which are produced by the Regional Council or the inter-municipal body, but his or her spheres of action are peripheral to the station both spatially and functionally: they essentially relate to the roads and the urban land use plan. The mayor is the elected representative most directly exposed to a whole series of tensions. There are the classic difficulties of local governance, the balancing act between day-to-day concerns and monitoring one or more railway station projects (for example a multi-modal exchange project, a service project or a housing programme), which all have different time-frames and involve different stakeholders. In addition, there is the constraint of turning - or rather adapting - technically strictly circumscribed projects into local projects whilst integrating the orientations of a whole chain of overarching institutions and giving voice to the expectations of the town’s own citizens.

Everyone in the peri-urban area has their own idea of a plan for their station: the one that best matches their lifestyle

For a working couple living in the outer suburbs of Paris, the railway station is a way of articulating day-to-day mobility (the ability to work far from home) with residential mobility (the possibility of choosing a place to live based on housing prices, amenities, and also, more and more often, a desire to live alongside a population like themselves). The railway station draws two types of populations.

- Certain inhabitants live within walking and cycling distance of the small station, in a spacious, leafy neighbourhood. This is not down to chance. Mainly members of the higher classes, they work in Paris, which is why they can afford to buy a house in the “golden triangle” of the village. During lockdown, they were easily able to work from home, since they were already familiar with this practice. Some of them also keep a small flat in Paris as daily travel times are long. They also have their doctors, friends, the higher education institutions of their children etc. in Paris. What they want from the future operators selected in the tender process is a direct, frequent express service from their station, a sort of express shuttle between this small station and Paris. The multimodal exchange is of no particular interest to them, apart from the bike park, as it would impinge upon or complicate their daily journey. Other inhabitants, locals or those from the rest of the inter-

Figure 2. Four years of calls for projects (Shared Stations Programme) to diversify railway station uses and services
Source: SNCF Transilien

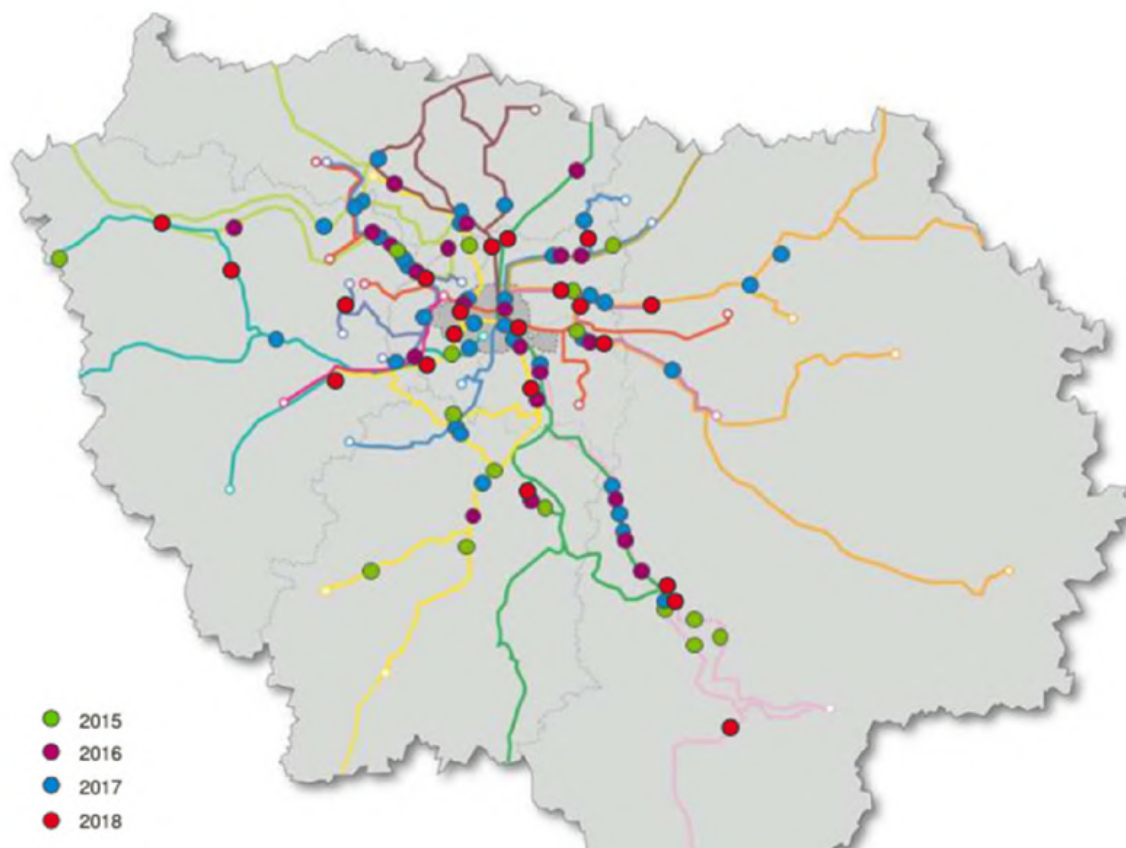

municipal area, who clog up the roadsides with their cars squatting the same place all day long, are seen as the enemy. The plan for services in the station may interest them, especially drive-type services or lockers (parcel collection), but certainly not a third space for teleworking. Plans to increase urban density by filling in urban infill sites in the station quarter offend them, hence their interest in advocating the political values of proximity and ecology (some of them even propose making the quarter a car-free enclave) to hamper this densification and mixed character of what is a sort of Parisian residential colony.

- Other inhabitants live within driving or public transport distance of the small railway station and use it to get to a job in Paris, or sometimes somewhere nearer when they can find a job in one of the secondary central points that are developing and becoming more autonomous within the wider urban area around Paris. This is a population that is in the process of becoming anchored in the community developing at inter-municipal level. These two features, the combination of car and rail mobility and the relocated mobility area, determine other needs as regards the small station: needs for multiple rail services - to Paris, but also nearer stations - and needs for inter-modal services. This group's biggest demand is for the construction of huge, free car parking spaces as close as possible to the small station. They have fewer needs for other services: the shops near the station are not necessarily the local shops of these inhabitants.

Finally, they are split when it comes to the creation of a housing offer close to the station: for some, it does not concern them directly, others are afraid that the densification of buildings in the station quarter will hinder physical access to the station and, more widely, traffic flows in this area.

Conclusion

In the eyes of the urban and transport planning authorities in the Ile-de-France Region, a vision is emerging of an object of public action with many virtues attached to it. Our work, however, leads us to consider that small railway station projects cover a range of programmes with, uniquely or transversely, three objectives: optimisation of traffic, a service and technology-based approach to consumption in a mobility situation, and extraction of value from the land and buildings. The arguments put forward concerning these station projects are too formatted and the technical schemes highly pre-determined. These programmes are being projected onto local realities that are in fact highly complex. Finally, the keys to translating and adapting these small railway station projects, have not been provided by the dominant operators, which means that they are regarded with a great deal of caution by the local actors. But the subject is political and it is urgent, if we are to believe forecasters who are betting on an urban exodus for sanitary reasons (climate change and heat island effect in the centre of Paris, pandemics). More effort to make plans for these small railway stations part of the democratic debate could lead to an unblocking of the situation in two ways.

By accepting that there is more than one model for efficient stations and station quarters, new, more explicit ways could be found of setting out how spaces can be shared and compromises negotiated locally in terms of accessibility versus the distancing of social groups and urban resources, in terms of protection versus exposure of local communities to the effects of rising land and property prices, in terms of the effects of station projects on socio-economic trajectories in the territories. It would then be possible to cast light on what is going on behind the scenes in the sometimes violent conflicts of interest that are emerging and obstructing the projects, whilst going beyond the screen of local political slogans (mobility, proximity) and the current stranglehold of metropolitan development doctrine (density, intensity, centrality).

**DELFT - PARIS
WORKSHOP**



Living Stations: Workshop Introduction

Nacima Baron, Olindo Caso, Yagiz Soylev

The Living Stations workshop took place in February 2020 with the collaboration of TU Delft, Université Paris Est and Gemeente Rotterdam. The workshop session was hosted in TU Delft campus, with accompanying excursions to Rotterdam.

The general aim is to establish connections and exchanges between students from different parts of the world and different academic agencies (TU Delft and University of Gustave Eiffel) for reciprocal understanding, as they will be the key actors responsible of 'our common future'.

The specific goal of the workshop is to help the comprehension of the multi-layered and multidisciplinary condition of the contemporary station, both considering it as a building/spatial organism, and as part of a territorial system (network, urban area).

The participants are given 10 themes focusing on different aspects of stations. These themes are elaborated by the analysis of case studies from different contexts selected by the students.

The workshop is concluded with a pecha kucha session where the participants present and visualize their experiences both as 'commuters' and 'users' of urban spaces all over the world, and as 'experts' from different disciplines whose point of views contribute to a better understanding of the contemporary station.

1. Station as a public space

Specific situations in which the design/experience of public space is an integral part of the station, both formal/informal and interior/exterior.

2. Station as a node of a network

The relationships between the specific node and the network, and about how a concentration of (mobility) possibilities conjure up to inform the node.

3. The station as a creator of urban values

The mechanism of creating urban values using specific examples of do's and don'ts.

4. Uses & Re-uses of infrastructure and stations

The experiences of infrastructural heritage, their continuity in time and their new lives.

5. Programmatic diversity in stations

The programmatic hybridity that characterises many of the contemporary stations, as parts of urban situations including living, working, recreating, amenities.

6. Virtual stations

The virtual side of mobility is enabled by ICT applications and the use and gathering of big data.

7. Movement and Wayfinding in stations

The flows, efficient mobility and the factors and devices which influence orientation and movement in a station.

8. Station user profiles

Diverse user and commuter profiles and their influences on the layout and design of the stations.

9. Vertical Movement – up & down in stations.

The design of routes, vertical planning in stations, and efficient, safe and reliable access to mobility.

10. The hidden side of stations – people & logistics

All aspects that are not immediately visible or that imply a 'parasite'-like relation to the station. The machinery, the use of the station by marginalised people, micro-cultures, street artists, or as an event location.

Workshop Themes

Hybrid centres of multicultural public life



Program diversity



Use & re-use of infrastructure



Urban Value



Station's users profiles



Public space



LIV STAT



Movement and wayfinding

Inspiring city-embedded nodes of mass agency.

ING IONS

Efficient nodes in the local geographies of qualities and opportunities



The hidden side of stations – people & logistics



Station as node in a network



Virtual stations



Vertical organization



Collective Workshop Session
Complex Project Chair's studio space



Nacima Baron
Lecture Presentation



Marc Verheijen
Lecture Presentation

Photo-Documentation



Collective Workshop Session
Room 1



Collective Workshop Session
Room 3



Collective Workshop Session
Room 2



Collective Workshop Session
Room 4

**ROTTERDAM:
10 VISIONS X 5 LOCATIONS**

R



ROTTERDAM

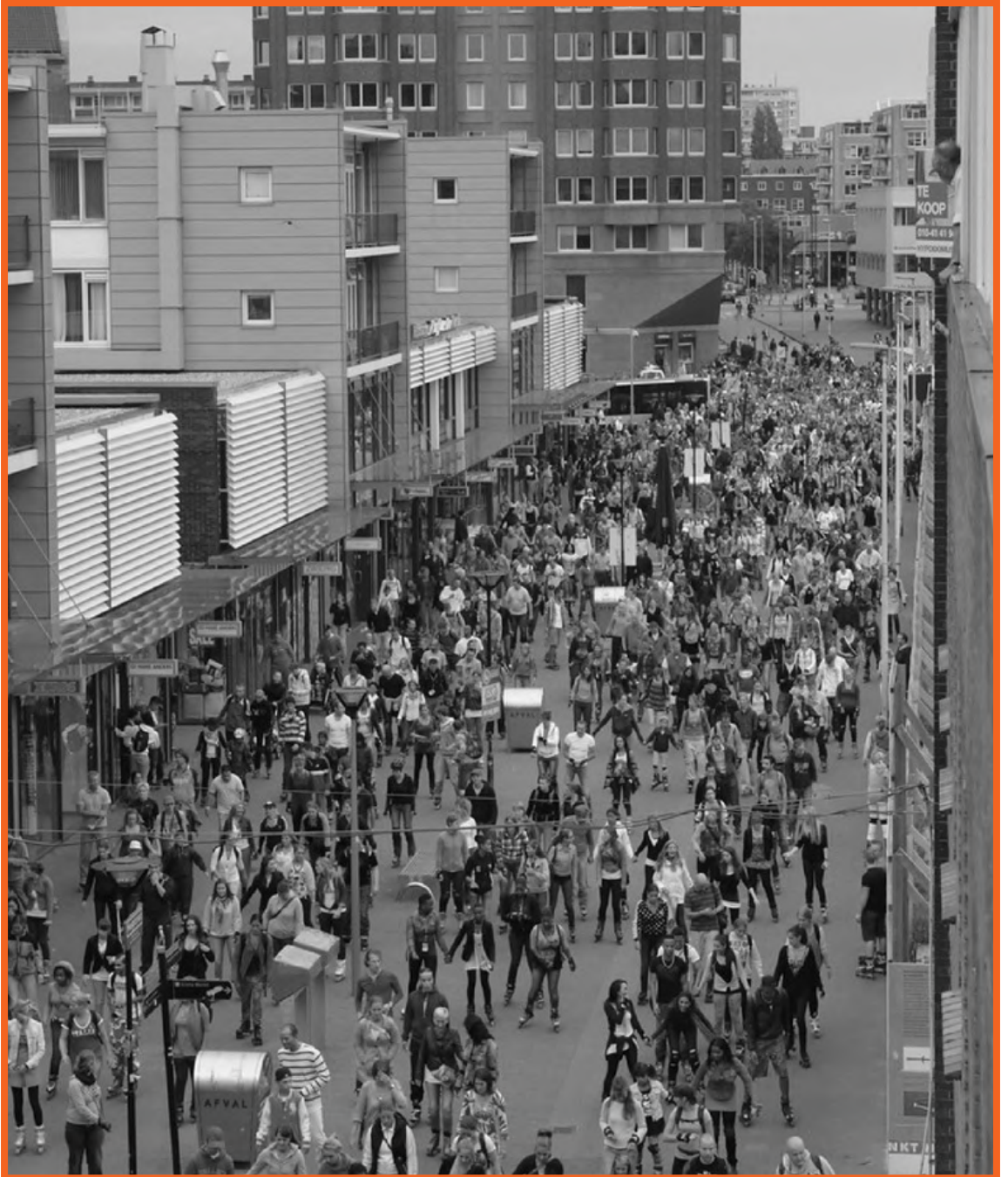

15 % POPULATION GROWTH

© "Wednesday Skate Night Rotterdam, 10-08-2011" by Guus Krol is licensed with CC BY-NC-ND 2.0.
To view a copy of this license, visit <https://creativecommons.org/licenses/by-nc-nd/2.0/>

2 0 4 0



50.000 NEW HOMES, 100.000 NEW INHABITANTS

© "De Trap III, Stationsplein, Rotterdam, 20160606"
by G · RTM

ROTTERDAM



DENSIFICATION

Pre - War
City Centre Rotterdam

© Tom Jutte



NOT EXPANSION

Post - War
Residential Districts Rotterdam

© "Netherlands-4688 - View from the top" by
archer10 (Dennis)

Case study - Rotterdam Circle Line

Wouter Kamphuis

The City of Rotterdam is looking forward. Now, more popular than ever, the city attracts new residents every day, but it wasn't always like this. Ever since the bombing during World War 2 and the vigorous urban renewal ordered by city officials, it has been a steep climb back to the city we now know and love. Urban planning has played a great part in this, as much so our notion of mobility, or rather proximity, to the city. The metro illustrates this better than many. But what will the future of Rotterdam hold? With climate change, densification and the circular economy on the horizon, to just name a few. What direction is the city headed towards 2040? And dare we say 2070?

Origin

In 1968, princess Beatrix and prince Claus of the Netherlands officially opened the first metro line of Rotterdam. At that time, it was the most modern subway line in Europe. One could argue it is a primary reason why now, 50 years later, the city is able to transform one of its major streets, the Coolsingel, in a way that places pedestrians and cyclists first and turns down on the volume of cars in the inner-city. This redesign of the public space for movement is trending and has gained tremendous support in the past years. For a city like Rotterdam, that has been very generous to the car in its urban renewal, it is both a challenge and a gift to transform these wide boulevards to new public spaces where moving and being coincide. Given what we know now, how would that influence our decisions in mobility for the urban fabric moving forward?

Estimates

The metro has been one of the most efficient modes of transportation in dense urban locations. A service for many passengers moving quickly, safely, comfortably and at relatively low cost for users. For as long as Rotterdam has been planning new metro lines or stations, the success of the investment has been challenging to predict. More often than not, ridership soars beyond double the (seemingly conservative) estimated values as soon as a new line opens. This was the case for the recently opened Hoekse Lijn. But also, the case for Beurs, centre point of the Rotterdam metro, that had to be expanded several times after it was first built. Along with an average growth in public transport passengers of 3% every year, the station is again stretched to its maximum capacity. Every development in the metro network has had a great impact on how the urban planners envision the future of the city and continues to play a crucial part many years later.

Trends

In the past 50 years, Rotterdam has given place to several trends in urban planning, with each trend fitting its own development in the metro network. The first line connected the city centre to the new leisure and retail program of Zuidplein. The further expansion towards new town suburbs for living and recreational purposes, opposing the -all work- busy city life in "the mother town". The revival of the city as a place to live, spend leisure time and having amenities nearby was underway. The transit-oriented development of mobility hubs and using public transport stops for high-density mixed-use city program catered to this. The adoption of existing train corridors like Hoekse Lijn and Oude Lijn to play a focal point in the greater metropolitan area development furthered this trend. This metropolitan transport shows a growth by means of additive "links" over time that exhibit clear choices in policy for the growth of the city and the region.

Densification

The demand for housing in the Netherlands is rising. In stark contrast to 20 years ago, a large amount of these houses will be located within city limits. For Rotterdam this means an estimate of 50.000 newly built housing units to be realized between 2020 and 2040. The estimates suggest it fair to expect another 50.000 units from 2040 to 2070. In previous times when faced with similar challenges, policies promoted the development of suburban towns like the vinex-wijken, often built in high speed and lacking quality public transport allowing for the car as primary mode of transport. Now the focus lies firstly on locations near high quality public transport stops. Locations in the city centre and along the train corridors adapting metro lines. After that, the department of city development has allocated stretched zones at the edge of the current city centre yet well within city limits.

East-West Flank

In order to better structure this growth, the city-council has established an urban development strategy. 50.000 housing units, what they require in amenities and public services and the course in which these will be developed in the coming 20-some years; clearly showing an East and West flank embracing the city centre. Matching this is the new high-rise vision (2019) stating places like Feyenoord City, Hart van Zuid and Alexander Knoop, as off-centre places that will allow for high-rise of up to 150m tall. This shows the first steps moving from a mono-centric high focus on Beurs and city centre

towards a more poly-centric network of sub-centres with unique qualities and with their own measure of self-sufficiency. When imagining the city of the future many variables need to be taken into account. Looking 50 years ahead is difficult, let alone 20. Still, the examples given by the current metro still having impact 50 years after its realization presents us with a reason to look ahead as much as 50 years. Not to completely plan out the future but rather to once again relate the growth of the city to the means used to move around. Especially now, with the much-needed attention for health and sustainability, the scales are tipping in favour of cycling and public transport.

Research by Design

The flanks not only show an area of interest for building following a time-line. There is also a use of arrows stating a wish for connection and relation along zones. In order to better grasp what this connection might be we use a method called research by design. In this, we use design as a tool to both solve and make a puzzle at the same time. Here, design is not used to formulate the best answer or solution to a challenge, but to formulate multiple scenarios and explore a challenge from a variety of vantage points. This, in turn, informs us of the challenge and befitting scope. In this case 50.000 housing units, in 20 years time, along an east-and west flank, with a demand for connection and adding to the mobility in the urban fabric is the context. Vantage points can vary in the type of transport, measure of density and mix of urban program among others. When combining the urban development strategy for the coming 20 years with the long-term return on investment of a metro line, as stated in the example of the Coolsingel, the mind lingers to think of this urban development in a 50 year time frame. When we don't have to transform the Coolsingel 50 years after but design it like this right from the start. What could the urban fabric along the east and west flank look like bearing this in mind?

Metro Circle Line

When aligning some of the more daring long-term plans for Rotterdam, one could envision the flanks as two-thirds towards a circle shaping around the city. Time will show if parts to the north, like the airport and Hillegersberg will eventually be part of this network. But connections like Schiedam and Zuidplein have already been advocated as much as 10 years ago. More so, the city is currently researching the possibilities for a new river crossing making the connection from Zuidplein to Kralingse Zoom and part of the question is could

this be done by means of a metro? When allowed a time frame of 50 years, could this connection be in fact a first segment of a circle line? Connecting Schiedam, Zuidplein, Feyenoord City, Kralingse Zoom, Alexanderknoop, Meijersplein and the airport. What if we approach this network not as adding piece by piece, but conceiving it as a whole from the start? What will we learn?

Means

The first "underground" line was quite simply needed to mitigate traffic congestion in downtown London. The situation was so dire that the idea of digging a tunnel underneath the roads big enough to fit a steam train sounded like a good idea. The years of experience and research since then shows that infrastructure is not "merely" affecting traffic. High capacity infrastructure allows for high density planning, efficient amenity proximity, growth in jobs, economic activity and agglomeration effects, just to name a few. Infrastructure has become a, if not, the tool for government and municipalities to deliberately steer urban development in strategic directions. Next to the "usual hustle" cities are now faced with new and even more pressing challenges such as urban climate adaptation, the circular economy and sustainability. This has led to a growing number of high-impact decisions, or "grand-projects" made by cities worldwide. These projects require to think about things holistically; seeing how changes in one domain impact other domains; understanding interdependence; leveraging chaos, complexity and emergence to eventually arrive at integrated strategic development. Architecture & planning operates on the brink of prediction and uncertainty; between the big picture and personal viewpoints; between planned and emergent change; between globalization and localization. How can this view relate long term policy to the built environment?

Locations

The future holds many uncertainties. This demands long term strategies to remain flexible, allow for the occurrence of change and fluctuation in progression. Can parts of a whole function sufficiently on their own? Can we build a grand project down to self-sufficient segments as opposed to additive manufacturing eventually resulting in somewhat of a new standalone metro line? That is why, following the vision of the circle, several locations present themselves as primary influencers of the current debate for a river crossing and the possible start for a new line in the transit network. Locations that showcase potential and influence

public opinion by means of design-based research. These locations are found in the Eastflank between Alexanderknoop and Feyenoord City. An area stretching 8 kilometers with a first estimate capacity of 25.500 new housing units in the time period of 2020 to 2040. Along this line station locations are suggested at Kuip, Esch, EUR, Kralingse Zoom and Boszoom.

Challenge

Grand projects carry the apparent possibility to line up as grand failures. Learning from the hit-and-miss planning from previous decades, long-term plans are now often fitted in scenarios and adaptive strategies. Think of it as spreading the odds as opposed to betting everything on one number. The value of adaptive strategic planning is that everything from planning, expenses and speed to growth and stretch is fluctuating in correspondence with regional and even national economic growth. This reduces risks and shrinks the loss margins and allows for a more emergent organic type growth. The evident problem is that most, if not everything, risk is in equal balance to reward / value. High risk, high reward anyone? Although this seems evident, infrastructure investment can actually be a lot less high risk and even purposefully beneficial when used correctly. Grand projects have proven a highly effective means to in fact counter periods of recession and can be used effectively to "keep the ball rolling", putting the city on the starting line-up for the economic wave. Infrastructure can be seen as the physical dedication of government and municipalities that the city can, quite literally, build on. How can we use these long-term investments as a strengthening backbone to adaptive strategic urban planning? Can we come up with a new hybrid or something like the adaptive grand project? This will estimate how much and what dedication the city should provide in the long term while at the same time leaving room for adaptive planning and growth in the short term. A merger of the 50+year and 5+year plans.





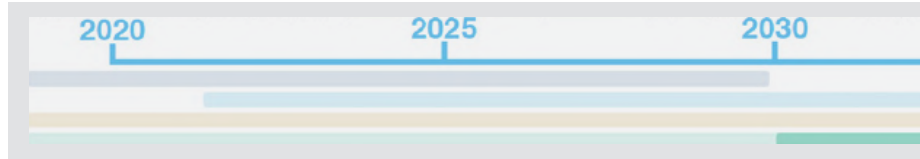

Conclusion

Rotterdam attracts new residents every day. When contemplating what direction the city is headed towards 2070, much can be learned from the city's history. In the past 50 years Rotterdam has given place to several trends in urban planning, with each trend fitting its own development in the metro network. This metropolitan transport shows a growth by means of additive "links" over time that exhibit clear choices in policy for the growth of the city and the region. The demand for housing in the Netherlands is rising. In stark contrast to 20 years ago, a large amount of these houses will be located within city limits. After that the department of city development has allocated stretched zones at the edge of the current city centre yet well within city limits. In order to better structure this growth, the city-counsel has established an urban development strategy. 50.000 housing units, what they require in amenities and public services and the course in which these will be developed in the coming 20-some years. When aligning some of the more daring long-term plans for Rotterdam one could envision the flanks as two-thirds towards a circle shaping around the city. What if we approach this network not as adding piece by piece, but conceiving it as a whole from the start? Grand projects carry the apparent possibility to line up as grand failures. Learning from the hit-and-miss planning from previous decades, long-term plans are now often fitted in scenarios and adaptive strategies. The future holds many uncertainties. This demands long term strategies to remain flexible, allow for the occurrence of change and fluctuation in progression. Can we come up with a new hybrid or something like the adaptive grand project? This will estimate how much and what dedication the city should provide in the long term while at the same time leaving room for adaptive planning and growth in the short term. Take a moment to reflect on the importance of transport networks within and extending from the city.

Consider the way these networks have shaped the city through weaving the urbanities of the city centre(s) and suburban areas and how they will further shape the future urban territories. Expose and strengthen the negotiation between architecture, network, infrastructure, public realm, policy & governance and the territory.



ONTWIKKELRICHTING NIEUW PLANAANBOD

-  Prioritaire Gebiedsontwikkelingen
-  Binnenstad
-  Oostflank
-  Westflank
-  Beter Benutten
-  Oude Lijn
-  Aantal Naam Aantal
Bovenkant potentiële woningen
Zoekgebied
Onderkant potentiële woningen

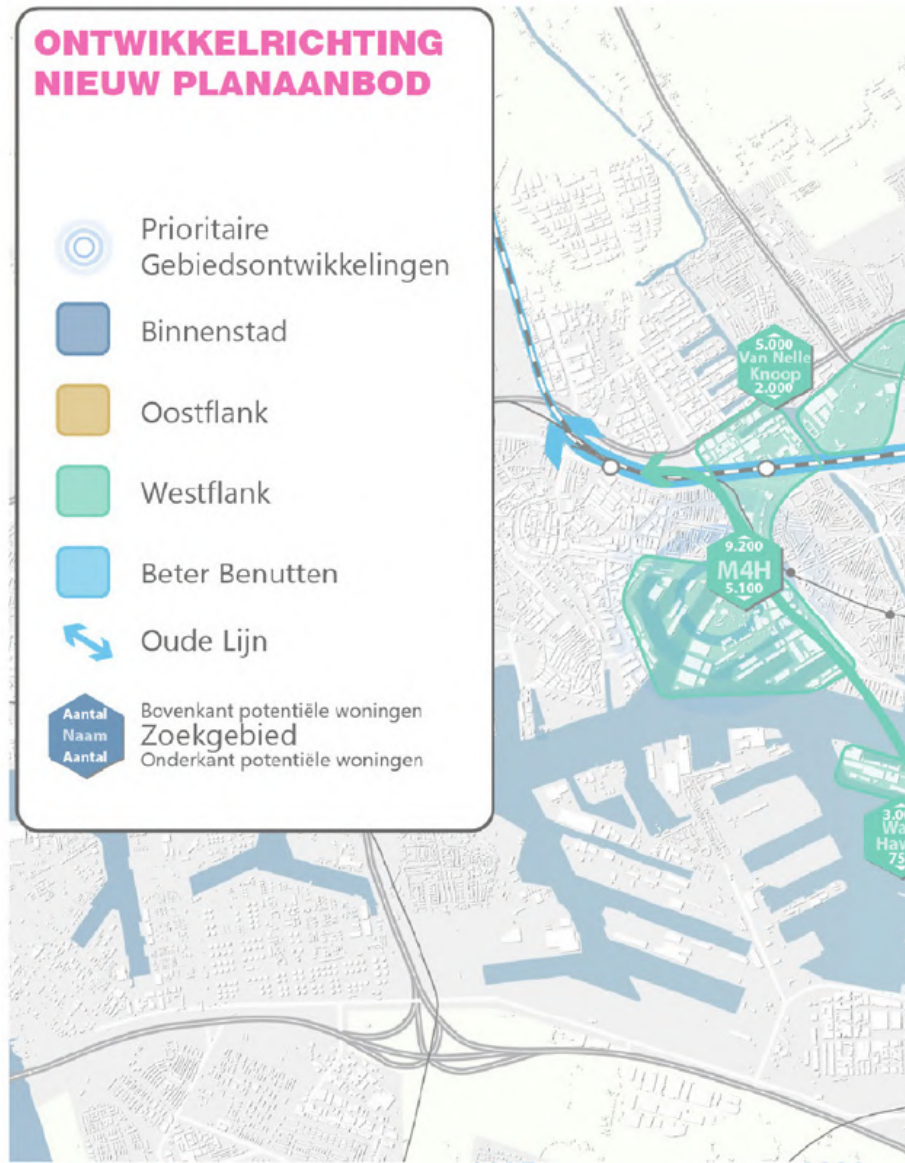

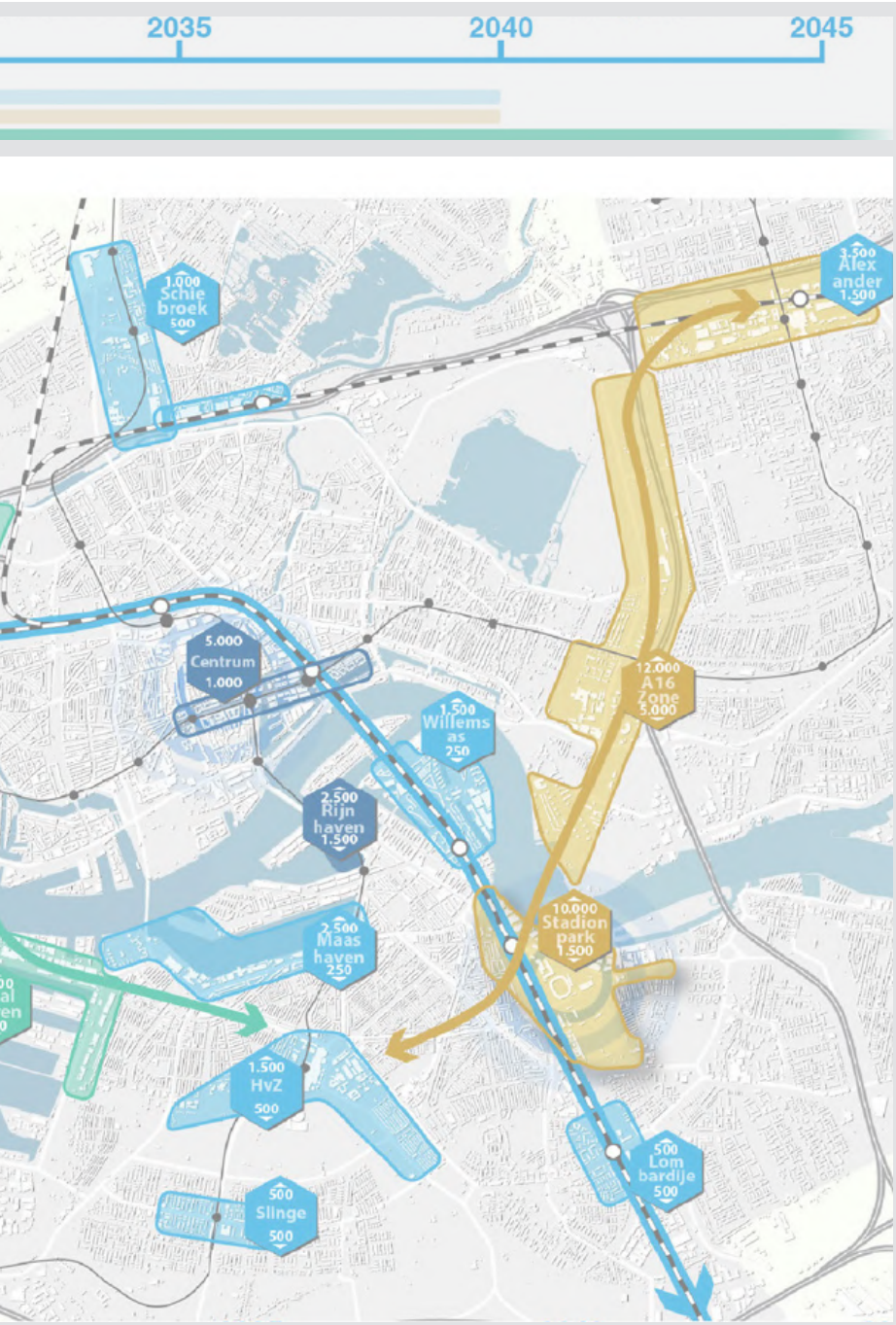

Ontwikkelrichting nieuw
planaanbod 2019
© Gemeente Rotterdam

ROTTERDAM CIRCLE LINE



C

E



B

C

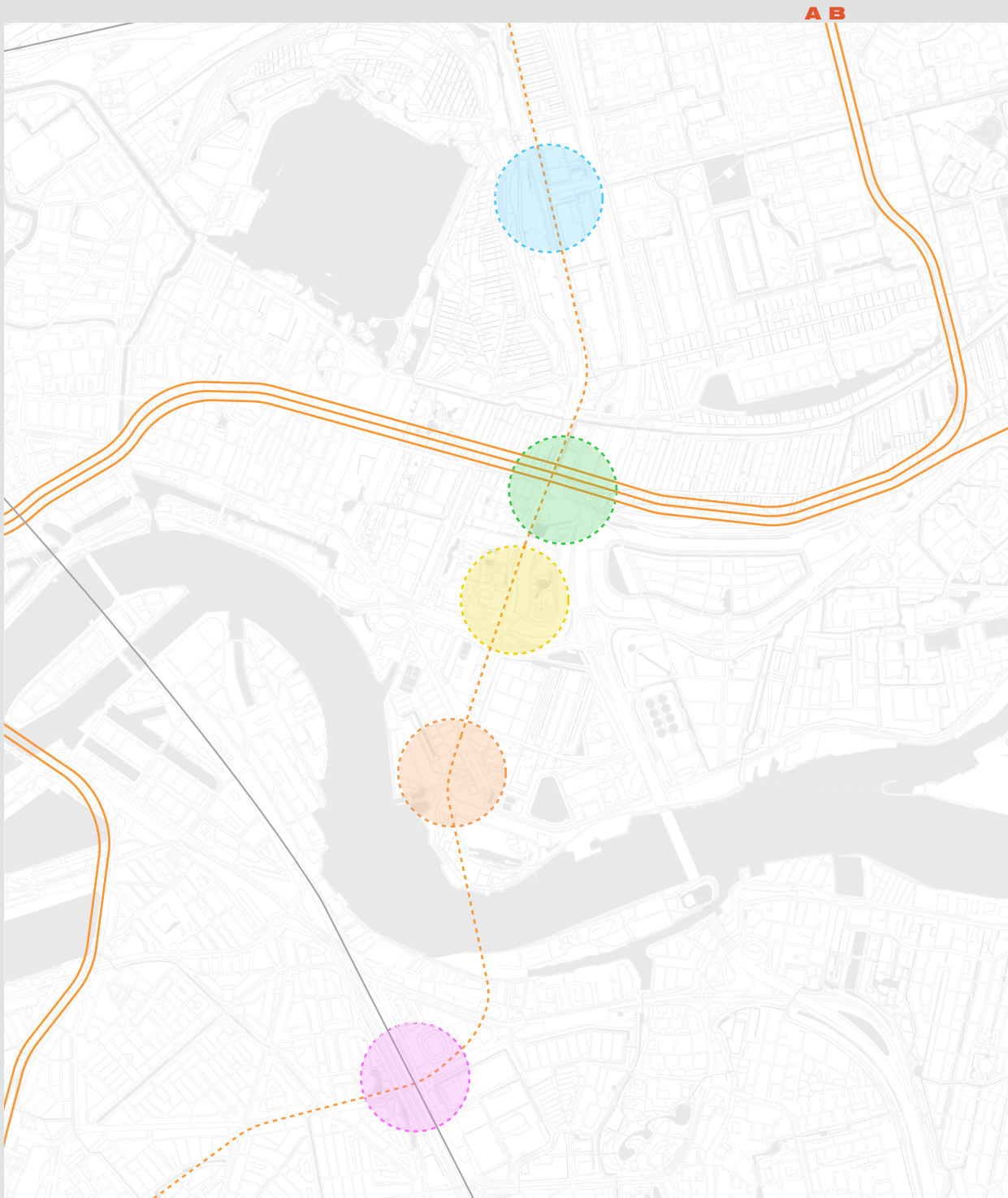

 = 700m

Map of Stations
Station circles represent area of influence

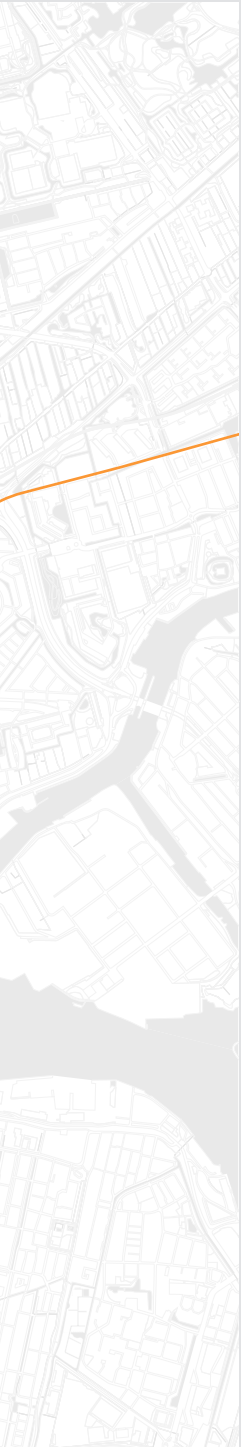

Bos Station

53



Collective Research	55
Conceptual Scenarios	65
Confetti on Cone	67
Light at the end of the Tunnel	95

Kralingse Zoom Station

111



Collective Research	113
Conceptual Scenarios	129
Killing the Car	131
Kralingseberg 2030	151

Erasmus Station

185



Collective Research	187
Conceptual Scenarios	201
Rings	203
Erasmus Park	227

De Esch Station

251



Collective Research	253
Conceptual Scenarios	267
Amusesch	269
The Living Station	291

Rotterdam Zuid Station

311



Collective Research	313
Conceptual Scenarios	325
Feyenoord	327
Connecting the fragments	346

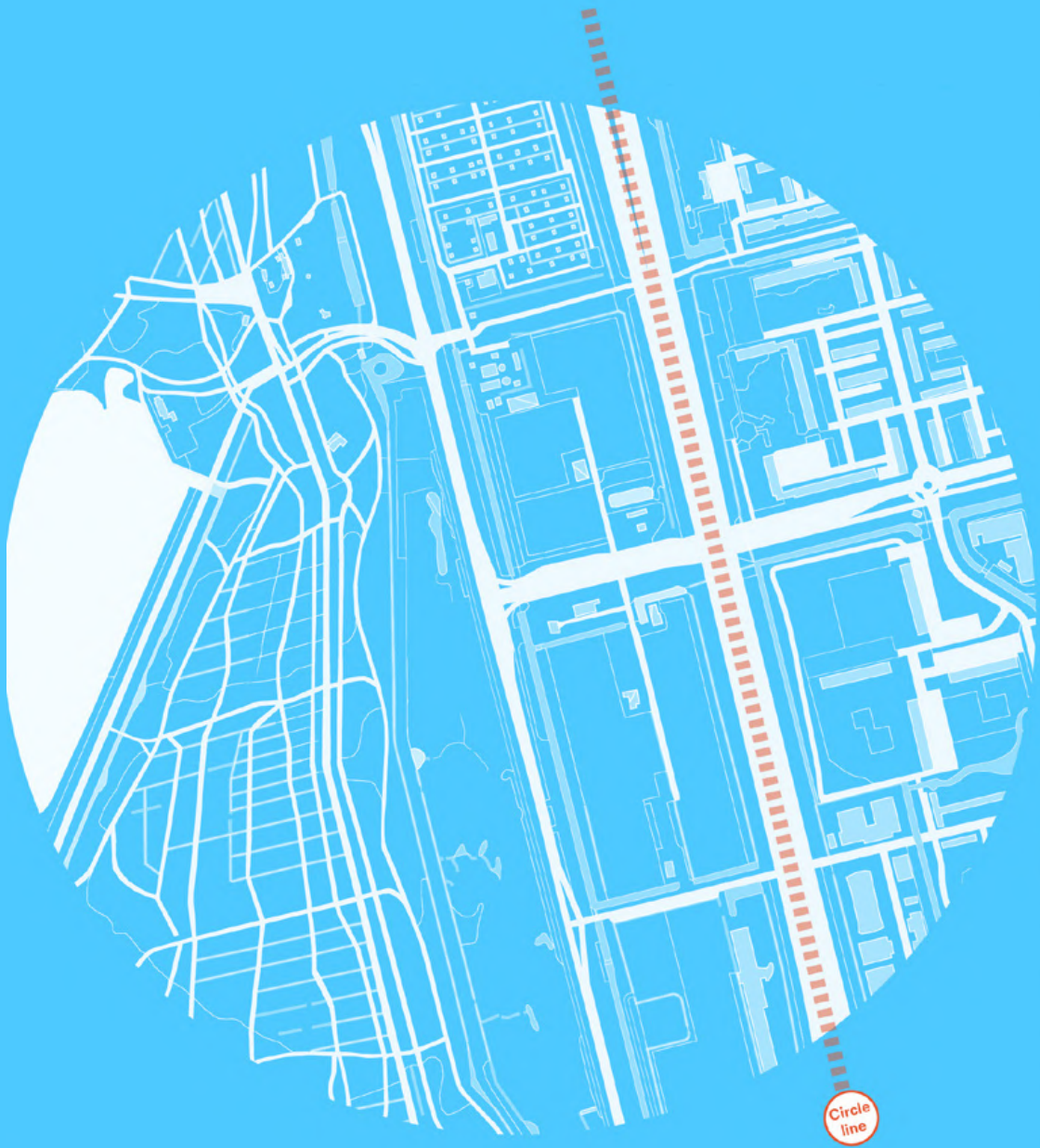

B

BOS

Collective Research Location & Characteristics	55
Conceptual Scenarios Visions	65
Disperse! Confetti on Cone	67
Concentrate! Light at the end of the Tunnel	95

Hannah Zhu
Ervin Muhovic
Isaac Vaarzon Morel
Maciej Moszant
Izk Chan
Tamas Dongo
Wessel Herrewijnen

History

Kralingse Bos

Looking into the history of Kralingse Bos and the extended surroundings, it becomes clear that what is considered part of Rotterdam today was only the surrounding wetlands before the turn of the 19th century. Within the first half of the 20th century, most of the swamps were turned into polders; land reclaimed to be used for agricultural purposes.

What appears to be a diminishing urban forest, known as Kralingse Bos, was actually planned and implemented by the city in 1911 as a recreational park that as grown in its size until the mid 20th century. At the same time, Rotterdam started growing towards east, with row houses indicating a more structured and planned city growth.

An important step towards Rotterdam as it's known today was made in 1968, when the first metro lines were introduced to the city centre. With prospects of extending these inner city lines an entire district with diverse social housing was established east of the forest in less than a decade.

Strengthening infrastructures, highway and metro expansions in the 1980s led to strong densification over the course of 30 years. Today the areas "Het Lage Land" and "Prinseland" are strongly defined by a mix of large scale housing units and row houses.

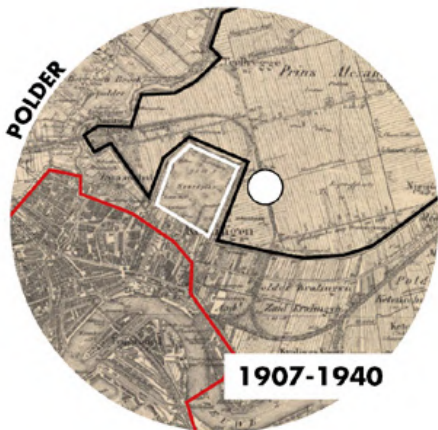

Demographics

Both Prinsenland and Het Lage Land have quite similar inhabitants characteristics. Large portions of the neighborhood consist of social housing or low rent apartments. In Prinsenland, there seems to be a more mixed selection of incomes due to some more expensive housing that was realized in the 1990's to 2000's.

The age spreading in both Prinsenland and Het Lage Land are somewhat comparable, showing a somewhat more larger peak in the category of 45 to 65 years (possibly due to the houses realized in the 1990/2000's).

Statistics about the migration background and characteristics show again a comparable figure for Prinsenland and Het Lage Land.

The neighborhood of Kralingse Bos is much more different than Het Lage Land and Prinsenland. First of all, the number of inhabitants living there is considerably less, and because of the main function as a recreation or green area in the city, the dwellings that do exist in the neighborhood are of much different typologies.

Density per neighborhood:

Kralingse Bos: $105 / (4,47 \text{ km}^2) = 23,5 \text{ inhabitants/km}^2$
 Prinsenland: $9.895 / (1,79 \text{ km}^2) = 5528 \text{ inhabitants/km}^2$
 Het Lage Land: $10.350 / (2,16 \text{ km}^2) = 4792 \text{ inhabitants/km}^2$

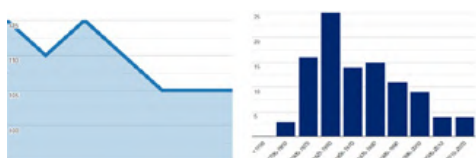

Number of inhabitants Kralingse Bos 2019: 105

Construction years buildings in Kralingse Bos



Number of inhabitants Prinsenland 2019: 9.895

Construction years buildings in Prinsenland



Number of inhabitants Het Lage Land 2019: 10.350

Construction years buildings in Het Lage Land

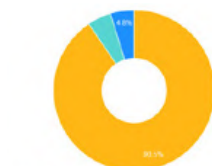
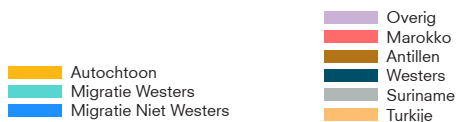

Migration Kralingse Bos



Migration background Kralingse Bos

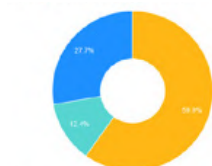

Migration Prinsenland

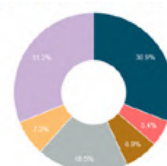

Migration background Prinsenland

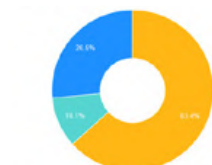

Migration Het Lage Land

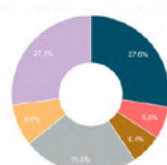

Migration background Het Lage Land

Amenities

Use and Program

Evidently, there are three categories of amenities present in Bos area: the dominant amenities (at the bottom of the legend), which includes sports, housing and car-related services; then liveability amenities (at the middle), which presents a 'one-of-every-kind' trend; the lastly, the highlight amenities (at the top), which are education and care services.

Through the colours and patterns of this amenities diagram, we see the dominant amenities each occupying a defined territory, creating two bands of program - a red sports ban and a green housing ban) with the liveability amenities sprinkled amongst them. The liveability amenities show patterns of clustering at the north and south side of this area, with emerging possibilities at the central axis. What can be concluded is that the chosen location for metro station is a space between two amenity service zones - thus, the station can make use of its proximity to these services whilst providing new opportunity to change the existing rigid zoning of dominant amenities.

In a simplified fashion, a survey of the area's current amenity arrangement also suggests potential in the east-west direction. Since each strip in this direction already holds a significant identity (nature, sport, residential), how to infiltrate them with a metro station operation is our next question.

Sports Facilities

Overview & Mapping

The assigned area stands for the main and the biggest sporting centre serving Rotterdam's inhabitants. The site provides a large number as well as the variety of sporting venues.

These include following facilities:

- 6 hockey fields,
- 12 football fields,
- Rugby field,
- 12 outdoor tennis courts,
- Golf course,
- 2 horse stables,
- Shooting range,
- Sailing school,
- 2 fitness centres,
- Local football field,
- Squash courts,
- Ice-skating club,
- Paint-ball centre,
- Martial arts clubs

As a feature giving the specific characteristic to the Bos site, sporting facilities and approach to them in the future had been situated at the centre of considerations on design proposals that the both assigned groups of students was elaborating.

2



12 13



8 9 10 11



14



6 7



19



15



16 17



18



3 4 5



1



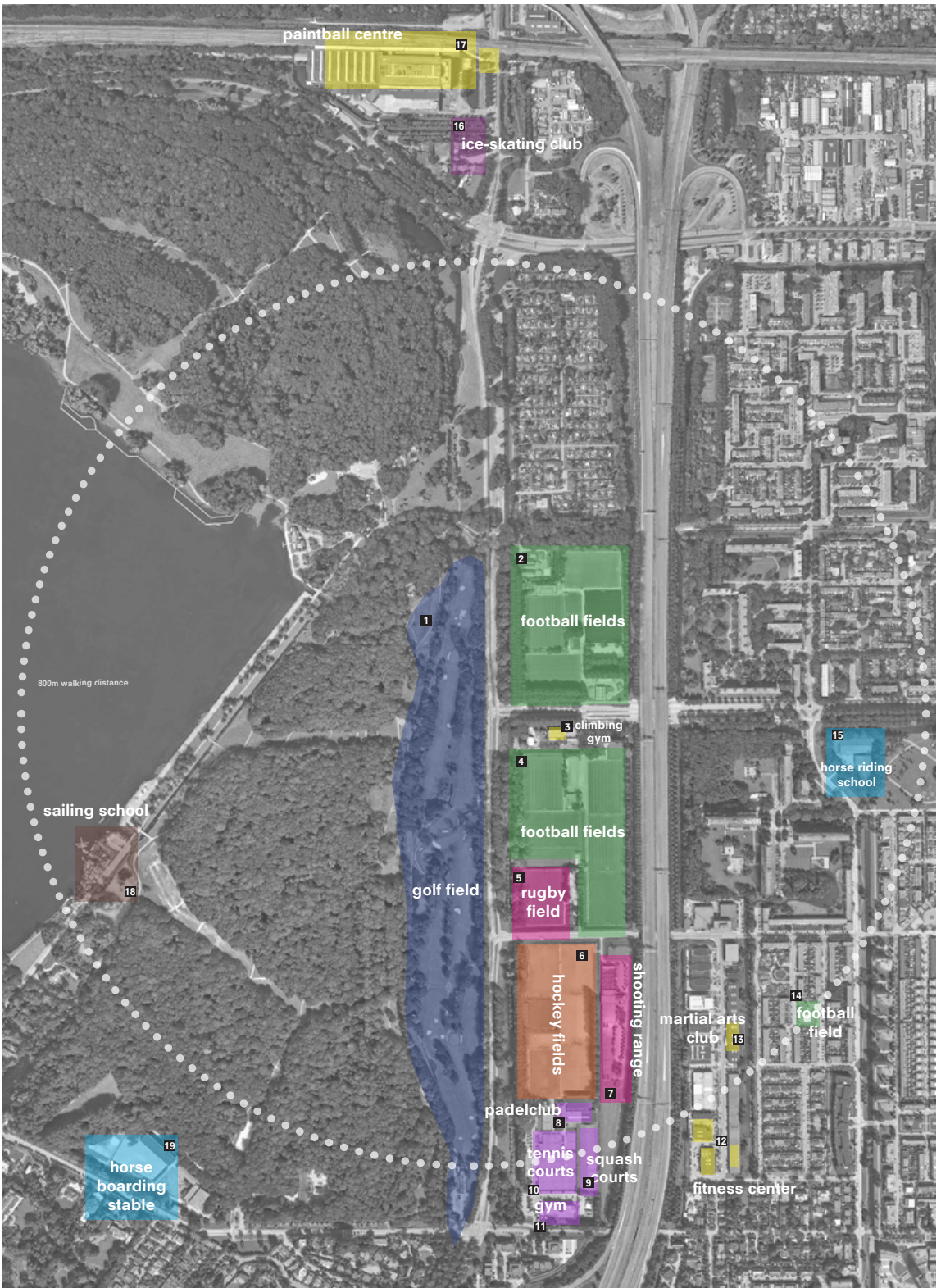

Sporting Facilities
 Satellite Image - not to scale
 Source: Google Earth

Road Network

Existing Conditions & Recommendations

The hatching indicates the elevated A16 Alexander highway. It is paralleled with the proposed circle line. Vehicles mainly approach to the site from North, West and South. Secondary streets are Mainly distributed in residential and commercial area in Het Lage Land. The connectivity in the central area can be enhanced through the new station. The central areas are the roads around the sport fields of the social and cultural clubs.

The site can be accessed by cycling in various directions. However, the connectivity in the southern area is weaker. The accessibility by cycling at the southern area can be refined.



Public Transport

Existing Conditions

Kralingse Bos is at the south of the North East railway. The site is located between the Noord and Alexander stations.

There are three metro stations between 1.5 - 2km approximately from the centre of the site. These transportation nodes are Kralingse Zoom, Capelsebrug and Alexander. Three metro lines run at the south, two lines run at the east. The Tramway operates at the south of the Kralingse Bos area. A bus lane passes through the Het Lage Land and Prinsenland.



Road Network

Car, Bicycle, Pedestrian & Flow of Goods

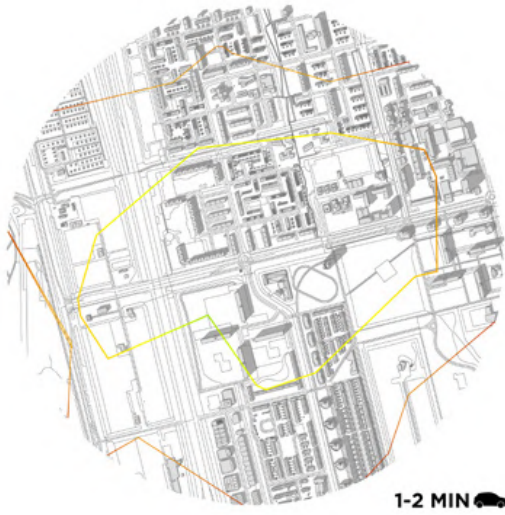

Isochrone map of the area using car

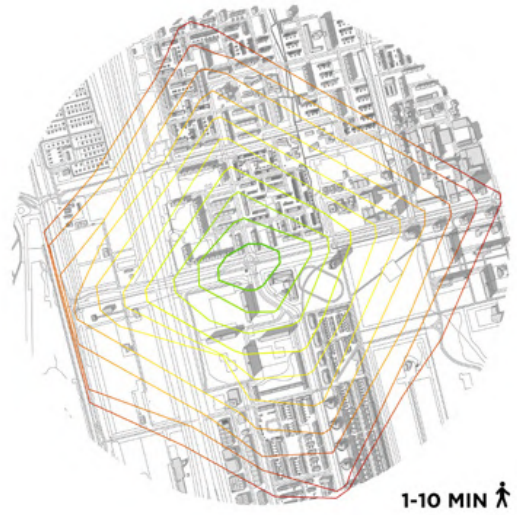

Isochrone map of the area by walking



Isochrone map of the area using bicycle



Isochrone map of the different amenities

Housing Typologies Diachronic Mapping



-  Portico/Gallery Blocks 4 < stories
-  Portico/Gallery Blocks =/< 4 stories
-  Apartment Blocks w/ central enclosed stairs
-  Row Houses
-  Detached Houses
-  Semi-Detached Houses
-  Private Blocks (Closed Streets)
-  Apartment Blocks (Elderly)
-  Caravan Camp
-  Villas
-  Sheltered Housing
-  Upstairs/Downstairs Dwellings
-  Apartment Towers

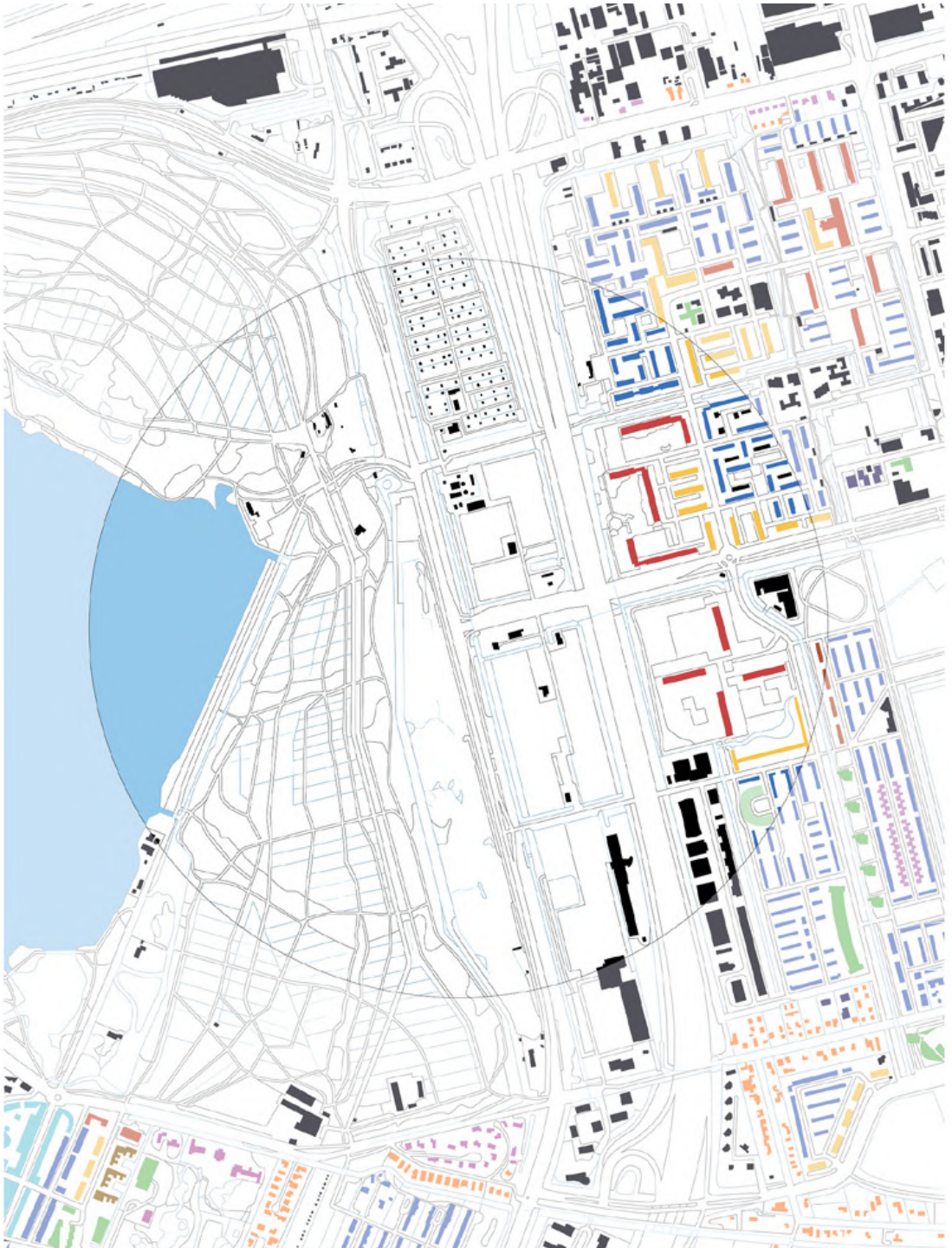

Housing Typologies
Diachronic Map



Confetti on Cone

Bos Station
Disperse!

Ervin Muhovic
Maciej Moszant
Isaac Vaarzon Morel
Hannah Zhu

“Confetti”

Concept Summary

The new metro station “Bos” will be placed in between Prisenland, Het Lage Land, and Kralingse Bos areas, all situated in the Eastern part Rotterdam. Both Prisenland and Het Lage Land stand for the areas highly dominated by low-rise housing, mainly row-houses. The relatively small number of retail is also present. Kralingse Bos stands for the area holding a recreational function. The site includes one of the largest parks in Europe as well as Kralingse Plas lake. In between the above-mentioned areas the strip, limited by A16 highway and Bos zoom road running alongside, containing nearly exclusively sporting functions is located. These include venues like hockey fields, football fields, rugby field, tennis and squash courts or shooting range. The access to the Kralingse Bos from the housing areas is limited by the adhering golf field. Taking into account significant environmental qualities of the vast recreational space as well as the variety and multiplicity of sports facilities, the assigned area stands for the main and the biggest sporting centre serving Rotterdam’s inhabitants.

The hereby presented “confetti” concept stands for the alternative for the “hyper-sports” concept being elaborated on the same location by another student group. Both concepts operate on the presumed future scenarios for the site, settling its assumptions around the year 2050, and trying to envision its development tied to plans of densifying the area with as much as the 12 000 new housing units. The latter, “hyper-sports” concept concludes reinventing and strengthening the existing functional characteristics of sporting venues. Apart from adding the enhanced variety of sporting establishments, which intends to make the area more accessible and attractive for various categories of potential users, the related sporting amenities will be introduced.

Differently to “hyper-sports” the “confetti” concept envisions the diversification and decentralization of the existing area’s functional nests. Thus it’s ambition applies to situate the metro station in the highly mixed and functionally nuanced scenario of the site development, making the further design object both the product and the cause of the expected future. The hereby presented concept, apart from exploding the currently nested in the vertical strip sporting functions and spreading it all over the adhering neighbourhoods, expects to generate a new irregular connecting network that will render the accessibility to particular site’s attractions more effective, with a particular focus on establishing the connection between the Kralingse Plas lake and the residential neighbourhoods, which is now highly restrained by current sporting strip. Despite

that, however, taking for a priority the ambition of breaking the existing axial arrangement of the strip, the directives for the further station design will emphasize the necessity of establishing the equality of the potential directions by renouncing any particular advantaged preference.

Considering the expected effects of the realized scenario, the above-mentioned vision, apart from physical (spatial) scattering, intends to disperse the now well-established characteristics of the sporting program by introducing very both professional highly specialized as well as less concrete generic sports venues. This well-nuanced mixture, offering enhanced access to more approximate (in opposite to current too much centralized) practicing site, envisages the consequential endurance of future inhabitants’ attachment to their neighbourhood and strengthening the sense of locality. As an inevitable effect of such an approach, the more often, non-professional use of sporting facilities is expected. This will directly lead to the social benefits resultant from the healthier inhabitant’s lifestyle rendering the area more attractive than it is now. In this context, the new metro station is envisioned to serve not only the citizens arriving from different parts of the city of Rotterdam and its approximates who exclusively intends to use the surrounding sporting qualities, but also the local community that – with an improved circulation on the site – will be able to access the future station more easily. Therefore, the placement of the station in the above-mentioned context will intend to become a “glocal” hub combining both types of users, namely external and native ones. What is more, overall the concept comes in line to the municipality of Rotterdam policy that in case of (re)developing a particular neighbourhood takes as a priority the aspect of mixing different types of functions in relation to the residential units.

Due to the above-mentioned directive design guidelines, the station will be placed at the junction of Prinsenlaan path and the Boszoom road. In order to achieve both - the expression and functioning quality – that will be related to the previously stated intention of directional equity, the entity of inverted truncated cone submerged in the ground being the visible from the outside part of the station has been adopted as a starting point to the further development of the design.

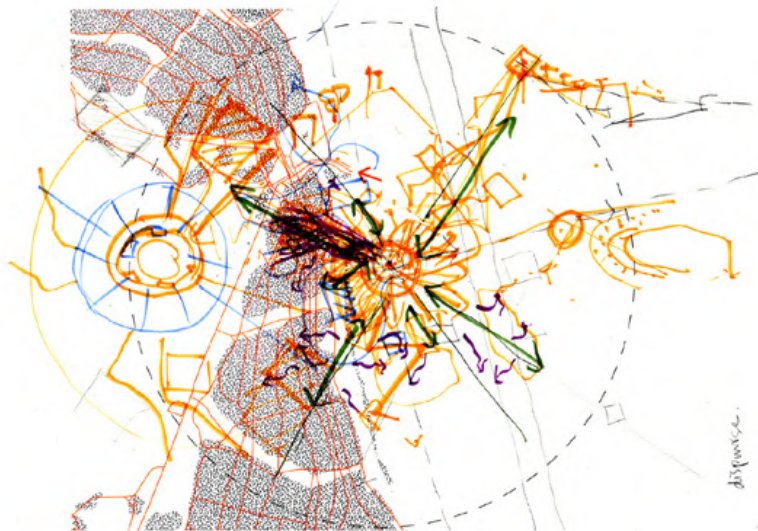
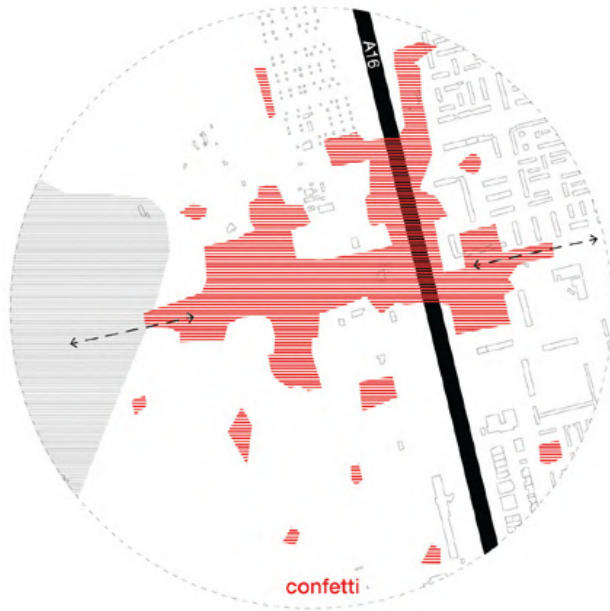

2.1 Dispersing Program

The goal of the contextual masterplan is loosening the existing rigid zoning. We observed a congestion of large-scale sporting fields in the research phase. In response, we are redistributing the exact same number of sporting fields further out, spewing them across the walking radius to make space for densification with new housing units. While densifying, giving each future architectural proposal space to stand on their own, making them entities in between the existing programs. In essence, this is an unrestricted 'play' between the existing program and new architecture.



2.2 12,000 Housing Units

The forms of new housing blocks are derived from existing fourteen-story Portico/Gallery blocks. To meet the needs of future densification this was used as a reference unit: each block containing 350 units, and 35 of these blocks re-imagined across the area. The forms are altered and diverse colours applied, as if a non-directional sculptural park of new living. The end result is the sporting strip being dissolved and losing its mono-functional identity. Therefore, the barrier between park and residential is perforated with the new metro station becoming the centre within the scattered urban arrangement.

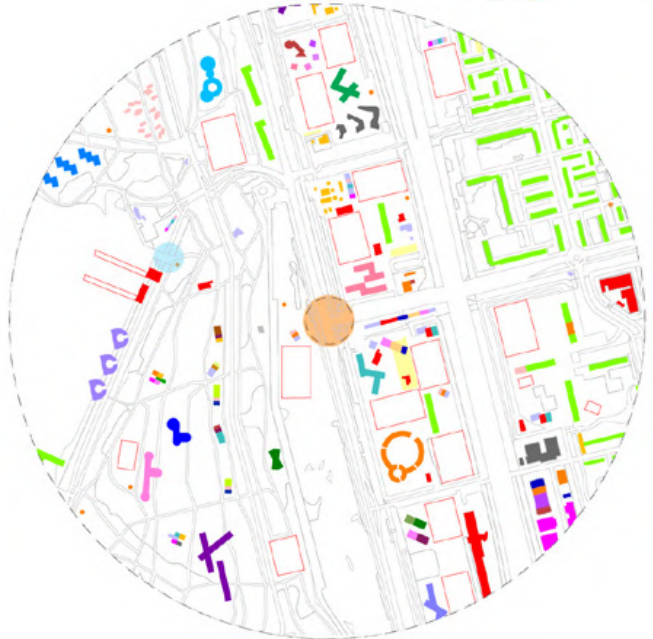

Abstract vision of the masterplan embodied in the physical model



2.3

The collages explain in chronological order how the confetti concept progresses to a widespread mix of functions and programme. The cone station acts as the centre of the newly created area. Housing projects will rapidly occur throughout the region, which will densify the neighbourhood and increase the need for amenities such as: sports, supermarkets etc.

2.4

The development of the area will have no restrictions, only that the spreading of functions and typologies are mandatory. This results into a critical urban area which engages with the surrounding neighbourhoods and acts as a playground where typologies and functions that have never met before can flourish. The station acts as a connecting entity as the region's critical centre but also as a manifestation of the development itself.

Translating Concept into Station The Cone, Roof & Entrance Plaza

How does one achieve non-directionality in station planning? We employed the physical manner of making the concept model. The traces and marks are translated into a diagram to inform the spatial arrangement of the above-ground segment of the station - the 'cone'. By 'misusing' the plans that were created on two vastly different scales, it is attempted to achieve a sort of 'randomness' whilst altering it to maintain the logic for a station to function.

The resulting plan is a first attempt at dissolving the symmetry and axial nature of the 'cone'. The confetti have become service pavilions which could house RET kiosks, information centres and food kiosks etc.; whilst the candies have become urban furniture - both positives on the cone landscape. Furthermore, there are red string liquorices becoming cut-out passages and when they overlap pocket spaces are created - negatives that create space for programs on various levels.

The existing motorway is pushed down one level - giving way for the pedestrians using the metro station. This coincidentally means that pedestrians only have the 'cone' as the means for crossing these roads, making the station an inevitable component of the intersection.

Whether or not the passages maintain a true 'randomness' and 'non-directionality' is debatable, as there is always a start and an end to every passage; however, the passages enable the station users to experience a non-linear journey, an experience that takes you through every direction and orientation till the destination is arrived upon. It merely prolongs any directionality. Hence, many of the passages are not straightforward, impractical, even slightly excessive.

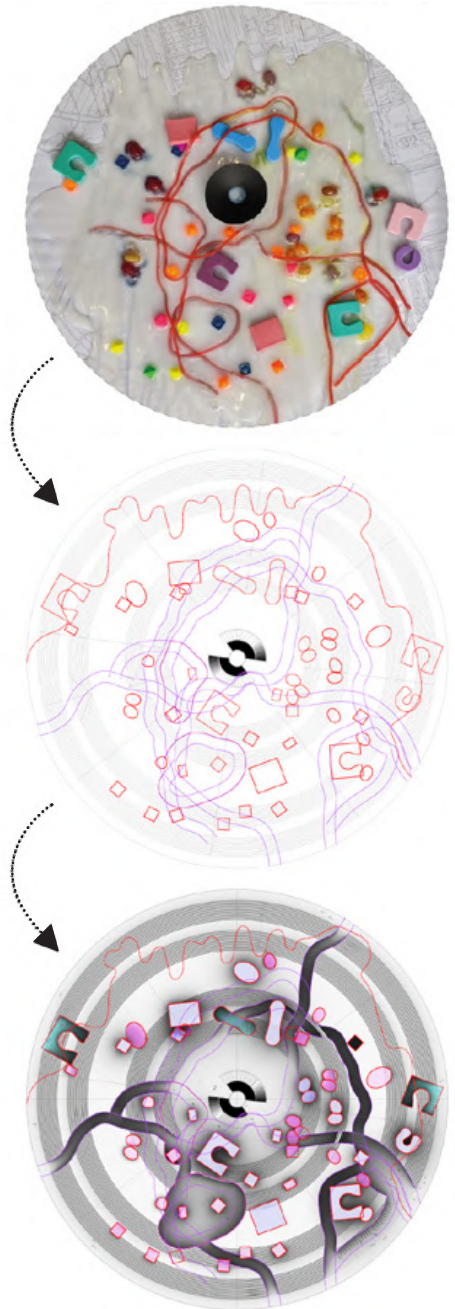

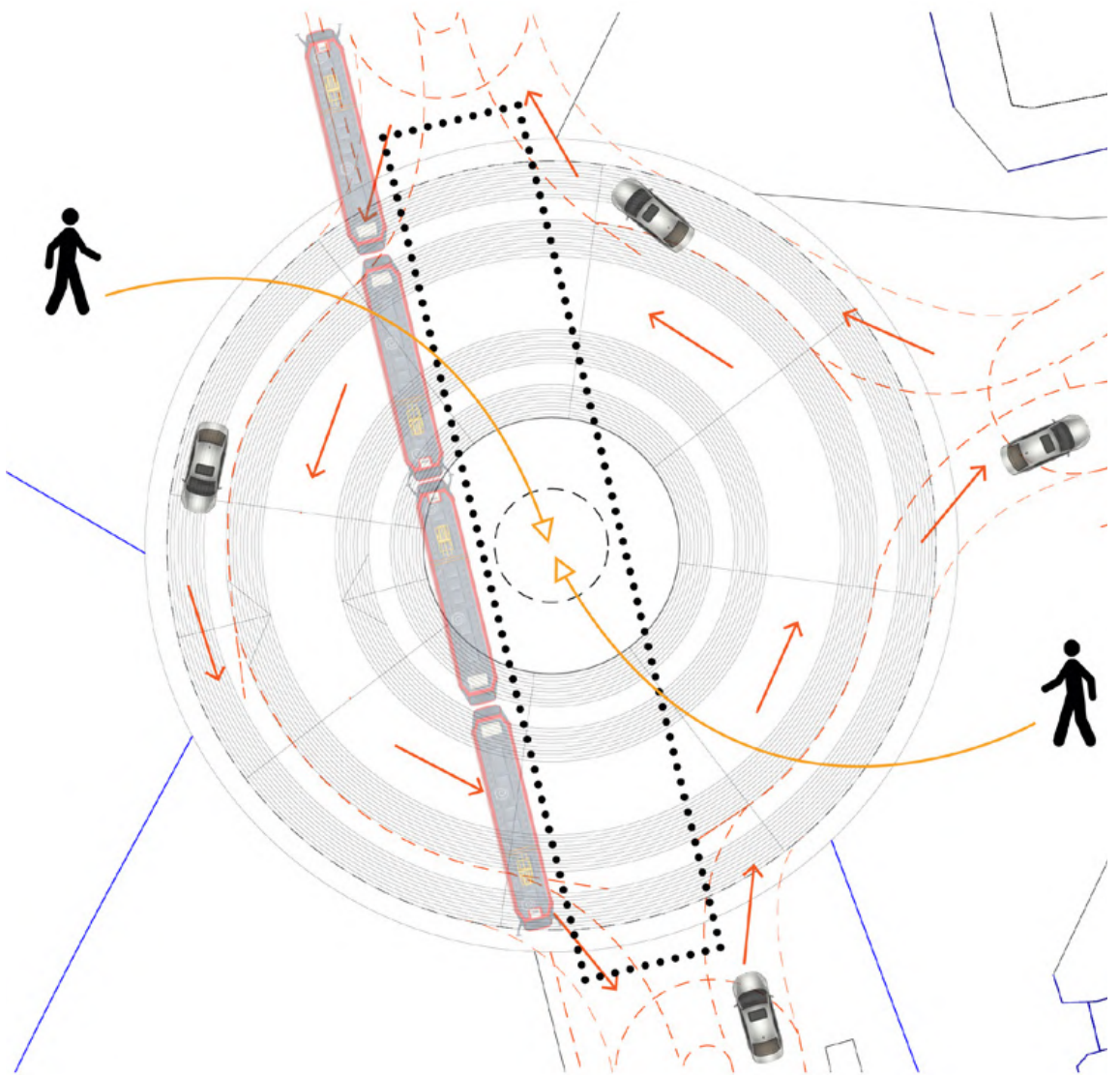

Dispersing Program

Following the physical model for the development of the station, presented at the beginning of the conceptual phase, we established a plan expressing the de-constructive “explosion”, which embodies a non-priority-direction approach to the station.

The perfect circle of the station, in order to break its radical monotony, has been broken by the free forms hosting a variety of leisure functions such as a skate park, a children playground, a big slide, communal gardening and a public performance stage. These functions are chosen to activate the area for visitors as well as the surrounding community, further enhancing the mixed development.

Furthermore, the green belts invade the cone surface as an extension and representation of the natural qualities of Kralingse Bos. The belts also provide guidance, which is not to be mistaken for direction.

Overall, the aboveground design decisions aim to emphasize the gradual “blending” of the entire station with the bordering landscape and all other urban scale functions, that have been previously envisioned in the urban development phase.

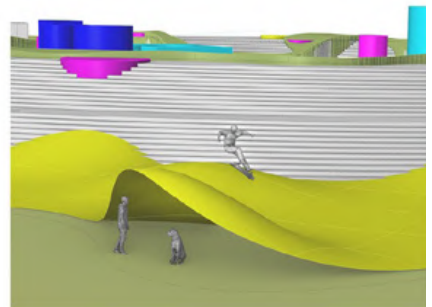
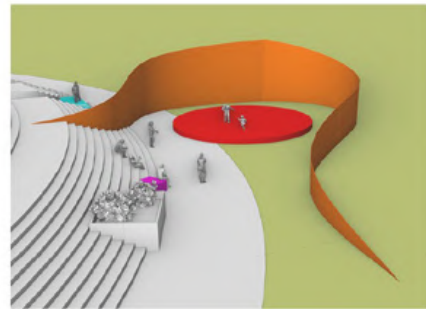
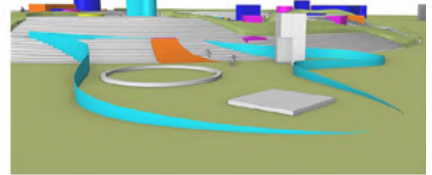
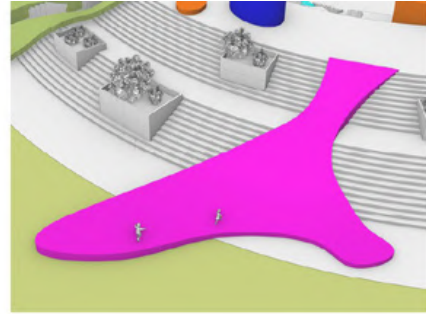

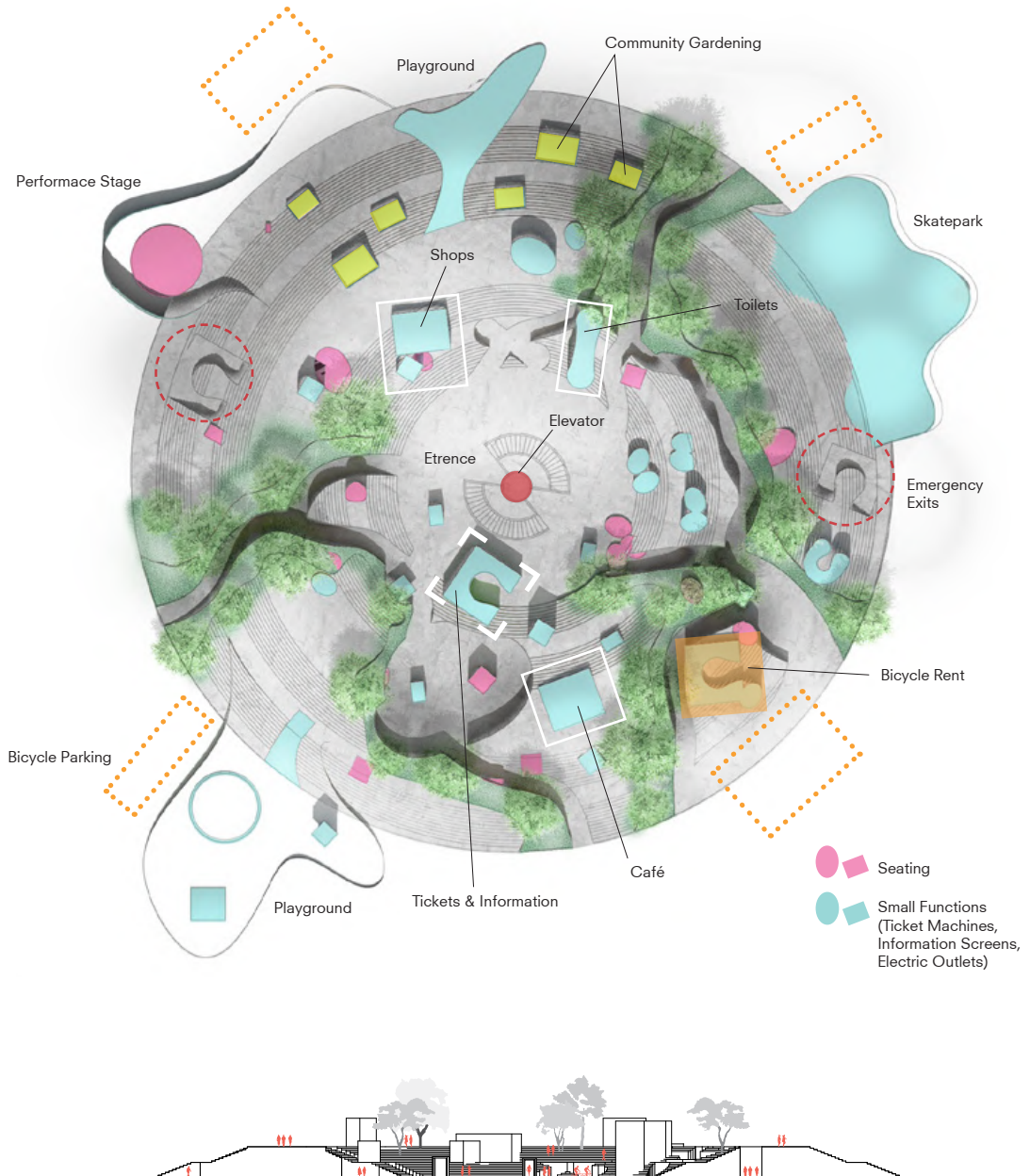

Plan & Section of Cone

Material Concept & Atmosphere

While dispersing program like confetti all over the urban scale, the cone landscape (down into the metro station itself) which approaches the design from it's material and surface point of view aims 1) to create a cohesive surface treatment that will allow all expressive elements to become one station, 2) to be loyal to the cone's identity as a landscape and the stations identity as a cave and 3) use materials to emphasize on the separation between surface and object.

Referring to the classical element of a Colosseum in its form, the cone will be paved with yellow sandstone. It gives the cone its own identity next to the topography of Kralingse Bos, rather than numbing its visual presence in darker pavement. The only differentiation happens where the incisions to the cone lead to the centre, allowing orientation through brick pavement, as a transitory colour between the world outside and the world within the cone. Those incisions are held up by curved walls of weathering steel, which as vertical, functional elements, create bridges to connect all part of the top ring of the cone.

Arriving on the intermediary platform and on the train platform it becomes clear that the choice of natural stone serves to represent unison of all spaces while allowing each level to be its own sub world. A stone surface will immediately relate to the identity of the locus as an excavated space. Being the container of activity, the intermediary "Kiss and Ride" platform, paved in red sandstone invigorates through function a colour. Descending onto the train platform a dark stone covers all surfaces, seemingly fusing train tunnels with their space of arrival and departure.

The curtain of weathering steel becomes a reference to the cone's incisions. As a space consuming sculpture it relates more to being an object than to being a surface. This approach is also taken in choosing a surface for all shapes that hold functions on the cone and on the intermediary platform. They deviate into being "placed objects" rather than landscape elements, represented by colourful metal surfaces.

The roof and the elevator shaft consist of glass and mirror panes, creating a beam of light and reflections. Playful and bright it invites passengers to gaze at it against the stations raw concrete ceilings.

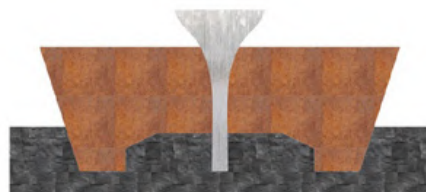



REToilet - Accessible Public Restrooms Cone Plaza

Most amenities and functions around metro hubs will be obvious: commerce, information, ticket sales. One neglected component is the public toilet. Whether as locals or visitors, we constantly find ourselves in cities going from A to B with a lack of access to one of our most basic human needs. That thought only arises when the individual need does and when satisfied it becomes irrelevant once again. Public toilets are scarce in urban environments leading to the abuse of restaurant bathrooms, often to the discomfort of business owners. This small-scale design aims to establish a new icon within the context of metro station designs. Like elevators and escalators for accessibility, car and bicycle parking for mobility or even mobile AEDs for health emergencies, REToilet serves to establish the necessity of a public rest room to all future metro hubs. The station is to be identified as the nearest option for a rest room, like a gas station would be as the next option for petrol. Considering the context Kralingse Bos, a wide recreational forest, attracting hundreds of visitors a day during summer, the need seems even bigger.

REToilet, run by Rotterdam's metro company combines public transportation with public rest rooms. The need for cash or even a credit card becomes obsolete. Anyone in possession of an OV-Chipcard can log in and out of the rest room. Like any distance travelled by tram, train or metro, each use is charged to the holder's account. Even anonymous chip cards, loaded with enough cash are applicable. Users with disabilities in need of easy access of public rest rooms, can register and their card will give them unrestricted free access across the entire Metro system of Rotterdam. This way public toilets even become means to counter social issues like accessibility for physically impaired.

REToilet - Constructive Identity

In line with the concept of confetti dispersed over a landscape, the identity of all built amenities contrasts with the landscape they landed on. Mass and uniformity with the landscape are within the cone, fragility and a sense of "being misplaced" or "fallen objects" is represented through construction and material of the pavilions. Like walking into your backyard and finding a shed that doesn't seem to match the house it belongs to, but it is yet dear because it holds all tools for maintaining your favourite place – the garden. Simple as the shed, the pavilions are built in a bigger scale with a steel beam construction, visible on the inside to emphasis the atmosphere of walking into a can of paint. Colourful corrugated sheeting separates all amenities monochromatically and enhances the sense of orientation upon arrival at the station.

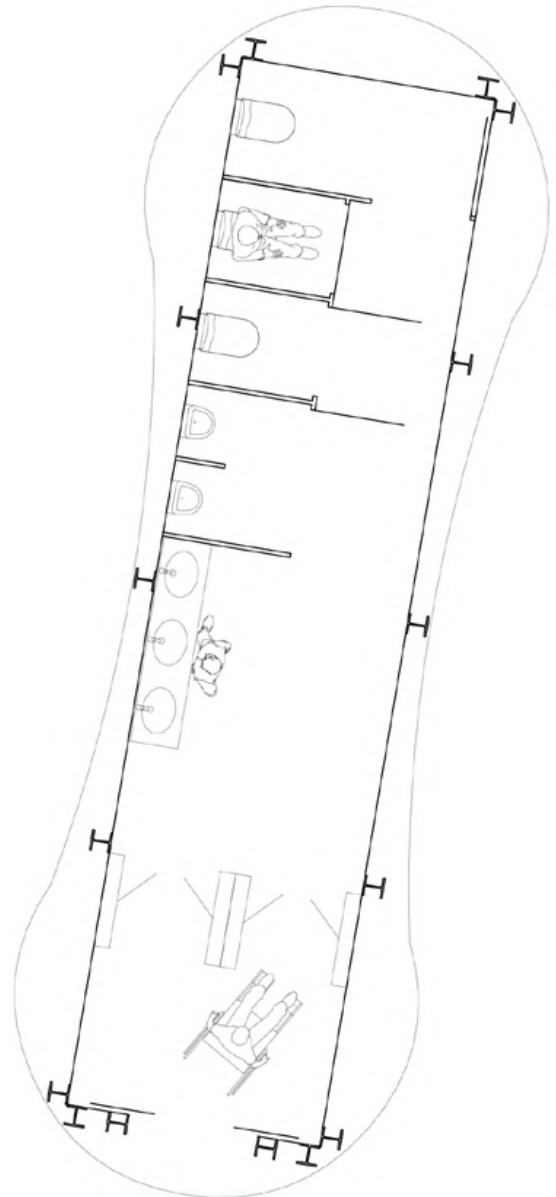

Floor Plan



 ov-chipkaart



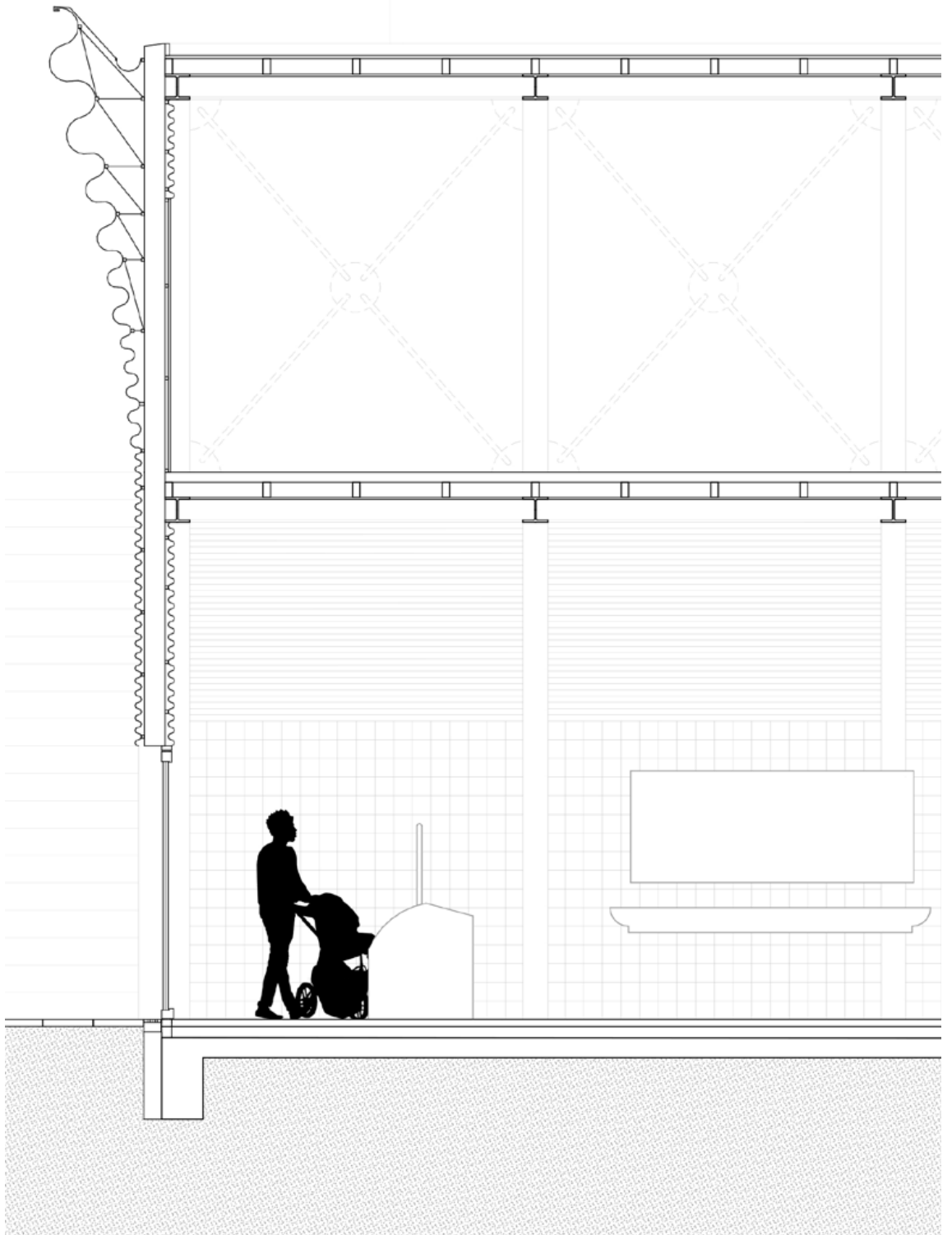

Section
1 : 50

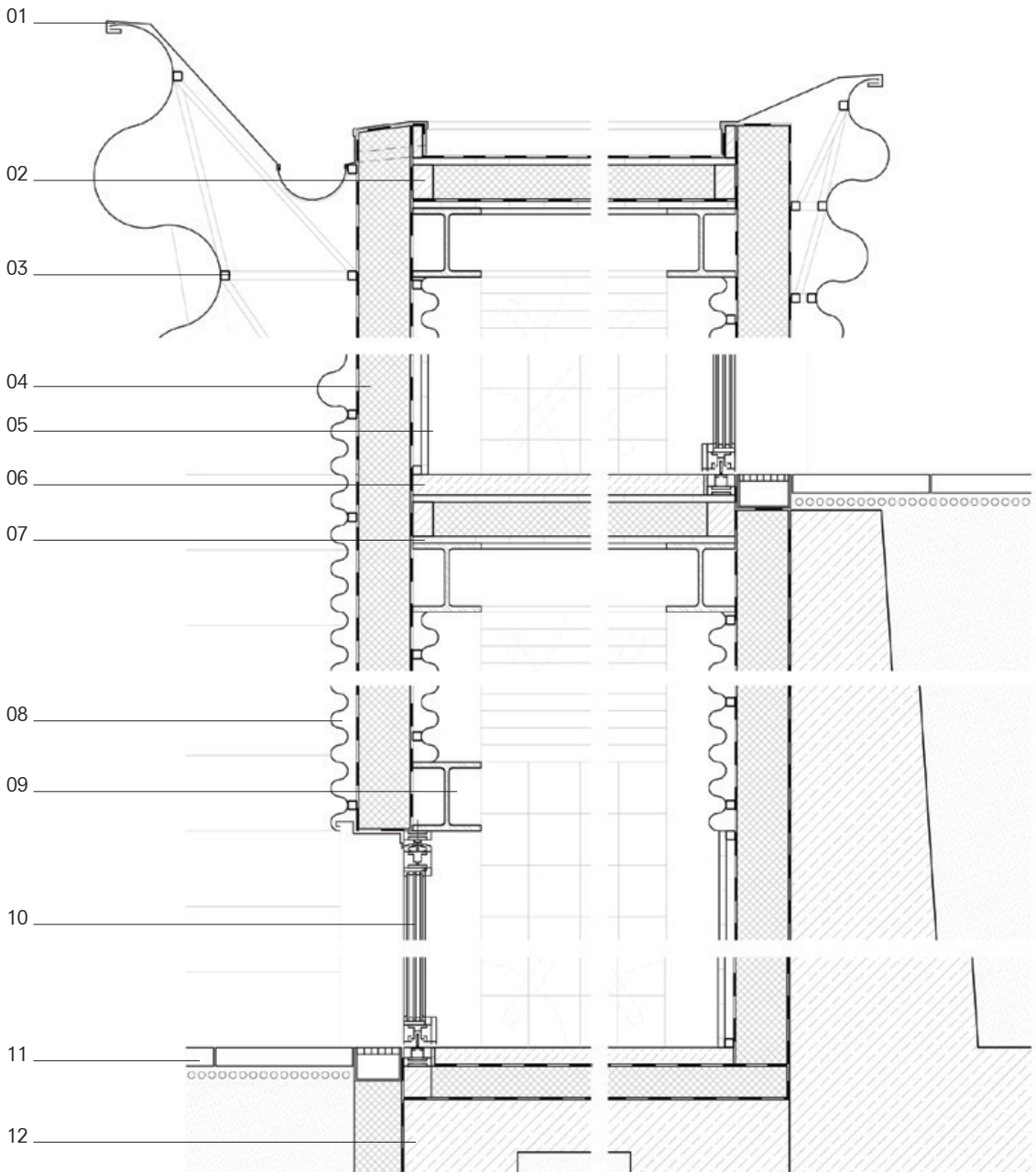

Construction Detail REToilet

1 : 20

01	1 mm sheet-zinc covering	07	20 mm plywood
02	10/6 mm batten floor construction	08	18 mm corrugated steel sheeting
03	25/25 mm steel SHS	09	door frame: steel I-section 200 mm
04	150 mm rigid-foam insulation	10	slide door: aluminum frame with tripple glazing
05	20 mm plywood; 15/15 mm tiles	11	400/400/50 mm sandstone
06	60 mm screed	12	200 mm reinforced-concrete floor

Roof & Entrance Zone

The Explosion of Functional Matter

Entrance Zone

Positioned in the heart of the plaza, the roofed entrance zone allows new-arrived users to smoothly “immerse” in the underground of the station either by entering the elevator in the very centre of the complex or using one of two contrariwise oriented escalators that lead towards the concourse platform.

Transition

When arriving at the “Bos” station’s platform, a user is being gradually faced with a variety of architectural forms and colours. Going up on the elevator, this notion steadily amplifies itself, reaching culmination dramatically when arriving at the ground level of the station’s plaza. Integrating an elevator and the roof in one compact architectural gesture that smoothly leads from the underground up to the very centre of the complex embodies a natural transition that consequently introduces arriving user to the diversity of the on-ground program.

Eruptive nature of the “mushroom”

Effectively, the silhouette of the “mushroom” metaphorically embodies the explosion of the new amenities that arrives at the Bos area and land immersed in the neo-classical “substance-vague” of the cone. This refers also to the urban scale, as the station is expected to trigger the development of the whole urban area by disseminating the mixture of functions that currently is not enough present (see the introduction of the booklet). Thanks to the considerably meaningful formal representation, the central “mushroom”, that protrudes from the cone’s silhouette will serve as a landmark, characteristic element giving identity to the newly developed Bos area. Its metaphorical matter represents a powerful influence on the neighbourhood that the whole station is expected to finally perform.

Towards well-being and nature

Finally, still being situated at the recreation&sport oriented area, the “mushroom” as an element of the entire station, continues introducing into nature-based well-being and healthy environmentally-responsible lifestyle, also in technical measures. Thanks to its optimal shape, the “mushroom” is able to collect both energy from the sun (with the use of PV-glass panels) as well as the rainwater. Apart from the roof itself, the rainwater-collection system is being extended to the whole area of the plaza.

Entrance Zone
"The Mushroom"

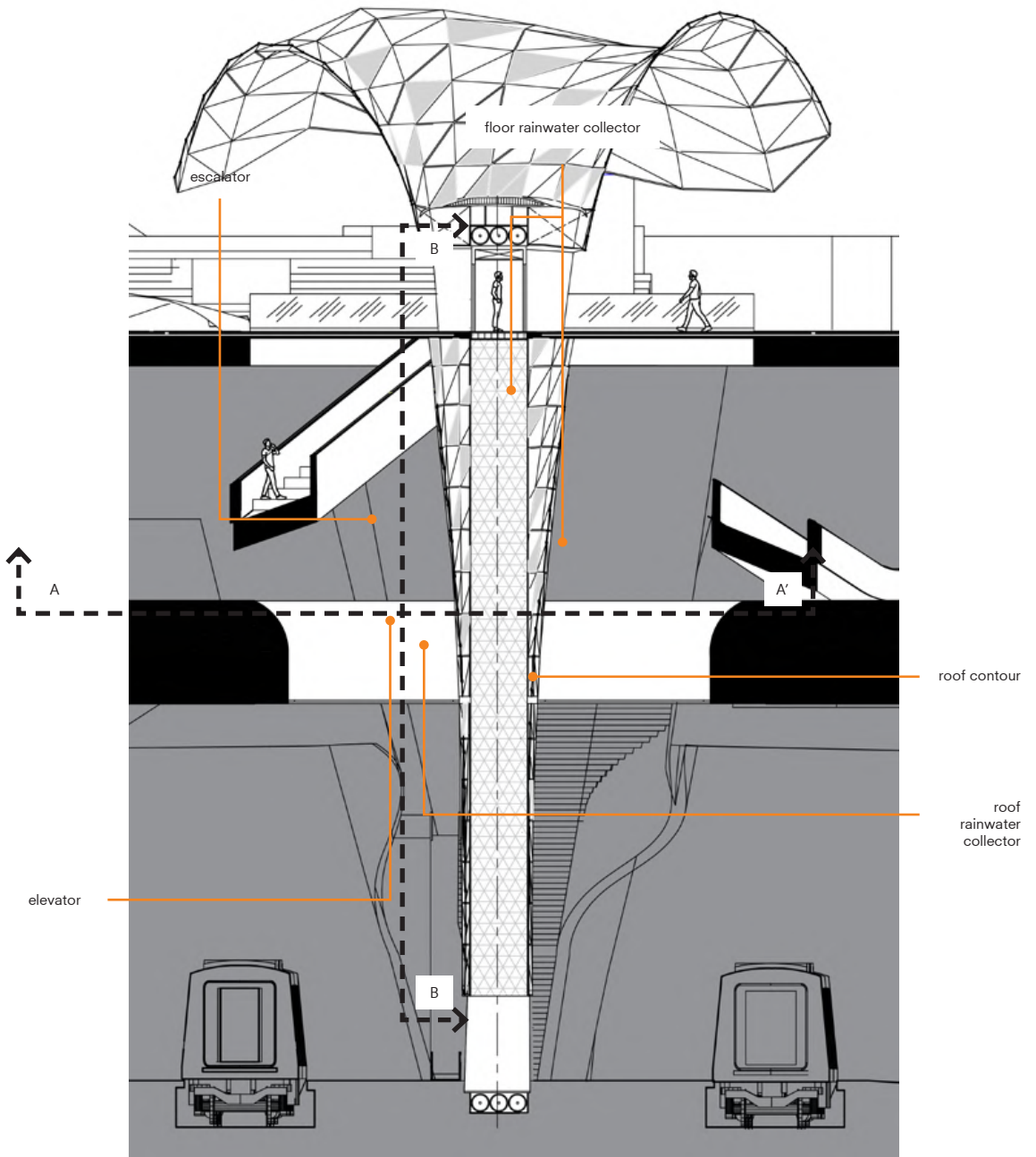

The "Mushroom"
Section A-A'

The Roof & Entrance Zone

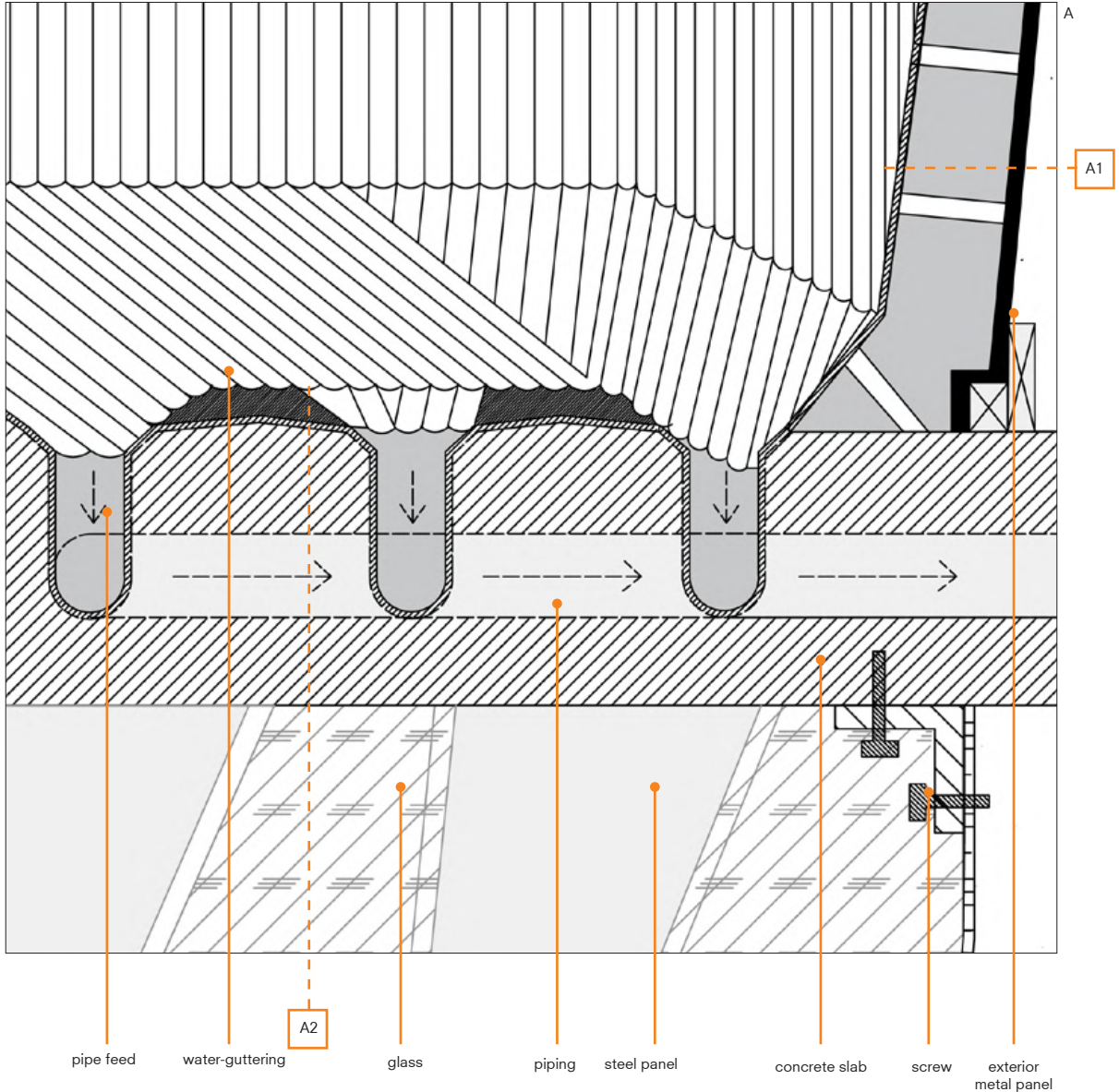

Built-in Rainwater Collector Detail
1 : 5

- A1**
- 01 exterior metal panel 12mm
 - 02 cavity / mounting grill 70mm
 - 03 corrugated iron as water channelling gutters 5mm

- A2**
- 01 reinforced concrete slab 200mm
 - 02 pipe r30mm
 - 03 cavity / grill 22mm
 - 04 corrugated iron as water channelling gutters 5mm



Underground Station Concourse & Platform

By tearing the traffic roads apart, an underground concourse emerges.

In contrast to the cone plaza, the kiss & ride on both sides is the car-users' first stop to this metro station. The floor plate, an 'eye' shape is derived as a 'compromise' between the cone above and the platform below. The transition from a sphere into a rectilinear block is justified with this gradual opening.

This 'wound', this 'void', this spatial absence creates also a visual dialogue across the three main levels, allowing all vertical elements of a station to be wrapped around a central spine.

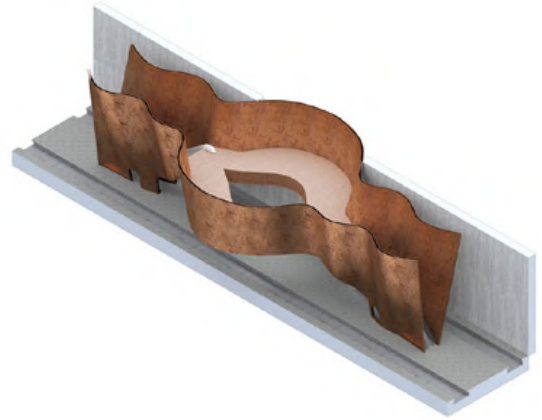

Concourse Level Isometric

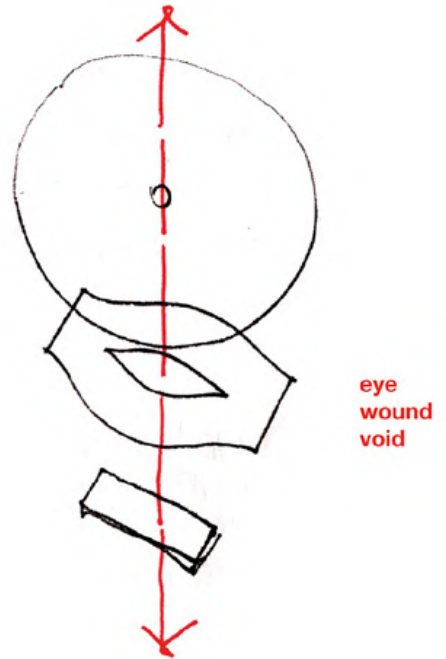
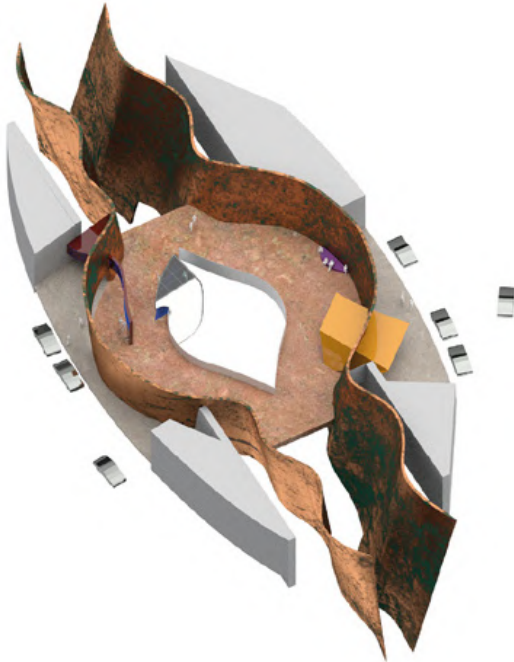

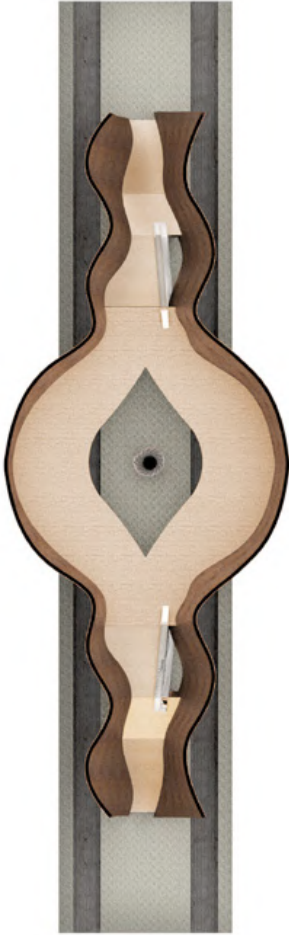

The Confetti Amenities Concourse

A cave-like atmosphere defined by the red stone floor and weathering steel walls - the resonance of being underground, as if you were inside a whale's stomach and then, as if a ship had docked inside the whale's stomach.

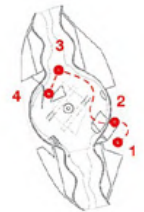
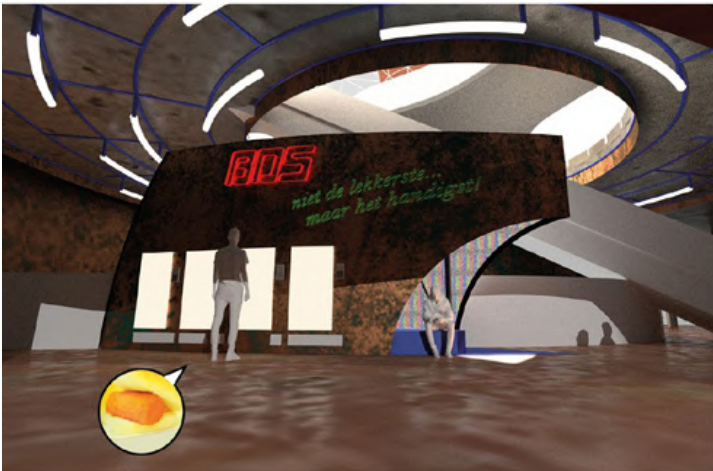
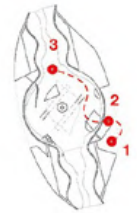
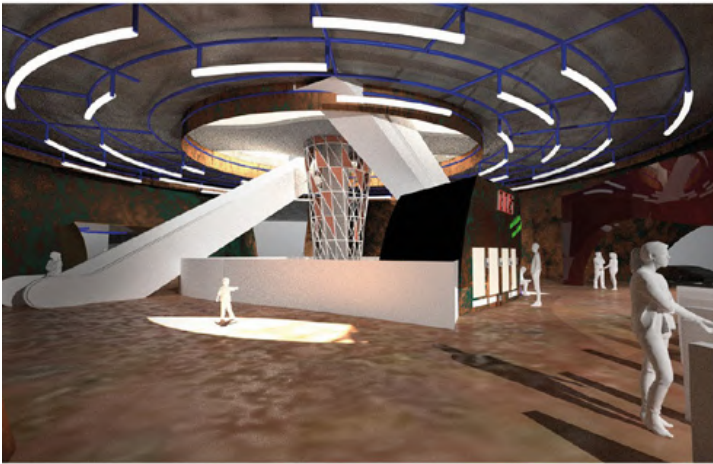

Reference
Febo Convenient Eatery



The Confetti Amenities

Confetti Kiosk

This is one of the few amenities that were transformed from confetti - becoming kiss & ride gates, ticketing machines, seating and the 'confetti kiosk'.

It's a perplexed mix of physical and virtual needs. One side is a weathering steel finish housing vending machines, the other is an LED screen - a peculiar shape extending into the central void. The transparency allows viewing from both sides: upside-down art, inside-out news, and self-inflicting ads.

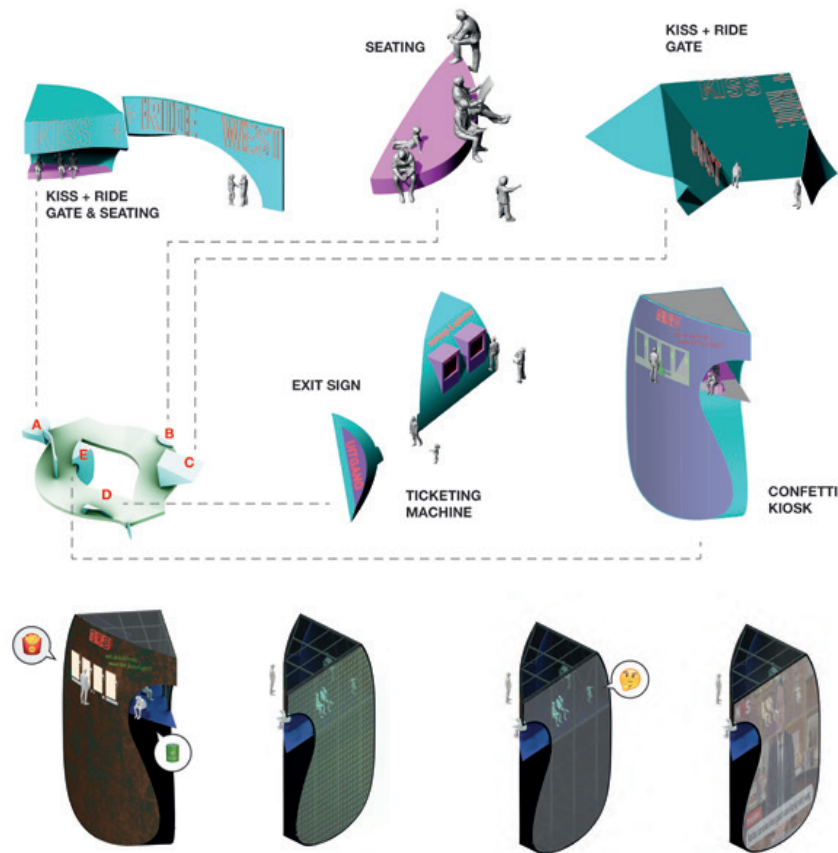

Reference
Diller Scofidio+Renfro,
Brasserie, 2000

Reference
OMA, Zentrum für Kunst und
Medientechnologie, 1989

Reference
The 40 metre screen at
Rotterdam Central



Curtain Platform

The station, underground and the cone, above ground were in the weeks prior to this final product two different concepts. The station has to be functional while above ground, this is not the main priority. As people walk through the cone they are non-directionally guided by the weathering steel pathways. Disorientation comes into play as your view is obstructed by the curved paths. Until you arrive at the centre plaza that instantly indicates an entrance to below ground. The final result of the station works in a similar way. Curved paths lead to upstairs where people can live their non-directional lives. The curtain encloses the curved paths. The curtain guides the visitor quite clearly to one direction, the cone. Along this route it provides the essence and spatial ambiance of what can be perceived above ground, acting as an introduction, while ascending, or a final goodbye, while descending. As the station has to be functional circulation is distributed over the full length of the platform.

The curtain forms a 'V' in section that indicates a direction upwards. The pedestrian is subtly guided towards the concourse. Light emits from the oculus onto the station and the platform is only partly seen from within the curtain. While the visitor moves from the concourse to the platform, two instances occur where the platform is partly shown; focusing the awareness of the visitor to the spatial ambiance instead of the pure functional station.

The curtain is thus of a functional kind in the way the station is perceived and how it guides you. However, because of the construction involved, the curtain has a thickness that can be used. The width is the ideal dimension for seating.

Additionally, when standing on the platform, the curtain acts as a barrier between the two metro tracks. The construction allows to puncture the curtain in a way seating and visibility combined become a kind of 'burrow' or 'shelter'. The curtain in this way becomes also functional on a human scale.

In order to design the burrows, models were made out of gypsum. As the models themselves did not show how they would be used, characters are implanted that tell the story of a traveller waiting for the metro.





Staircase View
Illustration



Platform Level "Burrow"
Illustration



The curtain contains double curved geometry. In order to hang the weathering steel panels, a dynamic construction is needed. A mesh of steel beams is chosen to provide the curved structure. This structure is attached to the roof, concourse and platform from which the foundation of concrete is used as a steady medium to relieve the structure from the vertical forces at play.

The two staircase landings act as a stabilizer of horizontal forces along with 4 pull cables. The landing is fitted with 2 beams and a concrete floor that distributes the force evenly.

The staircase has its own curved beam that is attached from the concourse to the staircase landing to the platform. This is to subtract the forces of the staircase and the crowd that walks over it from the forces that are at play in the curtain structure.

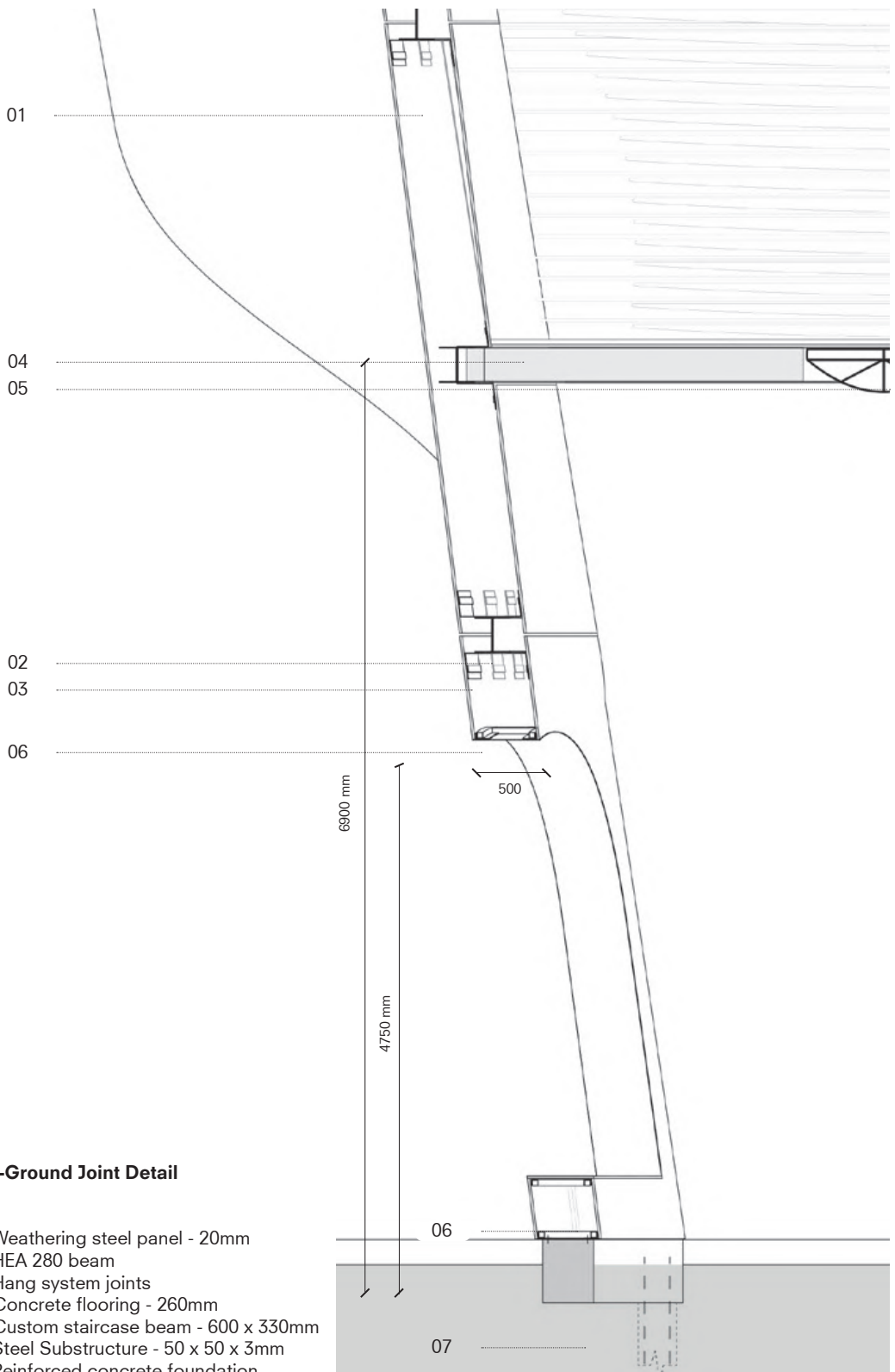

**Curtain-to-Ground Joint Detail
1 : 50**

- 01 Weathering steel panel - 20mm
- 02 HEA 280 beam
- 03 Hang system joints
- 04 Concrete flooring - 260mm
- 05 Custom staircase beam - 600 x 330mm
- 06 Steel Substructure - 50 x 50 x 3mm
- 07 Reinforced concrete foundation



Light at the end of the Tunnel

Bos Station
Concentrate!

Izk Chan
Tamas Dongo
Wessel Herrewijnen

“Hyper-Sports” Concept Summary

The Bos metro station will be situated in the Oostflank area of Rotterdam. A unique part at the outer borders of Rotterdam, close to Kralingse Bos: the biggest park and green recreation area in the city. Apart from connecting both the neighbourhoods Het Lage Land and Prinsenland to the Metro Network of the city, the location of the station also improves the connection with the rich collection of sporting clubs and fields that lie directly between the park and the neighbourhoods Het Lage Land and Prinsenland. The scheme promotes sport activities for a healthy living. It is especially important in the technology driven future. These sporting facilities are a dominating quality in the area, not only servicing the inhabitants living in the direct surroundings, but in fact the entirety of Rotterdam. This presence is therefore a unique selling point of the location.

The area between the ‘Boszoom’ and A16 Highway is selected by the city of Rotterdam as a potential location for creating up to as much as 12.000 new housing units. This means that (parts of) the area directly surrounding the new station will also have to cater in this urban development. The municipality of Rotterdam focuses on creating a balanced blend of different typologies when designing new neighbourhoods or urban developments. Vacant areas in Het Lage Land and Prinsenland will mostly be used for housing ground bound typologies such as for (young) families (which are valued greatly by the municipality). Densification will happen mostly in existing neighbourhood structures, where apartment blocks and towers can facilitate in the need for (high income) apartments, housing for the elderly and more.

Because the Kralingse Bos is a protected area, the character of this ‘neighbourhood’ will remain as it is, not playing a big (if any) part in fulfilling the need for housing. The park will however see a rise in ‘use’ as there will be a large number of new inhabitants added to the area, as well as a metro station that will increase the connection to the park for the rest of Rotterdam.

Both sports and the appreciation of green areas in the city are important focusses for the municipality of Rotterdam in the process of urban development. As mentioned before, both these qualities are already present in a for Rotterdam unusual high amount in the area. The new metro connection is a perfect opportunity to further connect, improve and further improve these two assets. Especially because, while the area might have one of the highest densities of sport related functions of the city, the facilities present have been subject to the test of time and might not be ‘up to date’ anymore.

The metro station is both a connecting element for (new) inhabitants to and from work/the city centre, as well as a means to increase accessibility for the recreational values of both the Kralingse Bos as the sporting facilities for inhabitants all over Rotterdam.

The presence of a new metro station has the beneficial effect of attracting other companies and amenities to an area. The amount of new housing will make it easier and necessary for these functions to settle and be viable.

Building on the present qualities of green and sports, the area can become a more active and connected part of Rotterdam, making the area the main sporting hub of Rotterdam where sporting and recreation in a green environment come together. The strip surrounding Station Bos will become the sporting hub of Rotterdam, while simultaneously being the gateway to Kralingse Bos and the connection between inhabitants and the city centre.

Developing this area as the new ‘hyper sporting hub’ of Rotterdam means that the current structure of the strip must be improved and revised. Sports are seen by the municipality as an important means to increase interaction between people in the city. Whereas now the strip is dominated by private or temporarily accessible sporting clubs, which not necessarily make for good connection or interaction in the area, the area must be broken open, blending high quality sporting organisations with freely accessible open space where people can do ‘free’ sports and activities. Other amenities associated with the different sporting facilities will be added to the area, in order to cater for all the different needs of users, making the area into the sports and green recreation area of the city.

The Metro station must facilitate this movement, bringing inhabitants from and to the centre as well as connecting the city and the area to the new hyper sports area of the city. The station must therefore both be designed with amenities for work traffic, as well as giving space and easy access to the area for visitors who come to use the sporting facilities and the recreational qualities of the park.

For the exact location of the station, this means that it is focussing on being the main focal point in the sporting strip: located in the centre of the area, being in the middle of urban neighbourhoods, the park and in the centre of the new ‘Bos’ sporting hub.

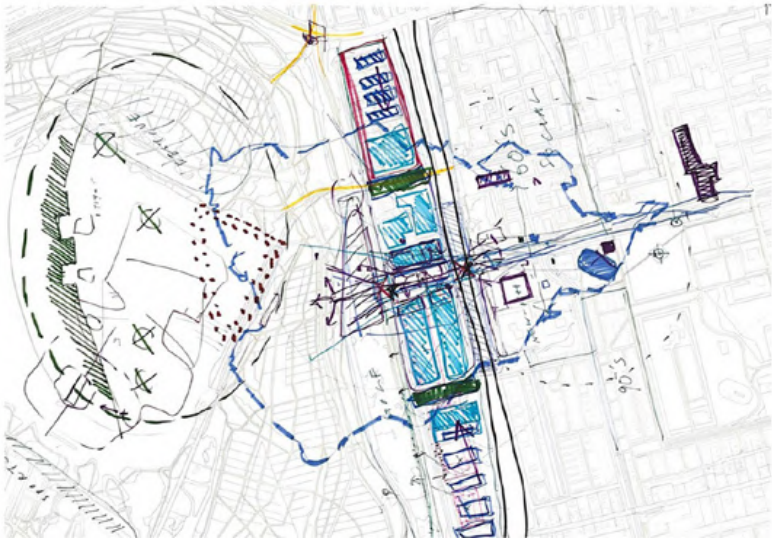
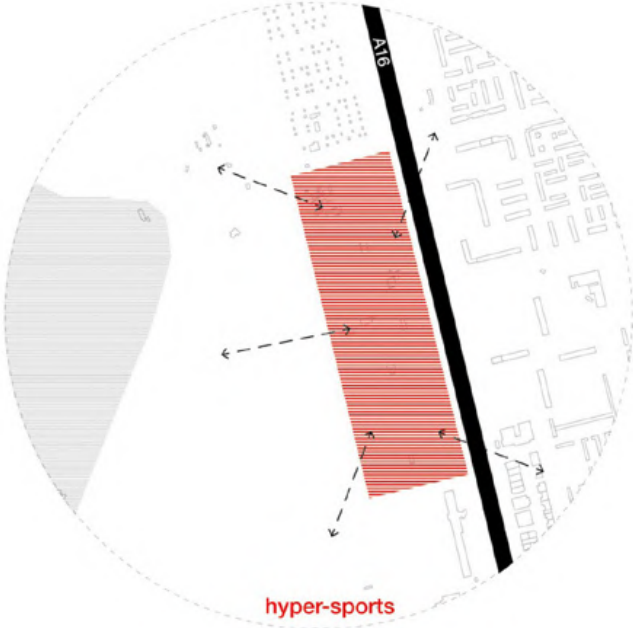

Station Bos

Focus

The metro station Bos is going to form a link in this development. The station will equally serve the existing neighbourhoods of Prinsenland and Het Lage Land, as well as the new housing that will be added to the 'stripe' by connecting them to the rest of the city. The A16 highway that is currently a big obstacle in the connection between these areas is a focal point in the development of the Metro Station and the area as a whole. Directly next to the highway, there is currently a large portion of unused and vacant undefined land that can easily be used for large housing blocks or towers. Projects like Funenpark in Amsterdam show that such housing typologies can be successful when placed next to a highway.

The Bos Station will be situated in the middle of the two main areas it will be serving: the underpass at Prinsenlaan under the A16 highway is currently one of the few connections between these two areas, while at the same time being a very dark and unpleasant area for all sorts of traffic, especially pedestrians and cyclist. By putting the station on this very location, under the underpass, the station will be positioned on the exact node, while also seeking to improve the public space that is currently of insufficient quality.

The four lanes of car road will be reduced to two, underneath the underpass, resulting in more space for the station, for both pedestrians and cyclists.

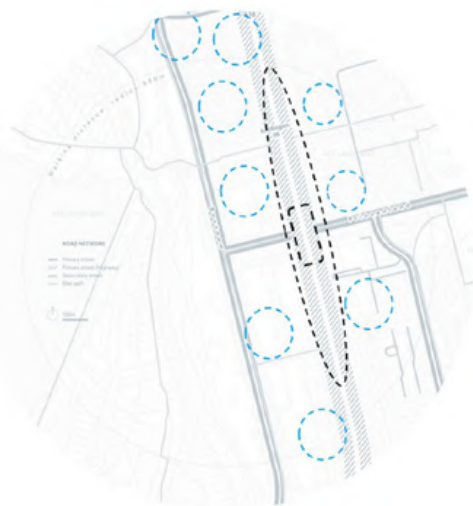

Location of Station Bos will be surrounded by new housing, both directly around the highway, as well as in the new neighbourhood and the existing ones.

A Node of Contradictions

Access

Both the station as the area the station will be serving are examples of contradictions. The 'stripe' left to the highway will go from zero housing to a dense neighbourhood with mixed typologies, forming yet another contradiction between urban space and green recreation space (namely Kralingse Bos).

The station is, even more, a point of contradictions: it is simultaneously the main connection node but also an unpleasant space to stay. There's the contradiction between light and dark, the concrete and the almost Brutalist design of the underpass and the softness of nature.

These contradicting themes form both the strong assets as well as the problems of the underpass. The existing qualities of light and dark, location, materialisation, traffic, location and the existing characteristics of the underpass play a leading role in the design of the Metro Station. Not using such conditions would lead to an inconsiderate design, neglecting the place and its strengths.

As discussed, the underpass and the station will become the central node and meeting spot connecting the two neighbourhoods. Where this area is now an unpleasant place for pedestrians and other traffic forms alike, the underpass must become a pleasant public space, making use of the existing strengths of material, shelter, size and light/darkness. The traffic flows will be improved and extended. The metro station will become part of this public space, the two entrances going down to the platforms are designed in a minimalistic way, and therefore not becoming a standalone object in the surrounding public life.

Here the play of light and darkness during the day and night is taken into account, both in the station as the public space directly surrounding it.

In 2040, as electric cars become popular, the highway is expected to transform into a green highway that generate minimal environmental impacts in the highway environment. The station is proposed in the underpass and aims to make the most of these spaces.

In order to achieve that, the space under the highway is opened with further excavation to increase underpass headroom. It is connected by a gentle sloping landscape design which also serves as leisure spaces.



Concept Collage

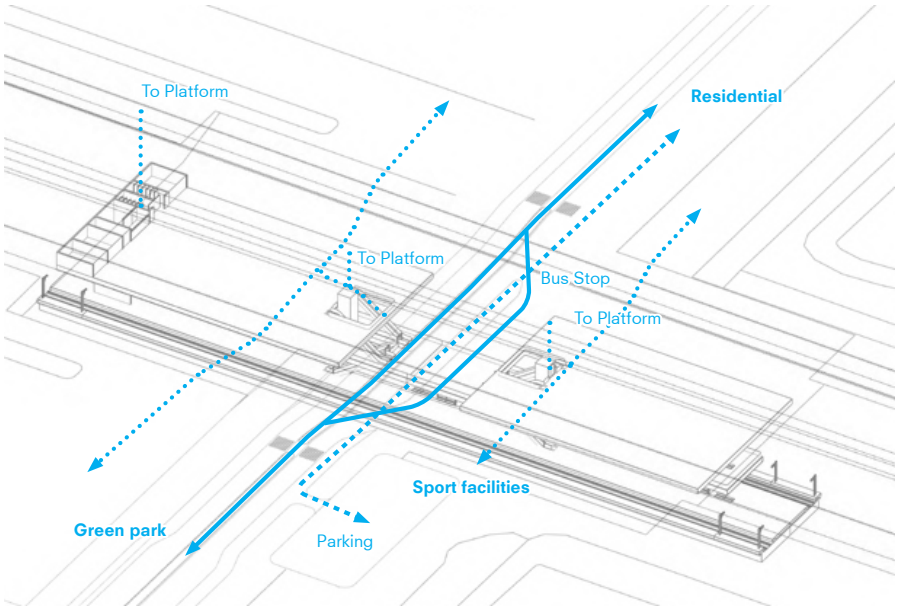

A Node of Contradictions

Organisation

The underpass itself remains a relatively modest or almost hidden location for a station. The design for the station on the outside therefore is playing with this reality, using the same materialisation as the station, but also using the theme of contradictions. A set of letters spelling out 'Metro Station Bos' is in place over the entire length of the underpass, 'extroverting the introvert location', emanating a soft glow during the night.

The surrounding square with grassy slope should make for an active hub were people would also spend time outside the function of a Metro Station.



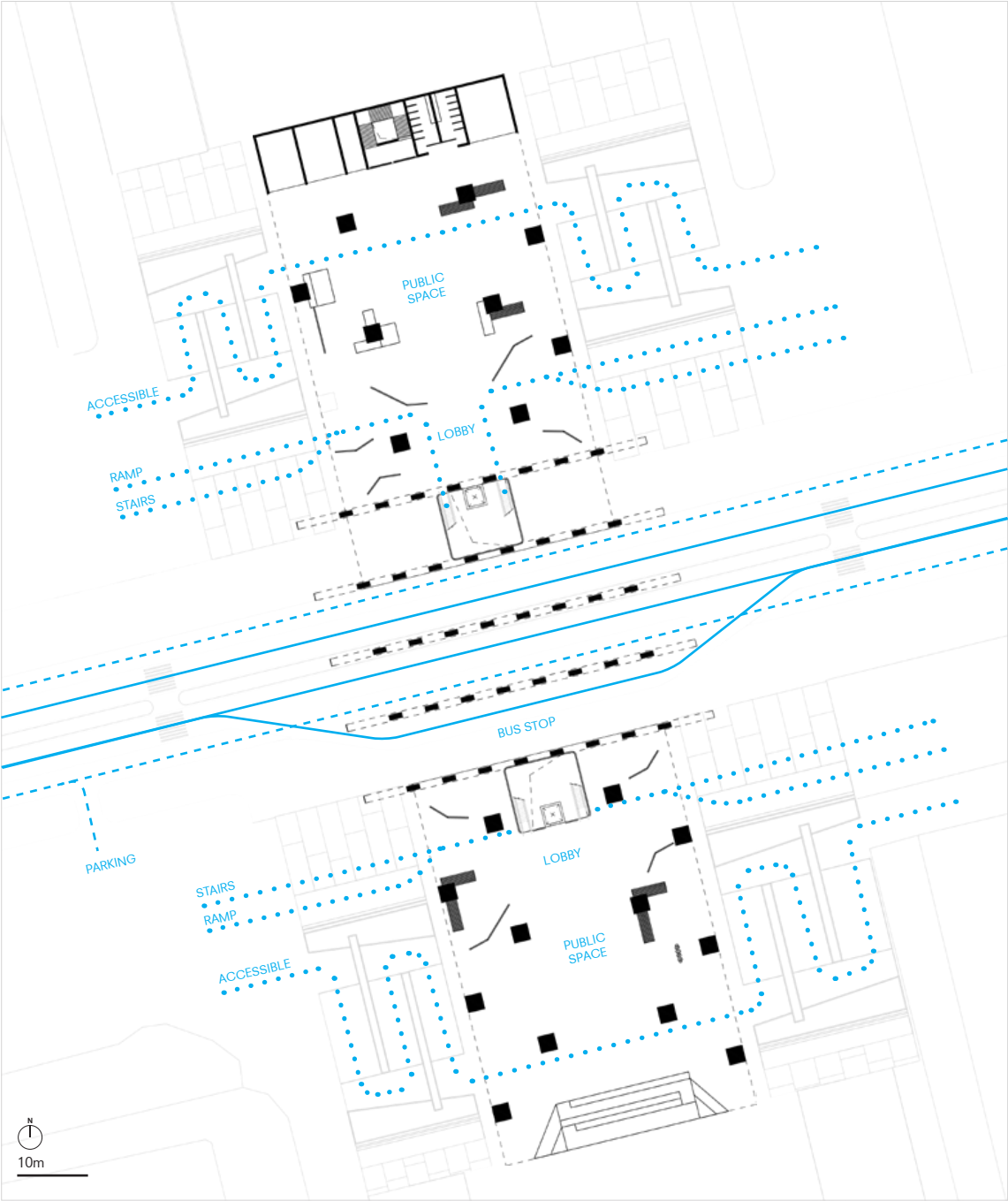

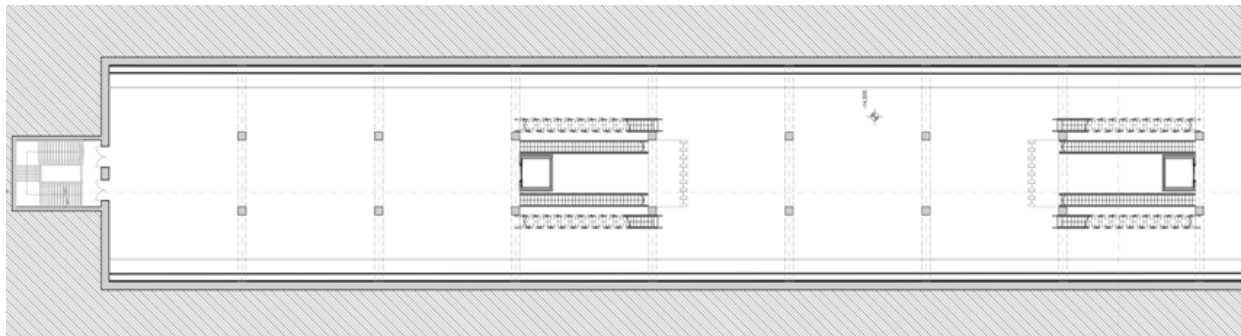
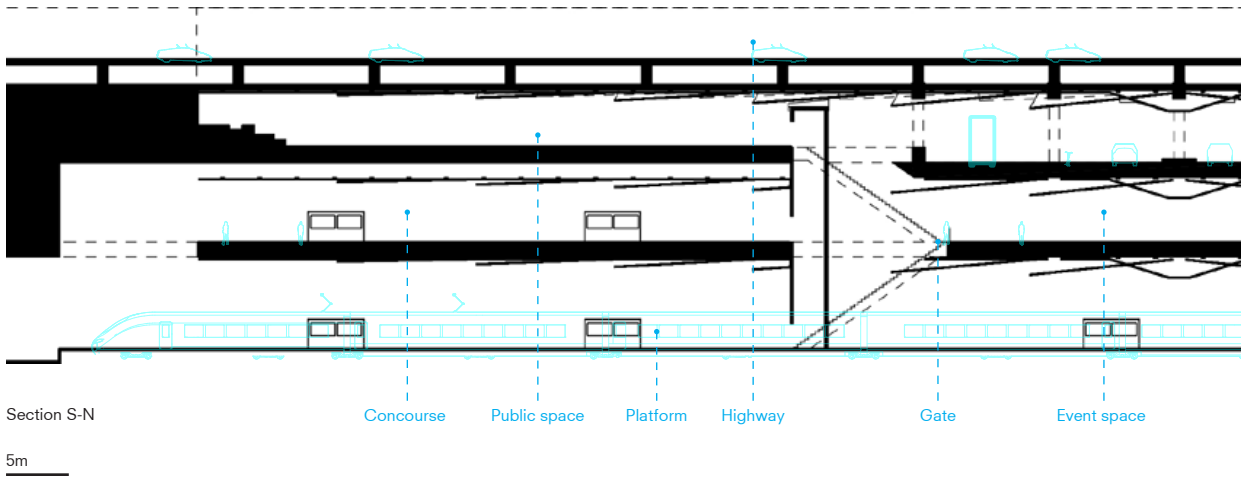
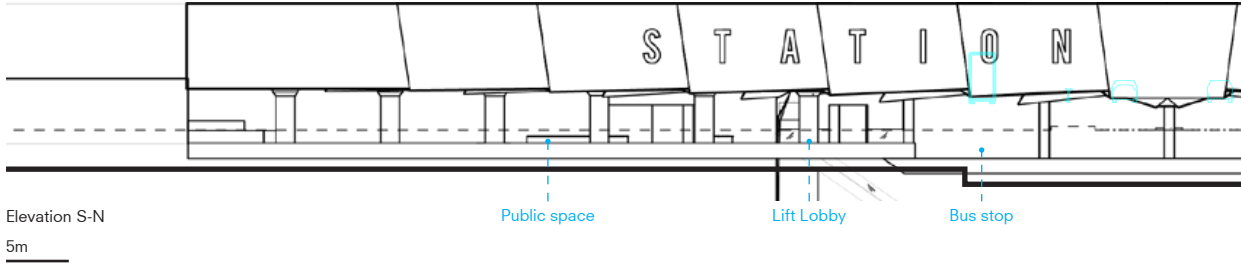

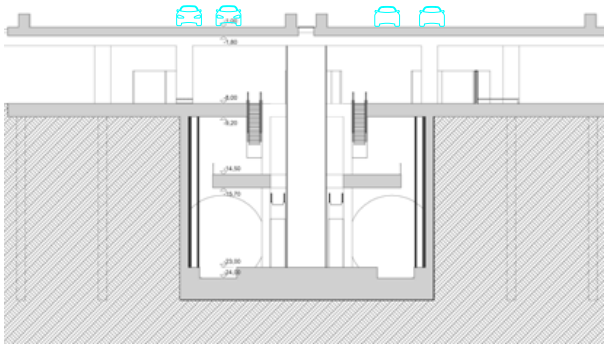
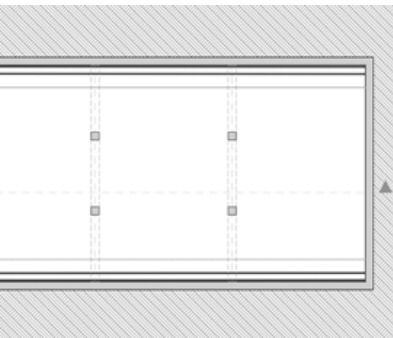
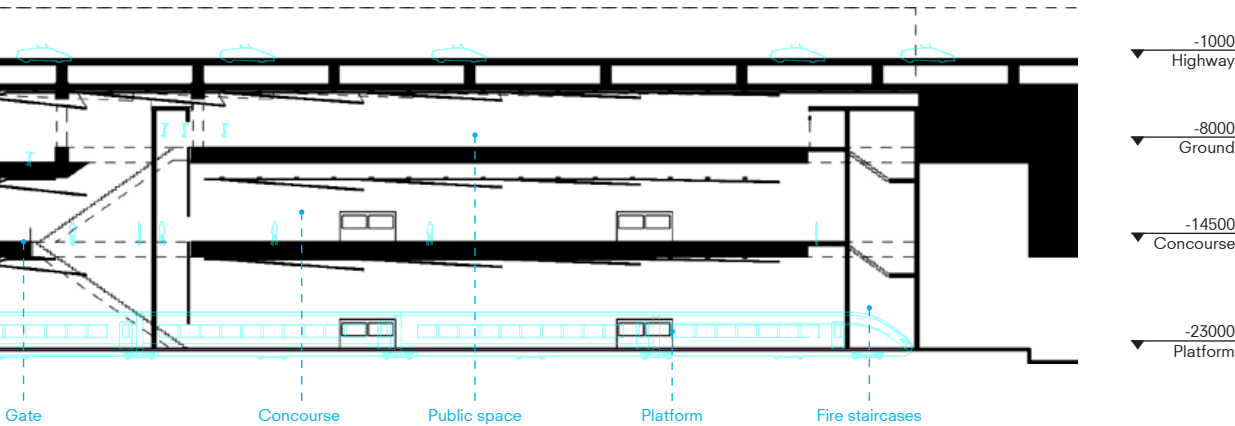
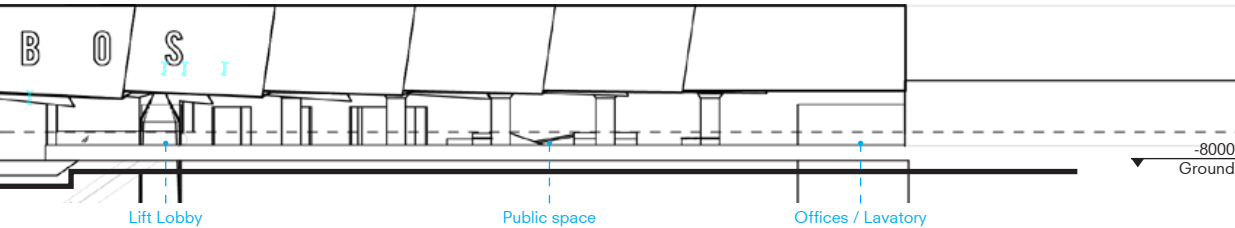

Station Section

Interface between Spaces From Spatial Strategy to Form

The design started by analysing the routes of different streams of mobility. The circulation between the concourse, platform, public space and neighbourhoods are developed based on the understanding of the positioning of the station. Metro station serves as a transportation hubs. Beside the train, other transports such as buses, cars and vehicles are necessary to enhance mobilities and extend the travel distances. For this reason, road and public transportation are also alternated to provide better supports for the users.

The location and criteria of the interfaces have been identified from the planned routes. The major architectural designs of interfaces include the entrance, the entry slope, the escalator lobby and the platforms.

The permeability and ventilation are increased by opening space under the flyover. Instead of building new entrance from the ground, a U-shaped facade is designed to enfold from the side of the highway to introduce the connection into the station down to the platform. Illumination is integrated to generate a welcoming atmosphere from external to internal space. This architectural language is continuing to further extend and become the ceiling. The bi-directional weaving form acts as a visual guide and enhances the connection on the two sides.

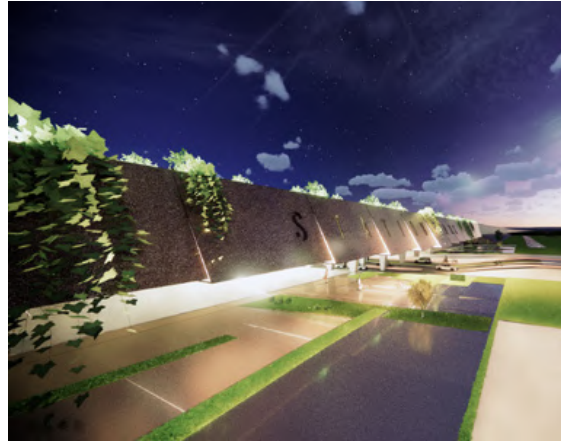

Exterior View
Illustration

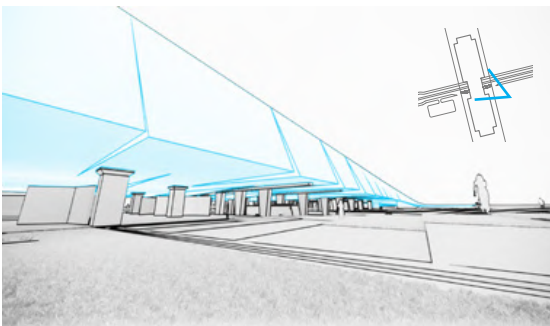

Spatial relationship between highway and station

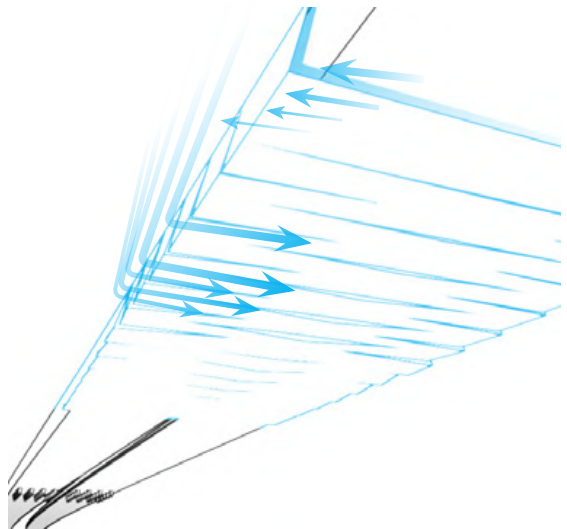

Connections through a bi-directional flow into the station under the highway

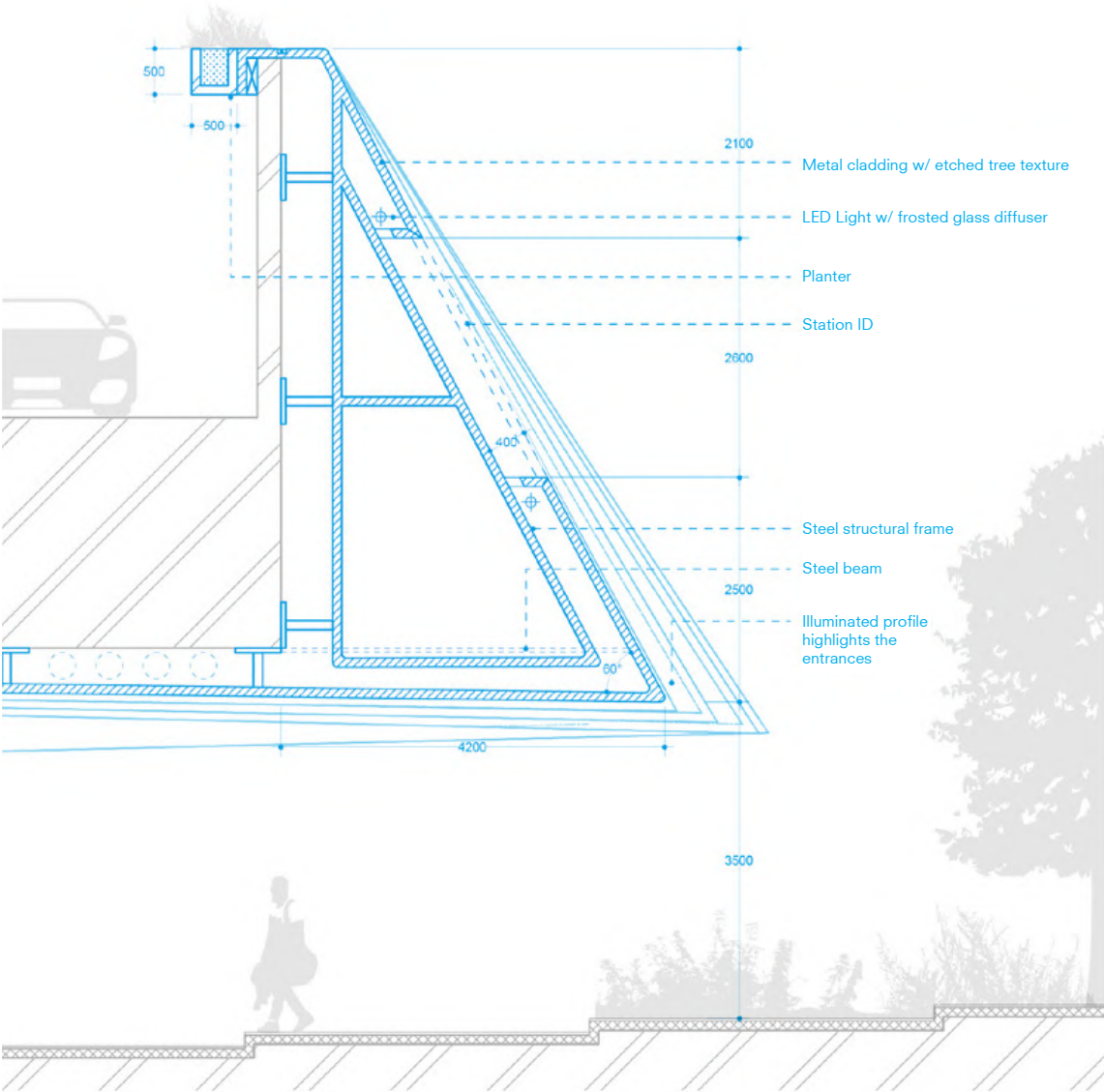

Entrance Canopy Detail
Building Technology Section
1 : 20

Furniture & The Underpass

Spatial Qualities & Materialisation

The underpasses under the A16 highway are the only connection points between the two areas the Metro Station will be serving. The underpass at Prinsenlaan was selected as the location for Metro Station Bos as it is located in the middle of these two areas. Currently the underpass is only used as a traffic corridor, and is an unpleasant area to pass, let alone spend time. By placing the station here, the aim is to both improve the connection between the two areas as well as improving the character of the underpass, while making use of the positive qualities it offers.

In order to make space for the Metro Station entrances, new program and (improving the) infrastructure, the surface of the current underpass will be enlarged. These newly created parts of the underpass are designed as a pedestrian and recreational space, of which the entrances to the station will be part. This all forms the starting point for the design of the public space.

Public Space

The design for the public space builds heavily upon the elements that are given for the location. This means the program is tested and inspired by the qualities of lighting, shelter, size and materialisation of the underpass. The program of the public space is designed with the idea of improving the connection node by binding people to the space, instead of only passing by; making the space and the Metro Station in it, part of people's everyday life.

In the design of the public space, the program can be organized in five categories:

- Recreational facilities
- Sporting facilities
- Entrances Metro
- Facilities serving (Metro) users
- Traffic

Because of the specific characteristics of the underpass, not all examples that fit in these categories are suitable for this location. With the help of analysis and research on reference projects, the different components of the infill of the underpass were selected, aiming at involving different target groups (activities, ages, reasons for being there etc.).

Furnishing or Designing?

Facilities mentioned in the five categories above, are mostly quite fixed designs or at least come with specific boundaries. The question arises whether the infill of the public space is really a matter of designing or merely 'furnishing' the space. Because the idea of a 'living' program under the underpass is such a key element in the design concept and the location of the Station, the reasoning behind the layout of this space cannot be left untouched.

The 'architectural' part of this design is therefore in a way limited to the structural elements and their placing, the location of the entrances and surrounding elements, along with the materialisation of the surfaces.

Each of these design choices have to fit within the boundaries of the facilities and program, which could be seen as 'furniture in a room'. The design of the underpass might therefore not be as interesting in a strictly architectural sense, but it is however, an interesting lesson in sizing and coping with fixed conditions of products. The way these objects are using the qualities of the 'architectural' parts of the design herein, is the main hand-grip in their placing, and the key behind motivating the design choices.

1. Underpass Park, Toronto

Public recreational activities have turned out to be successful examples of program for the infill of public spaces for underpasses and viaducts.



4. Three Squares, Olina

Concrete benches along the slopes leading down to the underpass make for a smoother transition. The Three Squares project in Olina is a good example of the atmosphere we envisioned.

2. Underpass Park, Toronto

The transition from the public space around to the open public space under the underpass has to be a welcoming path to the station entrances.



5. Pop Up Cinema Folly for a Flyover by Assemble, London

Larger public activities such as outdoor cinema, markets, open amphitheatre are a perfect fit in combination with the existing qualities of the underpass. They would ensure more binding of citizens with the place.

3. Vijzelgracht, Amsterdam

The deep descend to the station platform at minus 24 was loosely inspired by the Vijzelgracht Station.



6. Public Newspapers

In many non Western (and some Western cities) the concept of free public newspapers at stations are common. Research has shown that people take this service in mind when planning their day, hereby making the station more part of the daily routine.

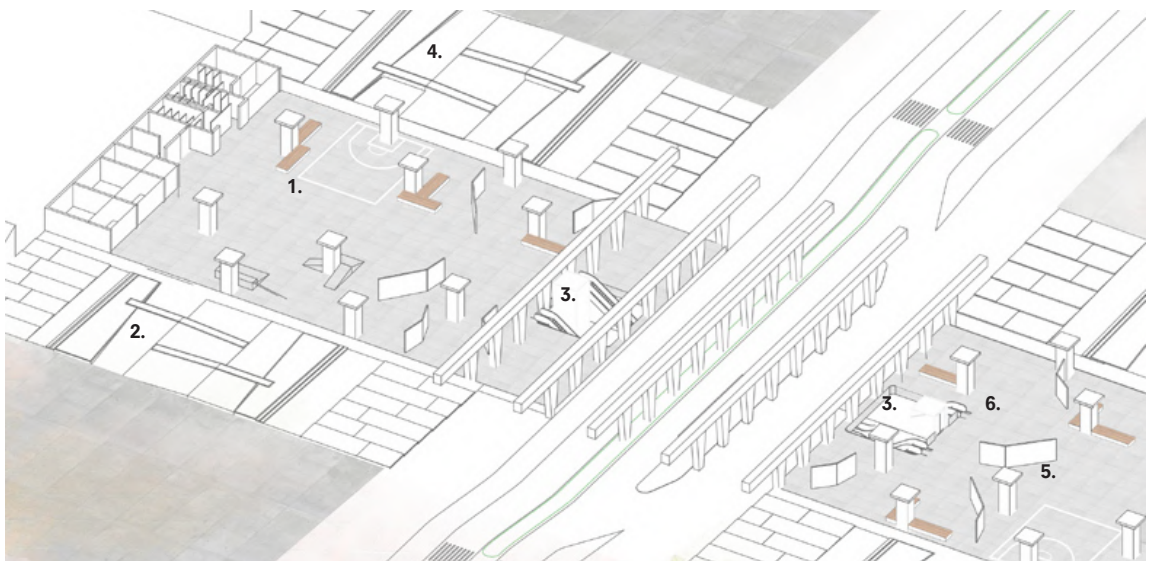

Light & Nature

The concept is based on contrast and contradiction. The contradiction is between the two parts of the metro station: above ground and below ground.

Above ground what we see is concrete and darkness. In other words the lack of nature and lack of light. To emphasize this situation, the underground part of the station is the complete opposite: full of natural light and nature.

By bringing the nature underground we see a contradiction: usually we don't find plants growing below the ground level. The same we can say for light: we expect it to be dark, where the sun can't shine.

The light is emitted by both LEDs, and glass fibre light conductors. The latter collects light from above the highway, and transfers it to the metro station.

To compensate for the changes in lighting conditions, there are sensors above the platform, which sense the dimming of light, and send a signal to the LEDs to increase their brightness.

The light sources are placed behind a diffusive layer, a translucent polypropylene sheet, that disperses the rays.

In front of the diffusion layer, there are vertical steel wires every 60 cm, so that climbing plants climb on them, creating a more natural environment inside the metro station, and evoking the feeling of the Kralingse Bos.

The wall of light and nature is within arm's reach on level -1, but on the platform level, the train tracks are between the passengers and the wall.

The brightness of the wall decreases from bottom to top, strengthening the feeling of being upside down, because in the nature it would be the other way around. The brightness being dimmer on level -1 is beneficial for the exhibition, only diffused, dim light reaches the artworks.

The structure is mounted on the concrete wall of the station. The light sources being spread apart, a 15 cm cavity is needed for the diffusion layer to properly work. The diffusion layer is held by a steel structure, consisting of L profile beams holding the diffusion layer, and L profile consoles anchoring the structure to the wall. The consoles are anchored to the wall with pre-cast Halfen rails, nuts and bolts.

The steel wire is in front of the diffusion layer, and there is a 20 cm gap between them for the plants to have enough room to spread.

As for the choice of materials, I tried to balance out the 7 high-tech, modern glass and metal, and cold, unfriendly concrete with the warm and familiar nature, and with the presence of natural light.

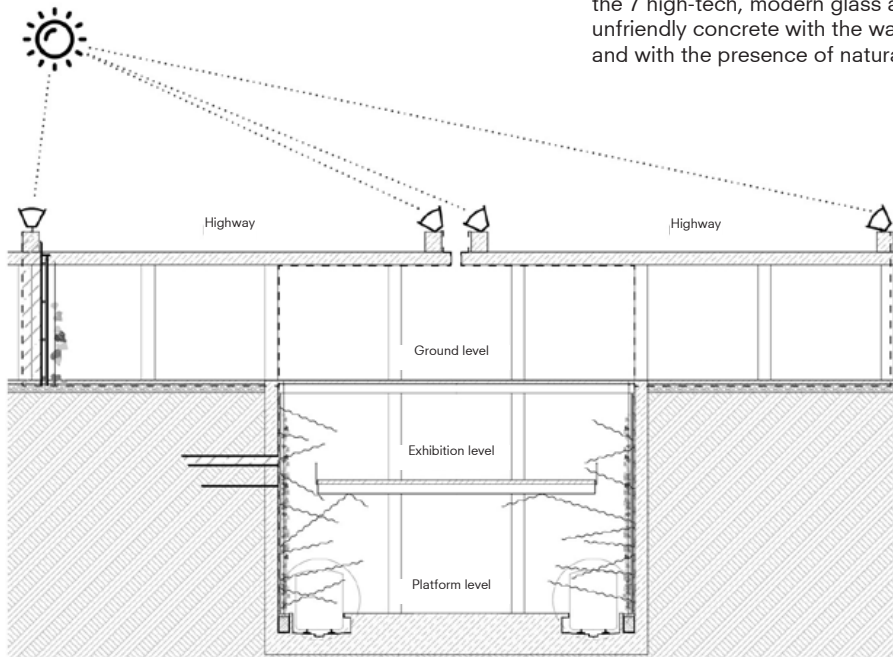

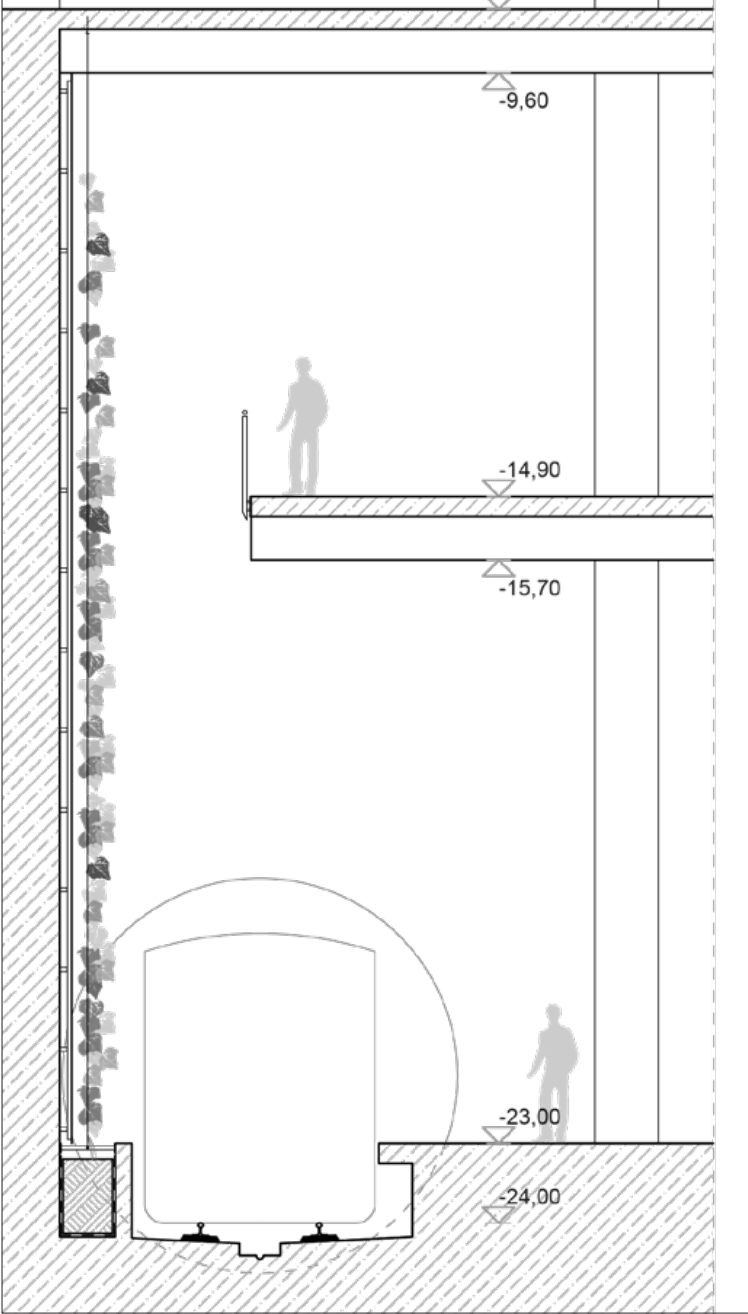





KRALINGSE ZOOM

Collective Research Location & Characteristics	113
Conceptual Scenarios Visions	129
Go Green! Killing the Car	131
Go Under! Kralingseberg 2030	151

Nigel Flanagan
Anna Shishkina
Bethany Kiss
Jasmin Goldberg
Romy Weeteling
Lorenzo Bondavalli

The station and its context

Kralingse Zoom

Kralingse Zoom Station is an integral fragment of future projections for Rotterdam city. The need to view Stations as more than just mobility points connecting the city and beyond it is an important pressure on cities set to intensify. This pressure comes from population increases and the increased value of space. Kralingse zoom is a car centric and commuter orientation station that enables this use by allocating space for 'Park and Ride'. The temporal nature of the station with fast food outlets with only standing spaces and very limited seating makes for a space that is for the commuter only requiring to get from A to B – this is due to the current design of the station not allowing people to hover any longer than is needed to grab a quick bite to eat. With plans for 50,000 more homes in the area this is a move towards densifying the station which calls for a focus on the increased amount of pedestrian activity that will be seen around the station.

The station, with the proposed circle line is a very well connected place that will become a key catalyst in the future of Rotterdam as a growing city. The fragmented nature of the community surrounding the station is important to consider - The station has an opportunity to be an anchor and meeting point of connection.



Site context map (pedestrian radius)

Hard Data History & Land Use



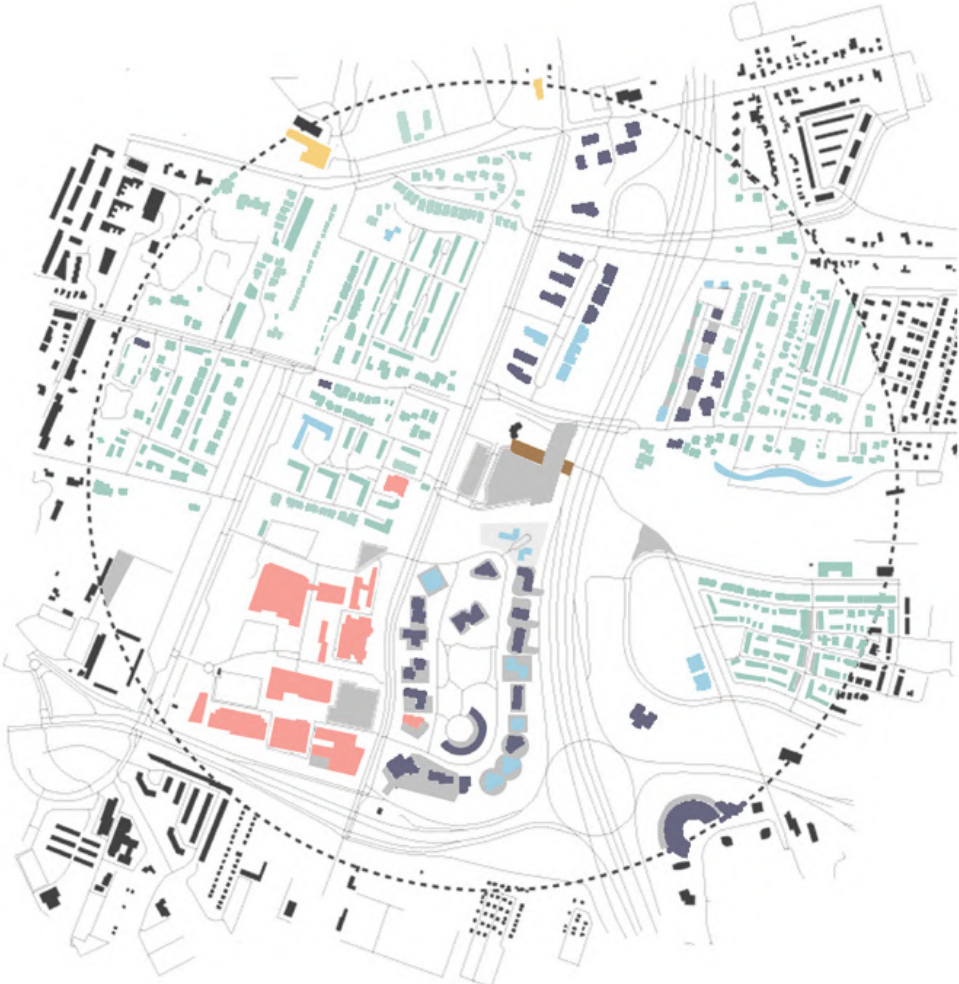

On the Platform

The platform is an area with a high frequency of movement with unpleasant places to gather and wait for trains. This is both due to the high wind and limited places to sit, the movement of people and the movement of trains. People observed don't spend much time waiting around on the platforms. They move from the trains to certain destinations making the platform itself not a destination.

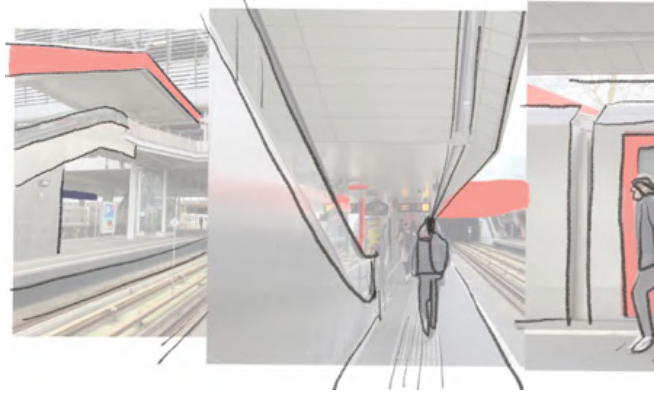

Outside Car park

The outside car park is used as a space for over spilling cars from the enclosed car park. Most notably the car park is used as a thoroughfare for people (mostly students) as a short cut to the University campus or surrounding neighbourhood area. This is used as a thoroughfare during the weekday when many people are cutting through to make it to the other side. We noticed that there is in fact a pathway already existing for people to use however, this route would take longer than the short cut.

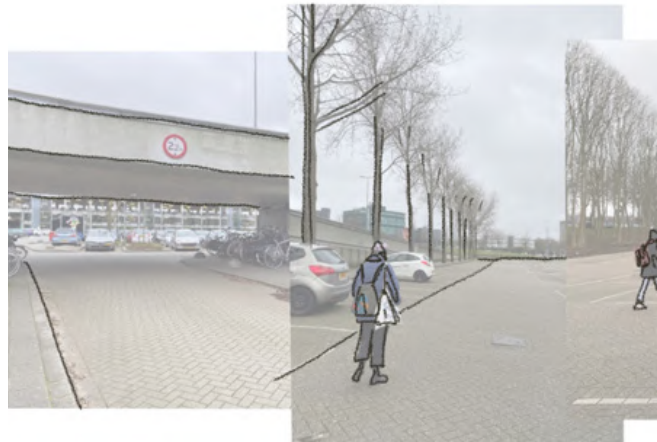

Waiting for the Train

Due to the platform being an unpleasant area to wait, the majority of people gather in the entry area. The entry area has a small supermarket, hot foot stalls, limited places to sit and places to buy tickets and ask questions at the information desk. Due to these limited seating options we can see the people gathering around are standing on tables.



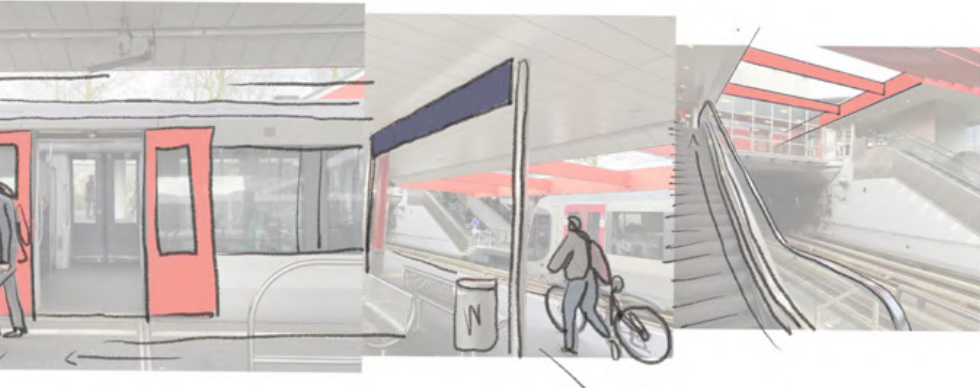

Site Accessibility - Public Transit

Bus, tram, train, & shuttle

From the transit map it is clear that Kranglise Zoom exists as a transport hub for the area, with Metro lines, regional and metro bus lines, tramlines and a park shuttle all existing within the area. Connections to greater areas of Rotterdam exist both in the north-south and east-west directions, and thus a challenge exists in integrating these existing routes with the proposed new line.

Site Accessibility - Roads & Paths

Cars, bikes & feet

Being a car-centric commuter station, it is clear from the site accessibility maps that the roads dominate, with significant road networks leading into the station while the bike and foot paths are relatively spare. Situated next to the A16 highway the station is accessible by a large part of Rotterdam who then use the car parking facilities and use the station to access the centre. This is led from the huge road network that the station site is connected to through the A16 highway.

Due to this car-centric nature, the surroundings of the station are not to the human scale, creating rather unpleasant, windy spaces in which no one was observed to gather.

It was interesting to see that people did not tend to use the provided pedestrian and cycling infrastructure with surprisingly few cyclists spotted on each visit. Furthermore, pedestrians did not use the footpaths to access the station, but rather tended to cut through the open air car park to the south of the station as a short cut to get from the university to the station.

The concentration of footpaths within the area are contained within the residential areas or the office and brain parks. The footpaths that do lead to the station are all adjacent to large roads, making the experience unpleasant and not making the area comfortably walk able. Furthermore, there are few walking paths with traffic lights, meaning that either pedestrians or motorists are required to wait for each other to enable access to the station.



Public transport accessibility to site

Kralingse Zoom

Opinions of the station by its users

The users of Kralingse Zoom are very used to the station as it is. It doesn't stand out and it doesn't interfere. Within the success of Kralingse Zoom the car is an essential element. The station is well connected with the city centre of Rotterdam. Together with the enormous Park & Ride parking lot and garage the car-users are offered a safe spot to park their automobile. As the station is situated next to the highway A16, the station is easily accessible. The main users of the station consist of residents of the area, students of the nearby universities, office employees of the office parks and the general public transport user who want to get to the city centre.

The sober Dutch mentality of the users is guiding the interviews. At the start of every interview the people are not really that bothered by the way the station works but after I try to dig a little deeper into their experiences, small concerns about the project are raised - mostly solving personal problems. Nevertheless, the users showed me the general important core interests:

- The station is very **car-oriented**. It's used to get to the offices and universities in the area but also to get to the **city centre**;
- The **highway** next to the project makes it very easy accessible by car;
- Although there are a lot of people, the station is **not lively**;
- The station is equipped with a very futuristic **autonomous shuttle**. Remarkably, nobody knows about it or notices it. "Normal travellers" are also not able to use this service but it is only available to employees of companies;
- The direct area of the station is used a lot by **pedestrians** however there is not a path to use. The pedestrians are criss-crossing the parking lots to get to the universities;
- The entrance hall is **not inviting** but a space to pass through;
- after working hours the station is **abandoned**.

Current Situation

Car-oriented



Connection to city centre



Next to highway



Not lively



Autonomous shuttle



No pedestrian paths



Not inviting - abandoned



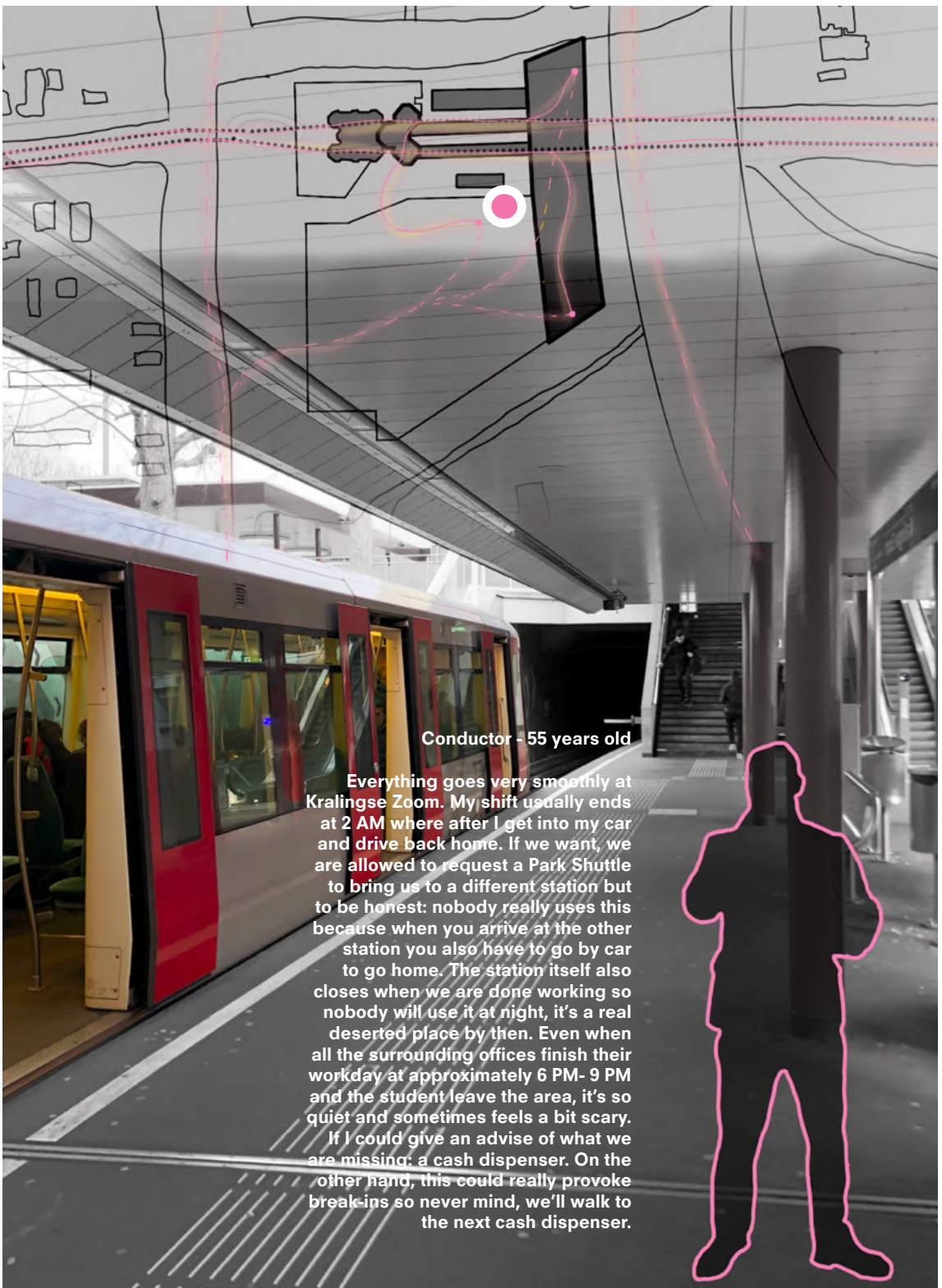

Conductor - 55 years old

Everything goes very smoothly at Kralingse Zoom. My shift usually ends at 2 AM where after I get into my car and drive back home. If we want, we are allowed to request a Park Shuttle to bring us to a different station but to be honest: nobody really uses this because when you arrive at the other station you also have to go by car to go home. The station itself also closes when we are done working so nobody will use it at night, it's a real deserted place by then. Even when all the surrounding offices finish their workday at approximately 6 PM- 9 PM and the student leave the area, it's so quiet and sometimes feels a bit scary. If I could give an advise of what we are missing: a cash dispenser. On the other hand, this could really provoke break-ins so never mind, we'll walk to the next cash dispenser.

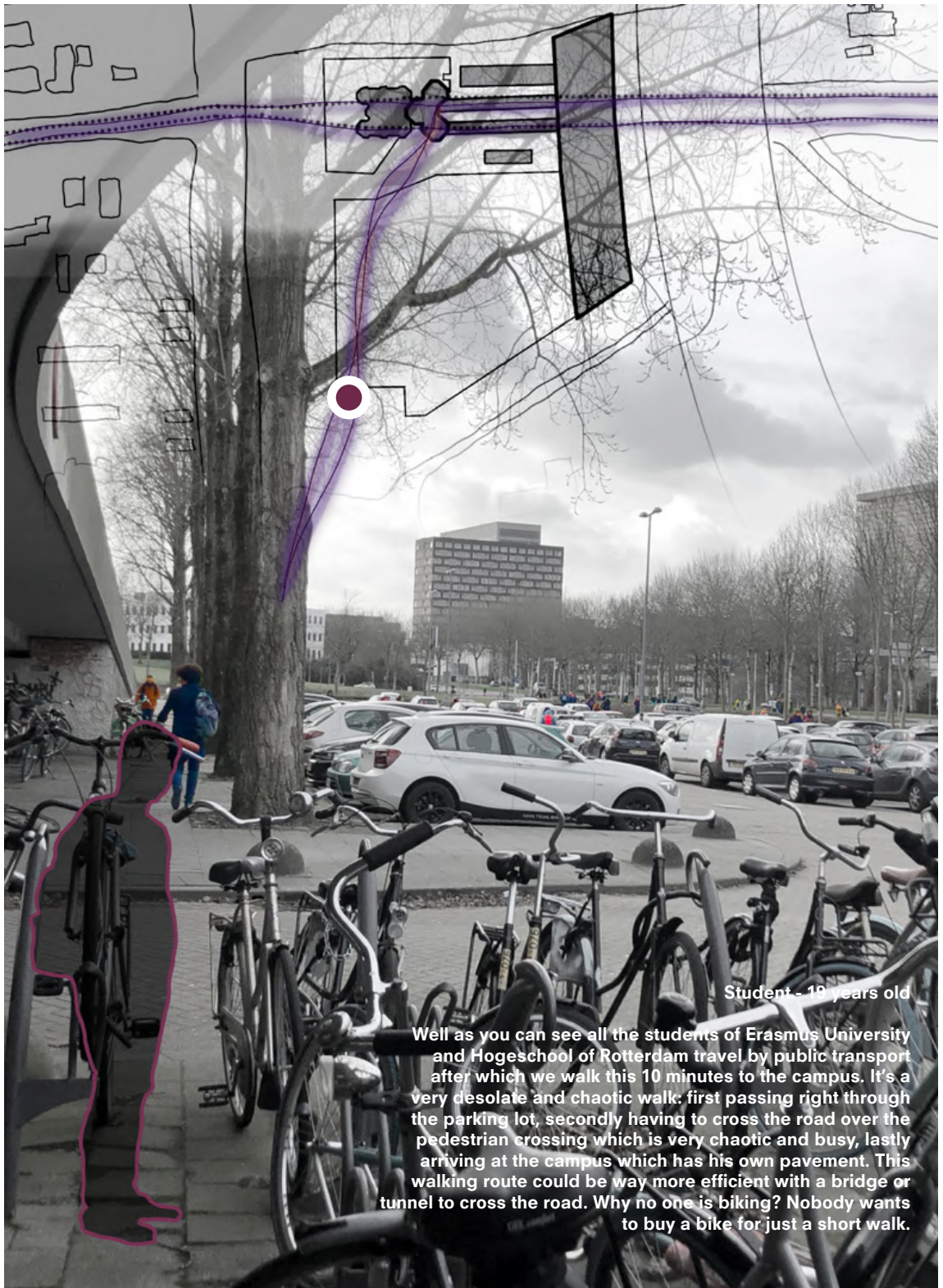

Student - 19 years old

Well as you can see all the students of Erasmus University and Hogeschool of Rotterdam travel by public transport after which we walk this 10 minutes to the campus. It's a very desolate and chaotic walk: first passing right through the parking lot, secondly having to cross the road over the pedestrian crossing which is very chaotic and busy, lastly arriving at the campus which has his own pavement. This walking route could be way more efficient with a bridge or tunnel to cross the road. Why no one is biking? Nobody wants to buy a bike for just a short walk.



Park Shuttle Kralingse Zoom
12-02-2020

*Treinreiziger.nl. (2019, 18 september). Nieuwe zelfrijdende Parkshuttle vertraagd .

Existing Station

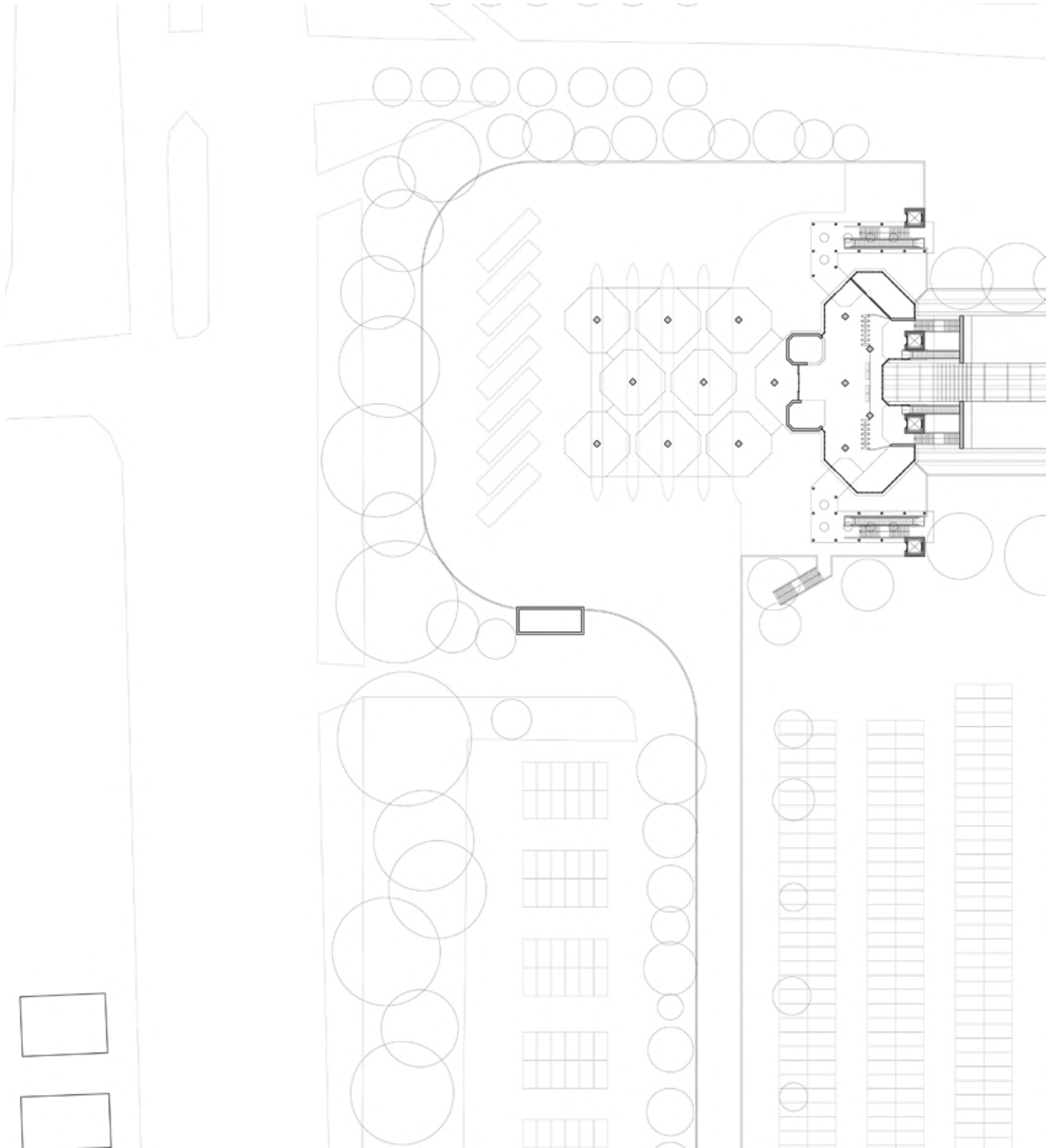

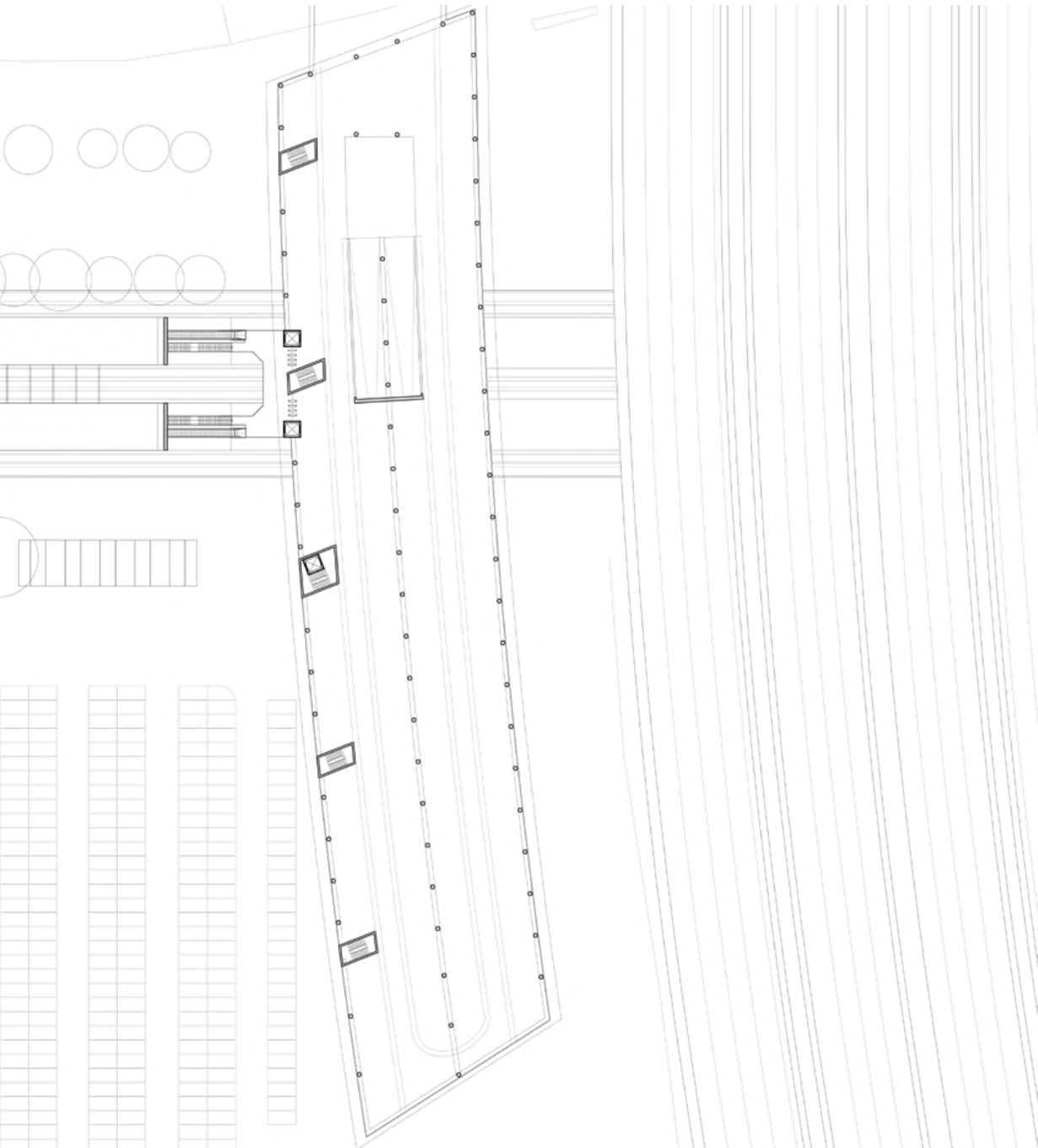

Existing Station

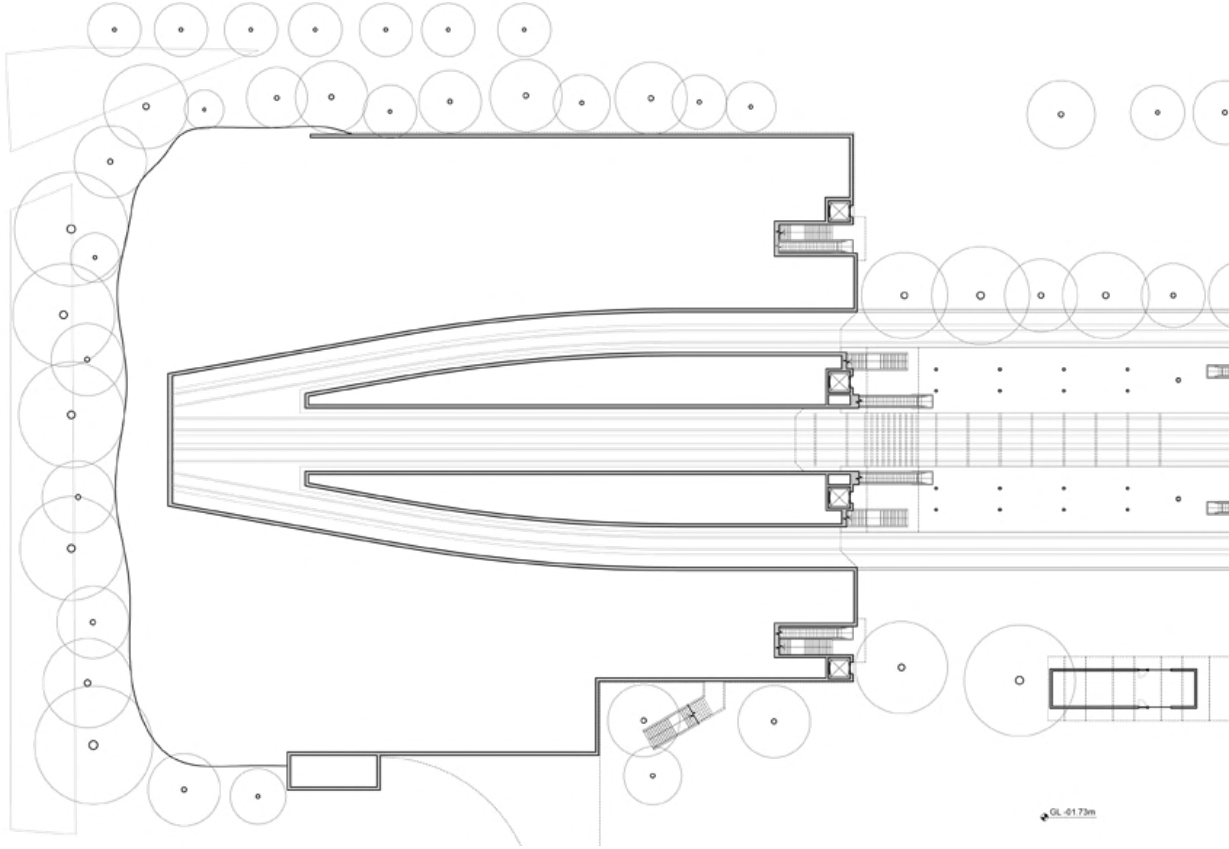

Plan 01

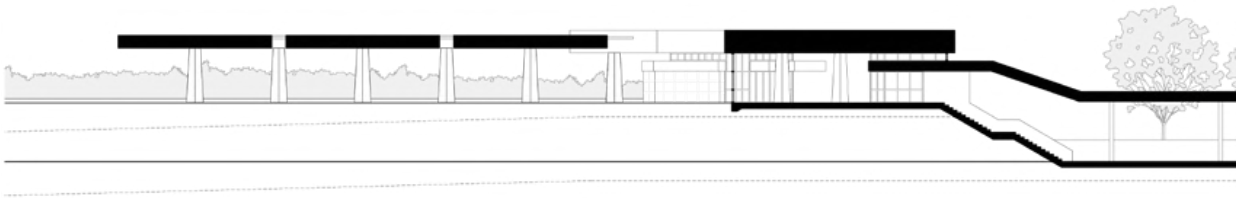

Section A-A'

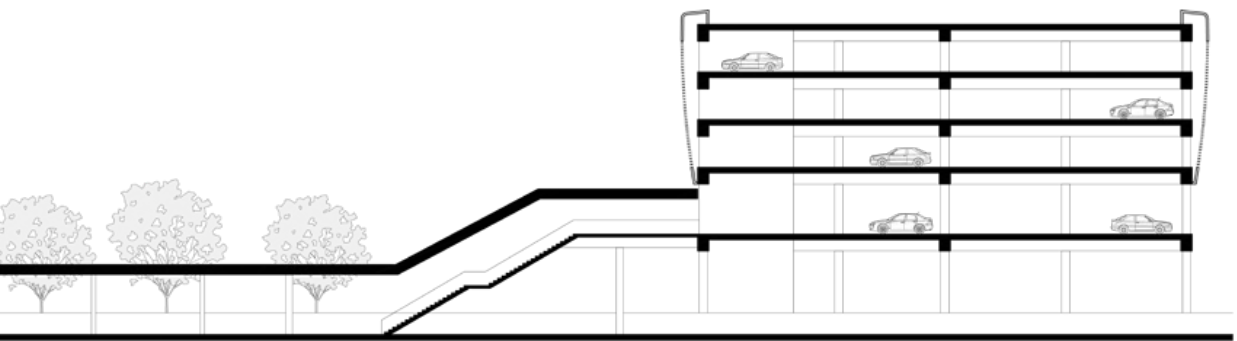
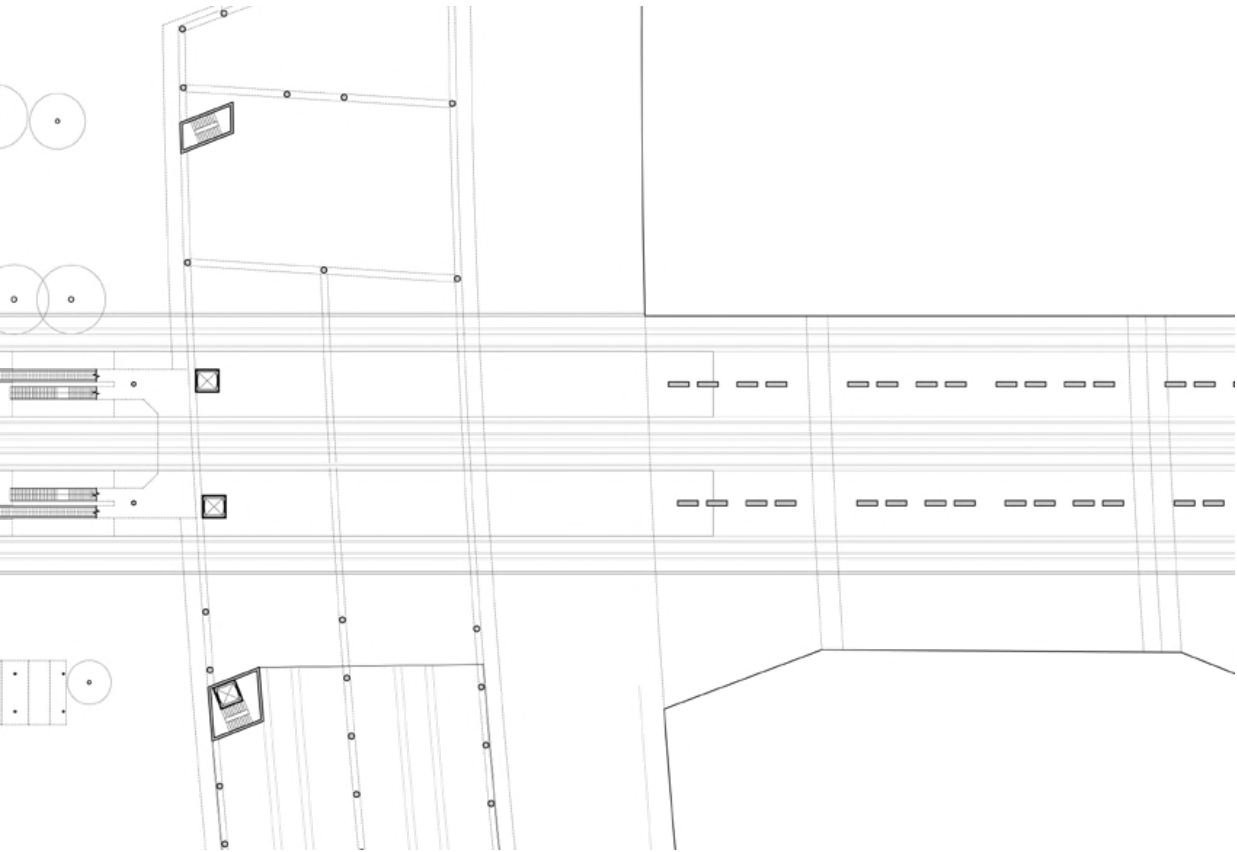

Vision 1

Go Green!

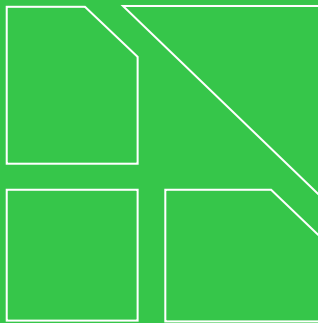

Fragmentalisation - Human centric design

Connectivity - modes of transportation

Hybridity - Visibility - Landscape

Nigel Flanagan
Anna Shishkina
Bethany Kiss

Vision 2

Go Under!

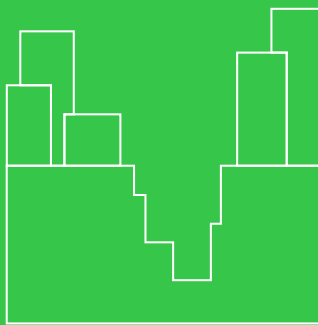

Design by research - Speculativity

Incremental Design - Grid - Society

Programmatic Diversity - Verticality

Lorenzo Bondavalli
Jasmin Goldberg
Romy Weeteling



Killing the Car

Kralingse Bos Station
Go Green!

Nigel Flanagan
Anna Shishkina
Bethany Kiss

Narrative

Kralingse Zoom is an essential component of the proposed Metro line and a key catalyst in the future of Rotterdam as a growing city. Situated just one stop away from Rotterdam Airport, the station is efficiently positioned as a future gateway. At present, there is an existing RET line and bus station at Kralingse that provides connection points to the 'Brain park', Erasmus University, residential housing and extensive car parking areas. The station therefore currently lends itself to enable users of the station to purely 'Park and Ride' and as a result, the station is dominated by cars that are overshadowing pedestrians.

A central consideration of our design is to flip this perspective around, make the pedestrian experience the priority. Firstly, we considered how the existing user interacts with Kralingse Zoom in order to produce a future transport hub that is well situated and thoughtfully considered in the existing urban fabric. Kralingse Zoom acts an anchor point for the neighbourhood that connects the conflicting fragments of social classes that surround the area. Residents, consist of two distinctive demographics; one side being affluent and the other being of a lower socioeconomic. The students from Erasmus University interact with the station sporadically throughout the day, overwhelming using the station on weekdays, leaving the area barren at night and on weekends. The office workers operate in a similar fashion however, these workers use the station not so typically for the transport connections but for the food outlets. Majority of these office workers make use of the 'Park and Ride' facilities that are provided. Overwhelming the station is not being utilised at night and on weekends. We asked ourselves, how can we create a space that thoughtfully involves all of these users? Our design therefore intends to strongly consider the unique perspective of dealing with an existing station and an area that is already so highly developed.

Together with this strong and thoughtful analysis our design lends itself to a conscious effort in considering the current users of the station as well as future. Three fundamental principles have shaped our project: Connectivity, Density and Human Centric Values.

Connectivity

Kralingse Zoom as mentioned previously is a key component of the new circle line – we predict that Rotterdam will become a tourist hub of activity with an increased pressure on the city to perform and meet the needs of a growing and changing society. The new Kralingse Zoom line will need more than just a new station with a metro link, the urban design around the station creates a thoughtful response to the existing urban fabric.

Ensuring that each person who uses the space feels comfortable and safe at all times of the day. We therefore have studied and categorised these users into two key categories:

User A and User B. User A interchanges between both metro lines at Kralingse Zoom and requires an efficient connection. User B interacts with the station as a local connection to the neighbourhood and thus, interacts with the surrounding. The location of the station on the wider network means User B can commute from a wide range of areas on the city as well as living in the local vicinity of the station. Our stance on user experience as a central aspect of our design has explored the shift in the nature of the station away from car centric 'park and ride' values. Therefore, we have envisioned a reboot of the urban fabric shaping a shift to more thoughtful and carefully considered urban space that puts pedestrians first. The connectivity of the station with the new Metro line, existing RET line and bus connections means the need for car parking naturally is enabled to be faded out. There are already plans in motion now for the 'Park and Ride' facilities to be completely removed from the surrounding 'Brain Park' areas.

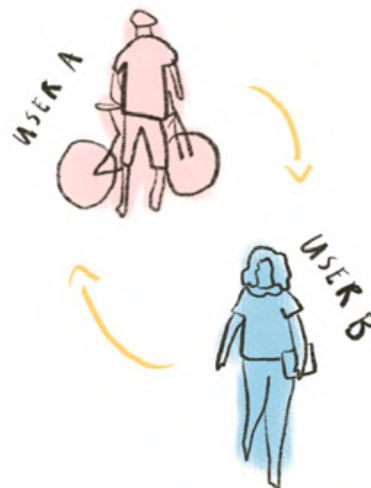

Density

The natural densification of Kralingse Zoom has been planned with buildings that are strategically placed to meet the needs of the community's growing population and to create an inclusive community space that will enhance the vibrancy of the area. Particularly, the vibrancy at night time and during weekends has been a strong consideration. Public functions such as, community library, local gallery spaces, basketball courts, community centre, shops and cafés. As well as this, providing housing to meet the demands of future growth. These functions carefully ensure there is constantly people who will be using the site at all times of the day.

Human Centric values

The design of Kralingse Zoom from the beginning has centralised around the experience of the user as the most important priority. With this in mind, the station has been designed to be an open aired station, creating visual links between the metro line and the surrounding areas. The pedestrian is at no point in the design left feeling dwarfed by deep underground connections instead, the pedestrian is at all times connected to the natural world around.

The new design of the urban spaces along with the proposed station, will thoughtful echo the existing urban fabric of Kralingse Zoom creating a place that is welcome for every user, with the backbone of creating a transport hub whereby the existing line and the metro line inform efficient transport connections. These two elements together make a well-considered place that will help positively shape the identity of Kralingse Zoom and become a destination for not only the existing users but for the entirety of Rotterdam and beyond.



Killing the Car

A catalyst for a human centric urban fabric

The removal of the car re-envision the isolated suburban neighbourhood where car parks dominate the landscape. Car parks become an opportunity to densify the area with residential use and amenities that can create a dense urban setting. Roads become streets. New residents bring a sense of community and life to currently office dominated enclaves that lie empty in evenings and weekends.



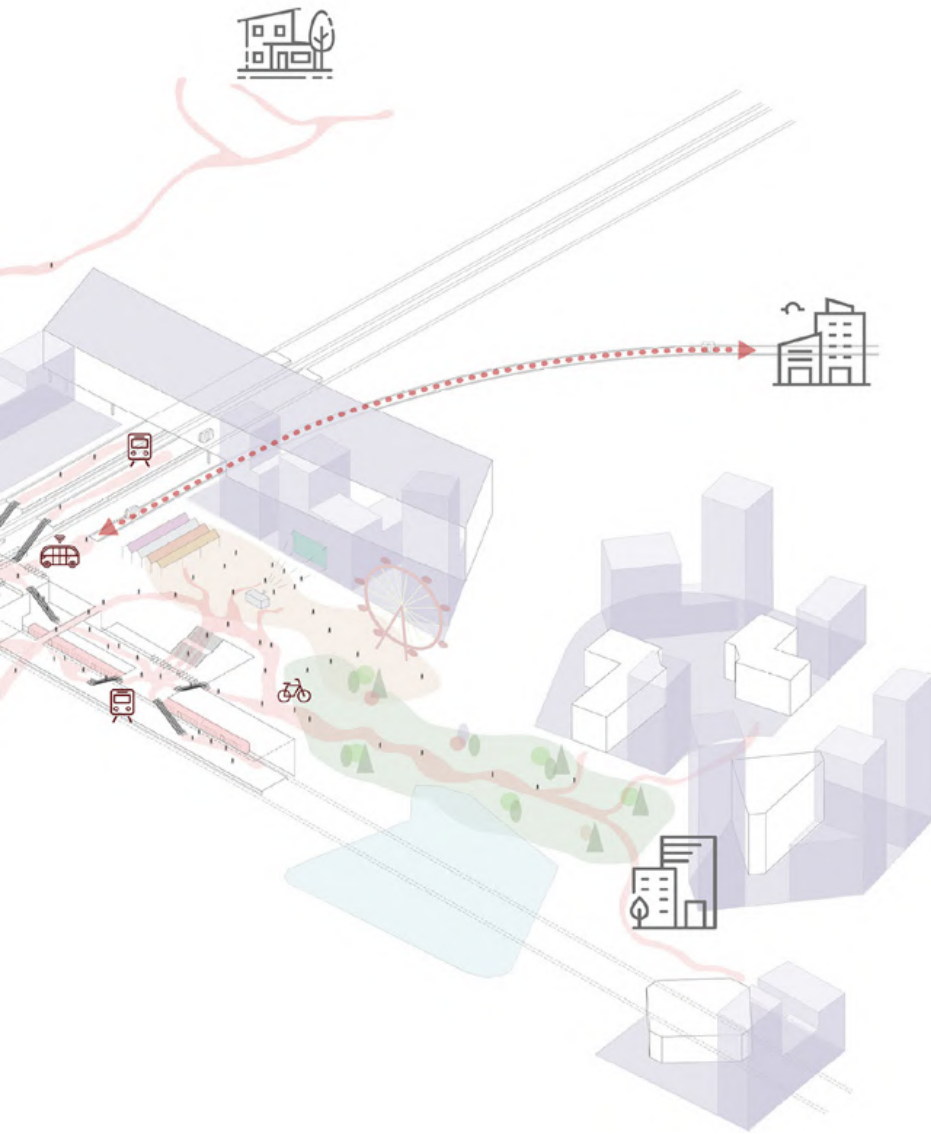

Killing the Car Concept Summary

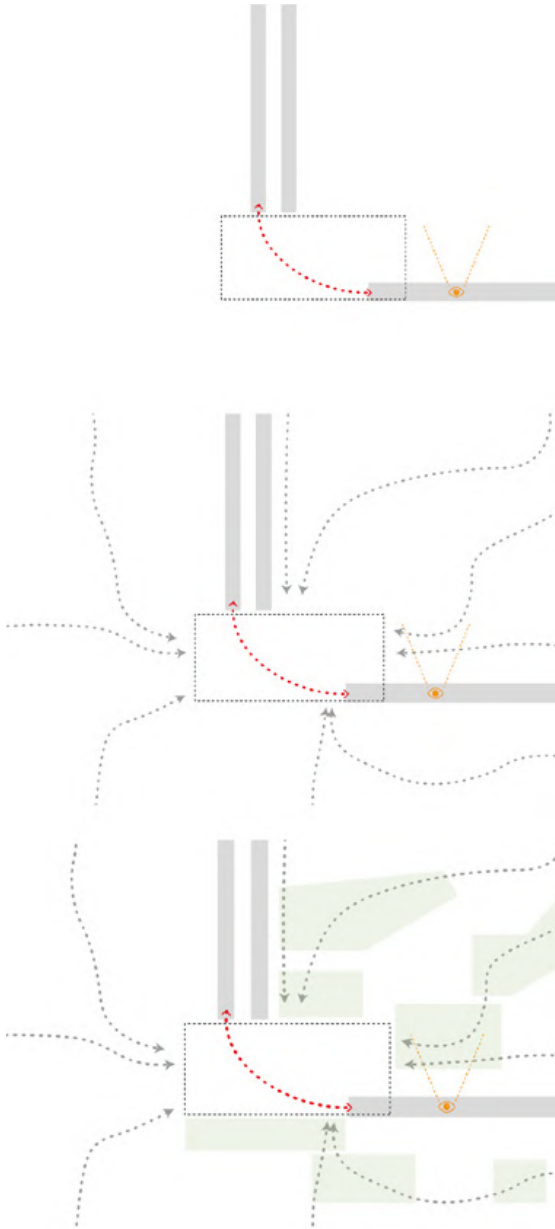

Visual Connection

Visual connection to the local context creates an immediate sense of place.

Local mobility

Local connections and site permeability integrates the metro with the surrounding neighbourhoods and allow for commuters and locals to use the metro.

Urban Landscape

Human scale terraced squares create natural opportunities for social interactions as people walk between the metro and the surrounding university, offices and residential.

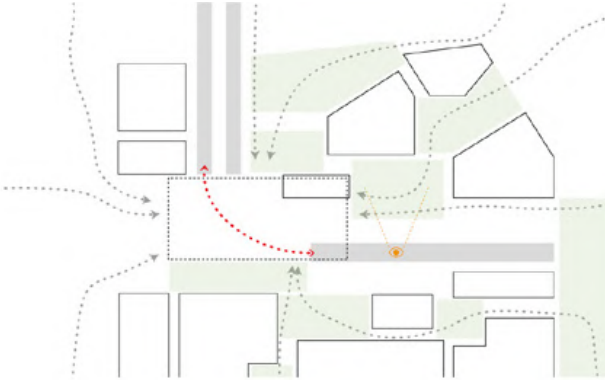

Dense Urban Fabric

A dense urban fabric provides social function opportunities and climatic shelter for the squares, allowing for enjoyable usable public spaces.

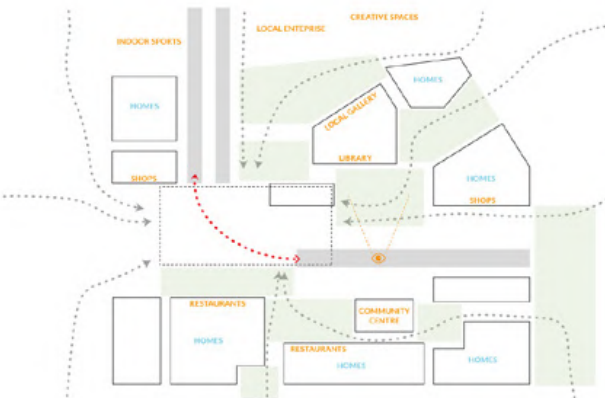

Public Functions

Residential densification can provide a constant population on the site whilst mixed use community functions such as libraries and youth centres create a sense of place and belonging for the local people who will use the site.

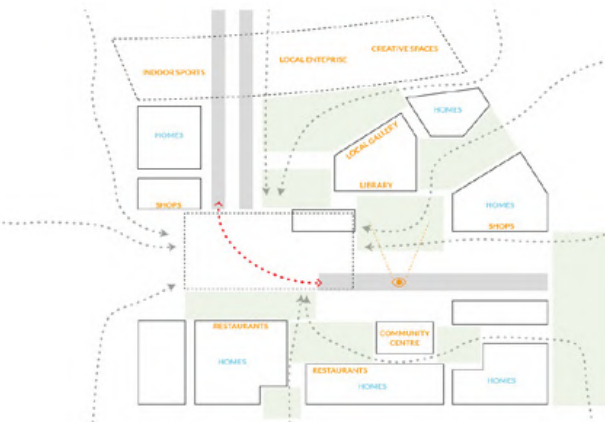

Multistory Car park Re-use

With the removal of cars, the multi-storey car park provides an existing structure that can be re-purposed into affordable low rent enterprise and creative spaces for the local community. The reuse of the car park for local affordable use aids social inclusion

Drawings

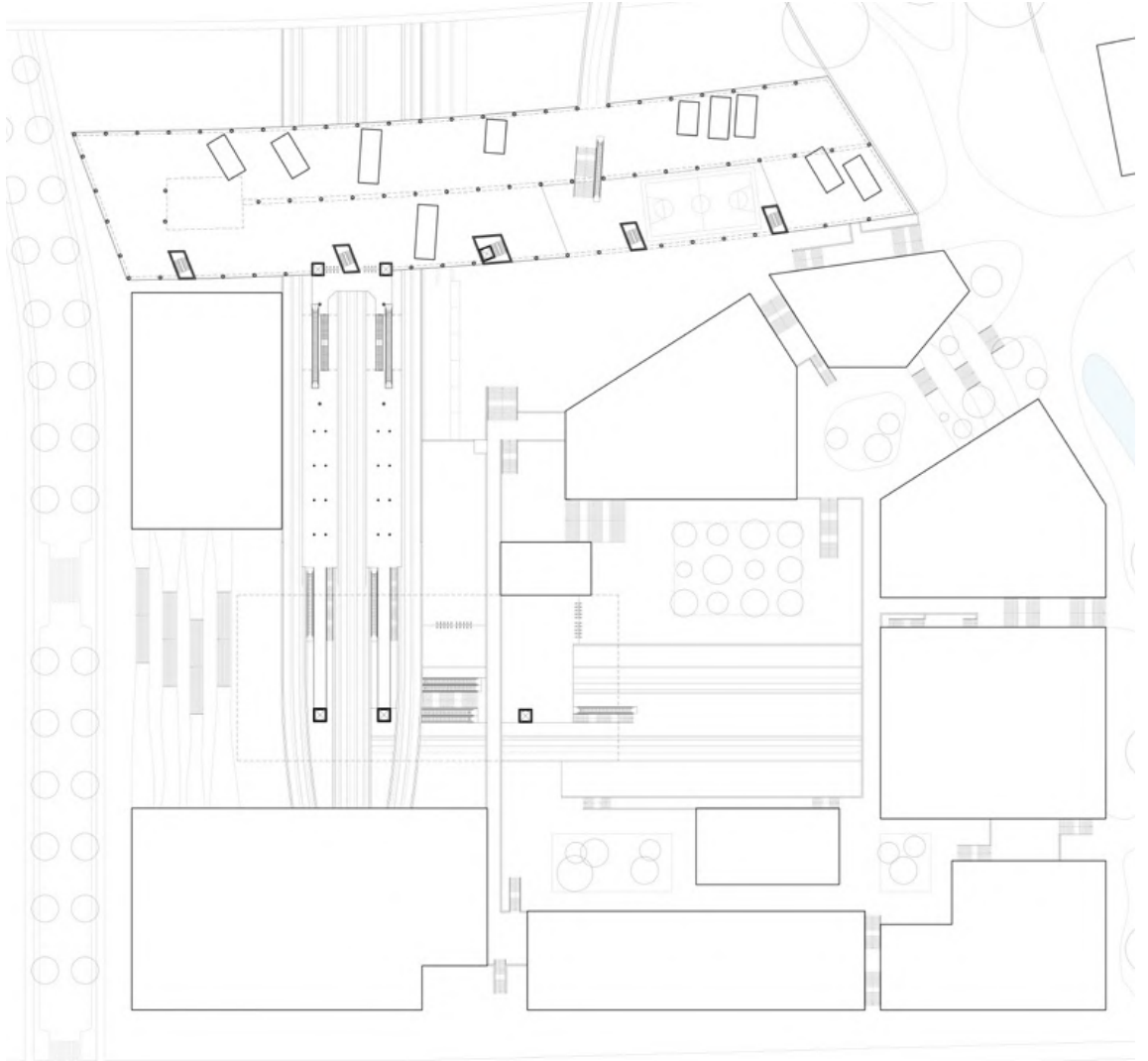

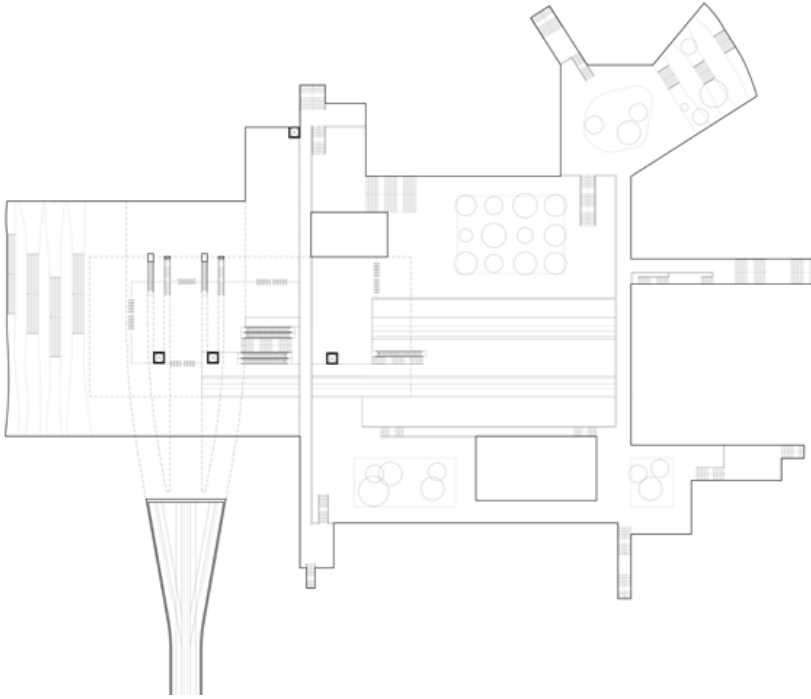

Floor Plan
Level 0



Floor Plan
Level 2

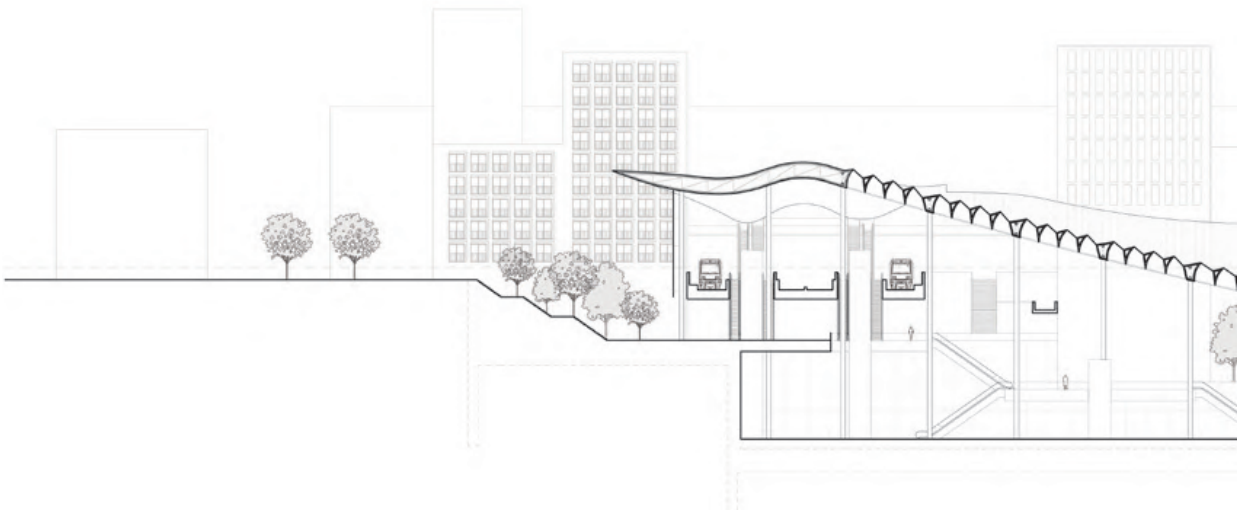

Long Section

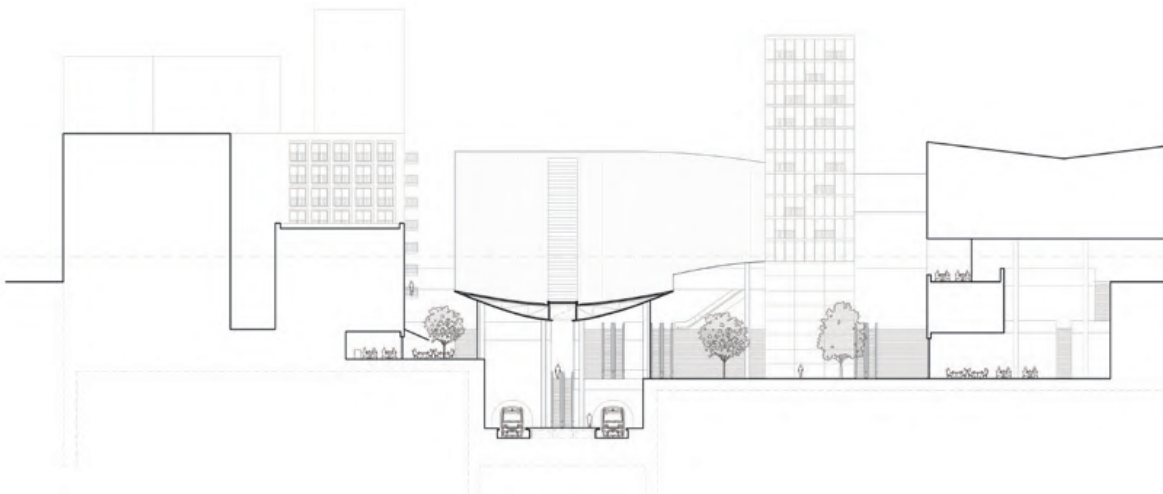

Short Section

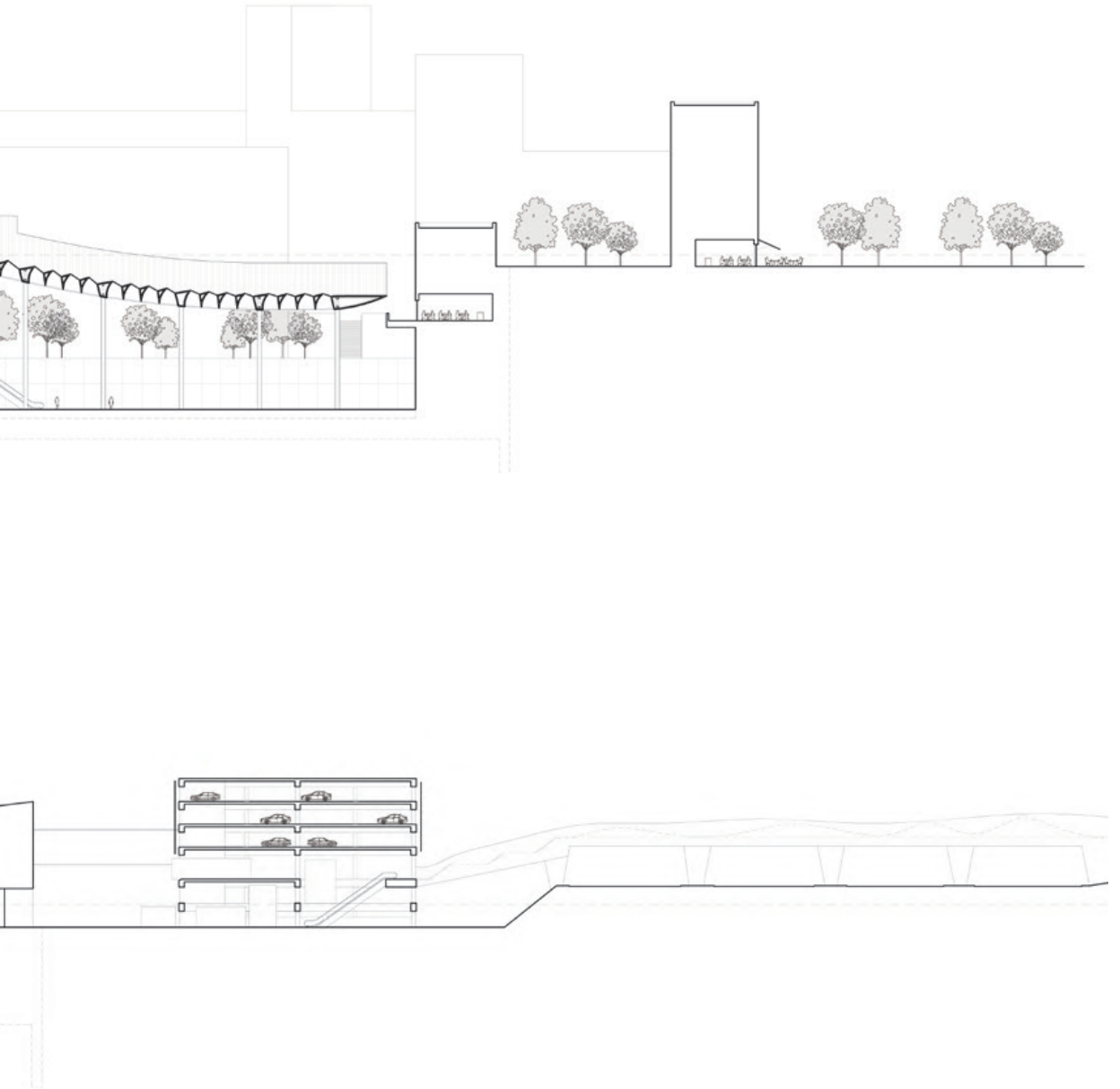

Introduction

Roof and the language of connections

By taking on of our guiding principles, connections, the design for the station roof can become a useful tool for navigation, way-finding and connectivity. We can emphasise the guidelines of User A and User B (see pg. 134) and the idea of connectivity both as an internal transfer and as a visual connection to the surrounding.

As we explore the form of the roof, we first encounter diffuse light as an architectural element that can be manipulated to create a sense of connection between metro lines. The central well of light can create a visual path along the escalators and emphasise the internal transfer.

When we proposed an open metro station, the important idea was that of the visual connection. To celebrate where the infrastructure of the metro station can meet the urban world enabled around it. Using reflections creates an opportunity to emphasise a sense of place and reveal views to the outside. Travellers, upon disembarking the train will be able to see through on the reflective roof, views to the squares and city world above them.

The form of the roof is derived from the development of light and reflection as design tools. The roof swoops from the low levels of the circular line and arches over the existing lines. This creates a clear view path at which the diffuse light wells can illuminate the space and carry the eye from one platform to the other. As this happens, the roof slopes upwards on its sides. This creates a sloped angle at which the lines of sight from the platform can meet the public squares and the city through the reflections of the roof.

Diffusing Light

The roof's first design intention is to use diffuse light as an architectural tool. The diffuse light can be a way-finding aid. The light draws the eye down the platform and stairs. The station is lit by this central skylight that, due to being linear in nature, provides an orientating effect of sorts.

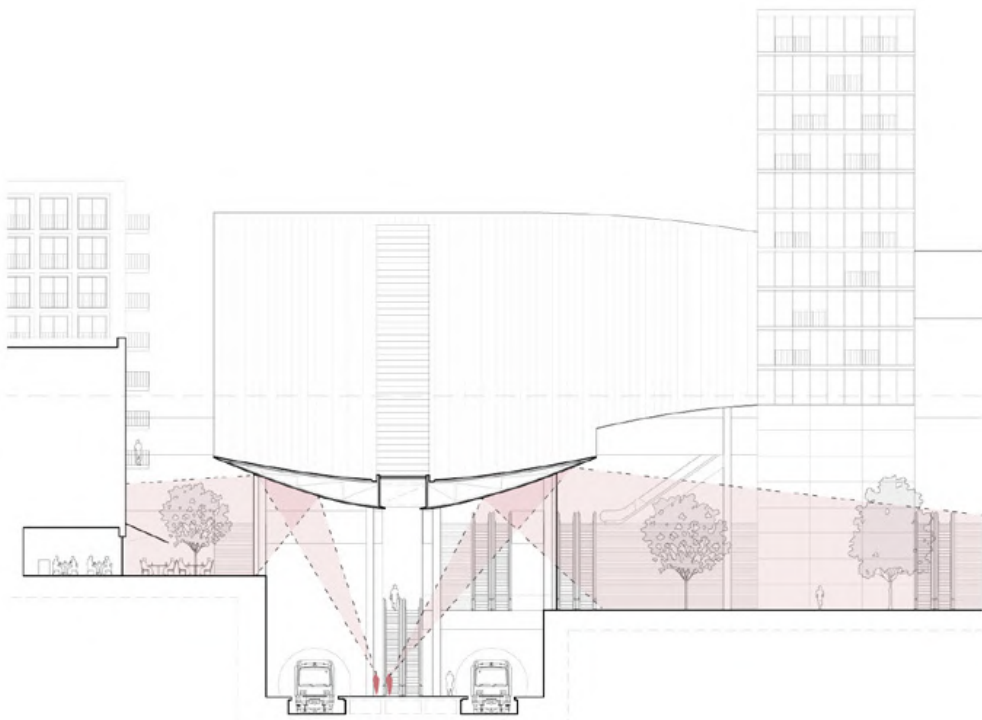
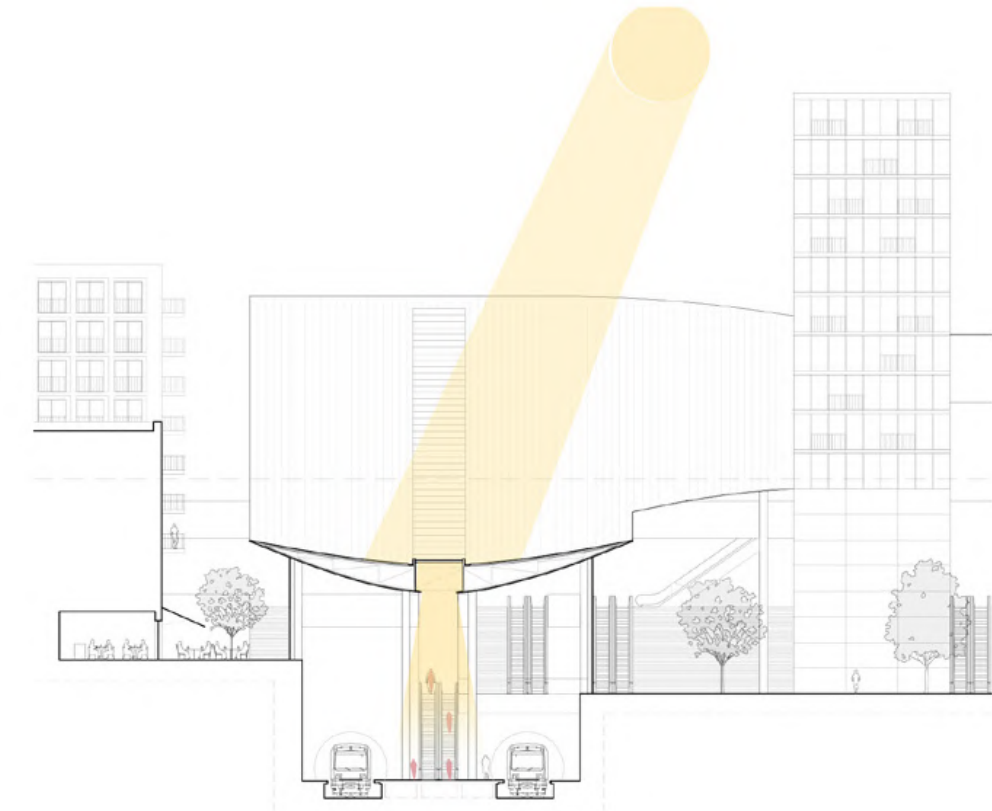

Connectivity Circulation

The design of the entrance of the station is driven by the concept of Connectivity – it aims to have connection between the two stations that is as effective as possible. This is firstly achieved by placing the stations directly underneath each other. The staircases are taking the most possible direct route, so that the change of the stations will not take longer than one minute.

The design also looks at the flow through the station and objects to achieve the natural movement. At the connection point this is done by the linearity of the flow, when at the entry point of the station the angles of the walls aim to direct people.

On the urban scale the entry part of the station connects to the public library building. The tower is located on the nod of the movements from and to both stations which is a winning position. The ground floor is occupied by the cafeteria, which gradually exposes to the library on the upper floors.

Circulation at the station is divided by two main principles – more public circulation, that has the constant flow of people going to the platforms and changing lines, and more private circulation, which involves the circulation of people, who use the offered facilities of new Kralingse Zoom.

User type A circulation is defined by stone pavement as well as stone staircases and more colder appeal. When user type B circulation becomes more intimate and soft by using wood as the main material. More intimate circulation is mainly present in the library, which becomes a central point between the square and the entrance to the metro station.

Design Relationship to the Roof

To underline the flow of the roof and keep it as a focus point of the station the walls are glazed. Glazed façade is used to achieve the light feeling of the station and not to create the feeling of being inside or underground, which was avoided by gradually stepping down urban scale platforms.

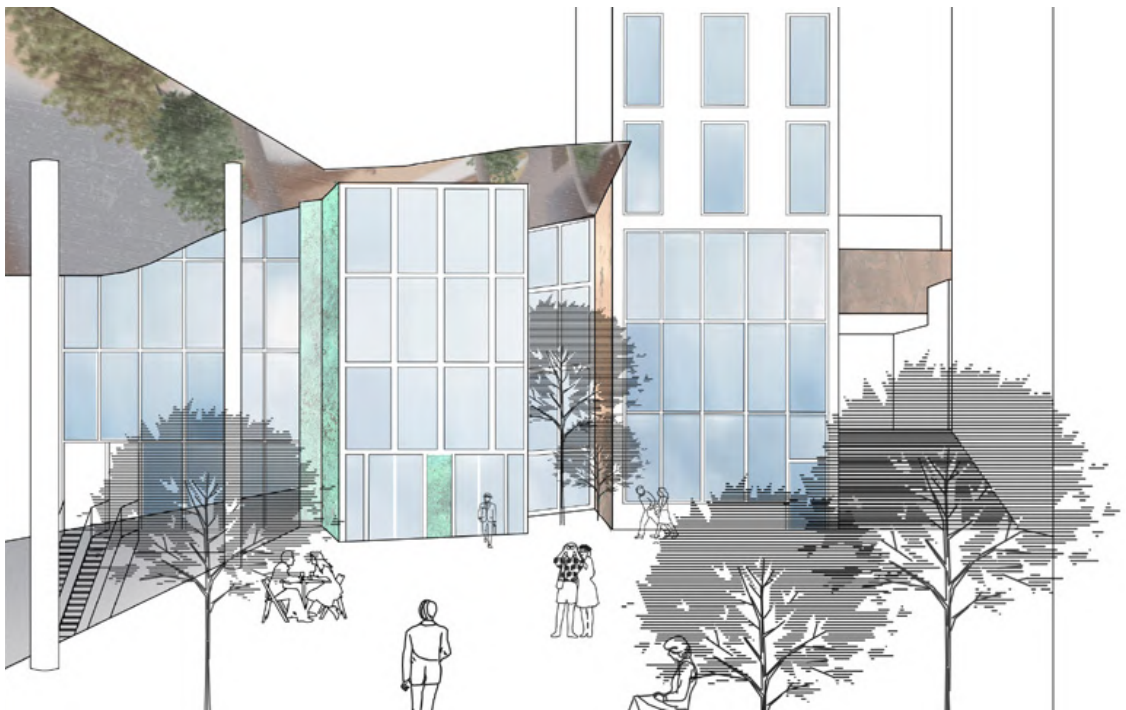

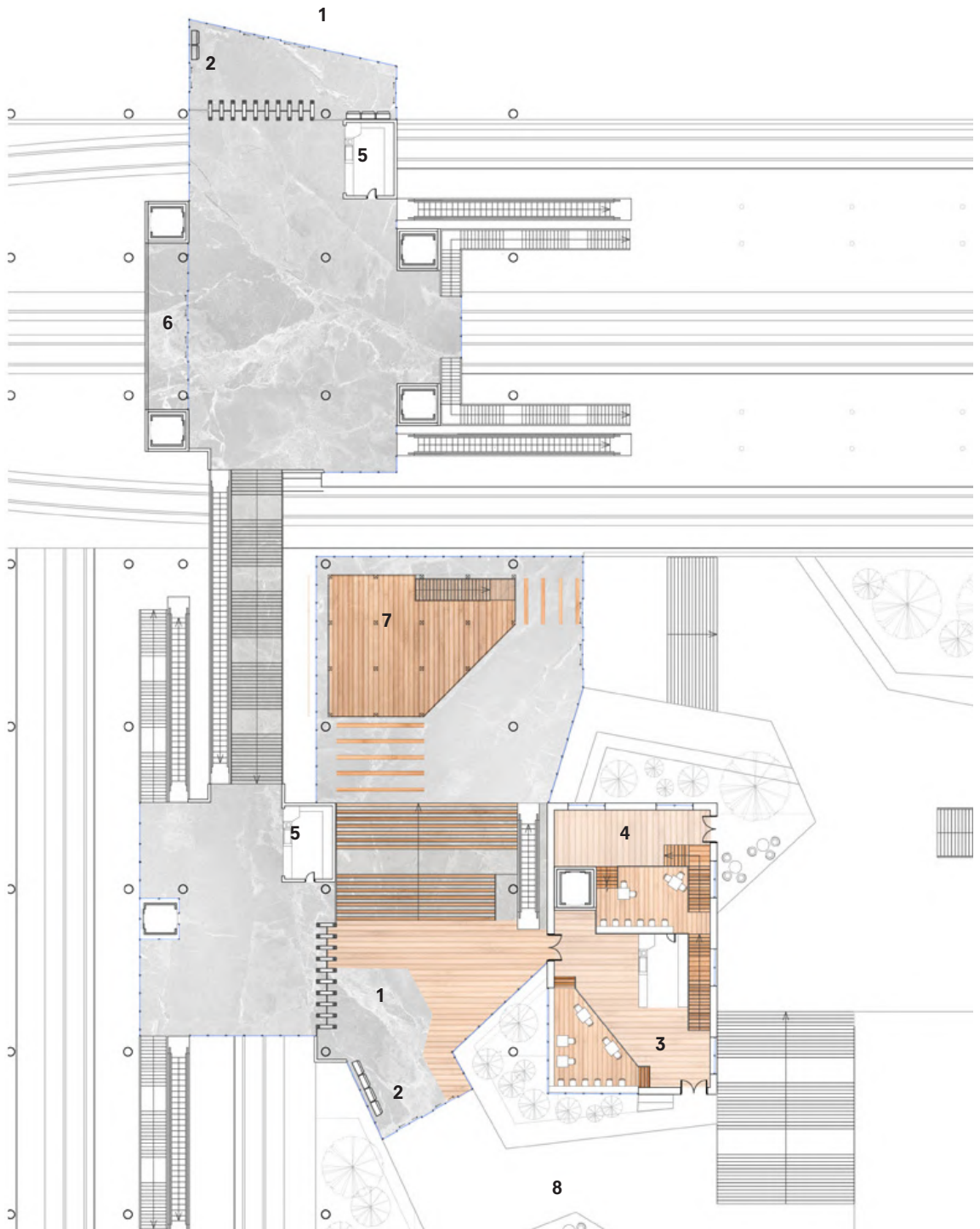

1. Station gates; 2. Ticket point; 3. Cafeteria; 4. Library; 5. Kiosk; 6.Store; 7.Flexible public space; 8. Public square



- ① Platform
- ② Circulation for stairs and escalators
- ③ Outdoor seating, tables and chairs
- ④ Pathway
- ⑤ Timber bench seating
- ⑥ Entrance
- ⑦ Station entry points

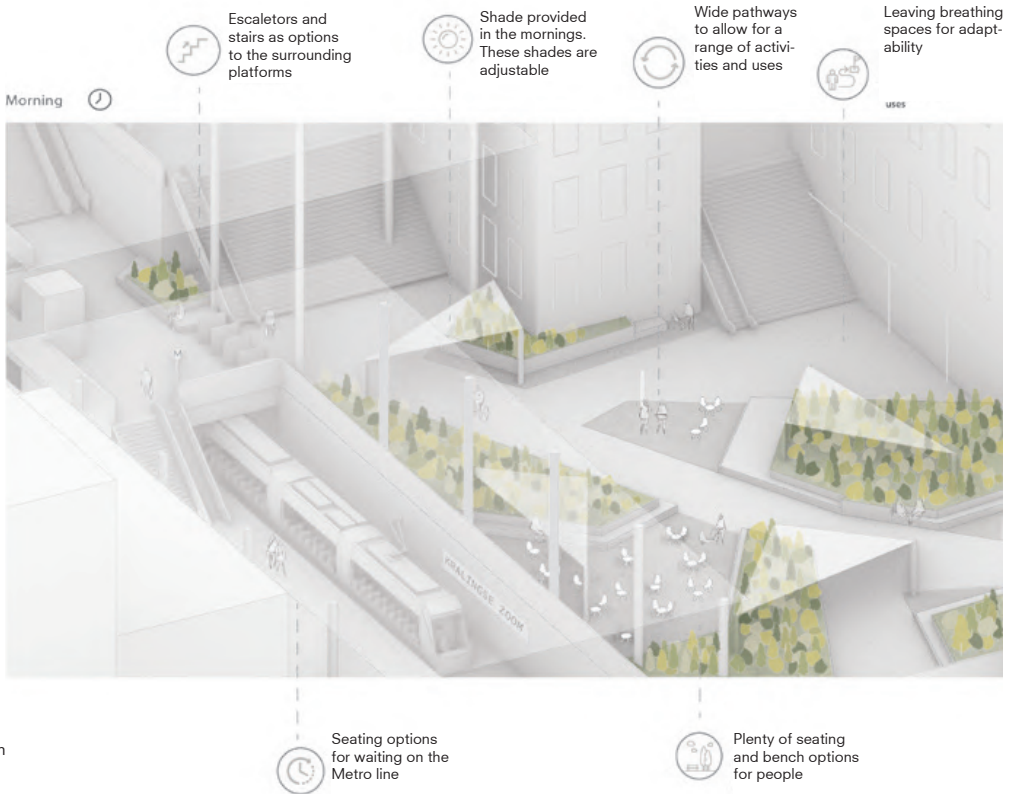

Illustration





ERG?...WHATIS?...SOCIALHUB?...WHAT...

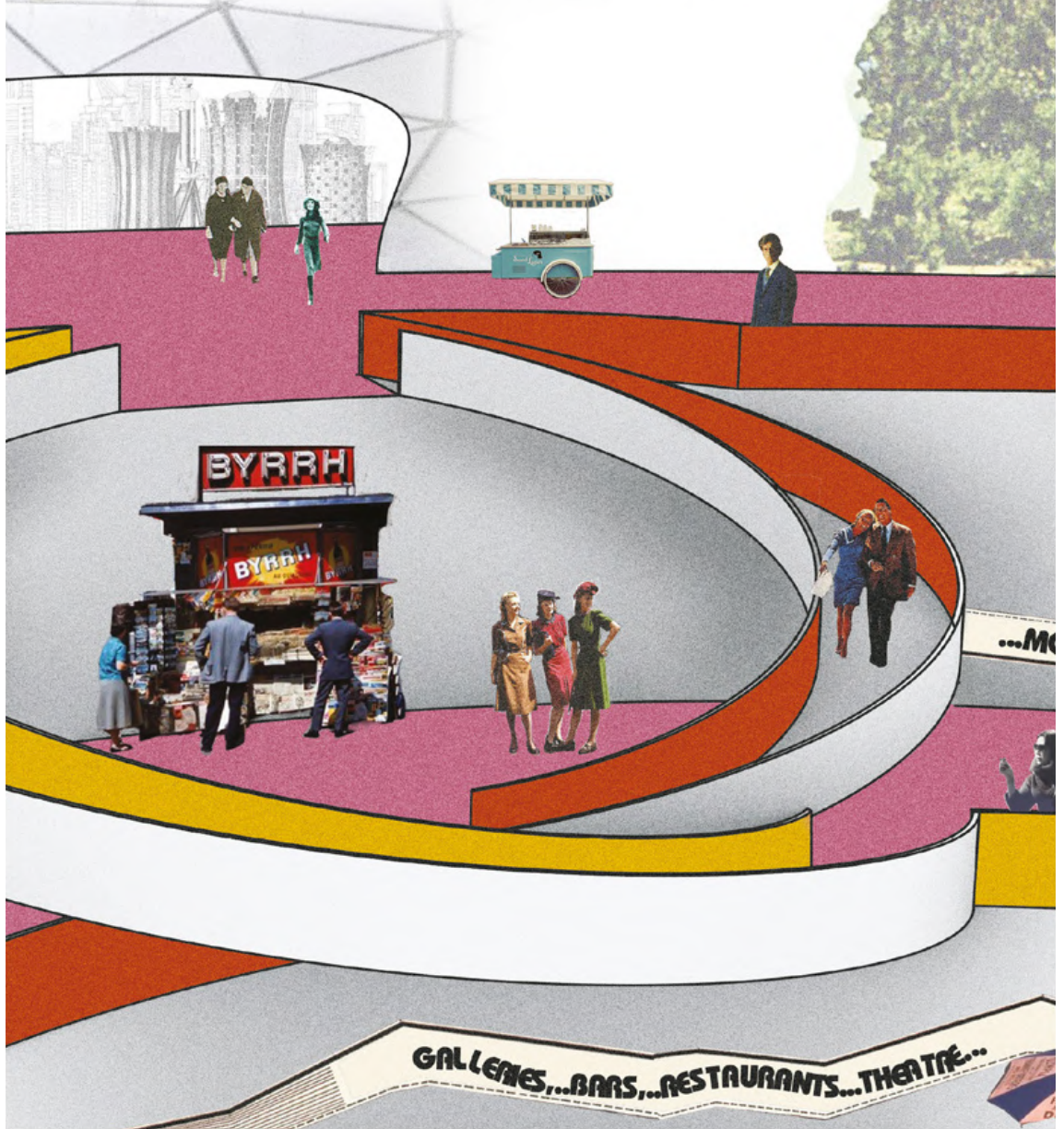

Kralingsberg 2030

Kralingse Zoom Station
Go Under!

Lorenzo Bondavalli
Jasmin Goldberg
Romy Weeteling

Analysis Outcome

Concept Summary

After considerable investigation of our site, Kralingse Zoom, the shortcomings of the area gave us insight into points of improvement. Five defining features were chosen for the site to give the area new life:

1. Future densification - The City of Rotterdam plans for the city, including our site, to act as a growth corridor with 15,000 new homes projected along the metro-line. Our station intervention will therefore have to accommodate for this growth in the area and it provides us with the opportunity to become the centre of this projected growth.

2. Network connectivity - The existing site already contains a station with metro, bus and park shuttle lines, and the network connectivity and centrality of the station will only increase with the addition of the circle line. It is therefore up to us to decide how to establish our station as a node within this vast network, and design in a way that influences how commuters will treat this station, be it merely as a place for transfer or as a destination within itself.

3. Car centrality – Currently there is a lack of pedestrian scale infrastructure and the prioritisation of the car due to the P+R at the station. However, the placement next to the highway A16 makes the location very easily accessible and offers a great public transport connection with the city centre of Rotterdam.

4. Social integration – The station should act as the meeting point for residents, commuters, students and office workers as well as bridging the income gap of residents of Kralingse and Capelle aan den IJssel. The position of the new station has therefore been carefully considered, placed at the nexus and meeting point of the existing demographics in the area.

5. Temporal nature - Significant peaks and troughs in use exist, with the station highly trafficked at peak hour during the weekdays by students and office workers but effectively deserted at night and during the weekend. This provides an opportunity to have the station and our new intervention as a “hub”, providing reason for people to use this site at the current troughs.

With deep consideration of these facts our group has come up with the concept of an “inverted skyscraper” or “ice-berg” station that wishes to fulfil the following goals. The form is also intended to be a provocation and a critique of current densification methods in Rotterdam. The concept aims to emphasise a pedestrian oriented future rather than being another addition of car scaled, isolating infrastructure. We believe that a lot of the current observed issues at the site and station is due to the segregation of uses and the view of the station as merely a stop along the morning commute.



Future densification

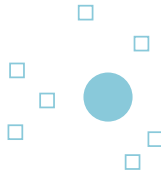

Low density

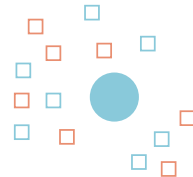

Medium-high density



Network Connectivity

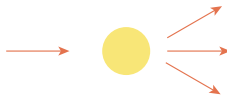

A-B

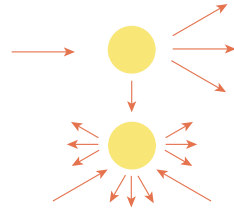

A-(A-Z)



Car centrality

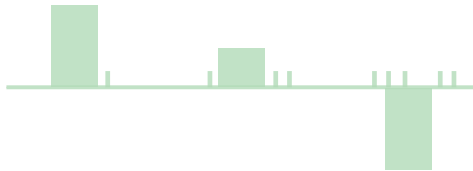

Car scale

Human scale



Social Integration



Segregation



Integration



Temporal Nature



Day



Day/Night

Observed segregated uses (existing)

Segregated zoning was observed at the site, with the residential, business (office park), transit and education (Erasmus University) sectors all remaining contained within their specific “zones”. This, we believed, was the main cause of the lack of atmosphere or activity during certain times versus a peak of activity at others.



We therefore wish to transform this idea of “segregated” zoning into a “gradient” zoning in which each different sector merges into the next, with the different uses and user groups influencing each other to create an integrated whole.

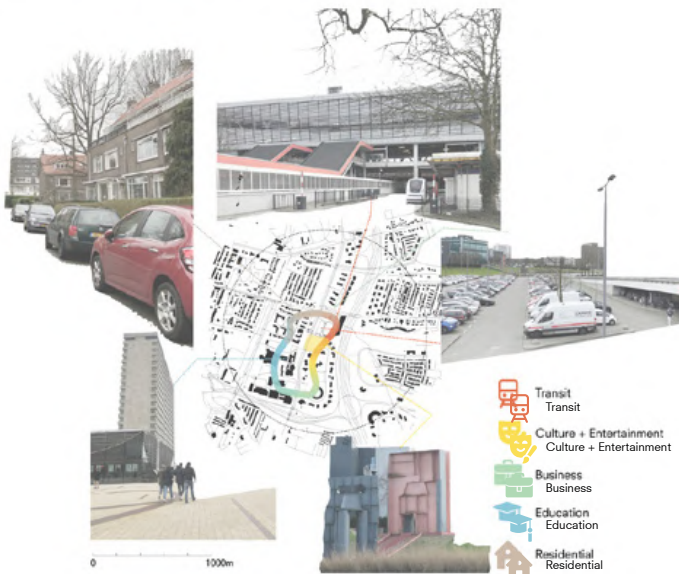

Investigating placement options

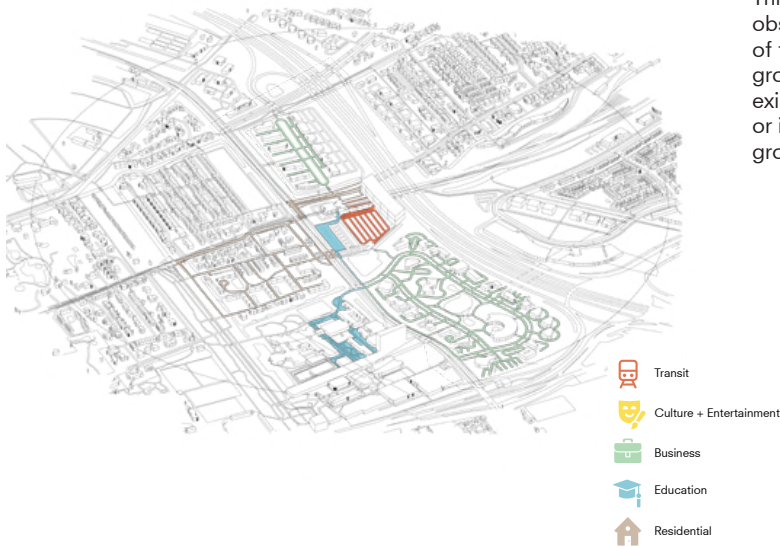

This segregated zoning can then be observed in the circulation patterns of the different user groups with each group taking a particular path to the existing station with little social mixing or integration occurring between groups.

Intervention as a NEXUS

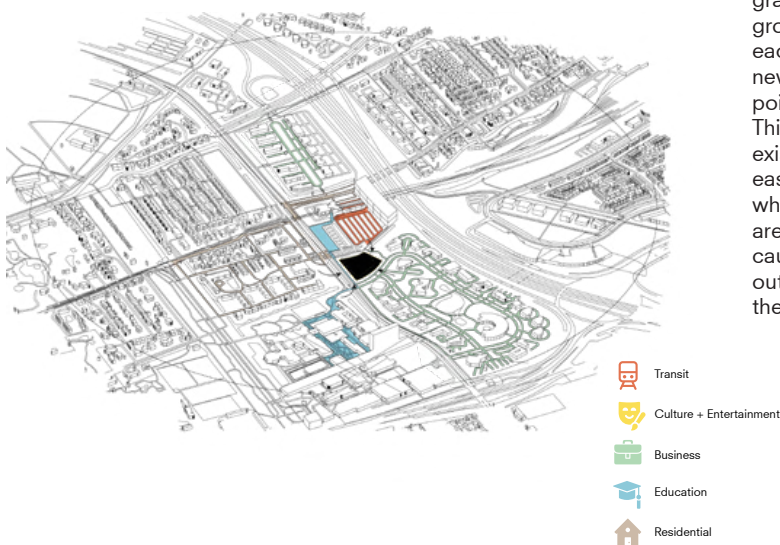

Therefore, in order to facilitate this gradient zoning in which the users groups actually mix and integrate with each other, it was decided to place the new station (addition) at the meeting points of all the different user groups. This places our station at the nexus of existing activity in the area, making it easy for all the existing users to meet at what will become a social hub for the area. The hope is that this would then cause the different user groups to bleed out from this central place and influence the area as a whole.

Kralingsberg 2030

Towards an underground society?

Our position focuses on ‘underground urbanism’ as a dystopian, alternative and provocative solution to the current alienating and densification trends. While this particular project looks at the potential applications of underground urbanism to Rotterdam and the Kralingse area in general, we all see this as a solution also in the broader sense, applicable to many large cities as population growth and densification become a reality.

In fact, we asked ourselves:

What if in 30 years there won't be any ground left? How can the environment adapt and expand, according to society needs? Where do we, as human beings, the protagonists of our cities and the ones who live them, stand in this process?

In the search to answer this question, we decided to exploit the chance offered by the elective: using the design of a station as a catalyst to stress and amplify, in a futuristic and speculative vision, the environmental and societal problems that we actually found with our first two weeks of research. We think in this way to make people reflect and to not give ready-to-build projects, but visions, ideas, lenses.

In defining and understanding our argument and approach we have created three separate mission statements: *Why go underground? How do we go underground? What can be the result of going underground? (Future speculation and application)*

Why go underground?

Densification is an inevitability for our site at Kralingse Zoom, with 15.000 new homes projected for the area by 2050. Furthermore, transport hubs and station creation have been seen in Rotterdam to be catalyst for (vertical) densification, meaning significant growth in this area over the next few decades. With the ever-expanding global population, a continuous demand for more housing also requests a change of our experience of the world. The first expansions included the suburbs, the finer area developments. However, at one point the expansions reached its limit as free land got sparse. The next step of densification became the skyscraper. Whereas the density of the population is concentrated on a smaller piece of land. As the skyscraper meanwhile forms a well-known image of a city, the human-scale in these developments get lost. The large buildings overhang and deprive users of sky views. We imagine a future where this (predominantly residential) densification will occur according to the current patterns of skyscrapers, with further reduction of usable public ground space in the area and creating a congested above ground environment. Furthermore,

it was observed already that the current site is not built to the human scale, car infrastructure dominating the area and creating quite an alienating environment to pedestrians. We see this as only being furthered with classic densification methods and therefore propose a subterranean extension and addition to the existing station to create a comfortable, human scaled experience for the residents and users of the area. While the building is becoming the main focus of the investigation now, we see the creation of our KralingseBerg as only one part of a larger puzzle and masterplan for the area. By starting to introduce the building as a social hub, which draws people in through meeting the need of currently absent amenities and facilities in the area (including the demand for a new metro line), a start of a bigger social system is started in the KralingseBerg. This introduction to underground environments prepares the users for a larger future subterranean social system underneath the city of Rotterdam. Together with the adaptive character of the building, its surrounding also shapes itself to its future demands. In imagining a future which transits to car-less by 2050, we see the gradual usurping of the car park by green public space, and the creation of vertical urban farming and a farmers market in the car park building. Finally, we see the soon to be redundant highway becoming a high-line, transforming itself from a border to a bridge that can connect the residential communities on the eastern side of the station to the new transport and social hub created with our intervention.

What can be the result of going underground? (future speculation and application)

The examples of Helsinki or Montreal Underground Cities, show how they created underground systems with every function the society needs. The result is not just one building, but a network of functions, as it is possible to see looking at the Montreal Underground City Map, with all colours of different functions. What if, in the case of Kralingse Zoom, it wasn't just a building, a spot, but an underground living system? Can it incorporate better the existing station not just with a tunnel, but everything than becomes part of a bigger plan?

Concluding:

- Can we provoke, speculate, maybe translating (dystopically) these ideas to the context we have to work on? How can we translate these ideas to Architecture?
- Thinking outside the box, could our Station be an explorative catalyst, just a piece of a bigger system that will be a response of our analysis and that will incorporate the existing station?

HIGHWAY
HIGHLINE

DENSIFICATION

DENSIFICATION

DENSIFICATION

KILL THE CAR ZOSO !!

PARKING → FARMING

UNDERGROUND "SOCIAL SYSTEM"

ALTERNATIVE VEHICLES

HUMAN CENTER

WALK

BIKE

WALK

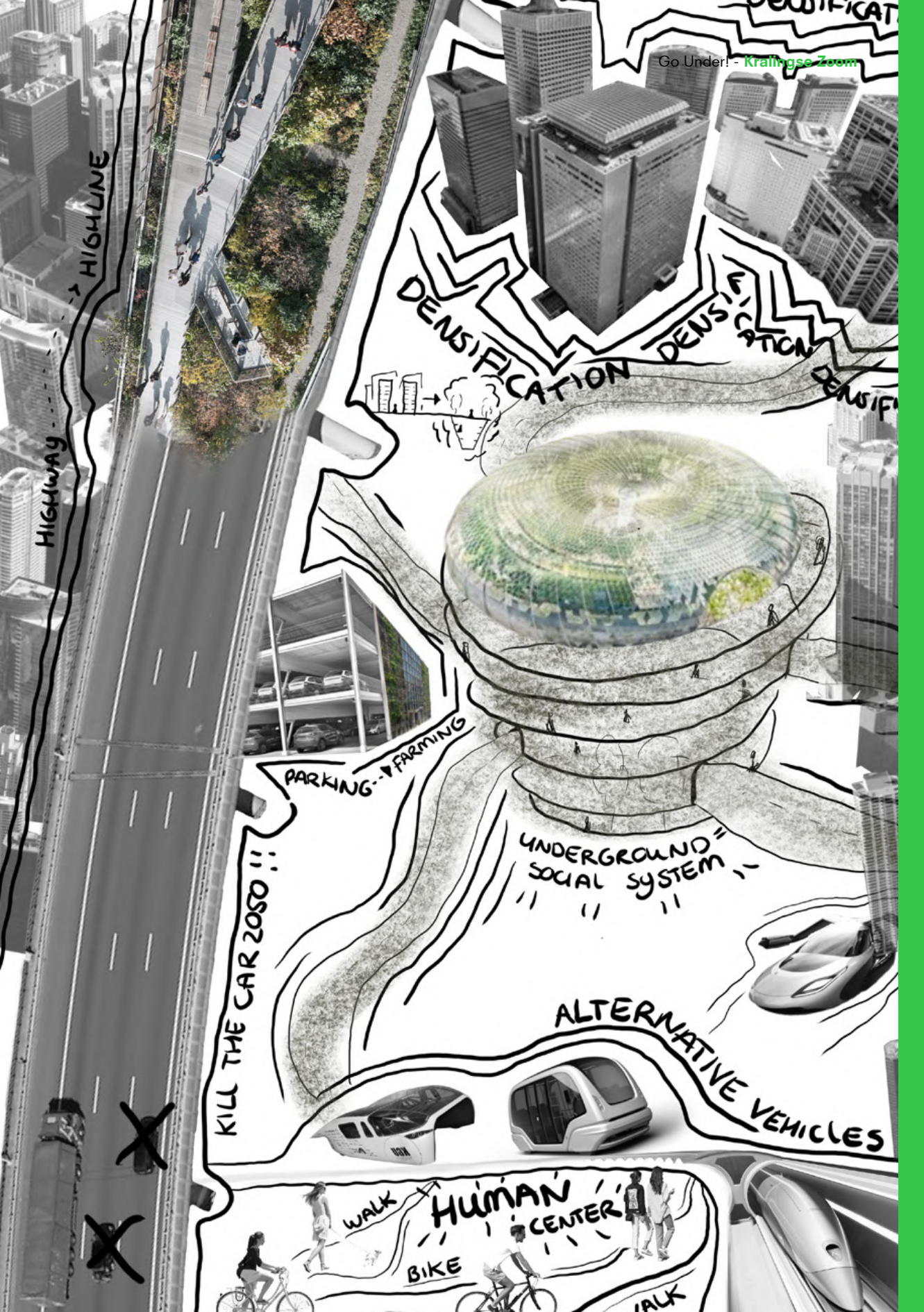









How?

Underground Concept: The Mirror

The concept for the design of our subterranean system at Kralingse Zoom is to create a “mirror” of the existing above ground functions. We hypothesise a future where the area has densified to the point that the future development needs go underground. However rather than merely being a singular underground element we wish to create an underground system.

In order to do this, we propose that this system reflects that on the ground plane, thus being contextually

relevant to the area while also assisting in a sense of acceptance and orientation to the users, given that it reflects their above ground experience.

In mirroring the surface world underground, both the major axis as well as the major activity centres are taken into account, creating a network of nodes and connections that reflects the existing nodes and connections on the site.

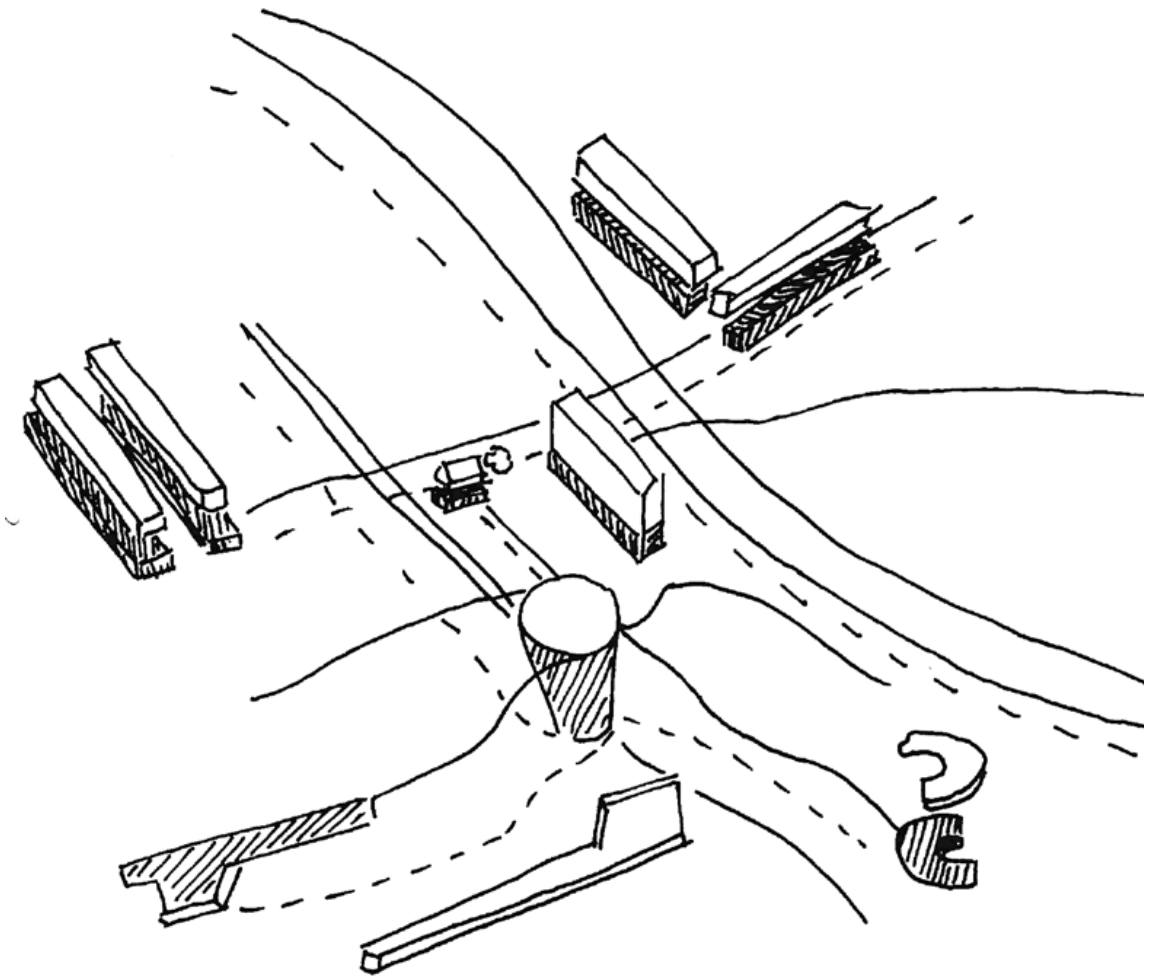

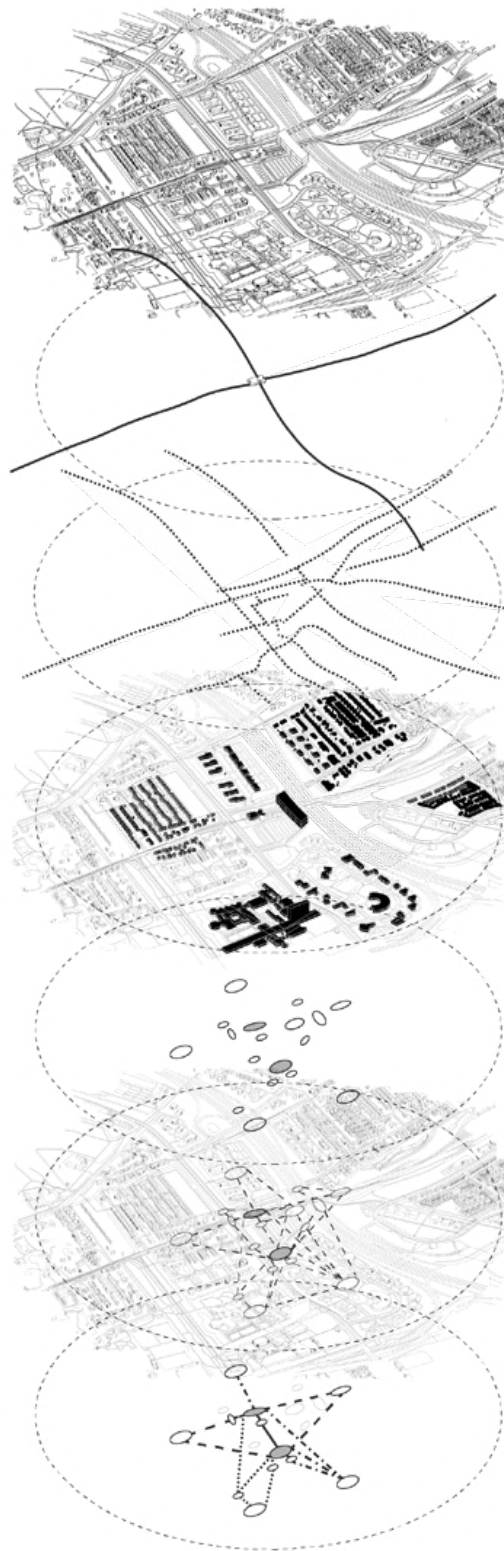

EXISTING CONTEXT

> KRALINGSE ZOOM

RAIL NETWORK

> EXISTING METROLINES (EW)
AND ADDITION OF CIRCLE LINE
(NS)

PRIMARY SITE AXIS

> CONVERGING ON A
TRANSP AND SOCIAL HUB

**LANDMARKS AND
ACTIVITY CENTRES**

> RESIDENTIAL ERASMUS AND
BRAIN PARK

NODES

> PLACED AT ACTIVITY
CENTRES AND THE
INTERSECTION OF MAJOR AXIS
WITH DIFFERENT SIZES
DEPENDING ON USER GROUP,
DENSITY AND FUNCTION

CONNECTIVITY

> BASED ON BOTH EXISTING
AND PREDICTED INTERACTION
BETWEEN USER GROUPS AND
ACTIVITY CENTRES

USER PATHS

> HYPOTHESED PATHS OF
TRANSPORT USERS IN THE
AREA, DIFFERENT SPEEDS,
DIFFERENT JOURNEYS

WHY? - CONCEPTUAL SECTION WHAT? SUBTERRANEAN URBANISM

UNDERGROUND AREAS ARE LESS SUSCEPTIBLE TO EXTERNAL INFLUENCES AND BETTER WITHSTAND NATURAL CATASTROPHES.

Slung City - Yona Friedman

WHEN THE PARKING GARAGE GETS VACANT - ADAPTABLE TO BECOME A FARMERS MARKET / URBAN FARMING

UNDERGROUND CITIES MAKE ABOVEGROUND PARKS POSSIBLE

EXISTING STATION DERGROUND FASTTRACK CONNECTED TO NEW METROLINE

COURTYARD SPACES HELP TO PROVIDE A REFERENCE POINT IN WAYFINDING AND ORIENTATION

TREES CREATE A SENSE OF ENCLOSURE, INTIMACY AND COMFORT IN LARGE SPACES.

COMPLEXITY CREATE HUMAN SCALE AND ENHANCE EXPERIENCE

NEW SUBTE

Washington DC Metro System

Oxford Circus Underground Metro

Spiraling city plan Auroville

Plug-in City - Peter Cook

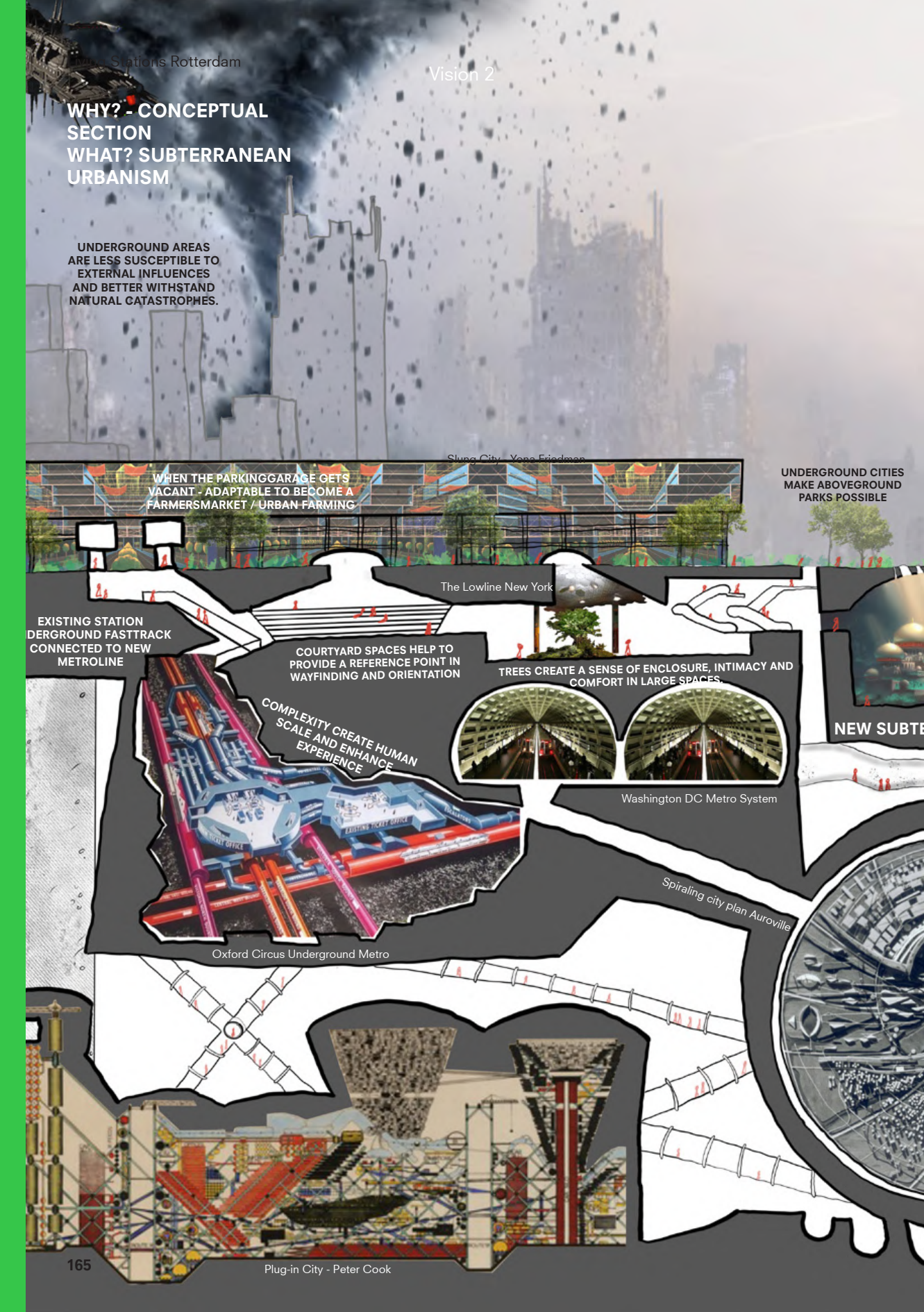

DYSTOPIA

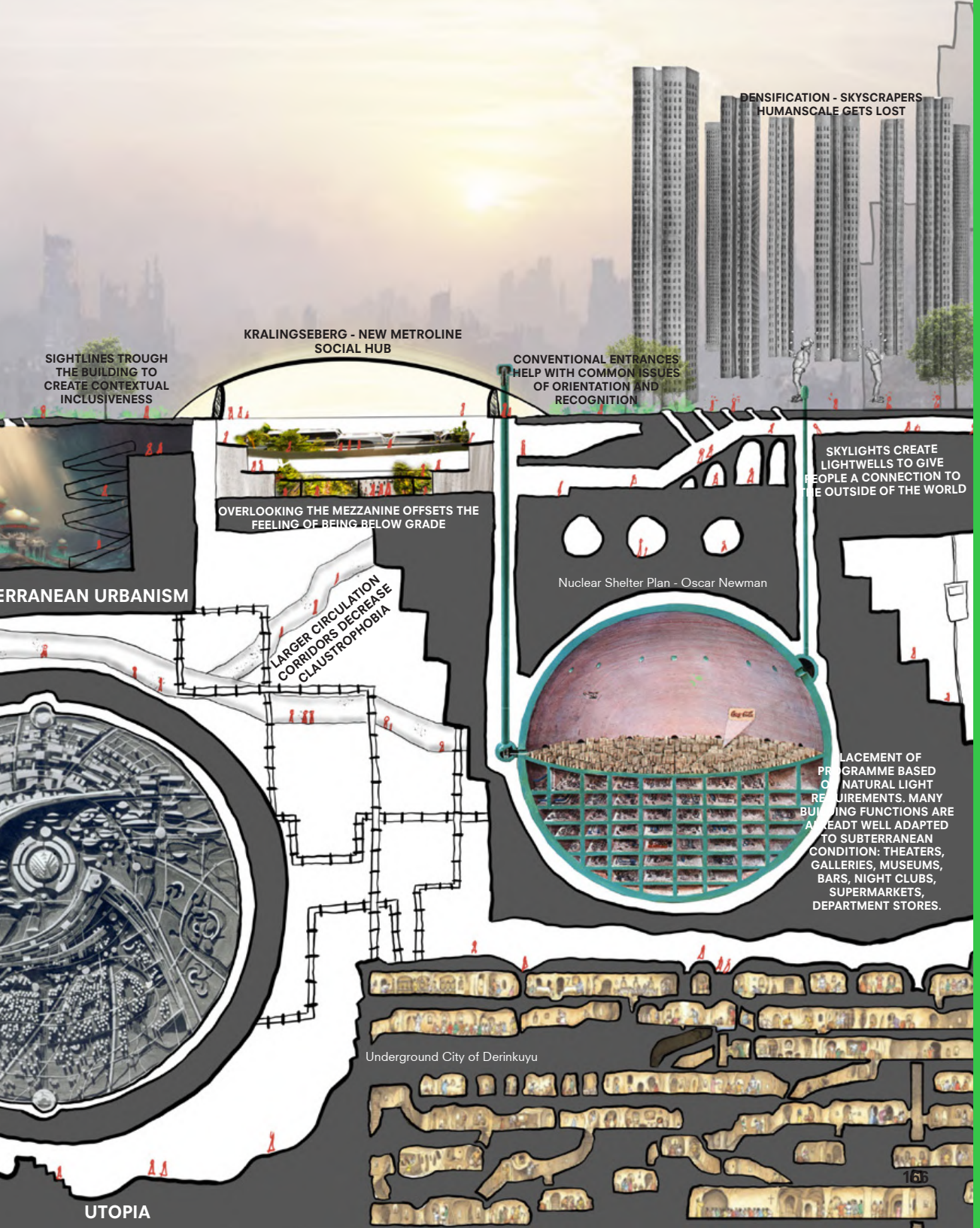

**DENSIFICATION - SKYSCRAPERS
HUMANSCALE GETS LOST**

**KRALINGSEBERG - NEW METROLINE
SOCIAL HUB**

**SIGHTLINES TROUGH
THE BUILDING TO
CREATE CONTEXTUAL
INCLUSIVENESS**

**CONVENTIONAL ENTRANCES
HELP WITH COMMON ISSUES
OF ORIENTATION AND
RECOGNITION**

**OVERLOOKING THE MEZZANINE OFFSETS THE
FEELING OF BEING BELOW GRADE**

**SKYLIGHTS CREATE
LIGHTWELLS TO GIVE
PEOPLE A CONNECTION TO
THE OUTSIDE OF THE WORLD**

ERRANEAN URBANISM

**LARGER CIRCULATION
CORRIDORS DECREASE
CLAUSTROPHOBIA**

Nuclear Shelter Plan - Oscar Newman

**PLACEMENT OF
PROGRAMME BASED
ON NATURAL LIGHT
REQUIREMENTS. MANY
BUILDING FUNCTIONS ARE
ALREADY WELL ADAPTED
TO SUBTERRANEAN
CONDITION: THEATERS,
GALLERIES, MUSEUMS,
BARS, NIGHT CLUBS,
SUPERMARKETS,
DEPARTMENT STORES.**

Underground City of Derinkuyu

UTOPIA

Programme & Use

Extensive analysis of the relationships, desires and routines of the hypothesised users were taken into consideration when determining the programme and connections for the system at large.

Four user profile were created, the commuter, the student, the worker and the resident, to determine how they might use the station and its surroundings. In hypothesising these narratives, it was determined that there would be different "speeds" of use, with the commuter experiencing a "fast track" journey while others may take full advantage of the programme on offer in the system. Of course, the four journeys exhibited are only a small sample size, when in reality there would be workers that wish to take their time and explore bars and galleries, and alternatively students who wish to go straight from the station to the university and back. However in order to provide a clear example, two different users were defined in the central axis, a "slow track" commuter's journey and a "fast track" one.

Furthermore, the changing nature of the users and programme with time was considered, as demonstrated in the schedule of uses diagram. As is clear, the peaks in commuter traffic occur during peak hours, while other activities peak at alternating times, dining at meal times, clubbing in the late hours of the night and culture (galleries, museums and the like) peak between the afternoon and evening. These ever changing uses and programme allow the system to adapt to the needs and desires of its users at different points of the day and solidifies the area as one to be used at all times of the day, not periodically as currently occurs.

- COMMUTERS
- STUDENTS
- - - - - OFFICE WORKERS
- EATING
- - - - - DRINKING
- - - - - CULTURE
- CLUBBING

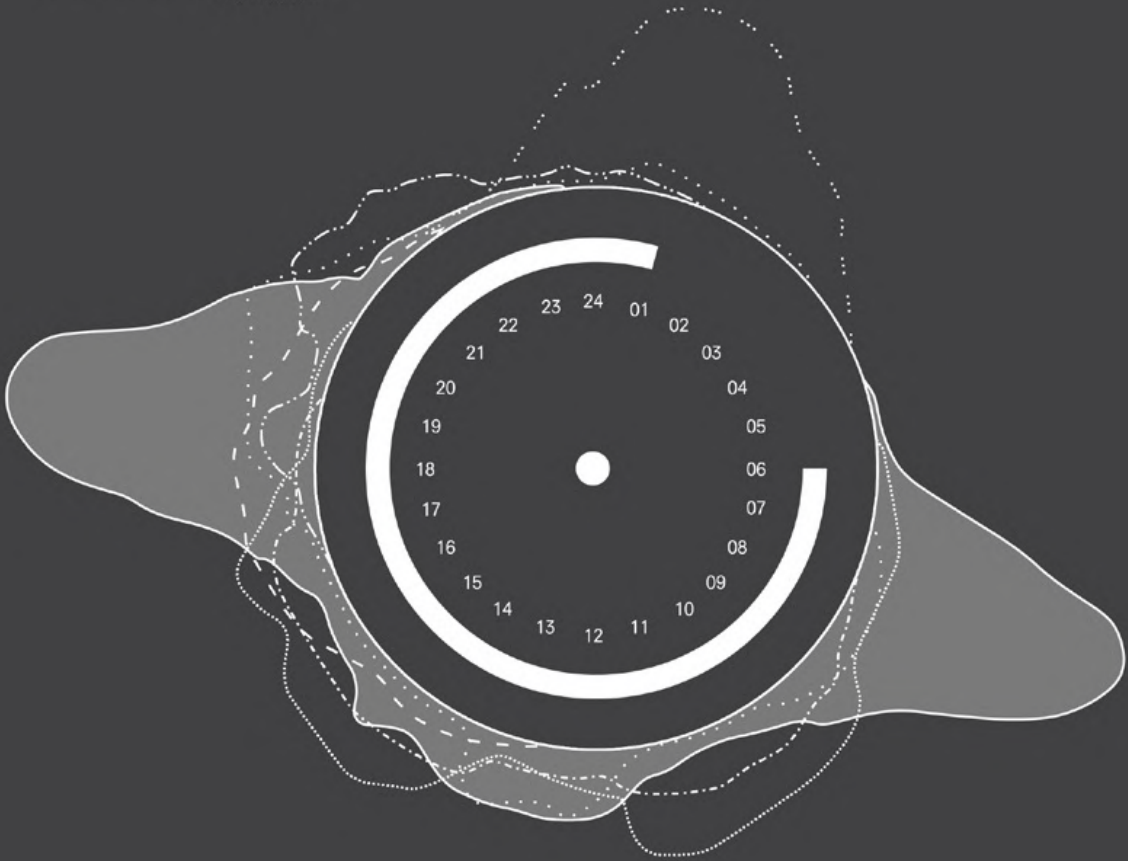

User Journeys

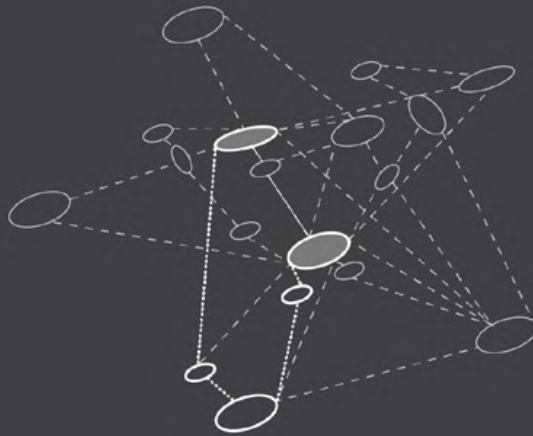

COMMUTER TRACK

STUDENT'S JOURNEY

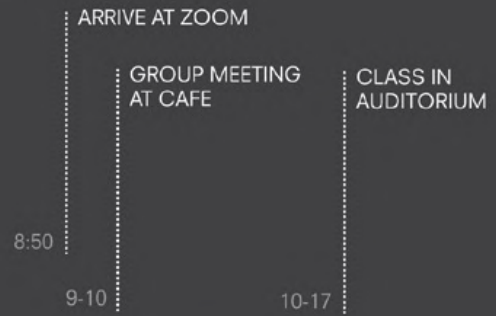

RESIDENTIAL TRACK

OFFICE WORKER TRACK

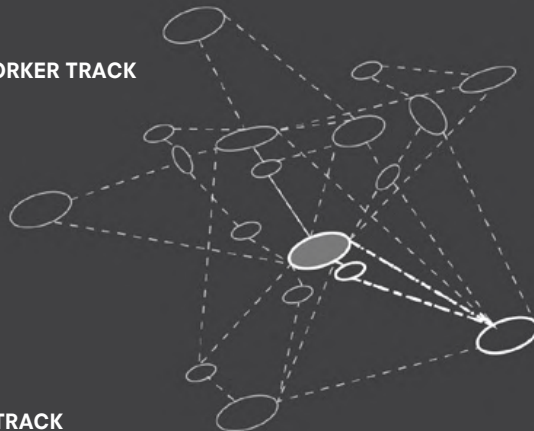

STUDENT TRACK

WORKER'S JOURNEY

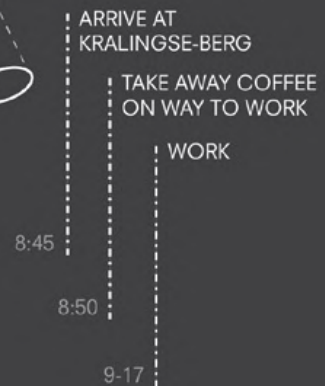
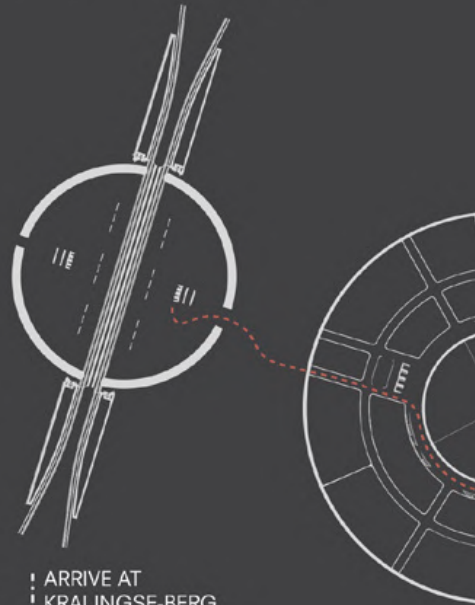

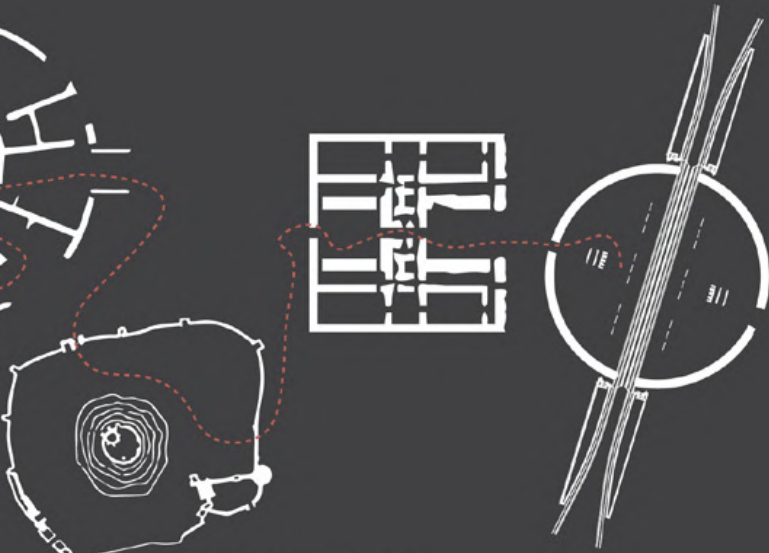

AFTER CLASS DRINK
WITH FRIENDS

RETURN TO FRIENDS
HOME ON CIRCLE
LINE

17-19

19:15



DINNER WITH
COLLEAGUE

GROCERY SHOP-
PING FOR HOME

RETURN HOME VIA
CIRCLE LINE

17:15-19

19:15-45

20

Circulating in an 'under-grid'

Public ground space is progressively being eaten by urbanisation, leaving citizens disoriented, without the possibility to live and in a way 'produce' the space they belong to, as Henri Lefebvre already 50 years ago previewed. Can we as architects, planners, engage ourselves in order to experiment innovative solutions, that go beyond a mere building and can adapt according to the society needs? From here the willingness to give to the city of Rotterdam a new vision, a new 'underground urbanism'. But what stays behind this phantomatic word?

The aim of my individual research has been exactly understanding how to delineate and confer an empirical shape to an (maybe utopian) ideal concept, focusing on how circularity is a key step in the efficiency of a new space. I wanted to challenge myself trying to provide to the community of Kralingse-Zoom a 'system', on which the society could grow and then be constantly implemented and expanded. But before even thinking about what could have been a possible design outcome, I wanted to get back to the definition of 'urbanism'. The term was born with the Ildefons Cerdà in the middle of the 19th century. His intent was to create an autonomous activity focused on the 'spatial organization' of the city. This is the reason why people started to move to the cities from rural areas, to be part of a 'living organization'. From here the idea to ground this new world on a skeleton, an 'under-grid'. An immediately orienting and recognizing system, in which hopefully millions of people and an entire communities every minute will cross through, needs an organization. (Also a future plan needs an organisation).

This grid, with a module of 16x16m, is a direct reflection of the spatial analysis conducted in the area, with the main flows and accesses of the future users of this station, providing to each of them the chance to safely enter the system. This grows and connects the chosen position for the new Metro-line Station and the existing Kralingse-Zoom one, creating a main 'spine' on which secondary paths and multiple functions face. This underground axis allows the users to live an experience that provide them everything that they need and feel part of a developing society. Circulation has been divided in 'slow-track' and 'fast-track'. Choosing the former, a longer and more articulated path crosses multiple functions, offering meeting and amusements opportunities. With the latter, pure commuters can reach immediately the faster path trough the various 'vertical circulation' channels placed in crucial coordinates on the ground.

Since the aim of this individual exploration was creating the 'skeleton' of this project, this design at times hangs on a thin line between the conceptual and the physical. On this line, my group mates will ground the 'perceivable', going into a more detailed representation of the atmospheres. Just because of this subsequent dependency, i wanted to confer to this 'skeleton', that includes even ventilation and humidity controls channels, the readiness to host 'plugged' entrances and multi-functional spaces that will bring further the design (only passing the approval of the 'under-grid').



↑ | M A B C

↑ Schiedam Centrum
Schiedam Centrum
DE ARRES

A Schiedam Centrum min

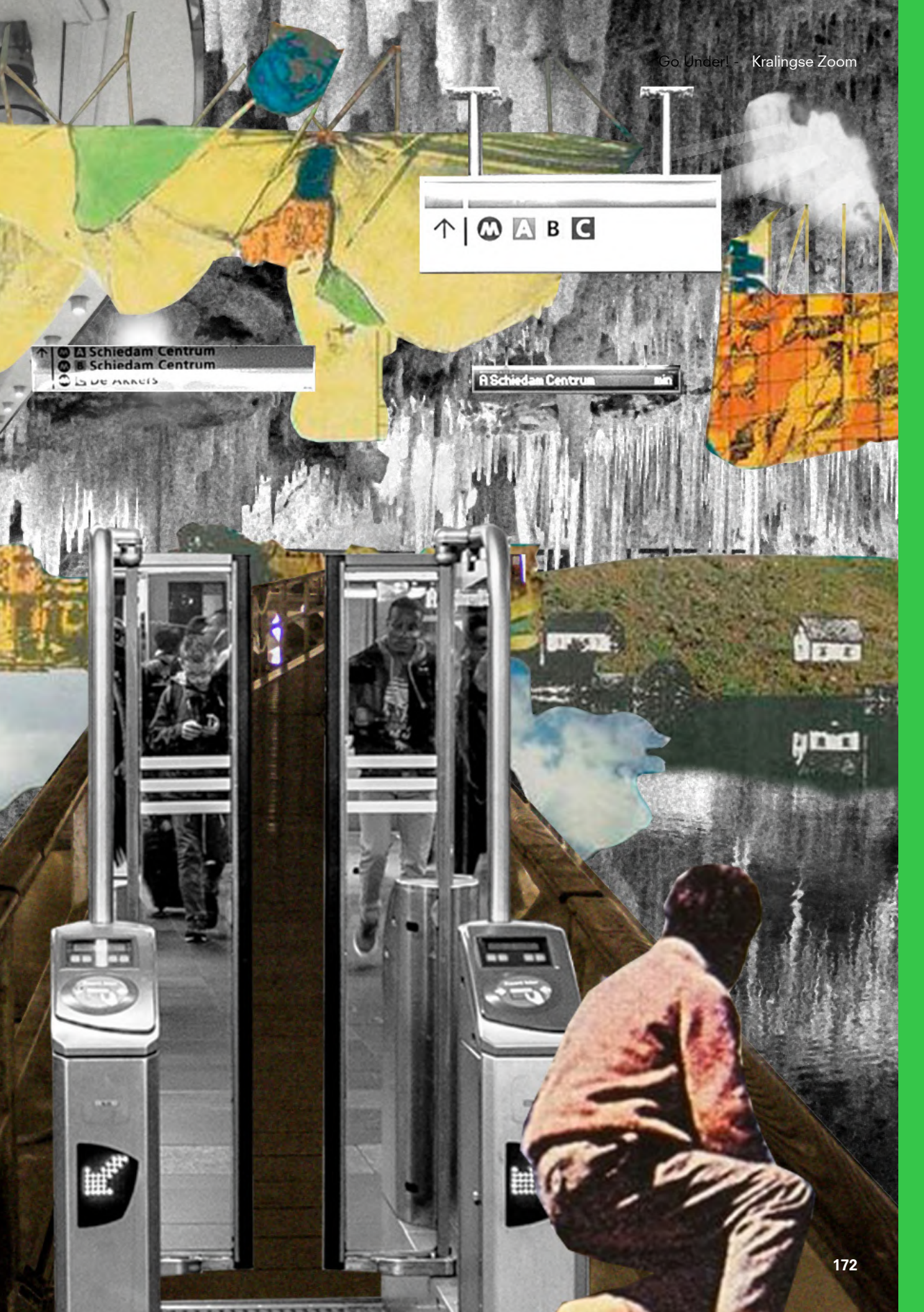

The 'Skeleton'

Analysing the main axis helped in delineating the grid and understanding the best location for the most efficient placement of the access points, as well as the connecting overall system. Exactly as the spinal column with surrounding ribs.

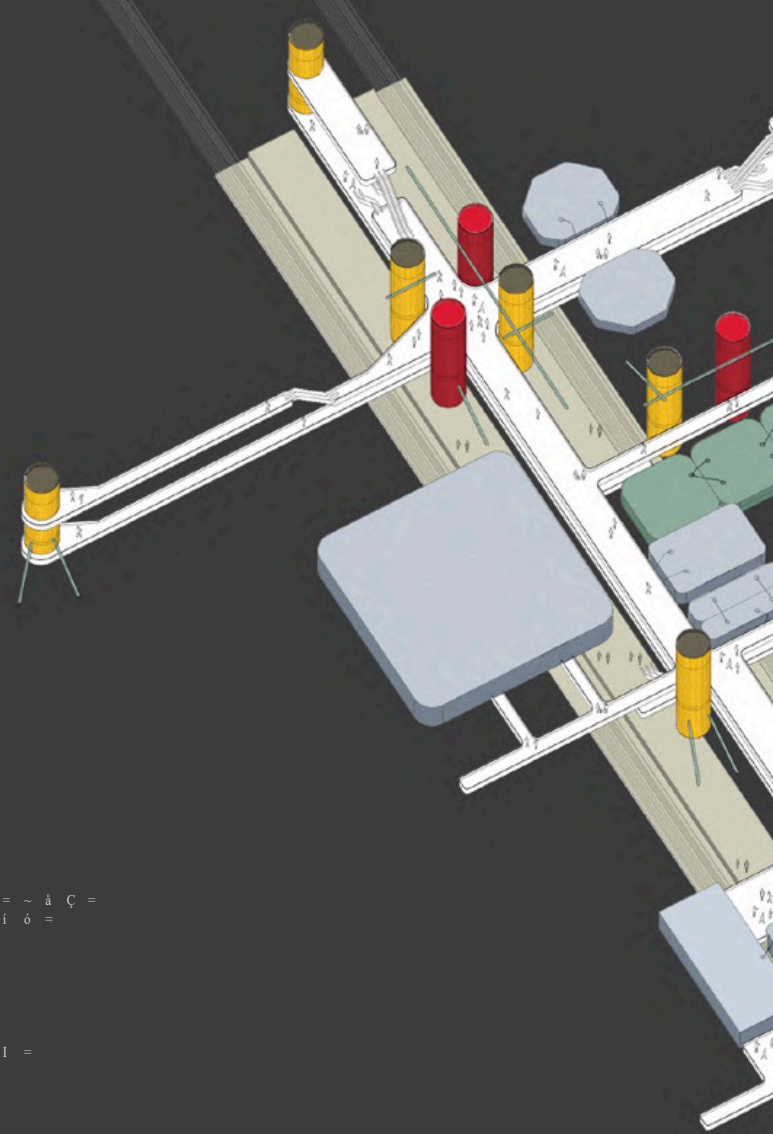

í É è í á Ä ~ ä =
 Á á è Á í ä ~ í á ç ä = ~ ä Ç =
 ~ Á Á É è é á Ä á ä á í ó =



í É è í á Ä ~ ä =
 í É ä í á ä ~ í á ç á I =
 Û í ä á Ç á í ó =



ä É í è ç J ä á ä É =
 é ä ~ í Ñ ç é ä



Ñ ~ è í = E Ä ä í É F = ~ ä Ç =
 e ä ç í = E Ö è É É á F =
 í è ~ Á ä =

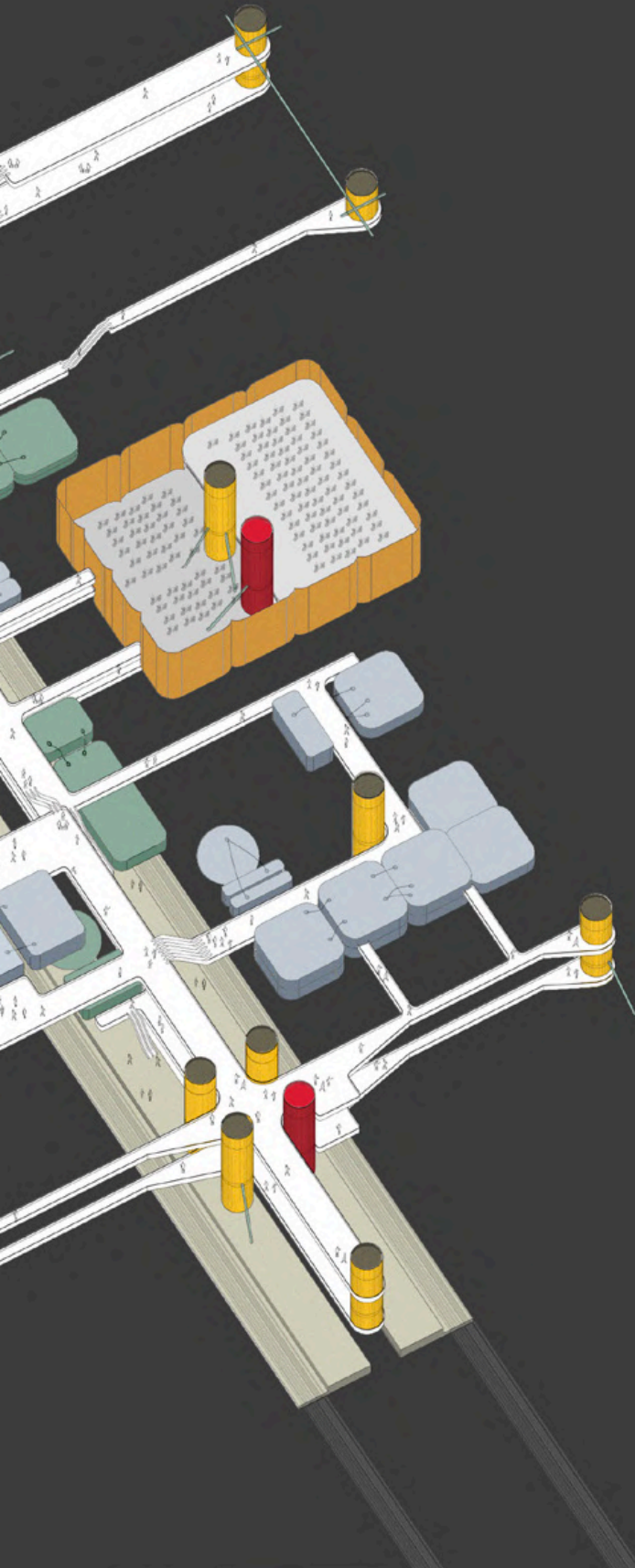

Hurry up! Here's the fast-track

A straight path allows user to move directly from Kralingse-Zoom to the metro-line and vice-versa in less than 5 minutes, maybe just grabbing some quick food at the grocery shop. With both escalators and elevators it is possible to reach immediately the platforms at -24m level, or climbing straight up to the above ground.

Enjoy your slow-track

The first two levels under ground are destined to the slow-track circulation. Multiple functions are placed along the path to offer the citizens all that they need, leisure spaces, shops, auditoriums. The grid of functions is extremely flexible and it could be easily expanded, in case of increasing need of space.

Entrances + Interfaces

Hesitations are often related to the design and realisation of large subterranean urban structures. It is therefore important to do so in a way that is responsive to the human scale and mitigates common fears about lack of light and ventilation, claustrophobia and disorientation (Carmody and Sterling, 1984).

For my individual design task and research, I have decided to explore the entrances related to our system, and more specifically the primary axis between the existing Kralingse Zoom metro station and our addition of the “Kralingse-berg” underground circle line. I believe that through careful consideration of the design of entrances and the interface of our underground system with the existing ground plane, many of the concerns related to underground architecture can be combated.

One of the primary arguments to go underground is to create a human scaled, comfortable environment counter to that created by a forest of skyscrapers and thus through the design of my entrances I wish to make the most of the freed ground plane.

Specifically I have explored 3 main entrance conditions:

- Entrance 1: from the ground plane into “Kralingse-berg”.
- Entrance 2: from the ground plane into a subterranean public space.
- Entrance 3: from an underground connectivity tunnel to a subterranean public space.

In doing so, the main design considerations were about how to create human scale comfort and interaction in the transition from spaces of different size and spatial experience. It has shown from research that complexity, enclosure, transparency and imageability (or the creation of detectable and recognisable patterns) can assist in creating this individual level experience and comfort (Ewing and Handy, 2009). These entrances and interfaces aim to increase ventilation, penetration of natural light into the underground spaces and provide a sense of orientation and connection with the exterior.

While Entrances 1 is unique to its specific condition, Entrance 2 & 3 have been designed as a “kit of parts” in which several options are provided which can then “plug” into the larger system as required.



ENTRANCE TYPE 3
- OPTION D -

ENTRANCE TYPE 2
- OPTION C -

Plug-in System

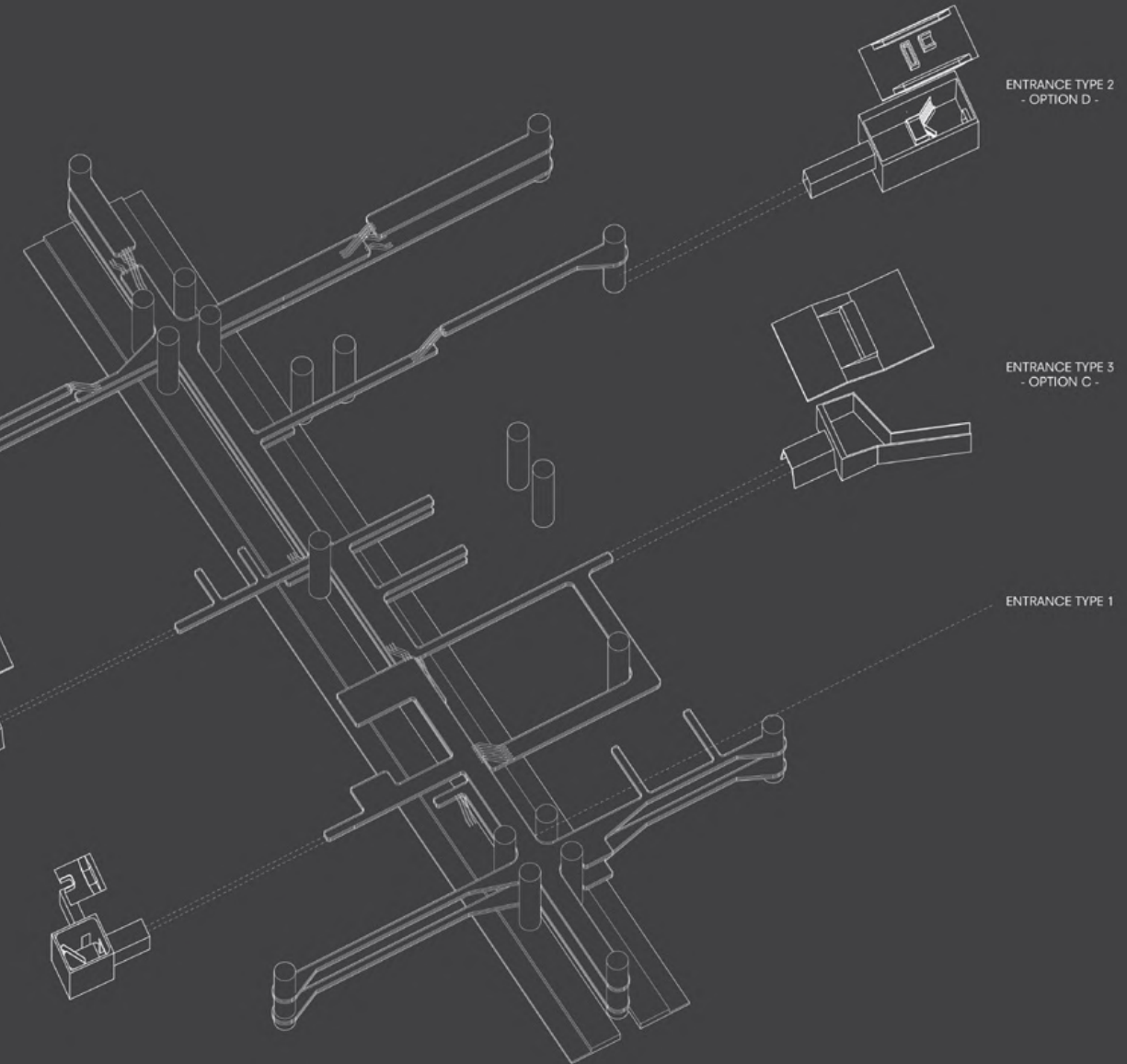

Entrance 2

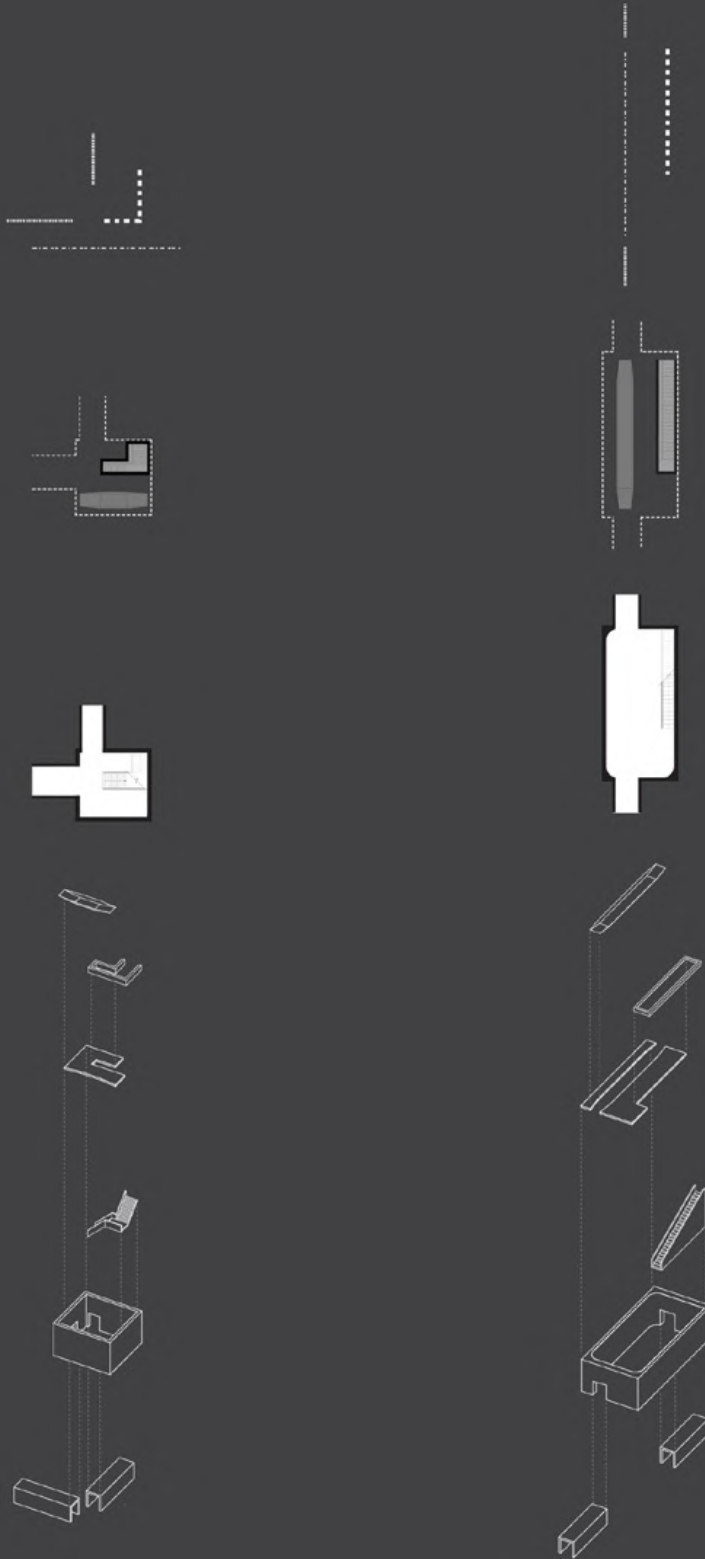



Option C

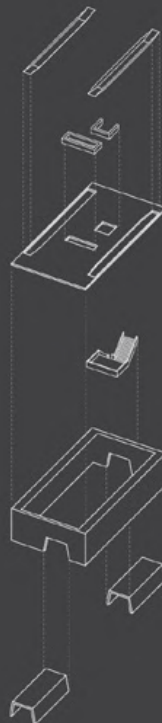

Option D

Analysis of axis of travel

- > entrances ■ ■ ■
- > connecting system 〰〰〰〰〰〰
- > ground plane movement - - - -

Roof Plan

- > barriers and street furniture
- > recessed walk ways to connect with below

Floorplan

- > enclosure and entrance

Vertical circulation

- > follows the axis of movement for increased orientation

Walls

- > enclosure

Tunnels

- > provide connection with the wider system
- > 1960s = streets in the sky
- > 2030s = streets in the ground
- > potential for commercial opportunities branching off tunnel circulation

Human Scale within the Atmosphere of the Experience

Within this individual research, I look back at the previous design statement: the future densification resulting in a landscape of skyscrapers disregards the human scale. A subterranean space within this landscape of skyscrapers offer as well aboveground public space as a comfortable space underground. Within the previous concept the conditions of a comfortable subterranean space are stated and are integrated in the following experiences of several examples of functions within the new subterranean urbanism of Kralingse Berg (pg 134). This concern statements such as:

- Trees create a sense of enclosure, intimacy and comfort in large spaces;
- Larger circulation corridors decrease the feeling of claustrophobia;
- Skylights create light wells to give people a connection to the outside of the world;
- Courtyard spaces help to provide a reference point in wayfinding and orientation.

These statements are tested in the experience of an auditorium, a kindergarten, a convenience store and the public square of the new metro line within the grid of the underground city.

Colour Psychology

Together with the above stated conditions of light, space and furniture, the idea of colour psychology has been applied to the individual rooms. Colour is the most effective transmit of information combined with emotional value. As the manipulation of feelings by colours is individual, a small test prior to the choice of the final colour is shown alongside this text whereas this collection of coloured scenes could bring up different feelings for everyone. Nevertheless, some average feelings coordinated with the colours of the rooms can be found and are explained per example.

Considering a new way of future underground living and working, the comfort of these spaces are guaranteed and shown in the experience of the atmosphere of the example functions in the next pages. Try to fit yourself in the human scale of the room in the collage and imagine the emotion the colour of the room brings up within yourself!



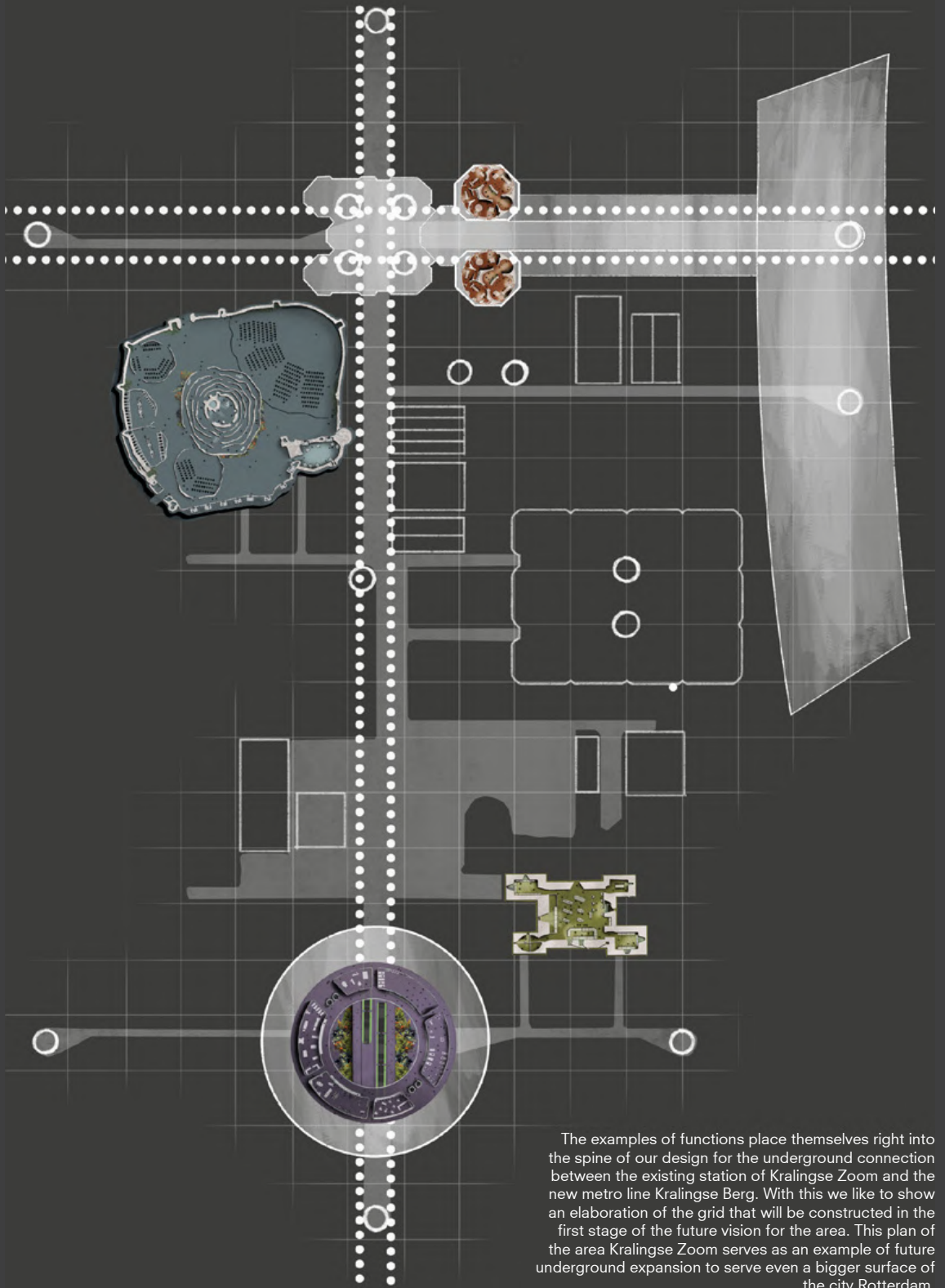

The examples of functions place themselves right into the spine of our design for the underground connection between the existing station of Kralingse Zoom and the new metro line Kralingse Berg. With this we like to show an elaboration of the grid that will be constructed in the first stage of the future vision for the area. This plan of the area Kralingse Zoom serves as an example of future underground expansion to serve even a bigger surface of the city Rotterdam.



Auditorium

The auditorium serves as a final destination within the grid of Kralingse Berg to accommodate big lectures as well as conference meetings. Therefore the room operates as a place of knowledge, calms you down or inspires you. The cool tones of the blue colour palette together with the light wells, high ceilings and private spots to withdraw yourself, makes the auditorium a reassuring spot to spend an extended period of your time studying.

Blue: serenity, neutral, calmness, timeless

Perspective of Auditorium
Collage



Floor plan of auditorium

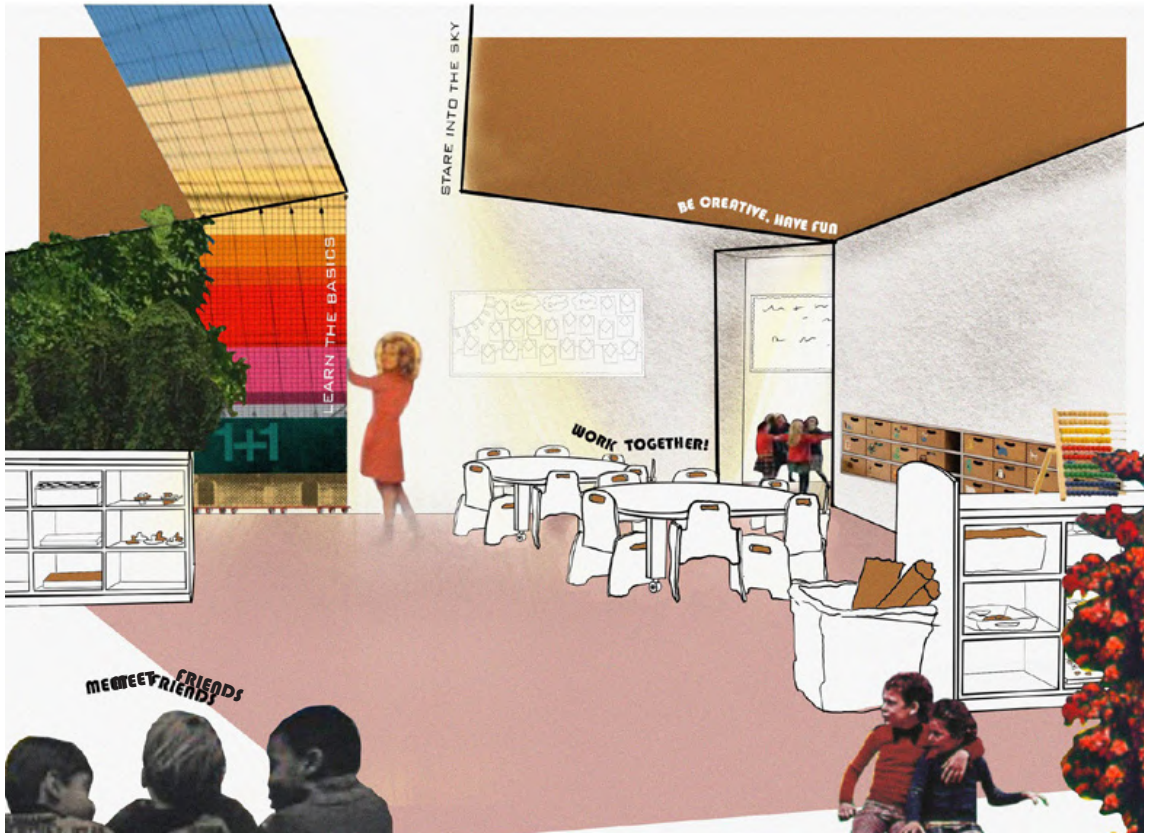

Kindergarten

Within this fast society, your busy job, cooking for the family, now and then even going to the gym: the kids are taken care off! Within the subterranean city the kids get dropped of at kindergarten whilst you get the groceries at the store at the other ends of the tunnel, meet your boss at the auditorium or travel to the city centre. The orange rounded kindergarten looks after the kids within a warm, soft and inspiring space. To learn, to play and to meet.

Orange: energetic, stimulation, warmth





E

ERASMUS

Collective Research Location & Characteristics	187
Conceptual Scenarios Visions	201
Centrifugal! Rings	203
Centripetal! Erasmus Park	227

Coen Jager
I-Hsuan Lee
Sofia Pavlova
Birte Zacharias
Julia Linde
Maxwell McGrath
Siddharth Agarwal
Sofia Pavlova

Site History

Historical Timeline

In the beginning of the 20th century the site was only polder landscape embarked in dikes.

Beginning in 1950, some roads started to develop amongst a few facilities and some housing. The centre of Rotterdam is situated west of the site, so the programme in this day is mostly consisted out of recreative and secondary facilities.

From 1975, the highway A16 develops and facilities disappear to make room for housing and the university. The main roads are being developed, the former main road now serves as a secondary road.

Starting in 1993, more of the Erasmus campus is being developed as well as the Brainpark. The Metro line for Kralingse Zoom is also being realised.

From the 2000s, the entire area is densifying. Within a short period of time, the Brainpark and campus are finished. The former main road now forms a barrier between the park and campus area.

Between 2010 and 2020, there are no major changes. Some projects are being demolished or renovated. Student housing is added, as well as some new facilities and buildings on campus. The biggest and most recent project was the parking plaza on the university campus, realised in 2018.



1850



1900



1950



1975



2000



2010



1900



1950



1975



2000

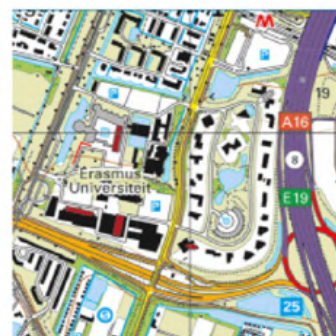

2010



2020

Demography Kralingsen Oost/Esch Comparison

In terms of housing, more houses are uninhabited in Kralingen Oost, and there is about 30% more single family houses. Both the areas have about 95% of their dwelling built before 2000.

In terms of health, Kralingen Oost scores better, they sport more, smoke less and have less overweight, where as in the Esch almost 50% of the people there have overweight.

Another high difference is seen in the ownership, in Kralingen Oost 45% is rented, where as in the Esch that is almost 80%

The biggest difference is in the property value, Kralingen Oost properties are on average €478.000, in the Esch this is €159.000. This is also seen in the average income, citizens in Kralingen Oost earn on average €42.400, the Esch €24.000

The functions in both areas are around equal, where Kralingen Oost has of course the Erasmus university so more educational functions.

In terms of the inhabitants themselves, it is seen that there are more younger people in Kralingen Oost of the age between 15-25, probably due to being near the Erasmus university. Both areas have an increase of inhabitants since 2013.

Erasmus University Research

This research is based on the official numbers provided on the website of Erasmus University Rotterdam. From 2016 to 2018, not only did the amount of the foreign students rise but also the number of the overall students. It is estimated that in the future there will be more students studying in this university. The potential crowd in the future is one of the aspects we need to take care of in the design phase.

Another aspect to notice is the sexual rate of the university. According to the information provided by them, the female staff working in the university is about 55% and the male 45%. Same rate happens in the proportion of female students and male students. These percentage show that there are more women in this university than men, so the female friendly concept should also be taken into consideration in the design.

ERASMUS UNIVERSITY ROTTERDAM

QS WORLD UNIVERSITY RANKING
#183

QS SUBJECT RANKING
#21

GRADUATE EMPLOYABILITY RANKING
#141-150

TOTAL STUDENTS - 31,149

INTERNATIONAL STUDENTS - 5,787

TOTAL FACULTY STAFF - 3,742

POPULATION COMPOSITION

 DUTCH STUDENTS  FOREIGN STUDENTS



 STUDENTS

 STAFF

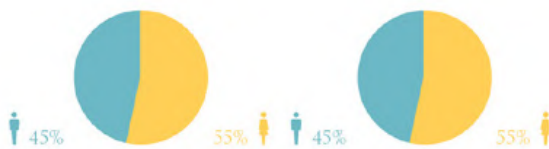

FACULTIES

&

STUDENT NUMBER

ECONOMICS 6,402	LAW 4,860	SOCIAL & BEHAVIORAL SCIENCES 4,547	PHILOSOPHY 796	INTERNATIONAL INSTITUTE OF SOCIAL STUDIES
HISTORY, CULTURE & COMMUNICATION 1,863	HEALTH POLICY & MANAGEMENT 1,170	ERASMUS UNIVERSITY COLLEGE	ERASMUS MC 3,571	ROTTERDAM SCHOOL OF MANAGEMENT 6,686

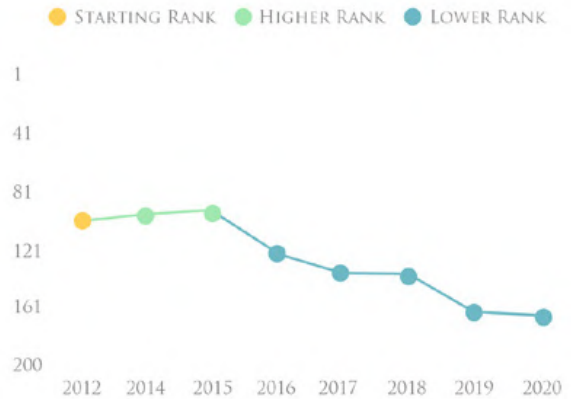

2016 REGISTERED STUDENTS:

BACHELOR'S DEGREE ENROLMENTS 17,364
MASTER'S DEGREE ENROLMENTS 10,683

2017 REGISTERED STUDENTS:

BACHELOR'S DEGREE ENROLMENTS 18,912
MASTER'S DEGREE ENROLMENTS 10,877

2018 REGISTERED STUDENTS:

BACHELOR'S DEGREE ENROLMENTS 20,367
MASTER'S DEGREE ENROLMENTS 10,782



- EDUCATION
- COMERCIAL & INDUSTRY
- SPORTS
- RESIDENTIAL

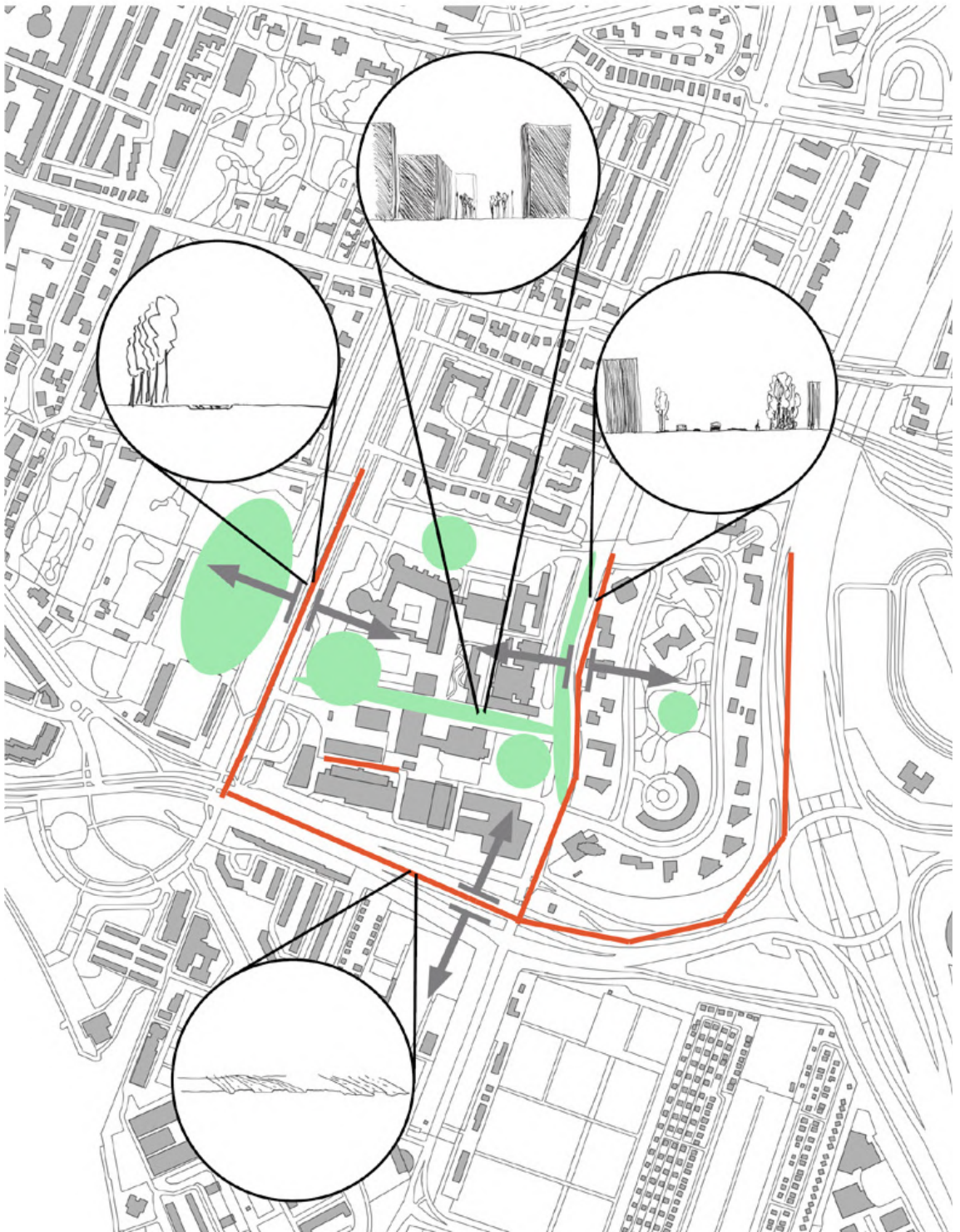

● OPEN SPACE — SPACIAL BOUNDARY ↔ MISSING CONNECTION

Erasmusstaete



Business Ensemble



Family Houses



Tinbergen Building



Sweco Building



Portiekwoning



Sanders Building



School of Management



Significant Buildings

Woudestein Monument

The main EUR complex (formerly NEH), completed in 1968 is also known as the Woudestein Monument. The main architect of the campus buildings was Cornelis Elffers. It consists of the library, Theil Building (lecture hall building), Tinbergen building (administration building), the auditorium and the sports building. This complex is a cluster of buildings representative of stark concrete brutalist architecture of the sixties and seventies.

As part of the master plan, a renovation programme of these historic buildings of Monument Woudestein was commissioned to Gerard Frishert in 2004 the main objective being to increase the capacity and modernise without compromising the original architectural character.

The Tinbergen Building

Tinbergen building is the main building of the Erasmus University, Woudestein complex. The high-rise building is 78 meters high and rests on a table construction of heavy concrete columns of 0.90 by 1.80 meters. It has a rigid central zone and two stiffening walls at the ends. There are round steel columns in the façades that are clad with concrete for fire resistance. The floors consist of an assembly of steel beams and prefab concrete slabs.

Architect: Cornelis Elffers
Construction Period: 1963 - 1970
Architectural characteristics:

The building has a characteristic Brutalist architecture from the 1960s. The façade of the building has powerful horizontal lines. The building stands as a solid monument on the campus.



Aerial View of Erasmus University Campus
1970



Tinbergen Building

Theil Building

Theil Building functions as lecture hall building. Just like the Tinbergen building, it also follows Brutalist style.

Architectural characteristics:

It features concrete frames around the windows on the long south facing façade, taking inspiration from by the architecture of Le Corbusier. The concrete frame function as passive sun blinds, called 'brise soleil'. The building houses classrooms and lecture halls.

Architect: Cornelis Elffers

Construction Period: 1963 – 1970

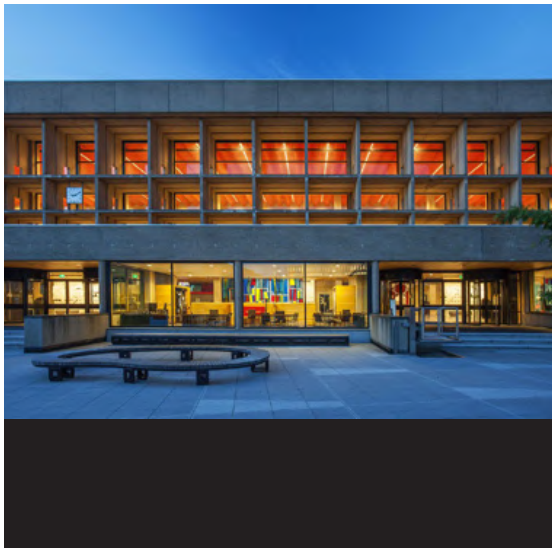

Theil Building

Library Building

The University Library that architect Elffers realized in 1968 is a municipal monument. After the renovation work completed in 2017, it now houses around 900 study workplaces, around 50 flexible office workplaces and book collections. The reading island on the adjacent pond has been restored to its former function.

Architectural characteristics:

A selection of natural materials and colours that blend with the original building and fit in with the other renovations of the Woudestein monument: walls and columns in exposed concrete, frames of black steel, grey epoxy floor and black carpet, slatted timber ceiling (oak) and metal coffers (light bronze).



Library

Auditorium Building

Within the Erasmus University Campus, The Aula is the only building solely designed for conducting ceremonies such as the Opening of the Academic Year. The first design of the building dates back to the 1962. Designed as an octagonal auditorium it can make space for one thousand people

Architect: Corns. Elffers and A. van der Heyden



Auditorium

Erasmus Pavilion

The new Erasmus University Student Center is located at the heart of a new master plan for the University area, where the two axes of the campus intersect. It is intended to become a vibrant and central meeting point on the campus. Sustainability, usability, transparency, and intimacy are the main objectives for the design of the Student Center.

Architectural Characteristics:

The building has an “egg-in-a-box arrangement” which preserves the transparency of the building by positioning all “dark space” programs that require an absence of daylight in the core of the building. The appearance of the building continuously changes depending on the events inside the building and the weather. Through opening or closing the dynamic lamella, users can determine how much daylight comes in. This leads to a reduction of the energy consumption as well as enables one to adjust the level of openness of the building.

Architect: Powerhouse Company + DeZwarteHond



Erasmus Pavilion

Brainpark I

Brainpark I was built around 1990, to accommodate start-ups close to the university. It was inspired by comparable parks near American universities like the Massachusetts Institute of Technology (MIT) in Cambridge. But, with these ambitions, Rotterdam proved too far ahead of its time, and these spin-outs of the university never materialized.

Architectural Characteristics:

The Brainpark I consists of archetypal offices built in the late 1980s and early 1990s. The area is mono-functional and no diversity, with business services and ICT as the main activity. Along with mostly large office buildings, the area also houses the Novotel hotel, several health care facilities and a temporary branch of the Rotterdam University of Applied Sciences. It is also characterized by a park-like structure, with a large water feature with several small bridges and meandering paths in the centre of the area.



Brainpark 1

P+R Kralingse Zoom, Rotterdam

ZJA designed a more than 175 meter long and 6-storey high building with an open character and a striking aluminium slat façade, with high ambitions regards the appearance as a striking business card for the entire area, and with light, colour and use of materials playing an important role.



P + R Kralingse Zoom

Predominant Materials

Campus - Brainpark - Pavements

This map shows the predominant materials used in the area, both in the Erasmus University Campus and in Brainpark I, and their distribution on the site.

In the Campus buildings, the main materials are concrete and brick, both in different shades of brown. Concrete is mainly present in the constructions located in the north of the main pedestrian street as an example of the use of concrete in the Brutalist architecture from the 60s - 70s.

Brown brick is more present in the south of the campus. Apart from this two main materials, the campus boasts later constructions using high tech materials such as folded aluminium sheets, brick in combination with titanium, metal panels or glass buildings such as the Erasmus Pavilion right in the heart of Campus.

In contrast to the grey and brown shades predominant in Erasmus Campus, the main colours of the Brainpark I area are white in combination with different shades of blue from the different types of glass present in the offices buildings. Different proportions of white concrete and glass are the dominant choice for this building's typology. There are also several private buildings using only glass as the main material.

It is also important to look at the choice of pavement materials in the area, since they also contribute to generate the ambience in each site:

In the campus, the main surface is the pedestrian area, using bright beige granite cobblestones. In Brainpark I, there is a strong contrast between the big green surface containing a lake in the heart of the business park, and the important presence of car parking sites of granite cobblestone (different from the Campus) surrounding every building, generating the perimeter of this green space and completely changing the atmosphere of the business area.

There is also an important presence of asphalt in all the roads that generate the perimeter of this location.

CAMPUS MATERIALS

Glass
Aluminium slats



Concrete
(grey)

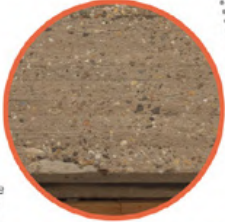

Concrete
(brown)

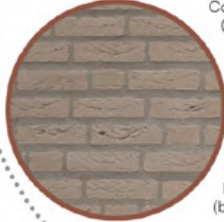

Brick
(brown)



Folded
Aluminium sheet



Terrazzo



Titanium
(grey-brown)

BRAINPARK MATERIALS



Granite
(white)



Glass



Glass +
Concrete



Metal panel
(white)



Brick
(white)

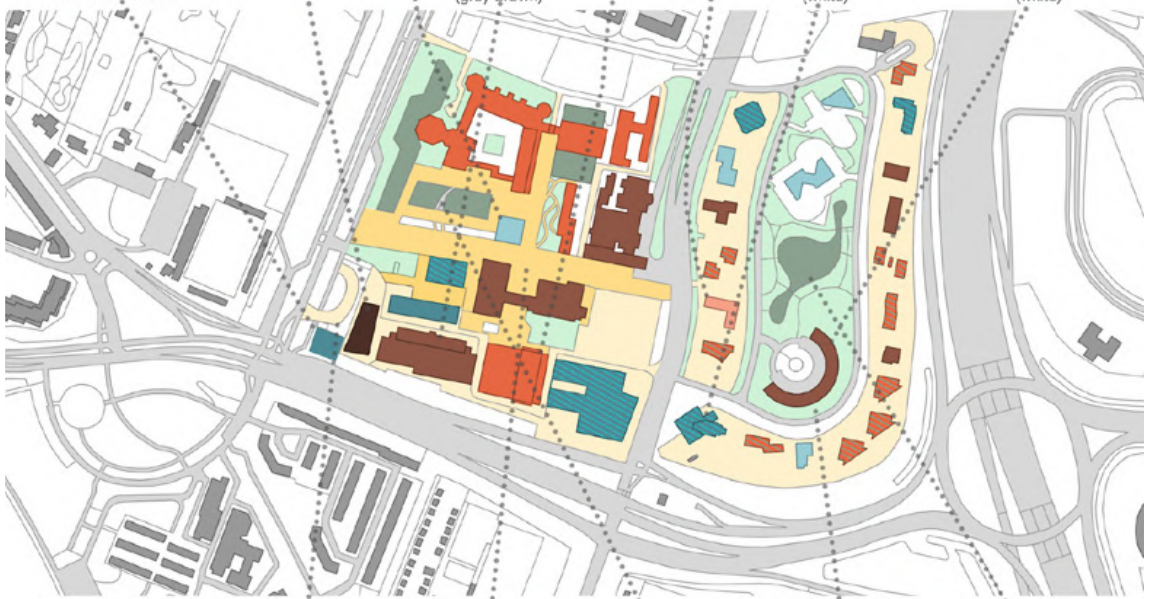

PAVEMENTS



Asphalt



Granite
cobblestone
(grey)



Granite
cobblestone
(beige)



Steel grid



Natural
soil

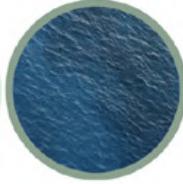

Water



Rings

Erasmus Station
Centrifugal!

Coen Jager
I-Hsuan Lee
Sofia Pavlova
Birte Zacharias

Introduction

The New Erasmus Metro Station

What is the future of Rotterdam? With the ring line planned for 2050, how are we going to push this city a step forward? How do we want to form its future?

For the development of the new ring line in Rotterdam, we took the history of the metropolitan city of Tokyo as our reference and went through the city plan. We supposed the ring line in Rotterdam is meant to be built in order to balance the development of different areas inside the city. Moreover, it will stabilise the land value so that the market of real estate will stay steady. According to our initial research, this area is isolated by different parts such as the university, the business area and the main infrastructure nodes. This in combination with the mono-functional areas and homogeneous user groups seems to be our biggest challenge. As the station is not planned to be a big infrastructure node that provides interconnection with other lines, the overall aim and function of the new station gain even more importance. By proposing an interesting design, we have the opportunity to address another issue related to the usage of the station during the day. Currently, the public transportation in the area is mainly used in rush hours between 7:30 - 10:00 in the morning and 16:00 - 18:30 in the evening.

Deriving from the findings of our research, our group came to a concept that connects the four isolated islands in the area and promotes a more sustainable city in the future. We chose the crossing point of the main roads as our location for the above mentioned reasons concerning connection but also because it is the middle point between De Esch and Kralingse Zoom. Although the southern part of our site is still quite desolated, it has a potential to densify with housing in the future. Additionally, further south there already are plans for densifying the area with more residency buildings. We would like to focus on the bigger picture, in particular, the future and the potential of the city, rather than concentrating only on the current situation of the university and the business area.

Starting from our station, Erasmus, in the ring line, we planned to densify the area, eliminate the boundaries among the four isolated parts, reorganise the traffic system, and promote the walking city concept. Firstly, we plan to push the carbon dioxide belt outside of the city centre by establishing a bus station next to the exit of the highway. The metro is planned to be built underneath the bus station so that the passengers could get out of the highway and take the metro to go to the city centre. This could not only avoid several traffic jams

inside the city but also reduce the carbon dioxide in the city centre. Secondly, we plan to connect the old main road parallel to the highway with our metro station with the idea of a car free pavement. By removing the vehicles between the business area and the university, we eliminate the physical boundary in between. Thirdly, with the two exits at both the northern part and the southern part of the station, we link the area of future housing not only with the current university and business area, but also with the rest of the city centre. The last part of our design is to make this metro stop itself a point of attraction so people would go there, meet each other and connect.

For the design itself, the idea is to find a relationship to its surroundings. There are several buildings and pathways in organic shapes that can be transformed into the design of this metro station. The only visible part of the Erasmus metro station on this site above ground would be the bridge, which is why its form will be adapted to those organic forms in the surrounding area. In order to find a connection within the station, this form will reflect underground in a certain way. This will strengthen not only the horizontal connection of the four areas, but also the vertical connection within the station.

With the densifying plan of future Rotterdam and our proposal for Erasmus, the metro stations within walking distance will become an attractive node in the future.



Rotterdam - The New Tokyo
Collage

Erasmus Station

Cylinders

The station can be accessed by four entrances in total. Two of them, or the so-called fast route, are at both beginnings of the bridge towards Brainpark and Erasmus Campus on one side and the future residential area on the other side.

The two other entrances are through the glazed cylinders on the bridge. They are slow routes that connect the functions through all levels. Those routes will be mainly used by attractors on the bridge who want to make use of all features the station provides. Both cylinders have the same function and form as they are mirrored by the middle axe. However, the first cylinder connects the exit of the bicycle parking while the second one connects to the public amphitheatre. The biggest difference between the circles and the main necessity for both of them is that they address different directions of the main road under the Olympic bridge, namely towards the city centre or outskirts. In this way, the cylinders allow a vertical connection on both sides of the road. The cylinders become a distribution point for the cyclist who parked their bicycles in the circle next to and for passengers coming by bus, moped or car. From this collective point, they all can decide to go upwards to the bridge and the surrounding area, to go down to take the metro line or simply to cross the infrastructure node.

The materials and forms of the cylinders aim to follow the overall expression of the station. They combine curved shape, transparency, and flexibility. The entrance of the cylinders is uplifted from the bridge. It is held by elegant columns and a flat green roof with a glazed opening in the middle to allow natural light to penetrate in the station. The design of the cylinders merged in the surrounding yet still well recognized as an entrance. The transparent glass façades on Level 0 and -1 allow protecting the cylinders from rain and wind as well as from vandalism during the night. This is possible by the rotating glass doors by the entrances on Level 0, by the bus stop, and car park on Level -1.

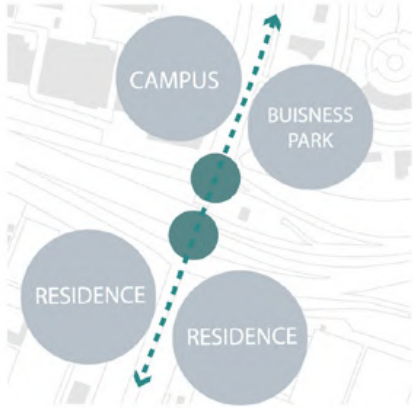

GOALS

1. Connection of the Existing Zones

Connection diagram



2. Penetration of natural light in the station

Sun direction diagram

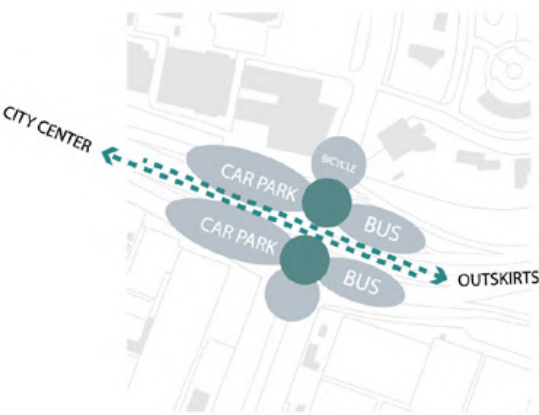

3. Connection of various vehicles: mobility hub

Mobility hub diagram

Initial Ideas

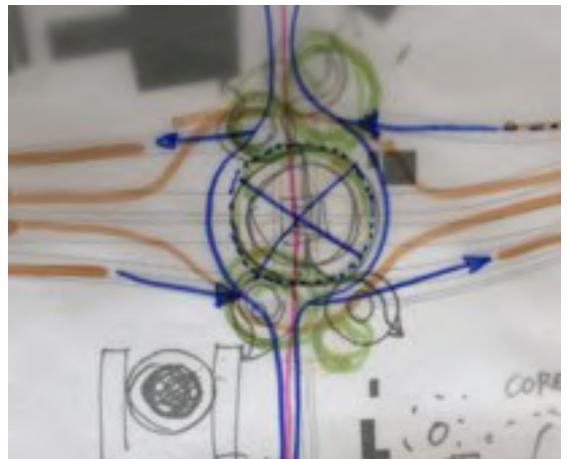
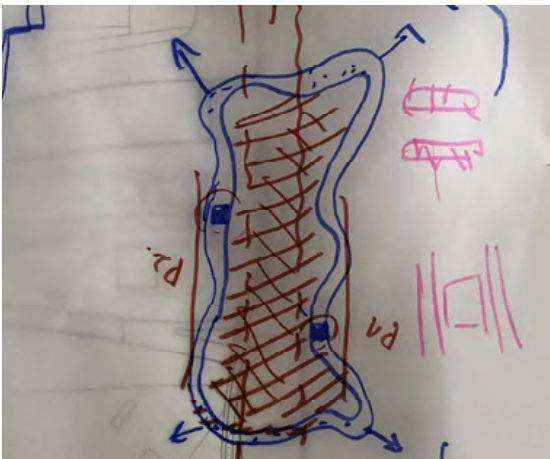
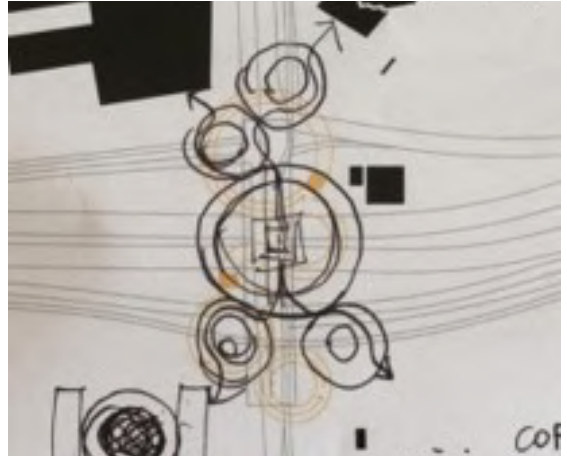
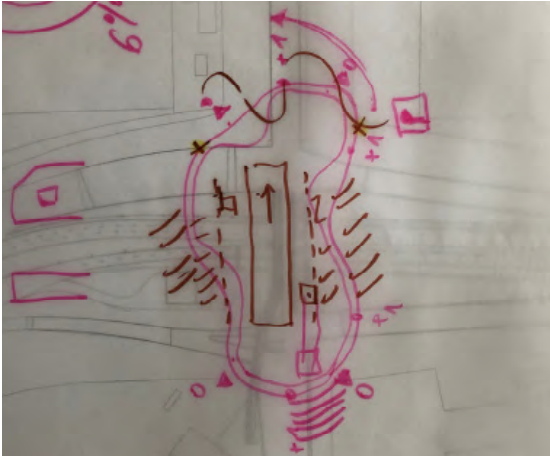

First idea
Connection by a pathway that connects all four sides

Second idea
More defined connecting pathway

Third idea
Five rings with major changes of the current traffic situation

Fourth idea
Definition of the interconnection

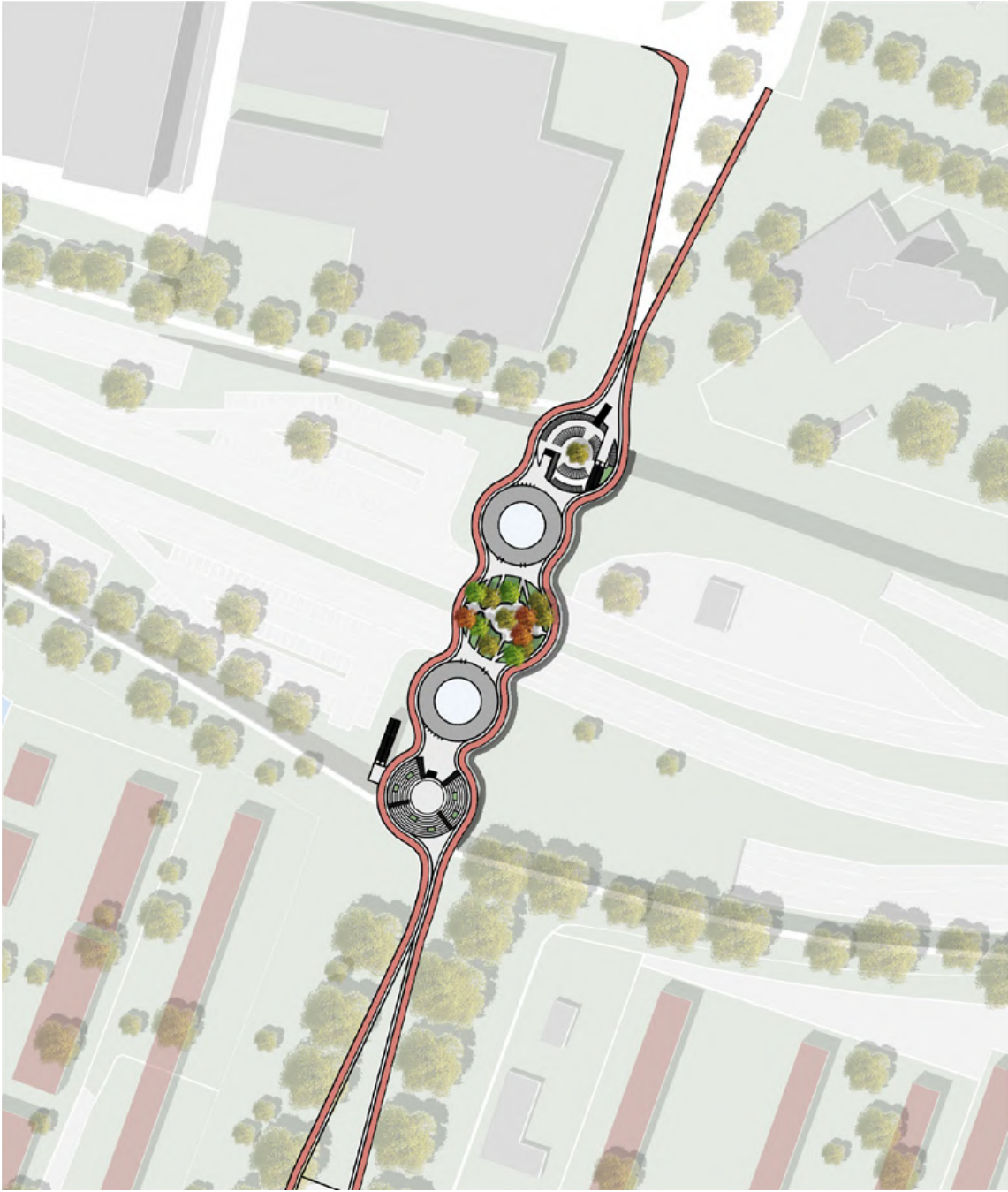

Masterplan

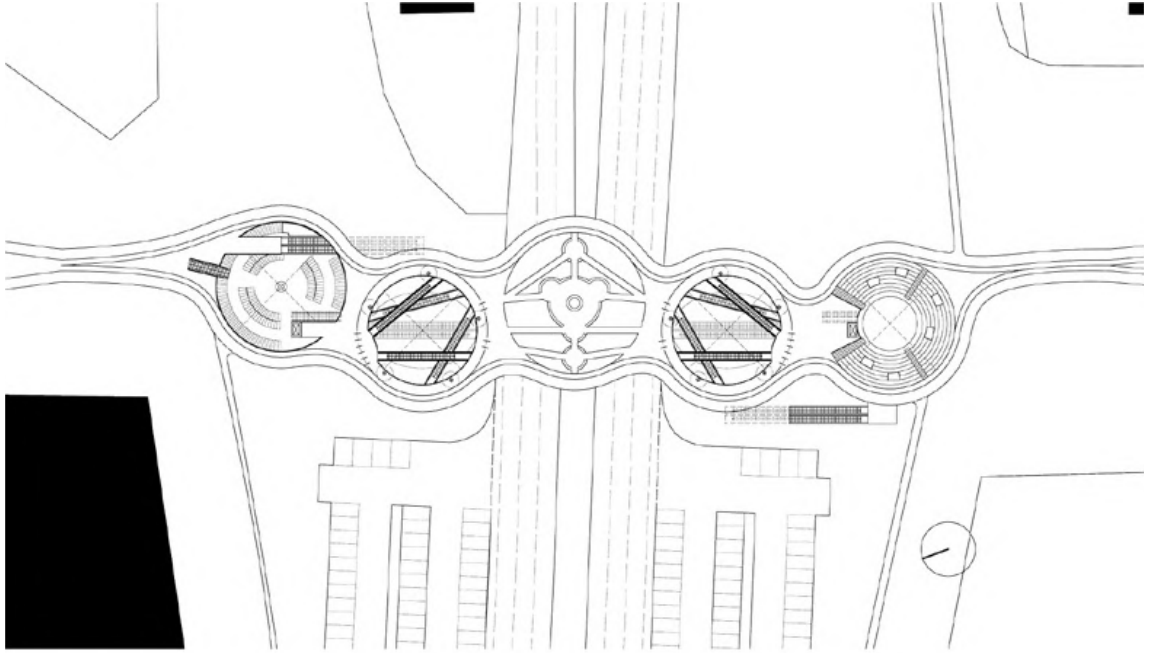

Level 0. Bridge
Floor Plan

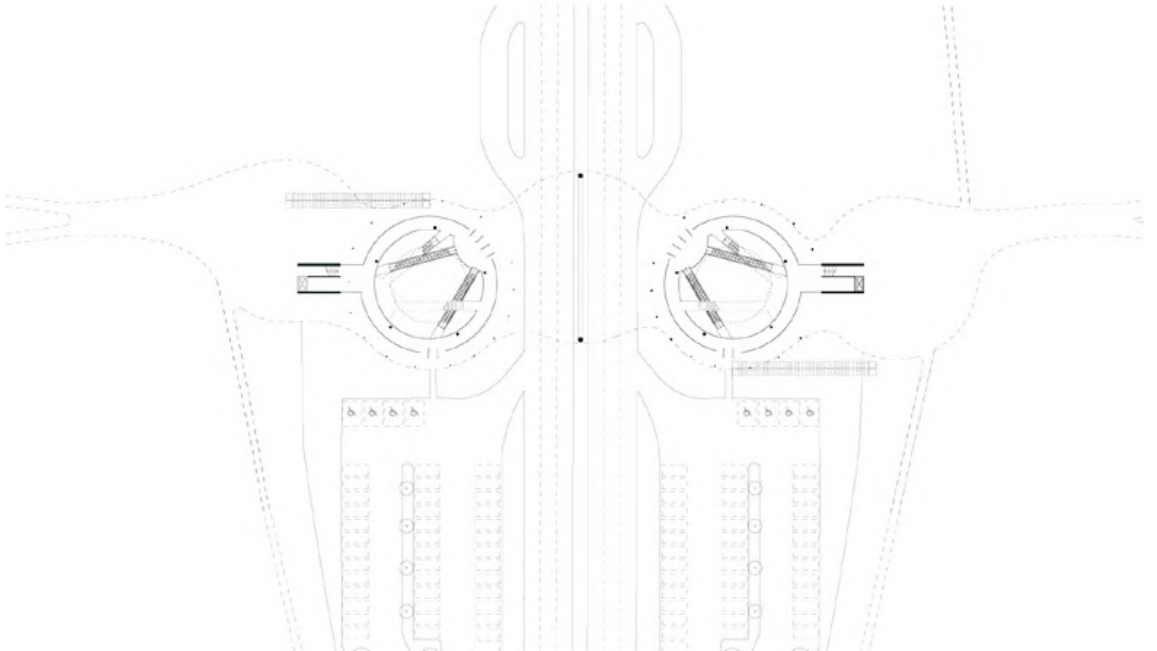

Level -1. Bus stop
Floor Plan

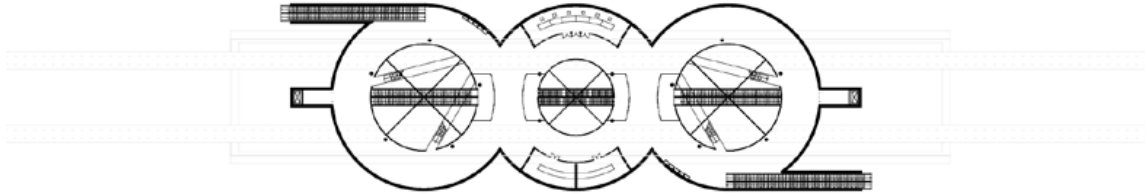

Level -2. Concourse
Floor Plan

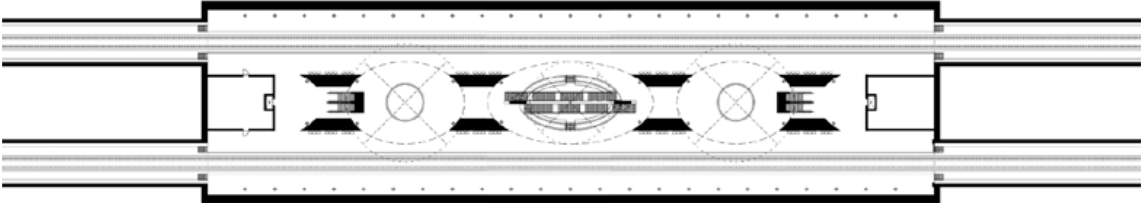

Level -3. Metro platform
Floor Plan

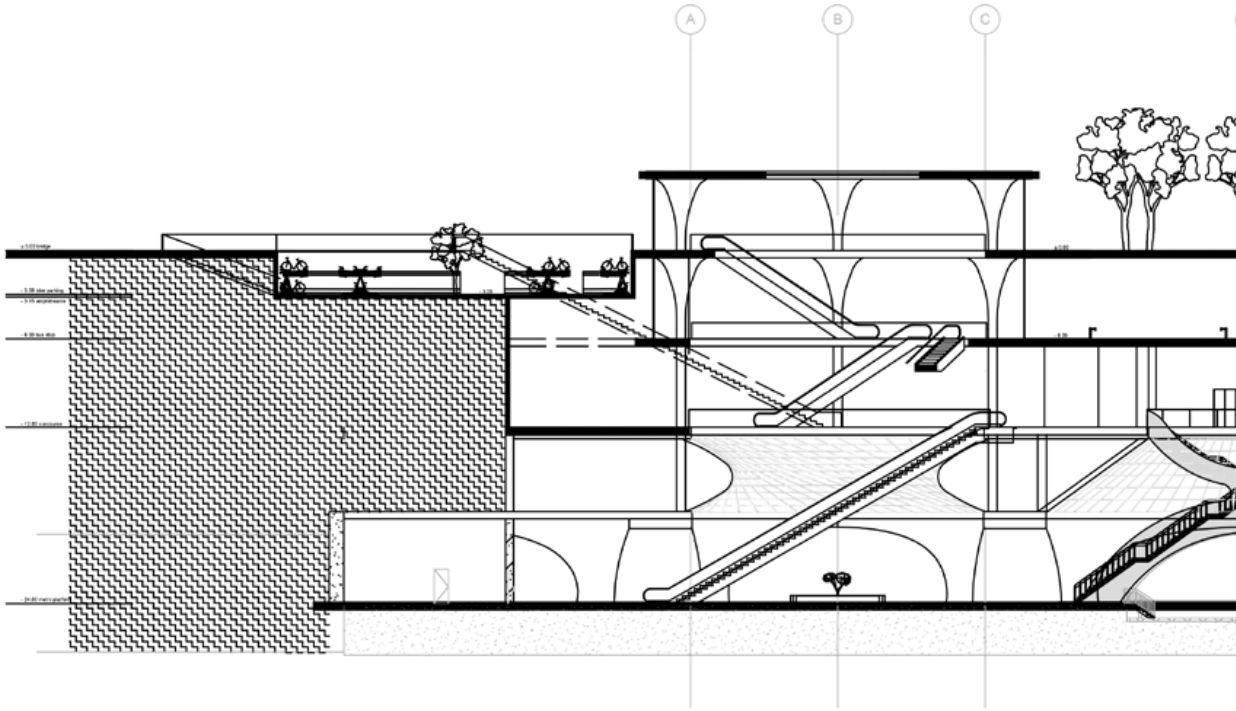

Longitudinal section A-A
Section

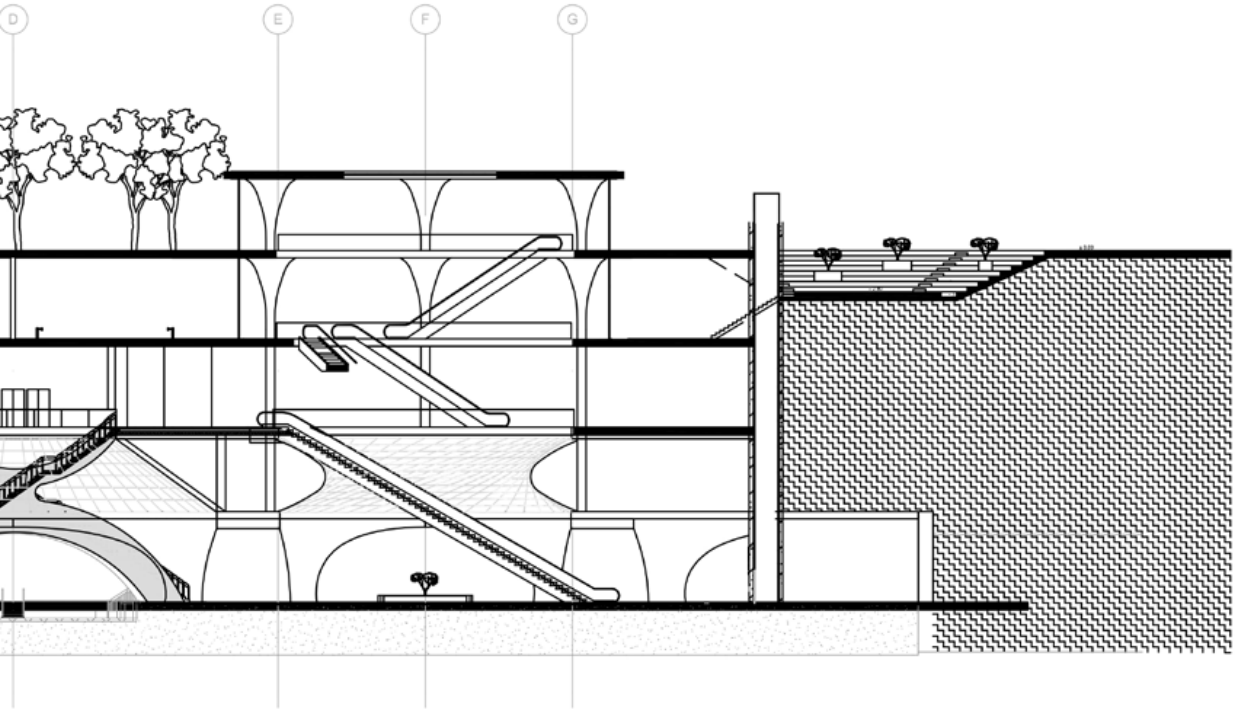



Level 0. Bridge side view
Illustration



Level 0. Bridge overview
Illustration

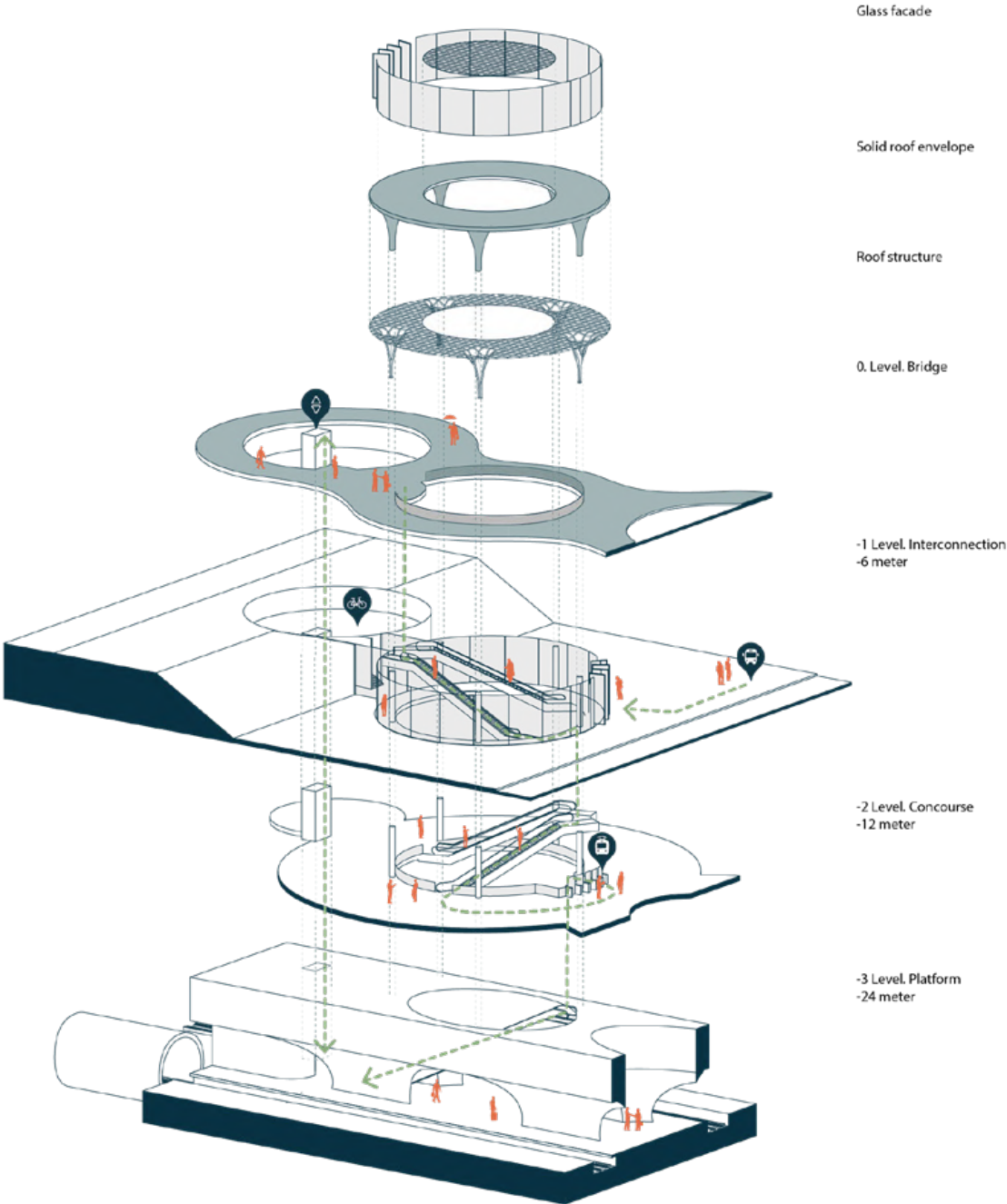

Exploded axonometric with circulation

Circulation

Circulation Strategy

The below diagram shows the potential routes of passengers as soon as they arrive the concourse. Different directions of routes are designed based on the decisions the passengers made. Starting from the question every passenger has when entering the concourse - "do I need to buy a ticket?" It leads to the concept of guiding passengers with spatial quality to certain destinations according to the individual needs.

Crowd Control

Thinking about the future population in this area and the densification plan of Rotterdam, it is evaluated that the circulation should have the function of redirecting the passengers in the station in order to soothe the jammed crowd in the rush hour. The strategy of redirecting the flow includes dividing more paths from one, offering the choice of going either to left or right to the destination so that people could walk more, thus, avoiding the jammed situation.

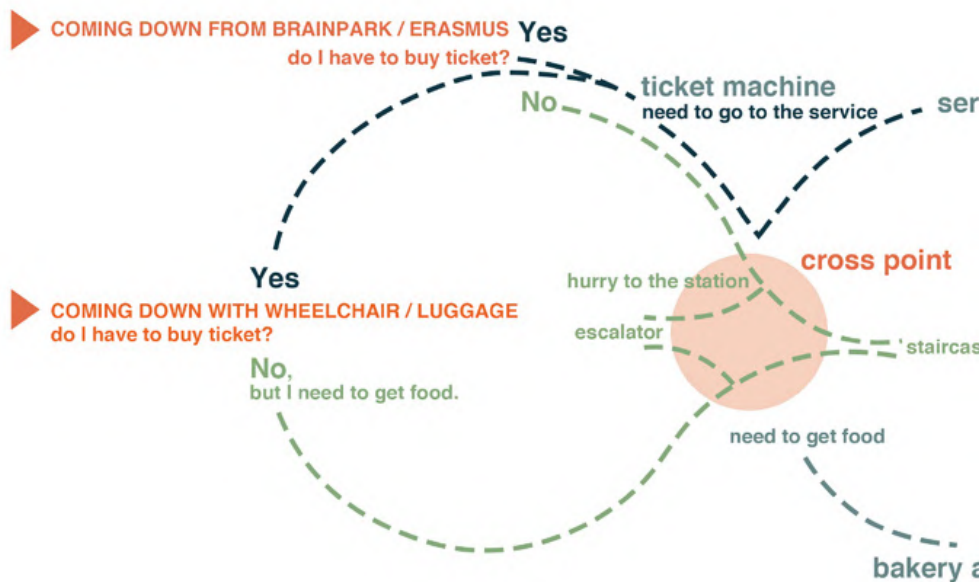

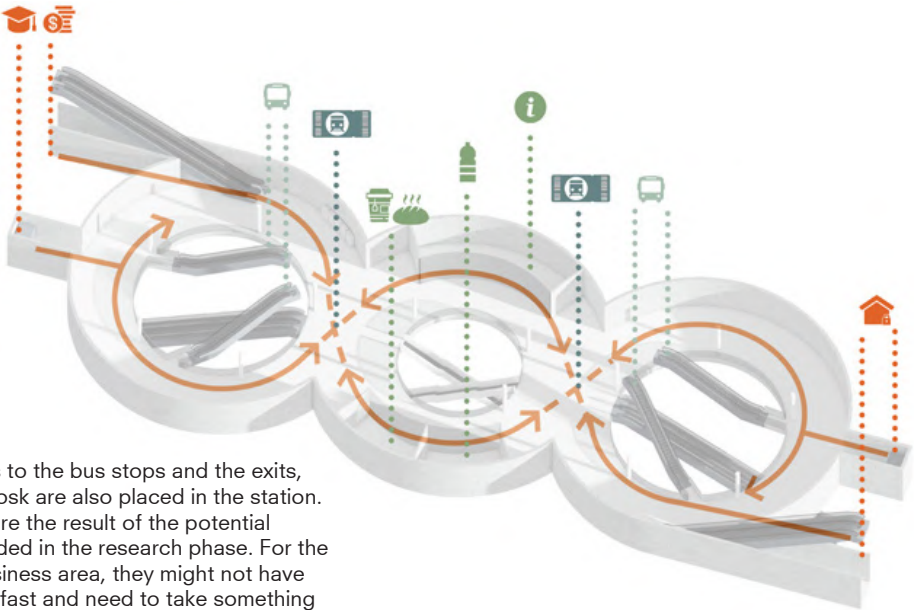

Facilities

Apart from the access to the bus stops and the exits, service, bakery and kiosk are also placed in the station. These extra facilities are the result of the potential population we concluded in the research phase. For the passengers to the business area, they might not have enough time for breakfast and need to take something to-go. Service is planned here for people who want to go into the city centre with the metro after parking their cars next to the highway.

Spatial Guidance

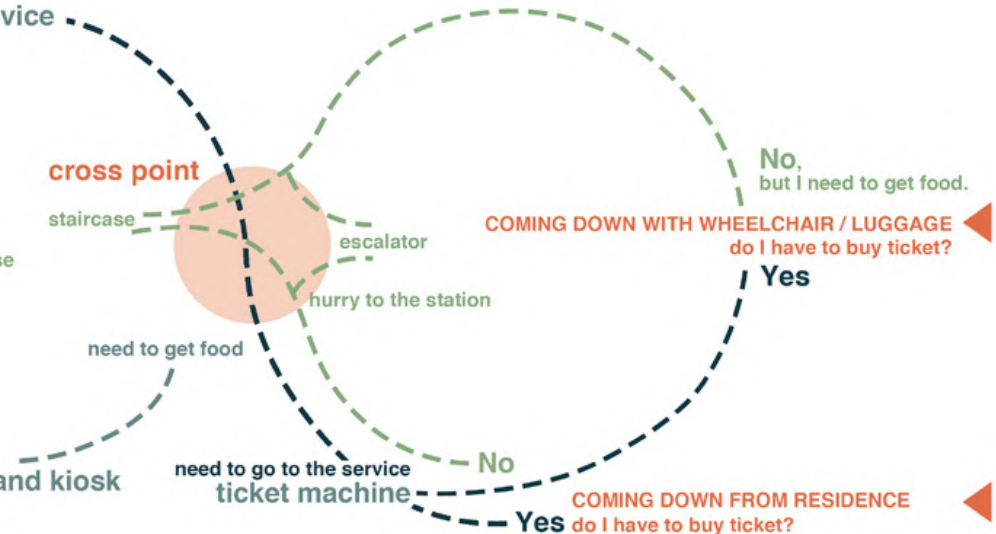

Spatial Guidance

The intention of placing the fast entrances to the concourse there is to make the passengers see the entrances and to be guided to the platform by the space directly. Coming out from the escalator, passengers see the cylinders with the entrances and exits going up and down immediately, making it easy for them to find the ways to their destination.

Coming down with the elevators, passengers will be guided by the space, their sight will be directed by the curved wall along to the cross point. From the first sight they could already choose to go either left or right down to take the metro, saving the time from finding the right route to go down.

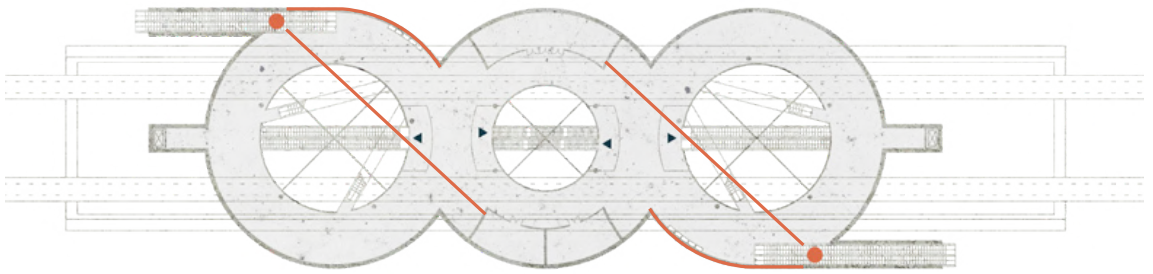

View from escalator
Illustration

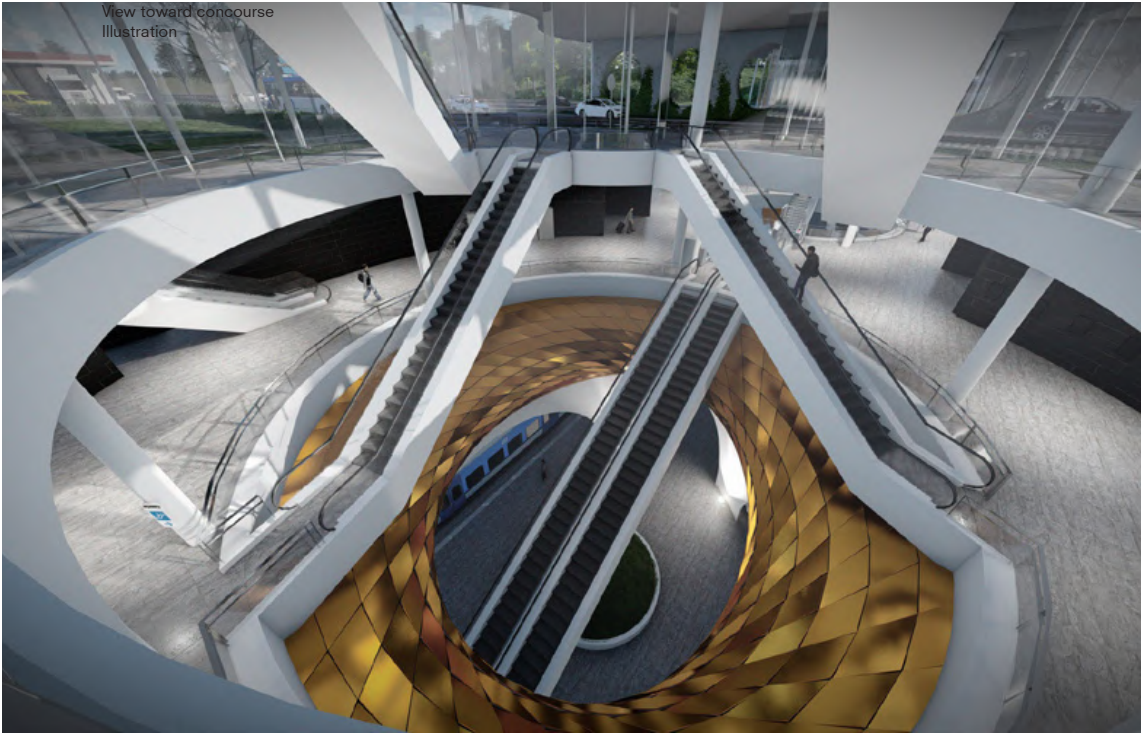
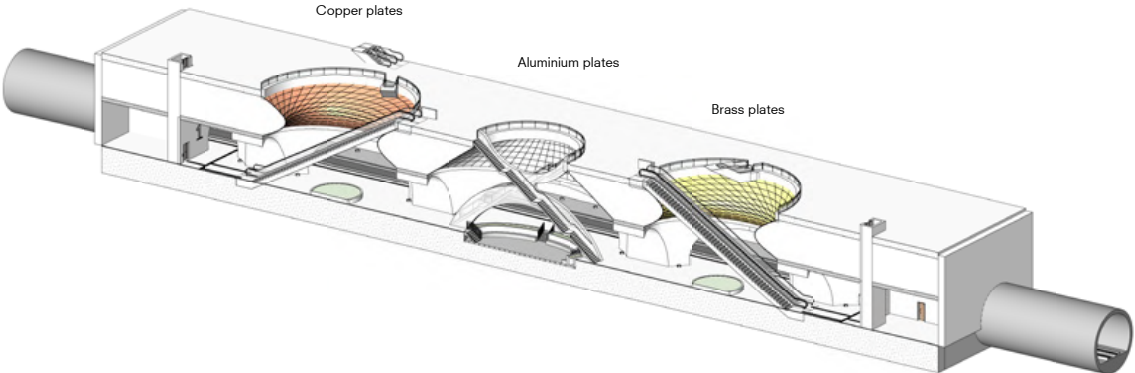

View toward concourse
Illustration

Metro Platform

Concept

The metro platform is meant as a space which is visually pleasing and interesting to walk around in. To make the waiting time for people less boring and more inspiring. The concept of rings is continued down here as well, three large open spaces create continuity to the outside world as it lets daylight insinuate to the platform. Circular voids in each axis shape the station's construction and architecture.

To create a form of guidance in the station, each opening has its own materiality and colour. The bridge as connecting Olympic rings is put to the next level with its medals, gold, silver and bronze openings. For obvious reasons it must resemble these materials, being brass, aluminium and copper. Its reflective properties will boost the natural light on the platform as well for artificial light in the night.

Other materials like ceramic black tiles on the walls, create a contrast with the white plastered structure and grey natural stone tiles on the floor, which are robust and not slippery. These materials are durable and are classically related to subways.

Underneath the stairs is an oasis of plants, a lowered deck which creates the perception of being in an underground jungle cave, a place to rest and to isolate yourself from the busy life above.

When one enters the escalator through one of the medals, it arrives in a scene of art, contrasts and surprises.

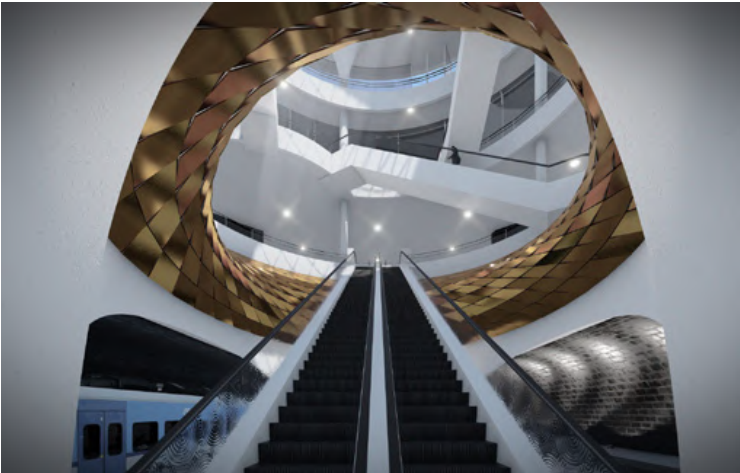

Metro Platform Access Illustration



Metro Platform Illustration

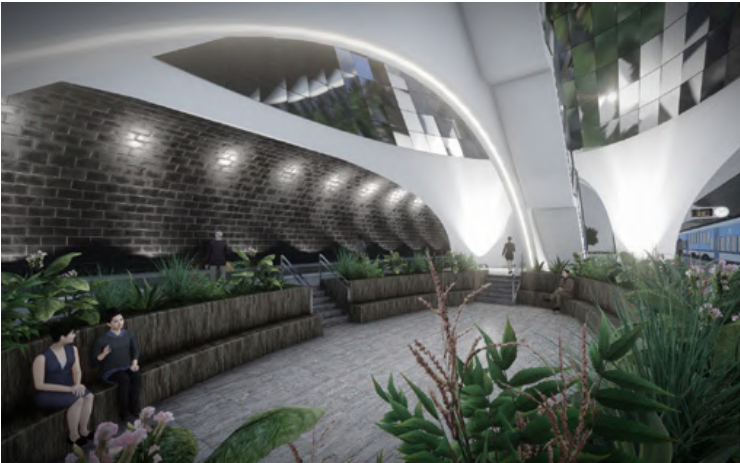

Metro Platform Green Waiting Area Illustration

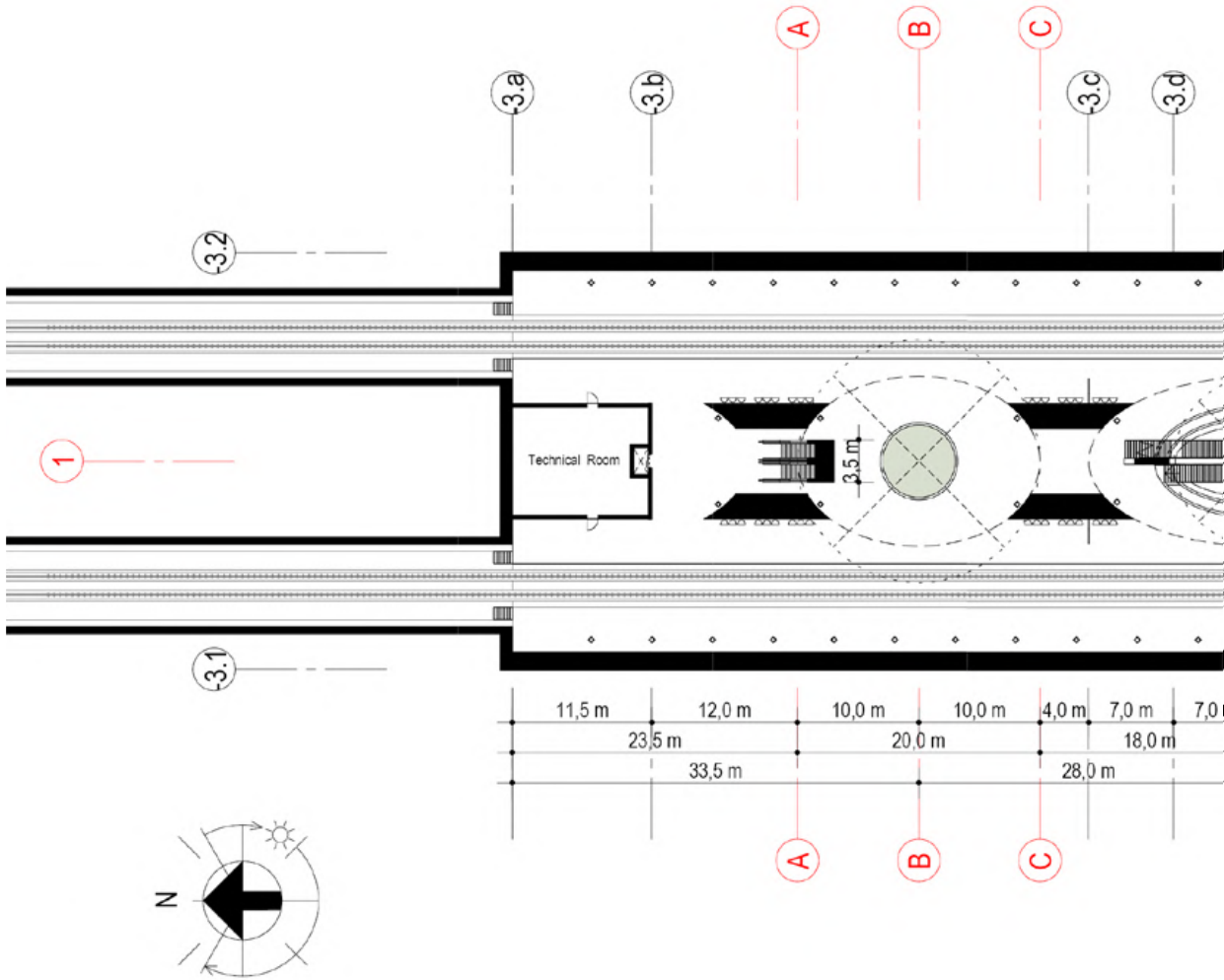

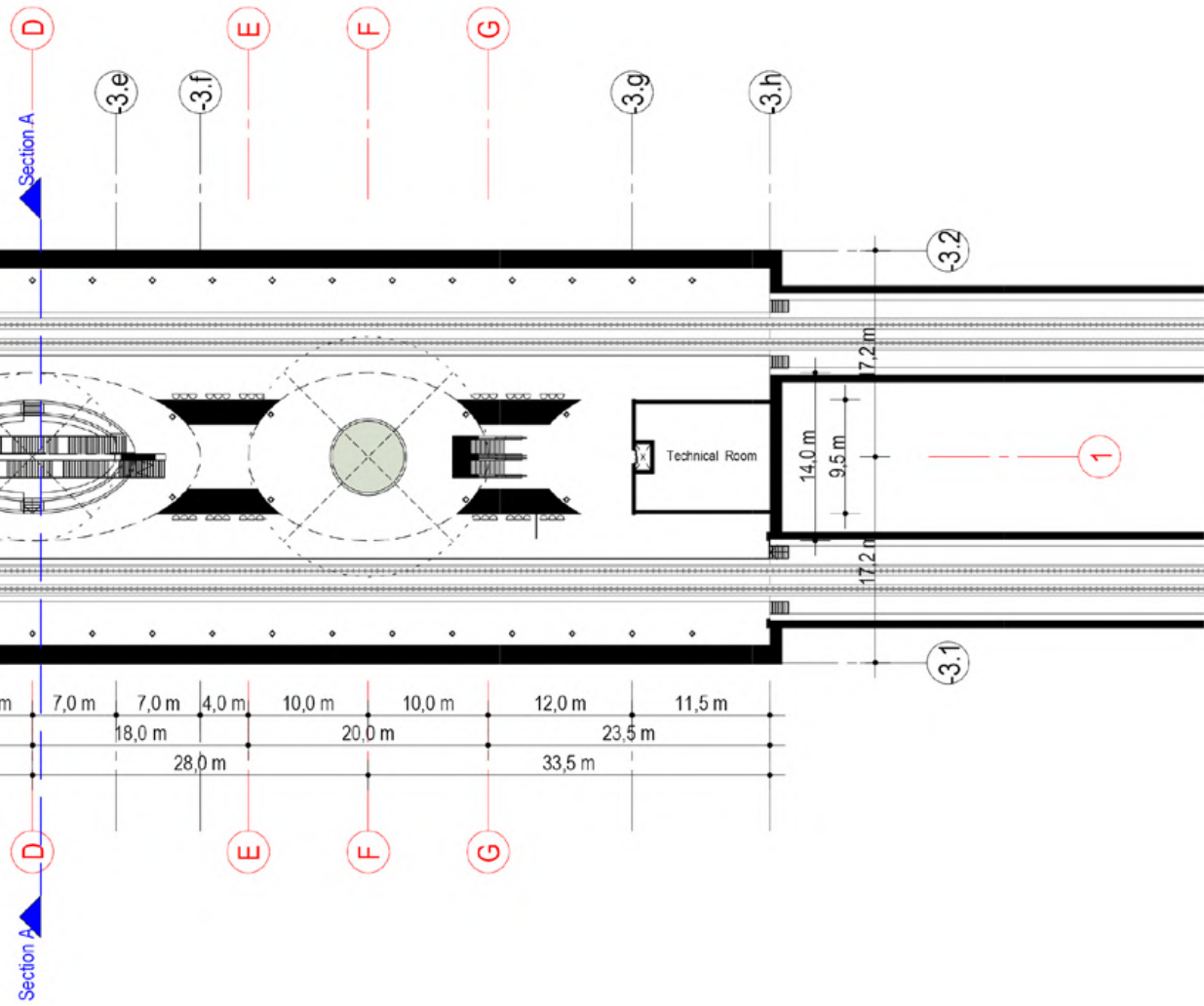

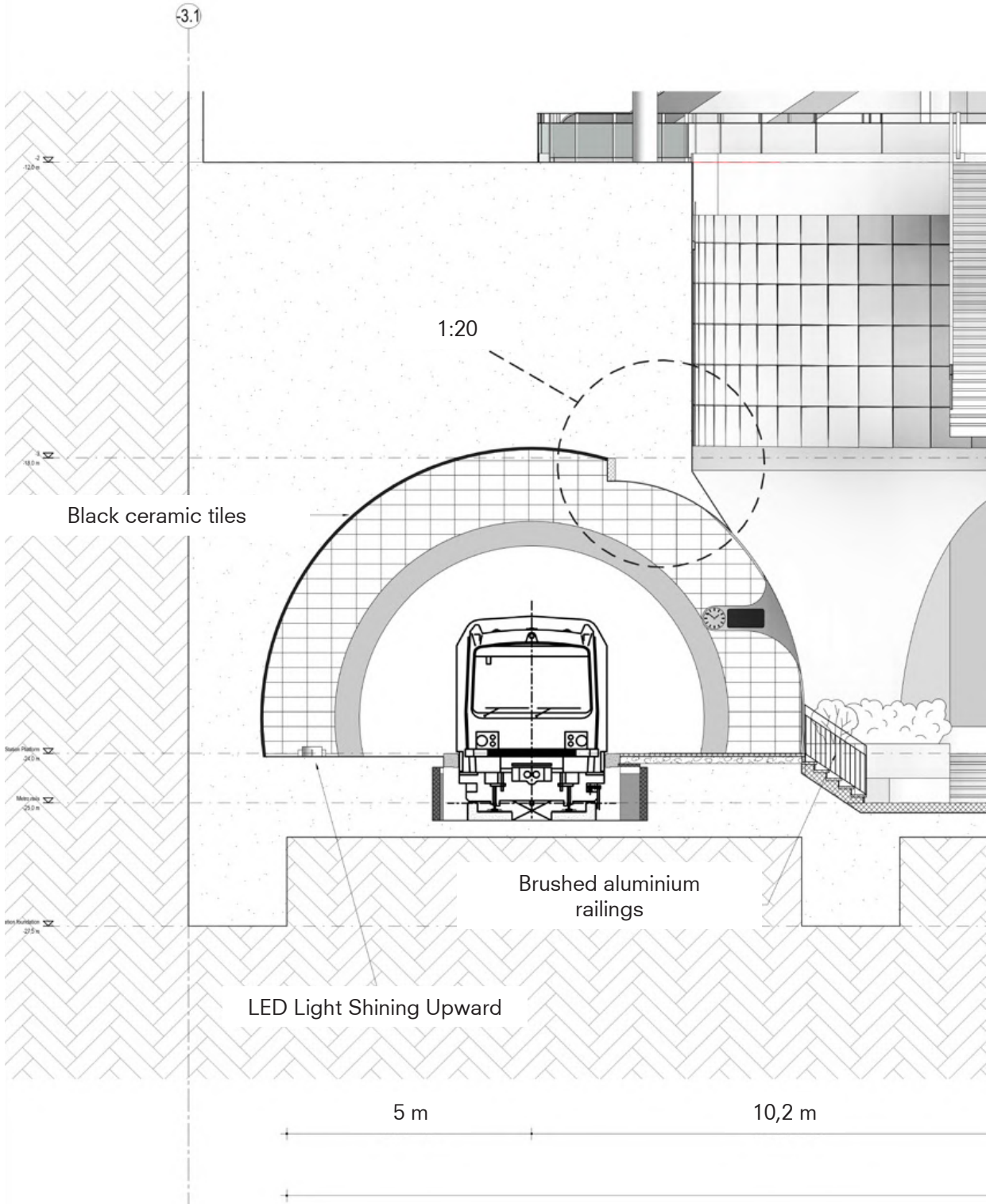

Metro platform cross-section
1:50
Section

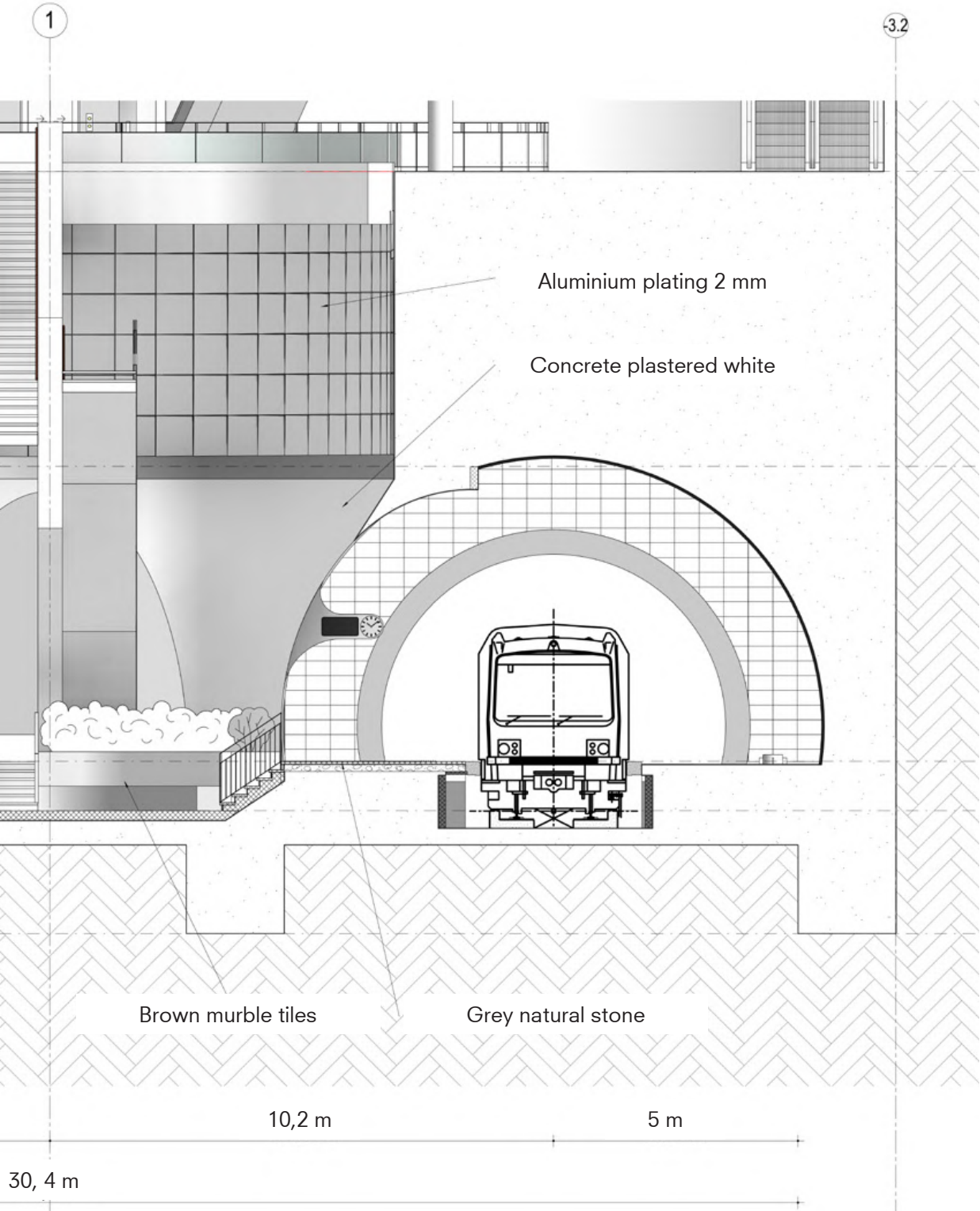



Erasmus Park

Erasmus Station
Centripetal!

Julia Linde
Siddharth Agarwal
Maxwell McGrath

Erasmus Park Concept Summary

In an increasingly digital and overloaded society, there is an increased need to detach and encourage wellness within oneself to mentally 'reset'. The new train station on the border of Erasmus University and the Brain Park will act as a site which connects and unifies both districts while at the same time differentiating itself from its surrounds. The train station will act as a site for health and well-being so that workers and students are able to co-mingle in a setting beyond work. The aim of this is to foster better relationships between students and workers with the potential to encourage cross-collaboration.

While Kralingse Zoom will continue to be the main transport hub in the area, Erasmus Park Station will be the new cultural and wellness hub. Being placed so close to Kralingse Zoom offers Erasmus Park's transportation to be secondary to its actual function. There is less of a focus on transportation and more of a focus on bringing people together. The site will foster a sense of physical connection and wellness through after hour activities and sports.

Universities and business offices require constant work and use of digital mediums which can increase stress and mentally exhaust individuals. The train station's location, adjacent to a large sports complex as well as the functions embedded into the civic area will allow individuals to 'detox' from their day to day work life while encouraging interaction between students and workers. For example, users will use the sports centre for after hours activities then head towards the train station for after sports drinks or relaxation before they take the train from Erasmus Park or Kralingse Zoom. This will offer users a chance to participate in after hours activities which are currently lacking in this zone.

The logic towards encouraging a site focused on well-being and health amongst an area focused on education and business, is to create a place where the mind can wander. People retain new information best when their minds are given time off to encode and consolidate. The train station site and its adjacent functions will create a network of wellness and social settings that foster a place where university students and professionals stay to become creative together before heading off to their homes in the metro station underneath.

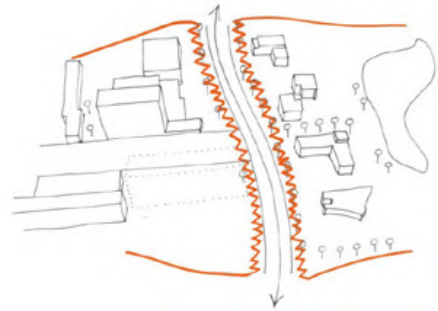

Road acting as a barrier to the precinct

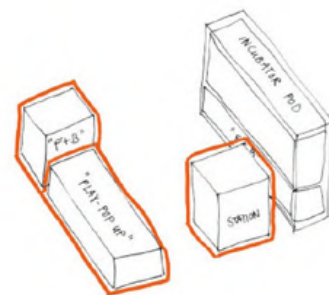
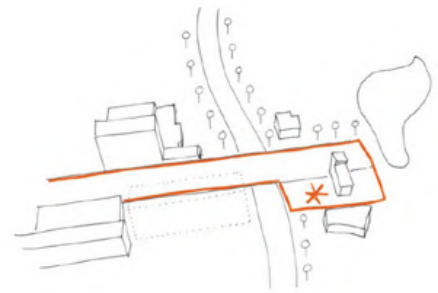

Crossing the road and linking the station into the Erasmus axis

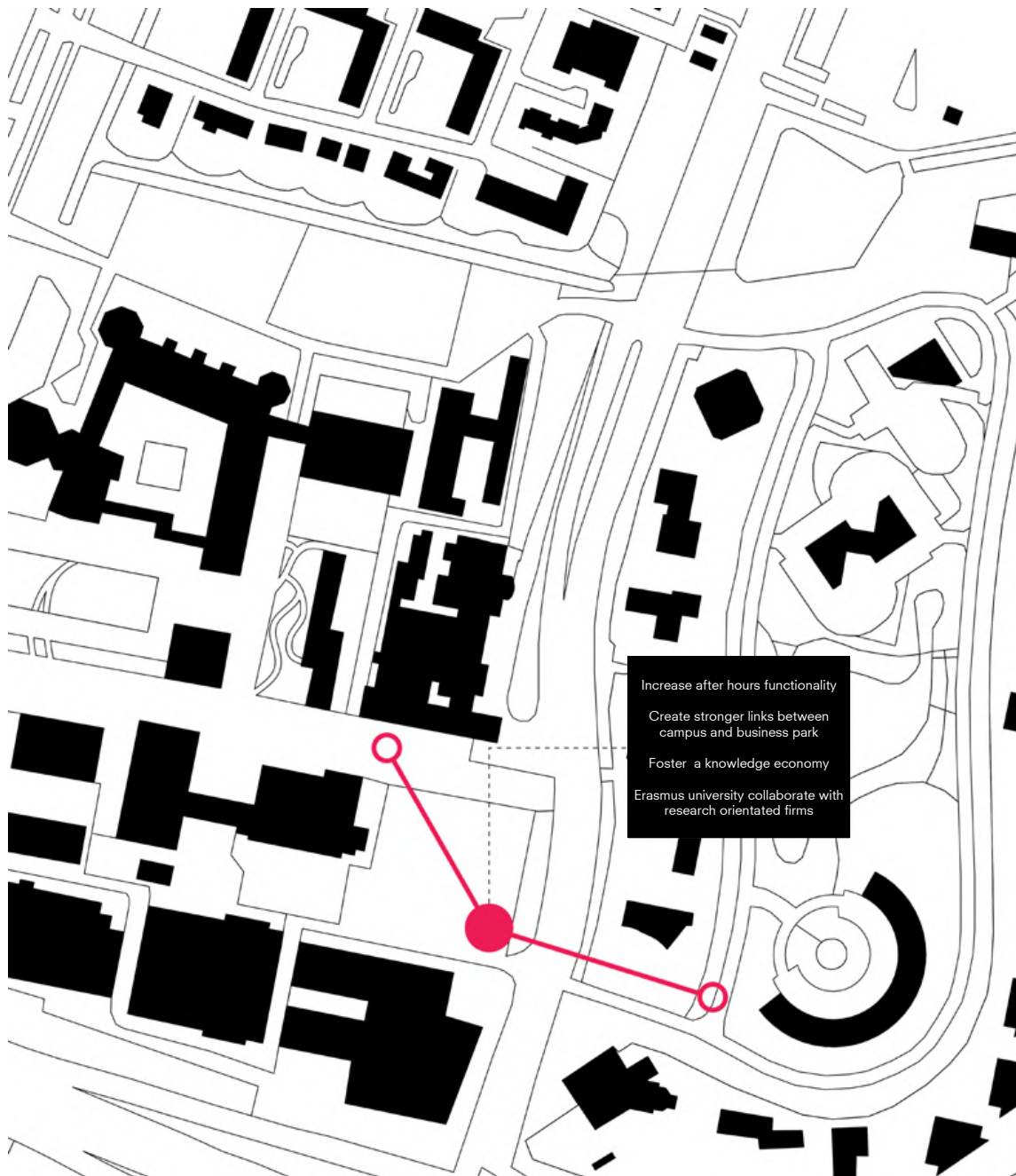

Increase after hours functionality
Create stronger links between campus and business park
Foster a knowledge economy
Erasmus university collaborate with research orientated firms

Concept

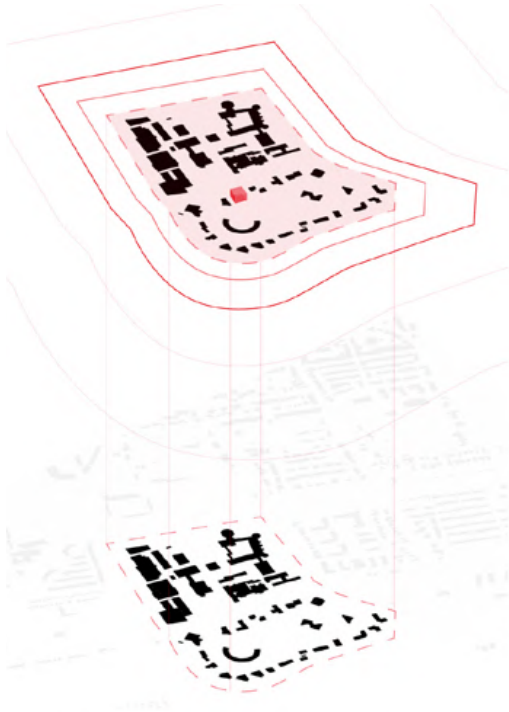

Erasmus park as an island within the city
Station serving only the park



Creating a green heart in the middle of the
Erasmus park



Interaction between two sites



Green heart allows the area to densify

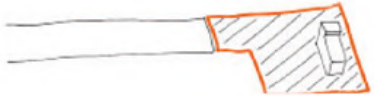
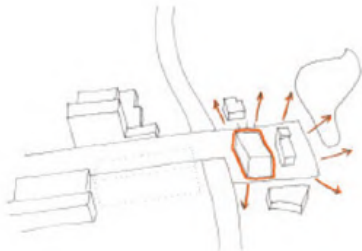
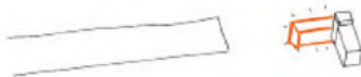
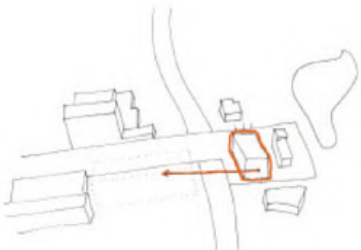
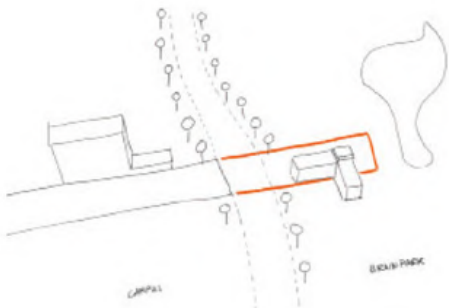
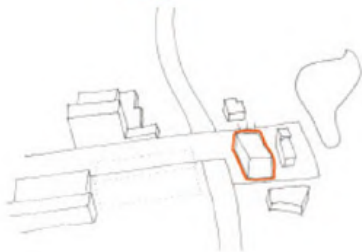

Concept Design Collage

Erasmus Park Masterplan

1. Bike Parking

Bike parking is located on either side of the station.

2. Erasmus Entrance

Erasmus entrance located across the road from the university with direct access to the lower atrium.

3. Overhead Atrium Walkway

An overhead atrium walkway overlooks the square and gives a theatre type quality to the space

4. Lifts to concourse

Lift access from ground level to the square and concourse levels

5. Dome Structure

Dome structure used for rain protection for the square below. Greenery transitions into glass and walkways are used to walk across the dome.

6. Brainpark Entrance

Brainpark entrance located across the road from the university with direct access to the lower atrium.

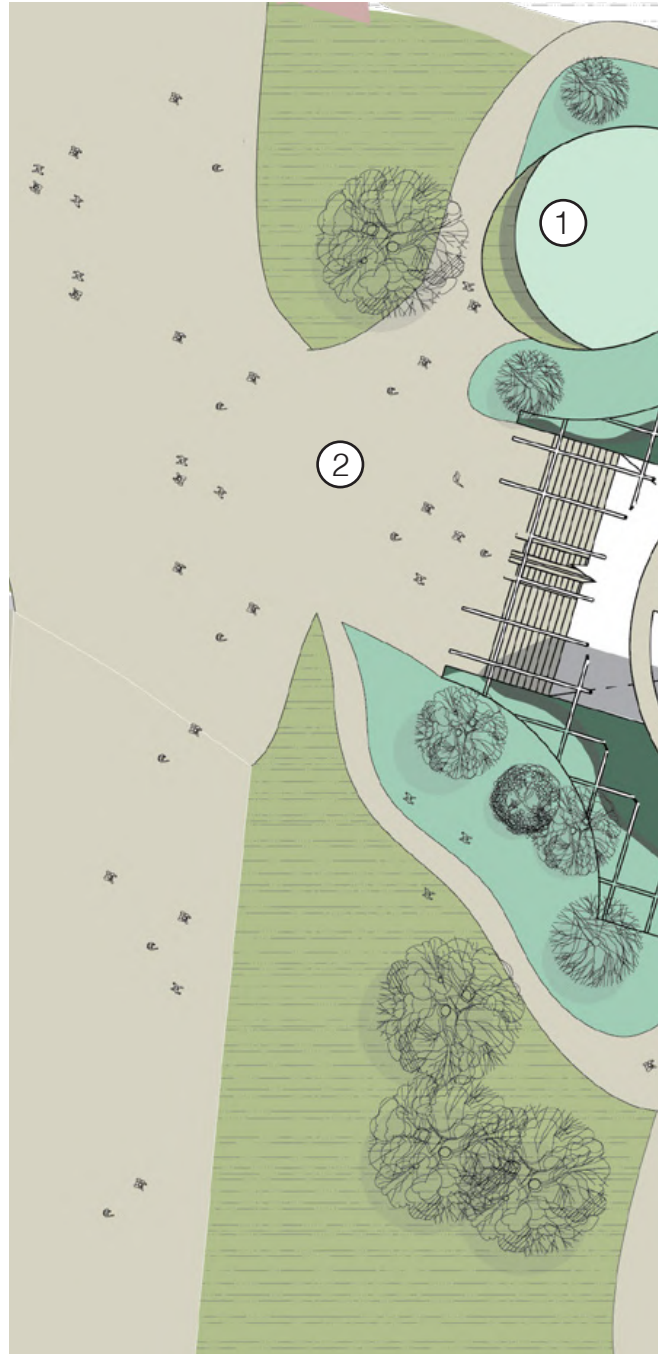

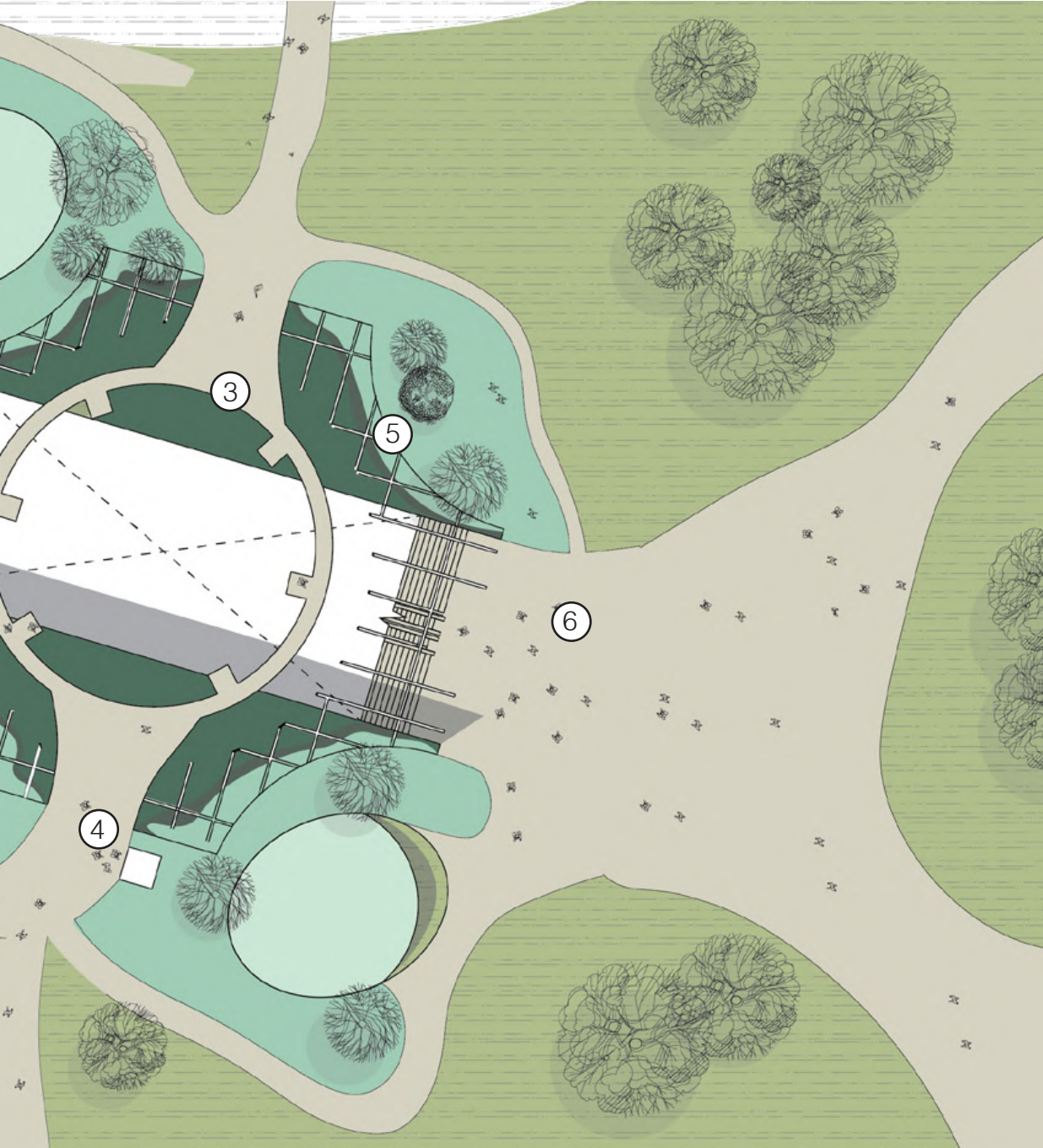

Dome Station Design

The dome to be installed above the station was the individual portion of the assignment taken by myself.

The key goals of the dome was that it made sense with our current concept by being fully integrated into the landscape while acting as a type of beacon for the surrounding area. I set up a series of goals and criteria to be met which were:

- Integrate dome into parkland
- Allow the dome to be accessible to people
- Allow natural light into the square below
- Create a form that welcomes in people from both Brainpark and Erasmus.

These goals were achieved by creating a steel structure that hovers over the square below. From the Erasmus and Brainpark sides, the structural frame 'lifts up' to indicate entrances on either side while a side entrance with a small 'lift' gives access to the internal walkway which acts as a viewing platform for the plaza below. Two walkways run over the dome at its lowest points to create circulation routes over the dome itself. This helps the structure to feel more integrated into the landscape.

The dome is partially covered with plants, with large skylights focused around the pinnacle of the dome to allow sunlight to the lower level. By doing this, the planted zones embeds the dome into the landscape while the skylight areas allows light down and creates a type of beacon for the station.

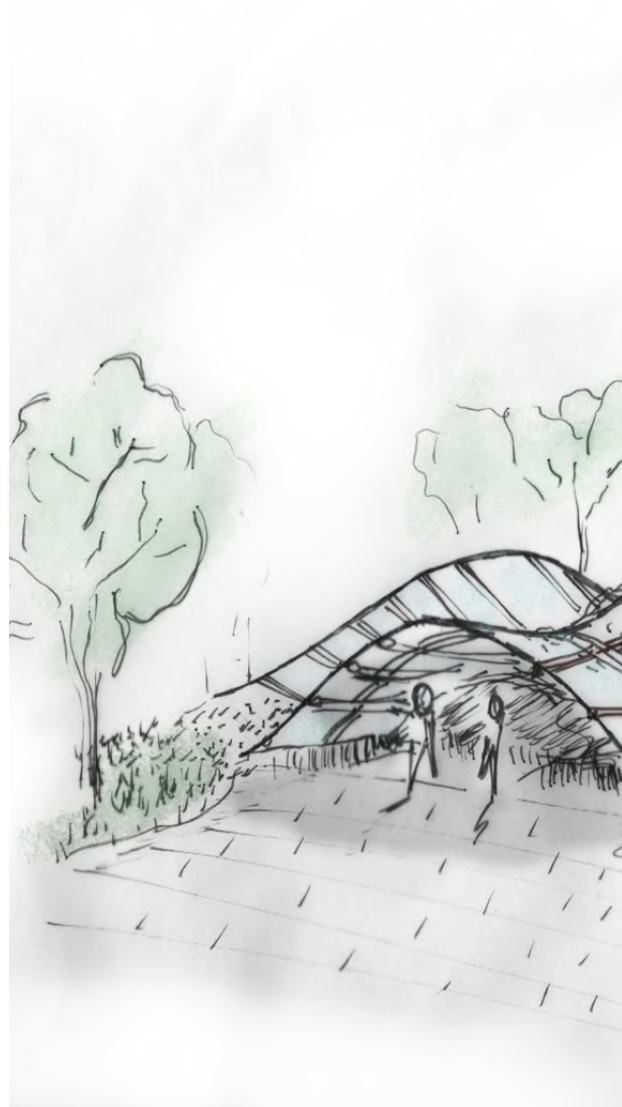



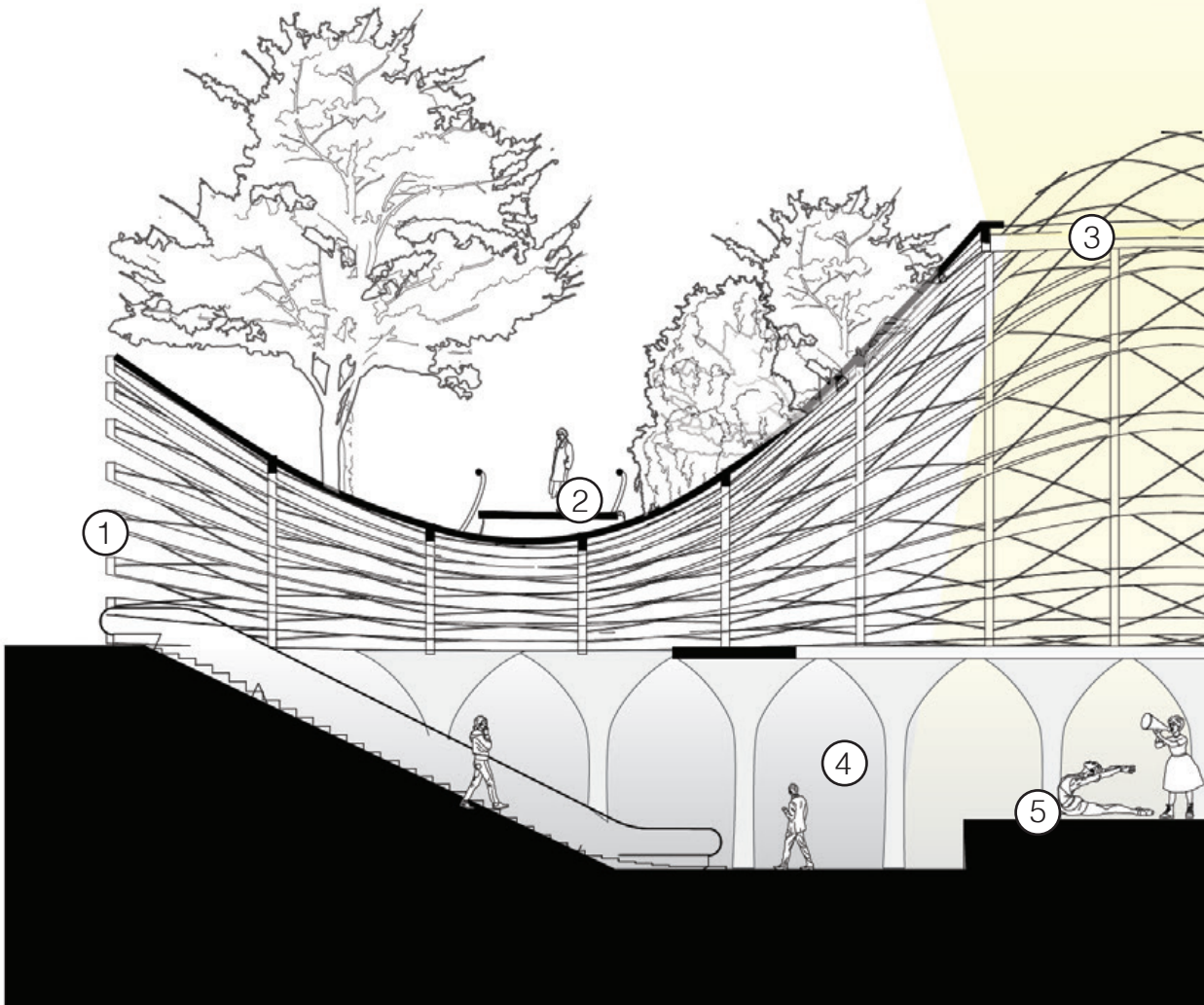

1 Steel Structure

A steel structure is used for the dome to support the glass as well as the fauna that will grow up the structure.

2 Glass

Glass perforations will be used to bring light into the square below

3 Flora + Fauna

Fauna is used to cover parts of the dome and give it a landscaped appeal. This helps the station sit within the landscape and truly embody the site to become the 'green heart' of Erasmus Park precinct

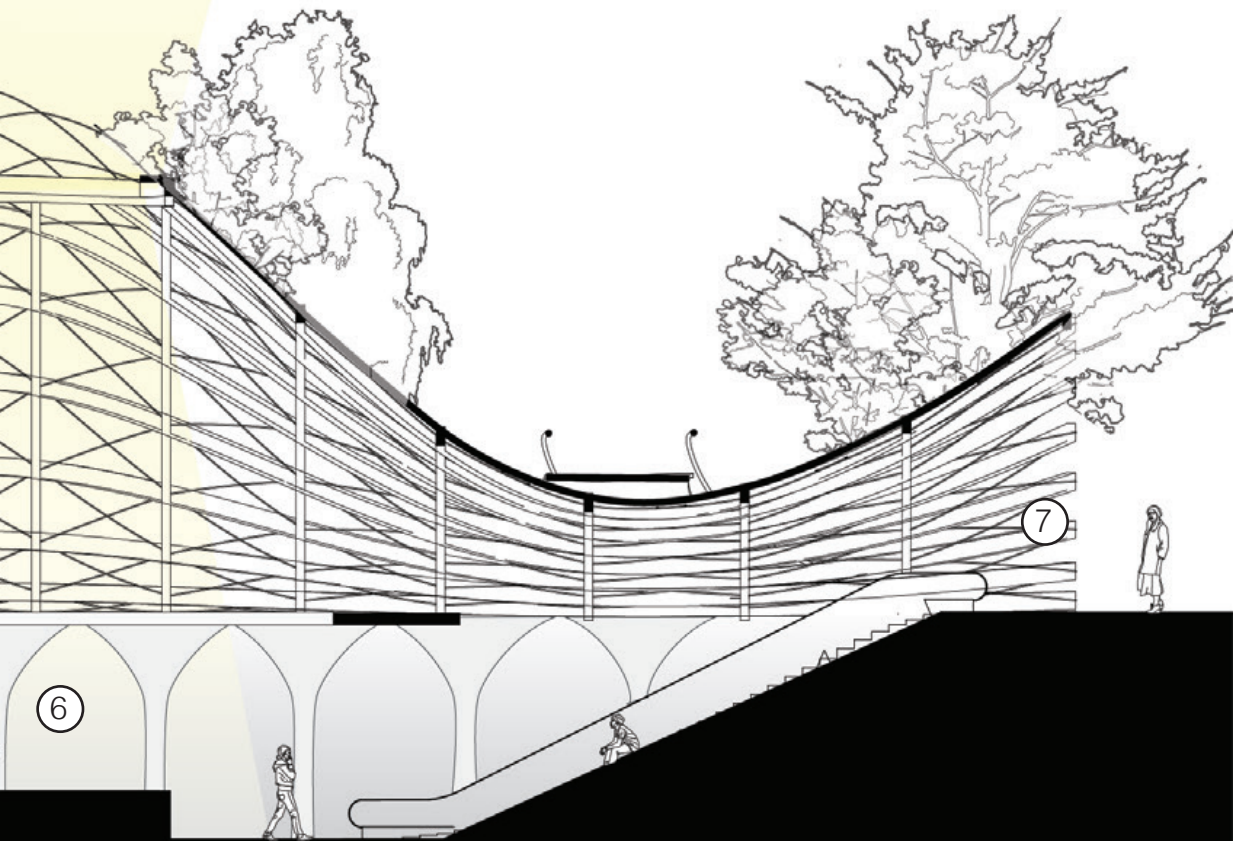

4 Perforated steel walkway

A perforated walkway is used to hover over the dome and require minimal supports onto the dome structure. Plants are able to pass underneath as well

5 Stone Veneer

Stone veneer walls will be used at the entrances of the station so as you sink below ground, you feel the weight of the earth as you progress into the station

6 Pavers

Beige pavers are used to match the material of the main axis in Erasmus University. This provides a material flow into the station

1. Erasmus entrance 2. Over-dome walkway 3. Largest skylight into square 4. Undercroft activity area 5. Main stage 6. Entrance to station concourse 7. Brainpark entrance

Plaza Station Design

The Plaza level (-6 m) contains the main public square and associated facilities.

The building is designed in such a way that it continuously stimulates people to move through from both sides, thus aiming to create a lowered 'boulevard' to bring people together in an informal manner. Through stairs on both sides of the building one enters the public square. This square conveys the link between campus and business park and is where both students and workers gather, interact and use the facilities. Through the oval shape and the organic language, an open but intimate space is created. Different zones on the square facilitate different activities and activate the square as a 5th space. The green and light surrounding make it a comfortable space which connects with the individual and pulls the user to stay and enjoy, for example, a meal.

The main focus of the Plaza is both to facilitate movement of people flows and to actively enable for gathering. The theater-like character of the space enables a feeling of intimacy and people to watch each other and/or host events or exhibitions.

The key goals for the square were to create:

- Intimate green and light space
- Interaction space where people can perform/ gather/host events
- Provide an exclusive unique space for both students and workers
- Square as a 5th space

These goals were activated by several components. The 'earthy' and heavy architecture provides a restful feeling, a place of peace. Because of the serene and calm colouring and robust materials of the square a grounded feeling is activated which will enable the student or worker to unwind after a stressful day.

The green, which seeps in through the roof structure from the park, creates a healthy and liveable environment, a comfortable space.

Finally, by giving a special characteristic to the centre of the square, with a podium and skylights, the middle is activated to be used in multiple ways. The square can host an exhibition, a reading, a music event, anything.

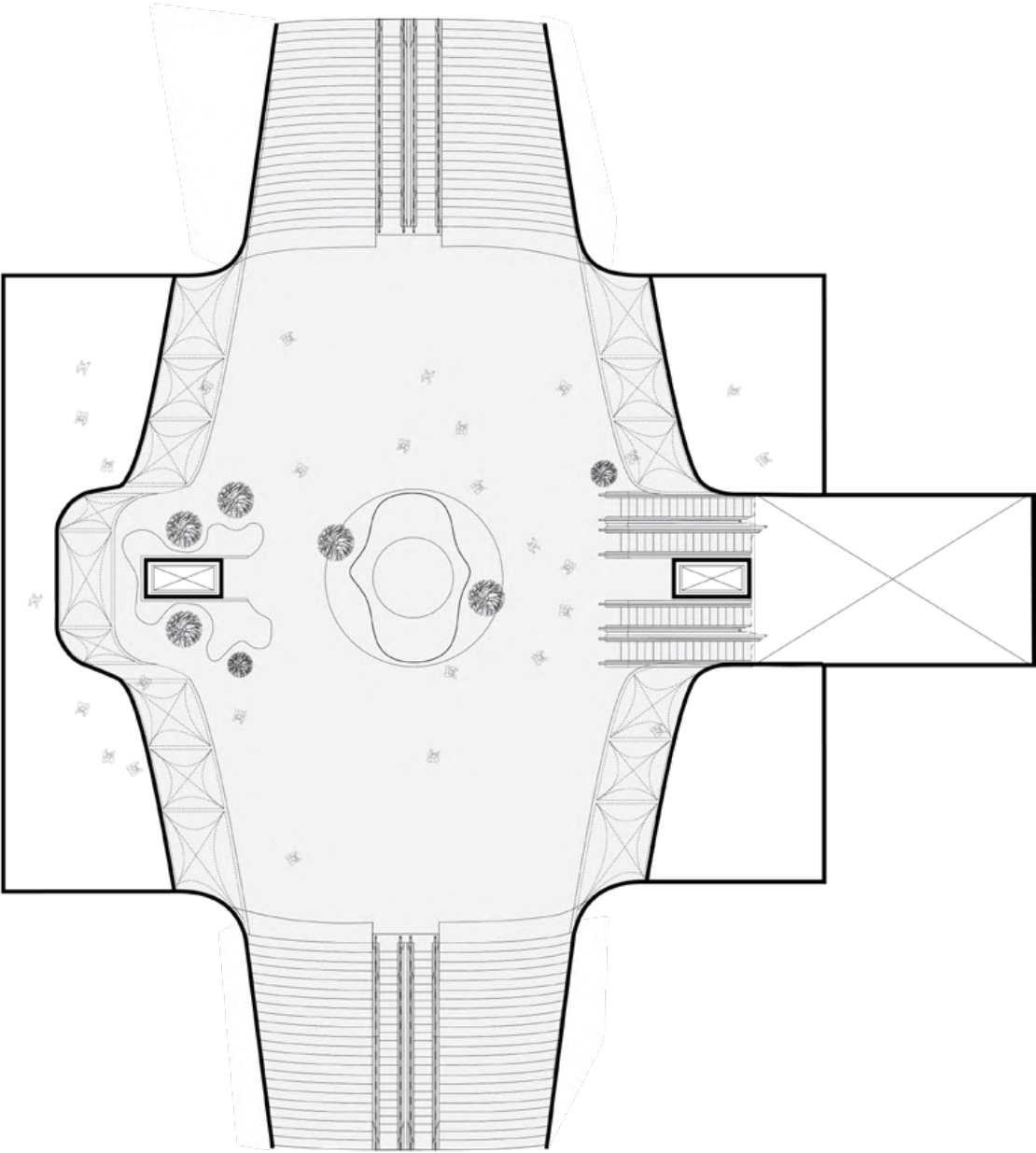

Floor plan Plaza
Level - 6 m

Boundaries and Flow of Space

Plaza

The square is designed to have different boundaries and transitions. The architecture and square design facilitate different forms of interaction.

'Theatre' character

The plaza has an oval shape with large stairs on both sides. The first floor plan shows the intimate 'theatre' that is created. The centre of the square contains a podium with skylights providing light for the concourse platform. The podium doesn't only facilitate a place to sit as well as a place to display things, it can also be used as a podium to host music events etc. Additionally, the object directs the flow of people towards the escalators on the right side of the square; the entrance for the station.

Arches

The arches on both sides of the square provide a soft transition space from the facilities to the public space. The Gothic-like arches create a different ambiance and contrast with the light and open square. It enables people to 'hide' or to watch each other. The feeling of safety is stimulated as well as the feeling of intimacy.

Flow of people

Because of the symmetrical design of the square it is clear where to go if one wants to enter the station. The design aims to create the most efficient flow of people possible. With only escalators going down on one side, a simple entrance is created. There is only one way in or out. The elevators, however, are positioned on both sides of the square to enable bike users and pedestrians to enter from four sides of the building, always the shortest distance.

Daylight

Plaza

In the section (see pg. 254), it is visible how the dome provides light for the entire space. Through circular shapes in the roof, 'spotlight' of daylight come in and light up the square. Through several skylights, light is brought down to the concourse and platform level. The arches are the only spaces that are slightly darker than the rest of the square. However, this only strengthens the feeling of going from an 'earthy' grounded architecture to a light open 'airy' space.



Main Plaza
Illustrations

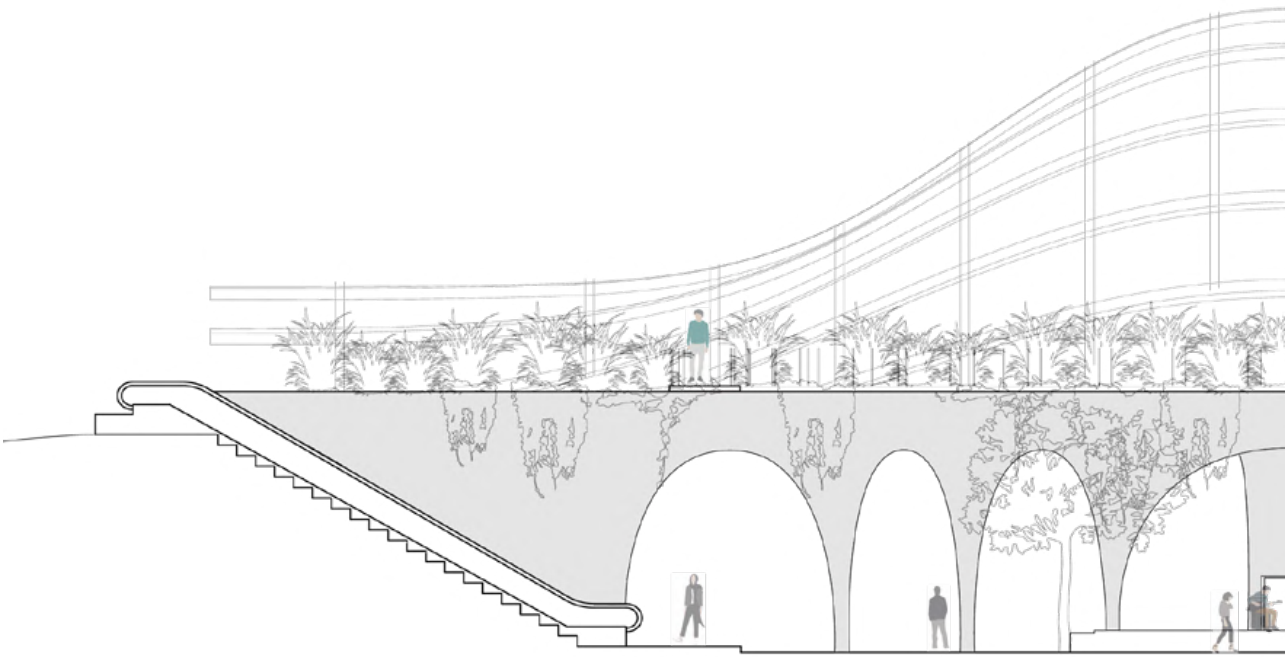

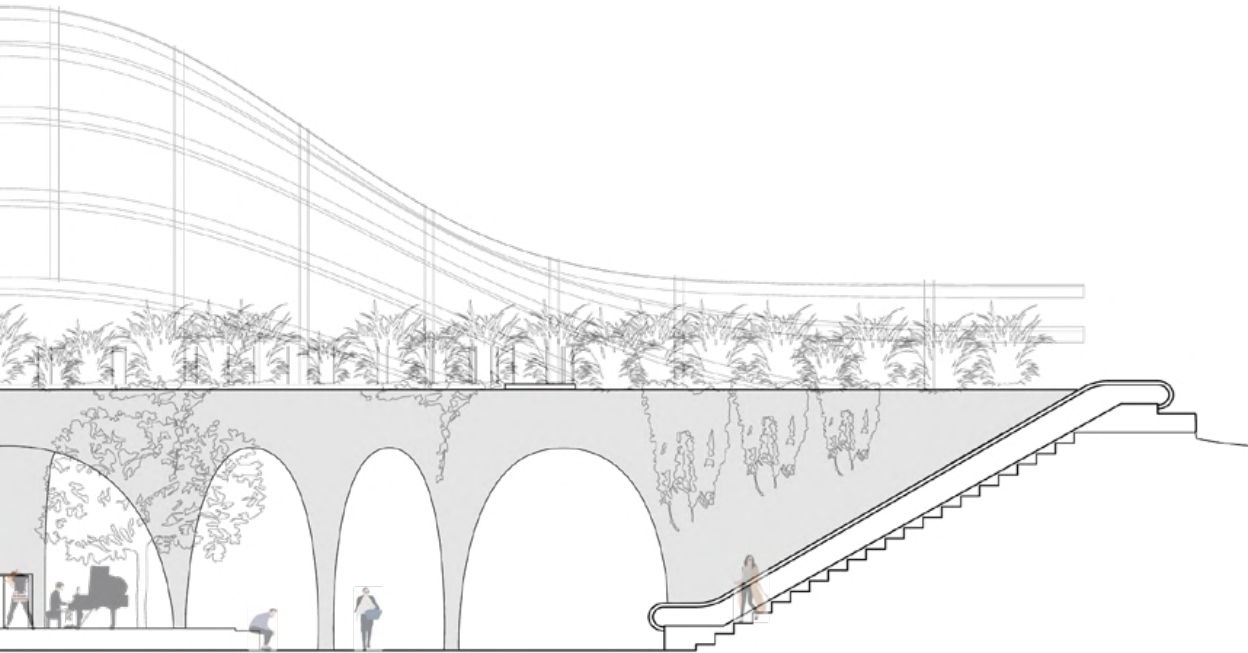





Concourse and Platform Station Design

The Erasmuspark station is designed to be a theatre of people that stimulates interactions and collaborations between people from the two sides of the station. In this theatre of people and ideas, the primary function of metro station becomes secondary. These interactions and generation of ideas are planned to be happen in the upper levels of Plaza under the transparent dome. In this scheme, the lower levels of concourse and the platform are intended to serve the primary function of transportation. They are part of the theme and vision of the station but in a rather subtle way and create a slow transitional experience for commuters from theatre and slow life above to fast moving and digital daily routine and vice versa.

The key goals for the concourse and the platform were:

- Slow transition from cultural hub to transportation
- Relate to the design characteristics, colours, materials of the floor above
- Compact design and efficient circulation
- Support the interaction between the people active

These goals have been achieved using various design strategies. Firstly, rather than adding new elements, the concourse and the platforms copy their characters and materials strongly from the layers above which become simpler in their geometry. The path down from the plaza is full of green and light but as the user turns towards the concourse, these start to disappear slowly giving way to a concourse which has hints of green and natural light. The curvy lines from above are now round openings leading down towards the metro. Thus, the design elements are slowly are moved to the background as one moves forward and down giving way to the primary function of transportation. As one reaches the platform level, the features from above have almost faded away. The straight lines take the centre stage with a curves now visible only in the furniture and lights.

Throughout this journey, the main idea for the station to connect and build relationships in the Erasmus university and the Brainpark remains constant. The concourse level showcases history of the area as well as displays art and installations inspired by various artwork in the Erasmus University. The platform level showcases various events, news, job advertisements etc. from both the sides.



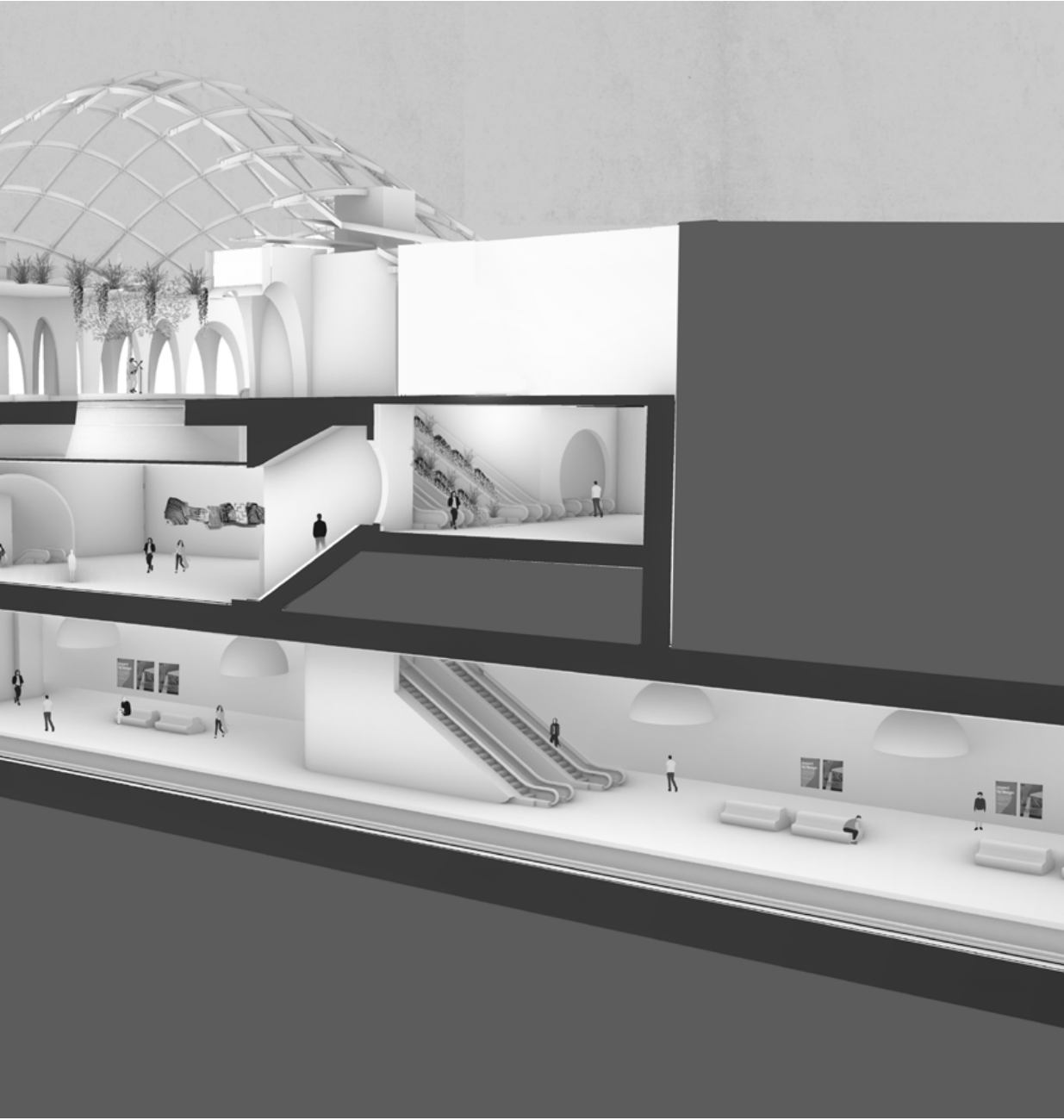

Circulation Strategy Concourse & Platform

Due to the function of station being a stop-station next to the main hub of Kralingse Zoom, the Erasmus-Park station is intended to be a small station for people visiting the area. Thus, the station is designed to be compact and with short circulation routes without long waiting and travel times.

As one enters the Plaza at -6 m, the path to the concourse and platform located on one side along the shorter axis, is clearly visible. Moving down, the upper concourse level is the first change in direction, after one arrives at the main concourse level which offers ticket machines and check-in/-out poles. To avoid bottlenecks in flow, the gated check-ins has been replaced with check-in/-out similar to the Schiphol Airport.

Following the compact design, the accessibility with elevators is also a single step process without requiring to interchange at the concourse level. It connects the ground level and the plaza level directly to the platforms. The ticket machines are located the entry points.

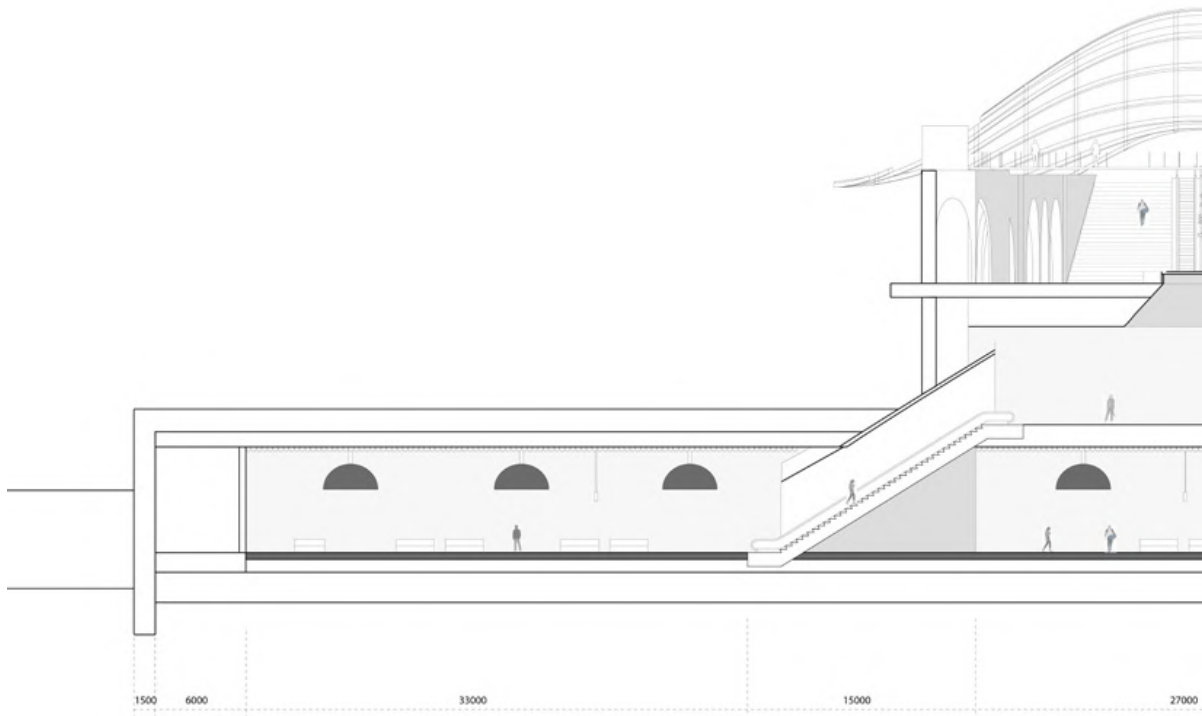
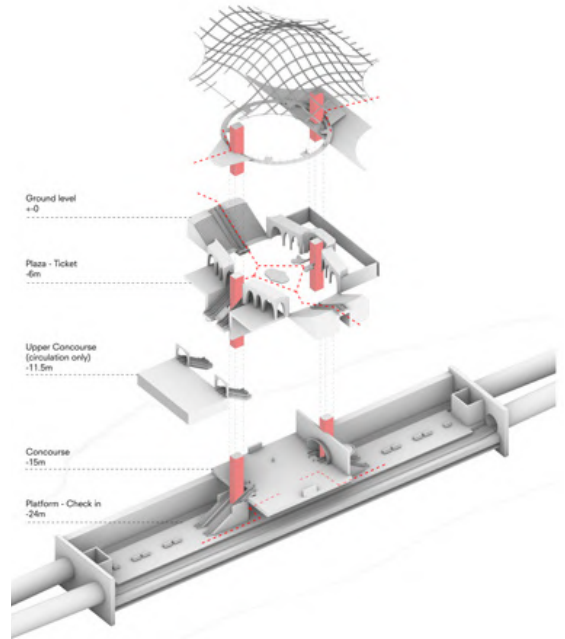

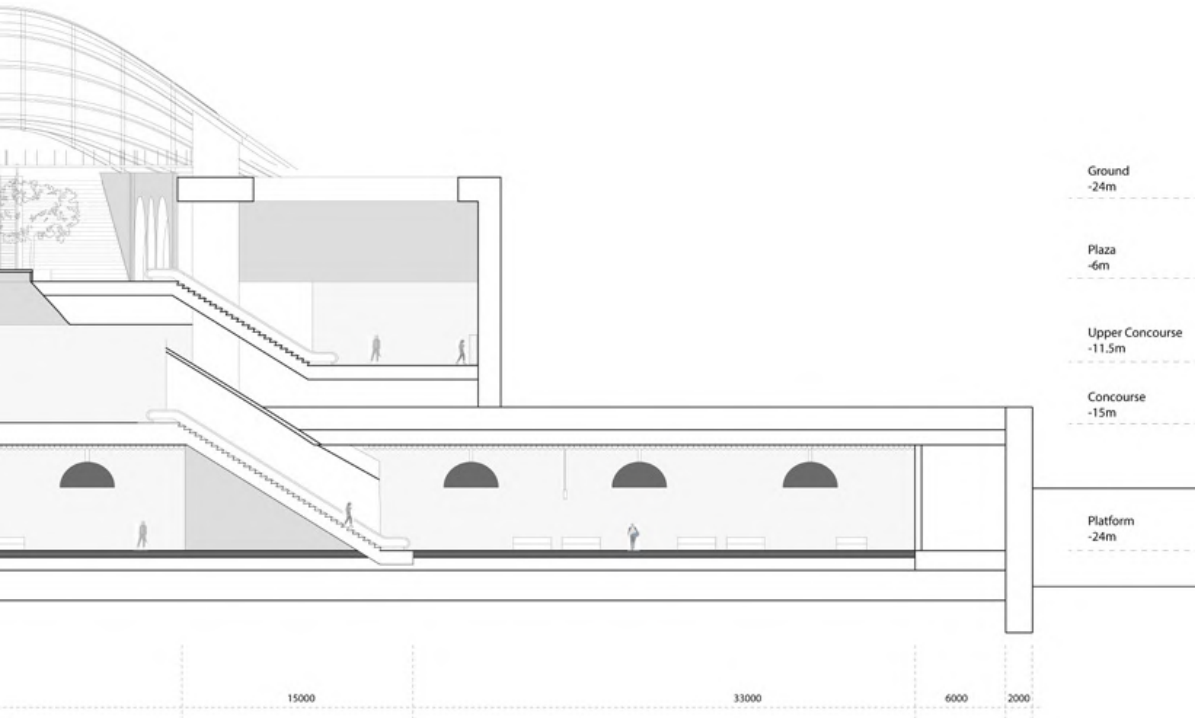
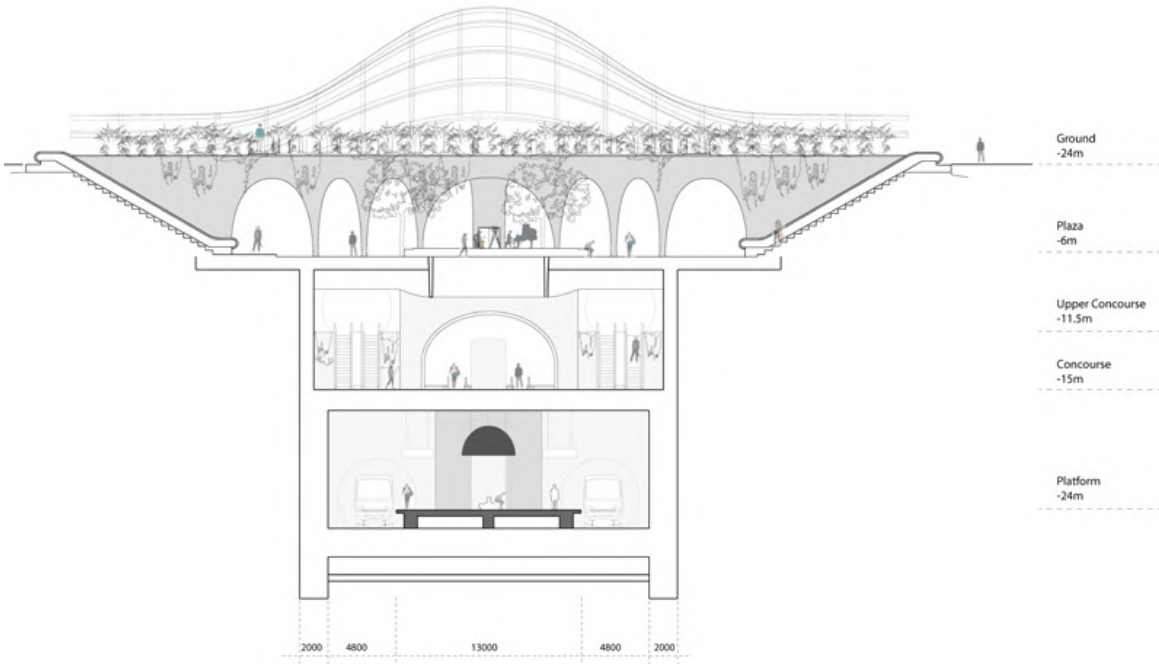



D

DE ESCH

Collective Research Location & Characteristics	253
Conceptual Scenarios Visions	267
Landmark! Amusesch	269
Mind the Gap! The Living Station	291

Julianne Guevara
Mattero Gumirato
Qi Hao
Alice Lee
Maya de Ridder
Julka Veerman
Jesse Verdoes

Site History

De Esch

The Rotterdam Drinking Water Supply Company was established right outside the dikes in De Esch at the end of the 19th century. Much of the current residential organization originates from the grids of water pools used for the company. Between the 1970s and 1990s, a shift occurred in the neighbourhood. The drinking water company needed to expand due to higher demands and relocated east of the site. The resulting land was converted to support the construction of over 2500 homes and this is what is seen today.

There are many heritage buildings that remained from the drinking water company and are still present, such as the iconic water tower which now features a restaurant. Other buildings include the pumping station which is an event hall, the laboratory which is a hotel, and the health centre which currently maintains the same use. These buildings act as landmarks to the neighbourhood, become a hub of activity for the residents, and provide great cultural value. However, some of the oldest buildings in the neighbourhood are located in the historic farmlands founded as early as the 13th century on the southern tip of De Esch.



Aerial photo of De Esch drinking water company
Date: mid 1960s
Source: Ruimtelijkeplannen.nl

Aerial photo of De Esch residential neighbourhood
Date: mid 1990s
Source: Ruimtelijkeplannen.nl



1340

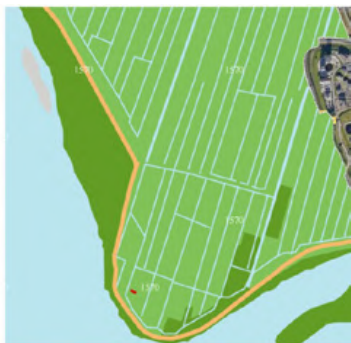

1570



1690



1850



1890



1940



1970



2008

Photo-documentation

Site

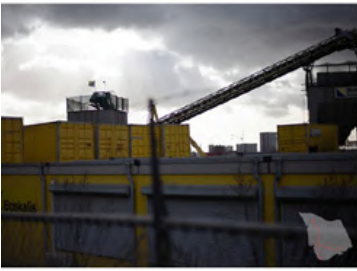

Area Photographs
Date: 12-02-20
Source: Photographs taken by author

First Impressions

De Esch

The area presents different qualities and aspects, sometimes favourable or unfavourable. Firstly, the area seems to be abandoned as few people are seen outside and it is surrounded by nature. However, people can still reach the area with all types of transportation apart from the metro. The most used methods are bicycles and the tram, where De Esch is the terminal stop. Secondly, there is a great presence of green areas.

There are two parks that are connected by a green corridor which thus creates a good habitat for different animal and plant species. In this context, the water defence is also very important and so there are two main dikes. Lastly, the impression of the buildings is that they have varying orientations and densities. In particular, some clusters take their grid from historical uses. In this place, there are also monuments and interesting locations such as the beach, the commercial area, the sports centre.

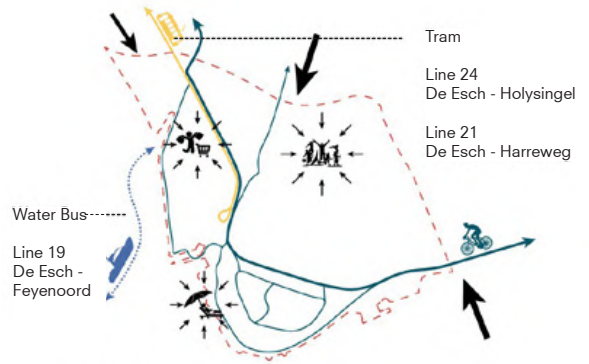

Circulation

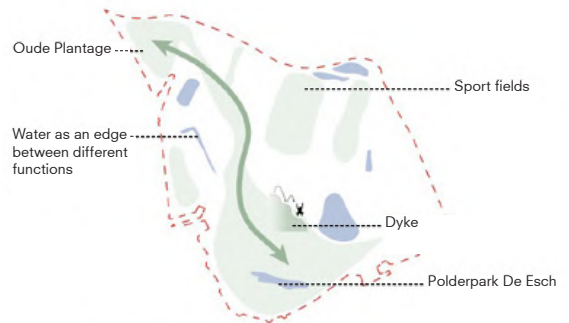

Green Corridor



Rules / No Rules



Oude Plantage

It is the first park in Rotterdam. It is not really used by citizens but It offers beautiful views.



Water Tower

It was an aqueduct. Today you can find restaurants and beautiful views. It is one landmark of De Esch.



The Beach

The small beach guarantees a relaxing moment overlooking the skyline of Rotterdam.



De Rozenhof

It is a monumental farmhouse where you can experience the tranquility of the countryside, looking at the skyline of Rotterdam. It is an attractive meeting location for business meetings.



The Dyke

A dyke could protect you from water but in the same time shapes the ground creating a very interesting environment overlooking the bridge.

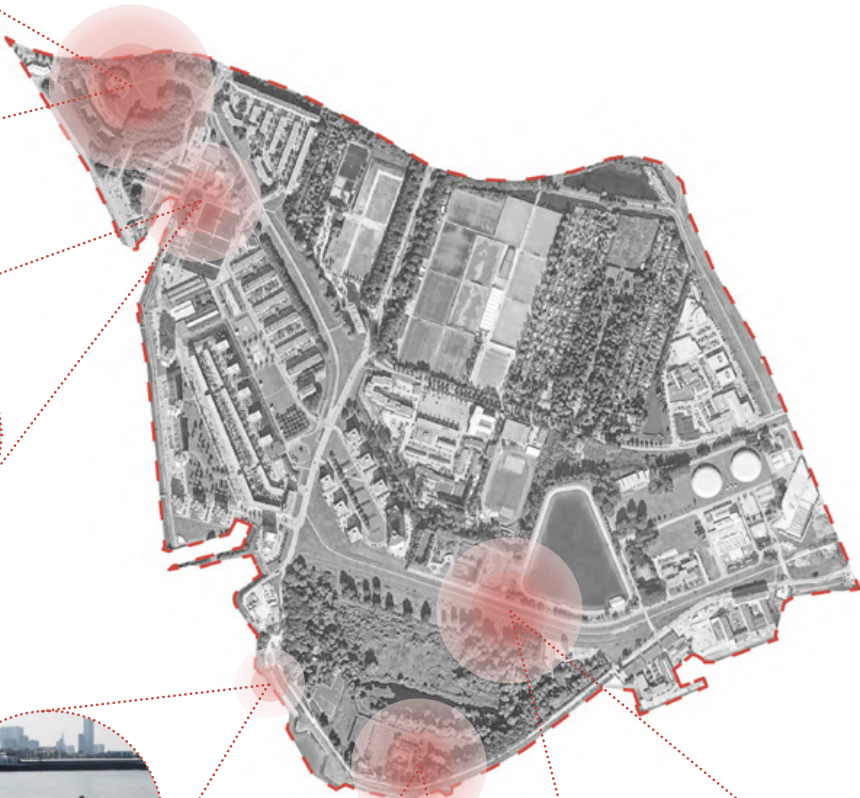



Pumping station building
1884-1888



Laboratory
1870



Water tower
1871-1873

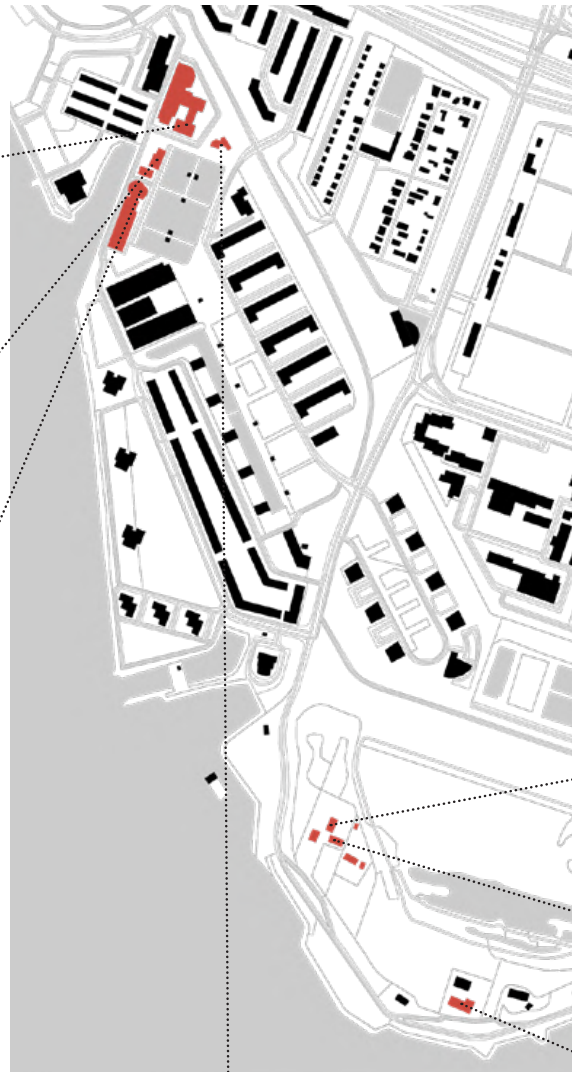

Health center
1887



Jewish cemetery
1890



Farm complex
1800s



Farm complex
1800s



Farm house
1700s

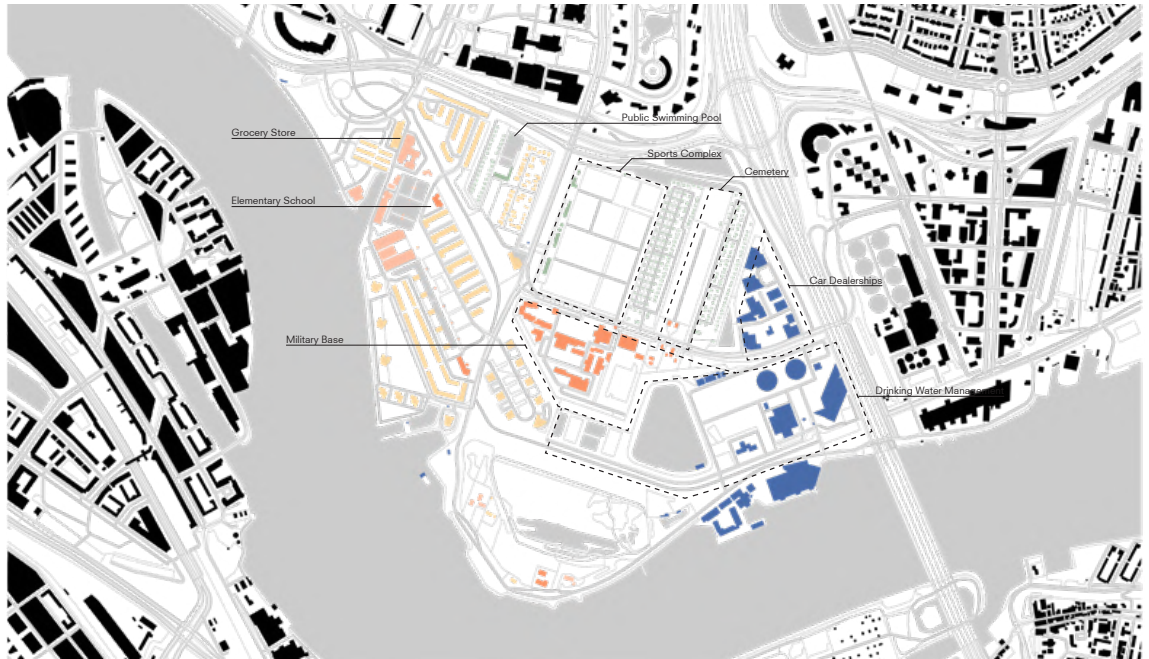

Building Use
Source: Ruimtelijkeplannen.nl/viewer

- | | | | |
|---------------|---------------------------------------|-------------------|---|
| Institutional | ■ | Industrial | ■ |
| Mixed-use | ■ | Sports Facilities | ■ |
| Residential | ■ | Gardening | ■ |

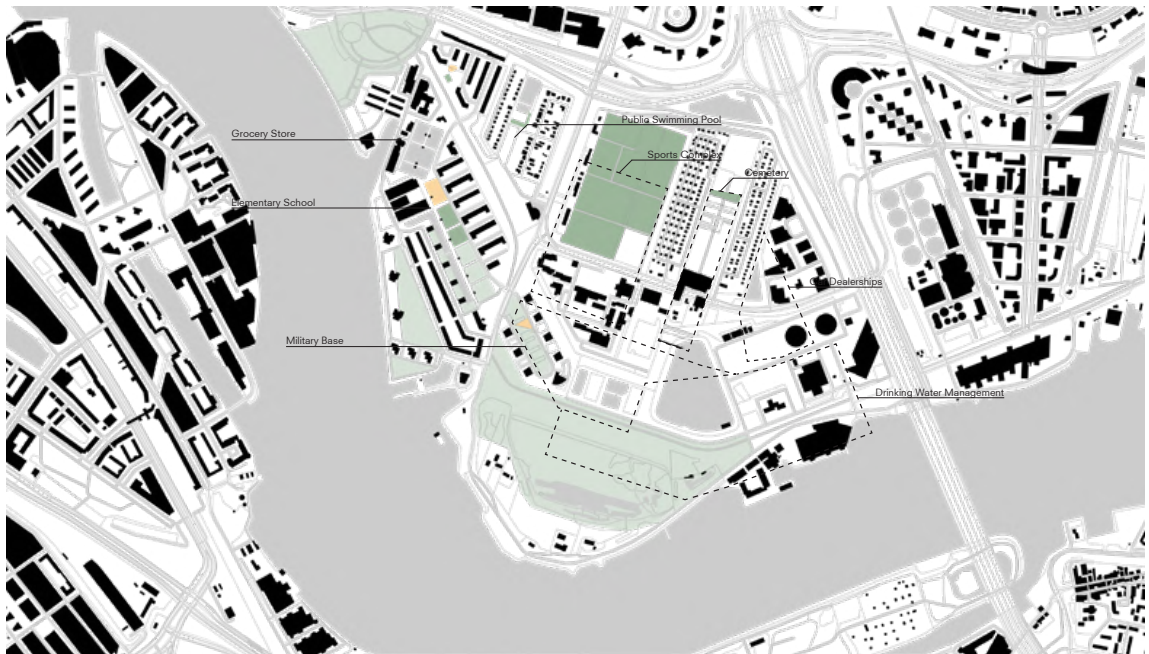

Public Spaces
Source: Ruimtelijkeplannen.nl/viewer

- | | |
|-----------------------|---|
| Park | ■ |
| Sports Amenity | ■ |
| Children's Playground | ■ |



Building Height
Source: gis.rotterdam.nl

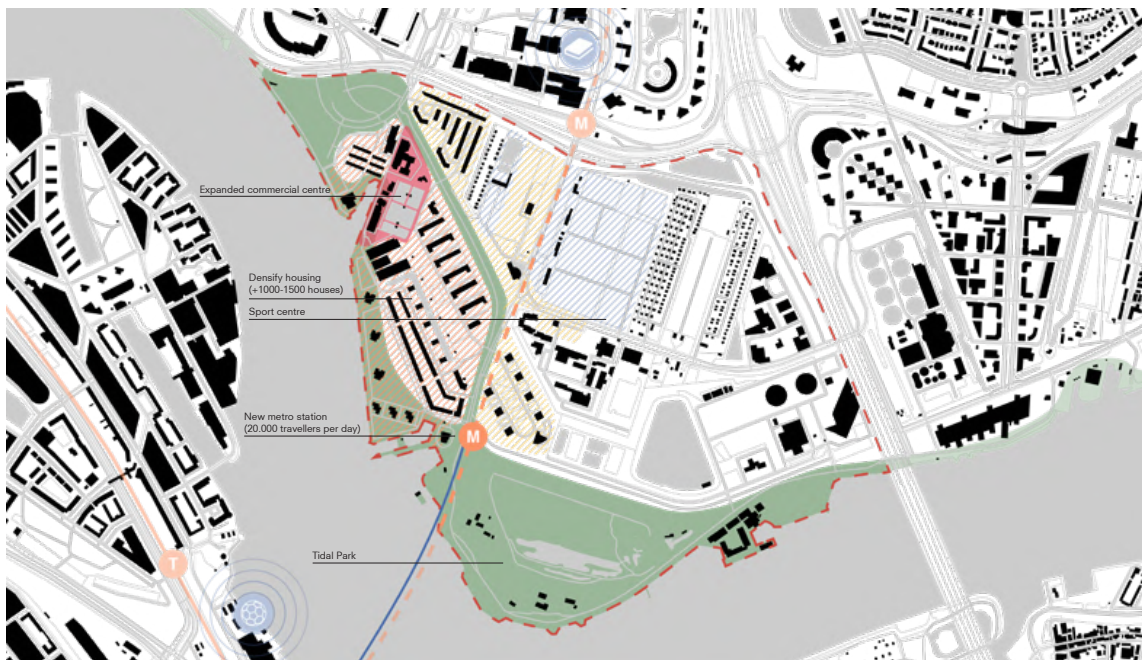
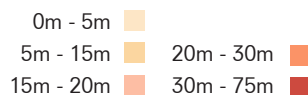

Future Developments - De Esch 2040



Built Context

De Esch

De Esch hosts a diverse range of land uses including residential, institutional, industrial, recreational, commercial, and agricultural. The majority of buildings in the neighbourhood are residential. A significant military training base is located at the centre of De Esch. There are multiple car dealerships, as well as a large drinking water management facility to the east by the highway. To the north is a sports complex with numerous playing fields, a public swimming pool, several allotment gardens, and a historic Jewish cemetery. To the west is the commercial centre with a grocery store and other services. A public elementary school is also located in this area.

The open public space is well dispersed between the buildings, with small parks and playgrounds located all over the neighbourhood. The main amenities however are the Oude Plantage park, the De Esch polder park, and the sports complex with football fields and a skating rink.

The heights of the buildings are mainly mid to low rise, a majority around 10-20 meters tall. There are a few high rise residential towers along the river side, the tallest being 65m. Through the site section the presence of the dike by the river is highly evident.

Various building forms are observed within the area and add character to the built context. These morphologies work in contrast with each other and allow for an interesting diversity in the neighbourhood. Examples include compact vs long and flat vs tall, as well as unique curved and jagged shapes.

The materials found in the area are predominantly brick, with a mixture of beige, brown, grey, and red bricks. Often a pop of colour is used for the railings, windows, doors, and stairs featuring blues, yellows, and reds which adds a more eccentric and vibrant atmosphere to the otherwise monotone surrounding.

Morphologies

Typological Analysis

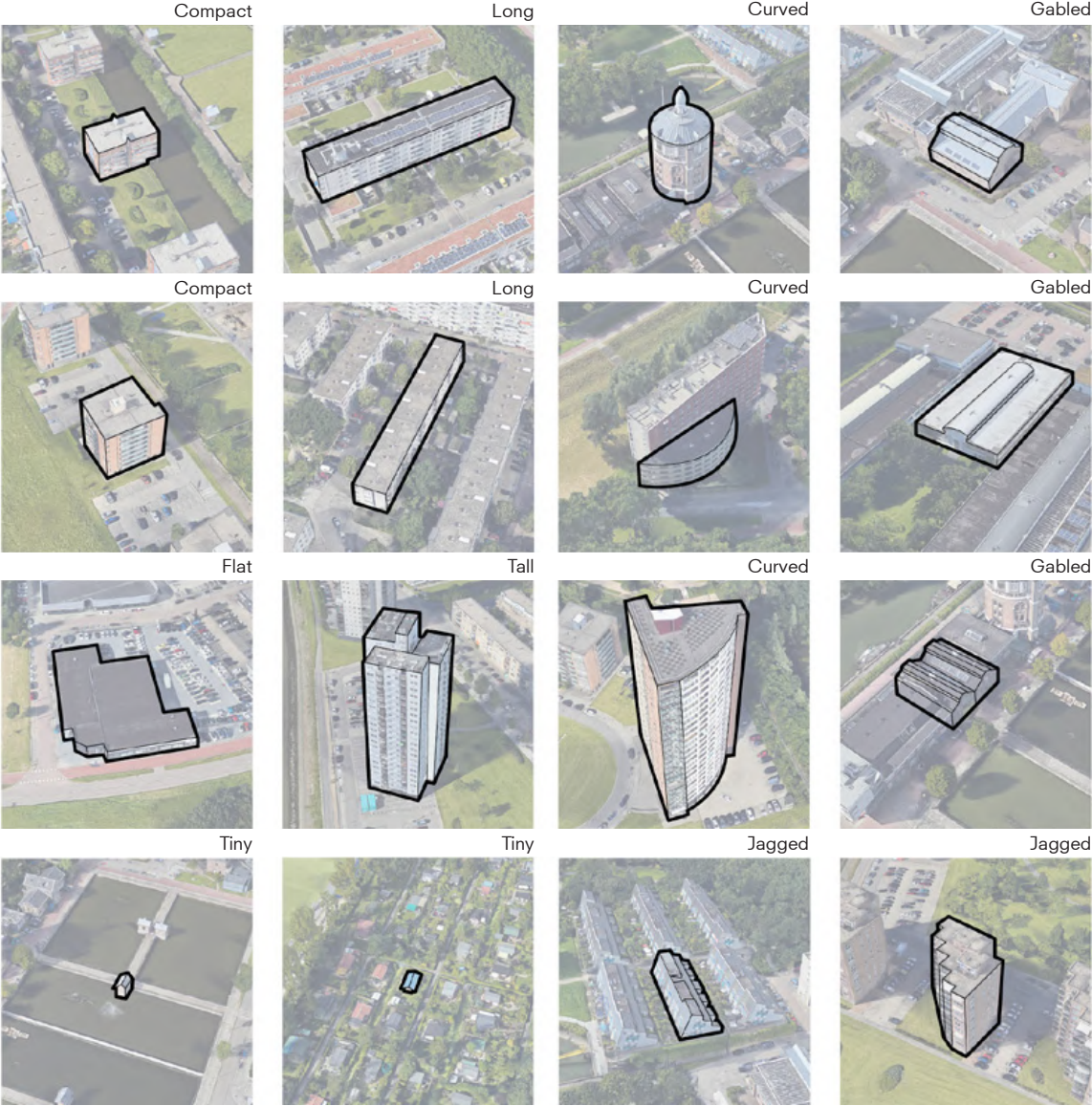

Infrastructure & Circulation

De Esch

The road system in the Esch can be divided into 4 levels. First, the Abram van Rijckevorselweg and the A16 national road, 2 arterial highways in this site, is part of the main road network of Rotterdam and therefore give the Esch access to the surrounding city area. Second, several sub-arterial highways, like the Kralingse Zoom and the Honingerdijk, have two main connection in the north with the Abram van Rijckevorselweg, but only have one weak link (for bike) with A16 in the east. These roads are 50 km / hour roads. The remaining two levels are all low speed roads (<30km/h). Only a few of them are public roads and the rest are internal roads. The shortage of public roads and the weak connection with A16 more or less cause congestion problems during peak hours. This might be an important problem to be solved.

From the location of the public transport stops, we can also observe the comparative advantage of the accessibility in the north. 12 bus lines and 3 tram line pass the north area, while only 2 tram lines go into the Esch, and 1 ferry is located in the south. This indicates a shortage of public traffic in the east and south area, which results in an imbalance of accessibility. However, the slow traffic system in this area is distributed evenly. This could be an advantage and characteristic to carry forward and promote in the future.

In the long term, the City Vision speaks of a desired over-connection between the North and South banks. But the government does not share this desirability because the cross-river connection will have spatial consequences for the DWL-de Esch area, and they are afraid to disturb the original quietness and the natural atmosphere. However, from our preliminary study of the space syntax, we found that the Esch and the south bank now have a good "To-movement" potential, but have a weak "through-movement" ability. It means that there are opportunities for commerce and public activities while the accessibility and traffic convenience are not enough yet. Therefore, it is reasonable to build one or more bridges to connect the north and south banks. "How to develop the accessibility and do not destroy the original calm atmosphere at the same time" become the most significant question to be answered through our further design.

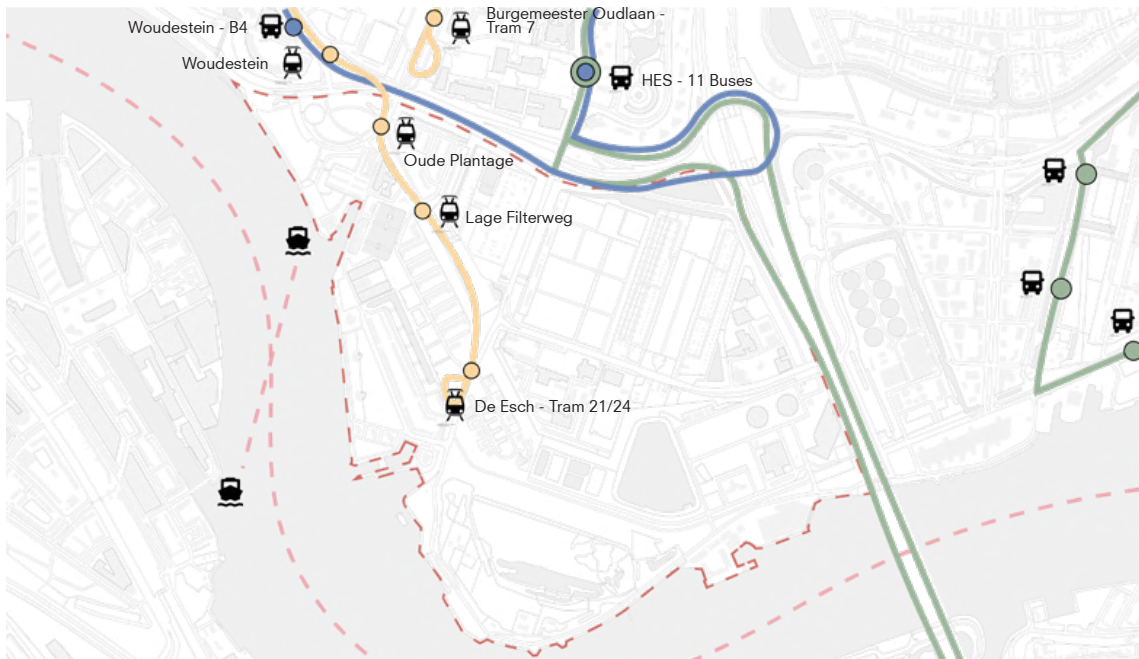

Public Transportation



Bicycles and Pedestrians

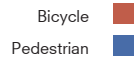

Vision 2
Mind the Gap!

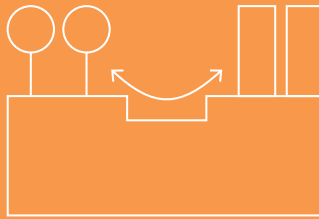

Nature - Built Environment - Transition

Densification - Urban Value & Identity

Public Space - Landscape - Materiality

Maya de Ridder
Julianne Guevara
Julka Veerman
Qi Hao

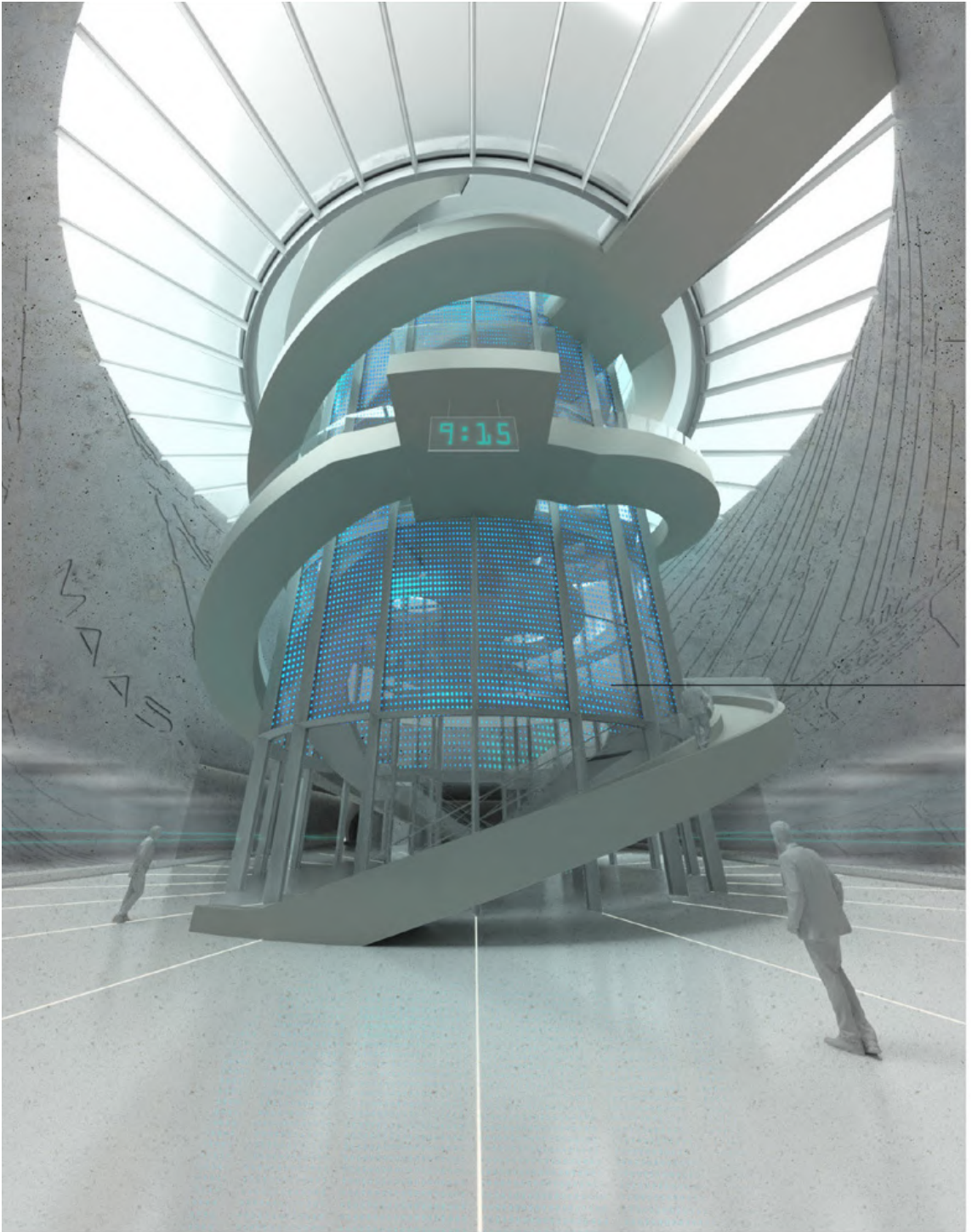

Amusesch

De Esch Station
Landmark!

Matteo Gumirato
Alice Lee
Jesse Verdoes

Design Exercise

Collage

The collage serves as the conceptual starting point for the design. It consists out of two parts: The Tower and The roller-coaster.

The Tower

When we arrived at De Esch for the first time, our first thought was disorientation. The general analysis showed us why: the typology of free standing buildings. Because they are all similar to each other, it is not correct to call them landmarks. Perhaps, it would be functional having one landmark, recognizable by distance, giving structure to the area.

In this sense the project concept is a tower usually finds at amusement parks. From the concept, the idea is to design a tower in which to include some functions like an automatic system of bike sharing and lifts that bring you to different levels.

The Roller-coaster

The second part of the collage is The roller-coaster. The roller-coaster, like in theme parks, are recognizable structures which take users to a destination. Travellers will know where they are going when they hop onto it, or where they are if they see it. The metro station skybridge complex therefore becomes De Esch's important wayfinding system. Taking reference to the wayfinding system in English gardens, one can easily spot another monument when one reaches a monument in the garden. The metro station will become a recognizable structure in the area, unifying the neighbourhood.

Landmark & Wayfinding

Concept Summary

In the current situation, the Esch has a very unclear structure from eye-level. This is a consequence of the typology of mainly free standing buildings, they do not give direction (see analysis next page).

The station will have 2 functions:

1. Going to the station: It is a point of reference, a landmark. The tower has the function of the landmark. The station is strategically placed along different axis in the Esch, not only making it visible from the main points in the area but also connects the landmarks in the area (English garden effect, see analysis green structure).

2. From the station: Give direction
The roof and the bridges have the function of giving direction.

The direction of the roof is (1) a counter to the direction of the bridge, which divides the Esch into two parts; (2) connecting the green structure, public spaces of the Esch. When you come out of the station, the first thing you see is either the old water tower or the new bridge, both points of orientation. The bridges of the station will lead to specific programs in the Esch: public space, sport fields, tidal park and the commercial area. The bridges help with wayfinding as the destinations are visible from the roof, so one sees where the bridges lead to.

Disorientation

Due to the morphology that is present in the Esch, there is no clear structure. When arriving at the current tram station one feels disorientated. This is caused by the undefined space surrounding the area and the lack of visibility of reference points like the water tower (which is barely visible).

Another point is that the site is close to the river, but the river is not visible at all.

The design of the new metro station should structure the site, define a space, give direction. Furthermore, a platform that is elevated from the ground could lead to a better visibility of the river and a better visibility of the water tower.



Aim 1: Orientation

'In the Middle'

De Esch has various areas consisting of different functions located across the district. It has residential, institutional, public sports facilities and green areas including a nature reserve, a large park and a small beach. However, these areas are loosely connected, disoriented and quiet. People and traffic flow mainly concentrate in the S107 highway, as this is the main road from the centre of Rotterdam to southern Rotterdam. The design proposal aims to densify, connect and provide better orientation for users in these regions and to re-distribute the heavy traffic flow in S107 highway across De Esch.

The newly proposed metro station will be placed at the terminal station of tram line 21 and 24, Nesserdijk station. It is within walking distance for the residential, mixed-use, institutional, sports facilities and green areas. The metro station will become an important hub connecting different regions in De Esch.

The station is placed at the current place of the tram, which makes efficient transfers possible. Furthermore, with the new connection to the south, a new bus station is wanted. The bus stop can be part of the design as the place of the metro station is next to the main road.

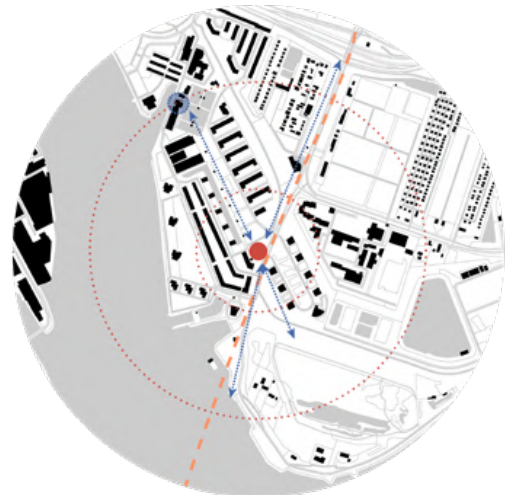

Views for visibility



Functions

Aim 2: Efficient Mobility

“From A to B”

The station is situated as a visible point in the green structure. In this way the station functions as a landmark within the structure.

People moving along the green structure follow the landmarks, they go from the one to the other. For example, from the water tower to the metro station to the tidal park. This concept is related to the romantic English gardens, where view axes were set up to ‘lead the way’. From one point to another, a logical and visible sequence.

Secondly, the station will function as point of arrival for visitors of the green area, due to the higher situated roof the tidal park is immediately visible when arriving at the station. One of the bridges then connects the station with the park.

The new bridge, and thus busier road, will split the Esch in two. Furthermore, the important facilities are spread over the area. The station connects the two split up parts and provides routes to the important facilities (sports, tidal park, public space, commercial area etc.)

The station should provide efficient mobility in three ways:

1. All transport at one central point

Transfers to another transport should be quick and nearby. The transports available are: Shared mobility (bikes/scooters), metro, tram, bus and cars (just for pick up drop off)

2. Divide infrastructural layers

A division of infrastructural layers will provide a clarity to the traveller. The division is as following. 1 metro line, 2. transfers (ground floor), 3. bikes and pedestrians (roof level).

3. Bridges

The bridges will take the traveller to the most important points in the neighbourhood. As they are situated above the normal ground level, they provide better orientation and safe transportation.

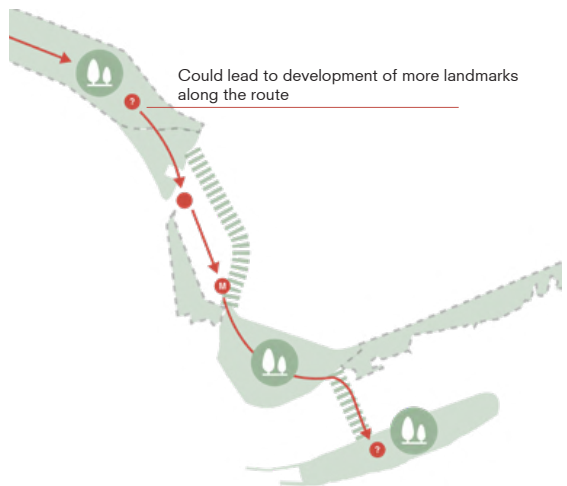

Green Corridor

Providing Structure History

In an analysis of the history of the Esch, we see how a primary structure can provide a controlled future development.

The history of De Esch shapes how the district is developed over the years. The water tower in De Esch is the oldest existing water tower in the Netherlands. Early developments were developed around the water tower. The waterworks company relocated to a different location in 1978, the houses and workplaces were replaced by different cooperatives. The water tank has been replaced by office spaces. The tower is currently occupied by a cafe and restaurant and the top floor is used as an office. Current retail and commercial development continue to concentrate near the water tower. Therefore, it will be ideal to connect these built areas to the green areas in De Esch and southern Rotterdam by bridge.

The Development

The proposal is to be built in stages with the flexibility for possible program changes as the construction progresses. The first stage of the program is the addition of the bridge between the nature reserve and the Stadium Park. The bridge addition will very likely divide the built area and green area into two halves. The second stage will be the construction of the metro station and the series of sky bridges spreading across the area to connect the distinctive areas. The third stage of development will be densification in the areas surrounding the metro station of sky bridge network along with transportation infrastructure such as boats or ferries for travelling across the river. By 2040, a second bridge for pedestrians and bicycle users might be added to connect the other part of the nature reserve and Eiland Van Brieneoord, which is a green area in southern Rotterdam so as to extend the green corridor network.

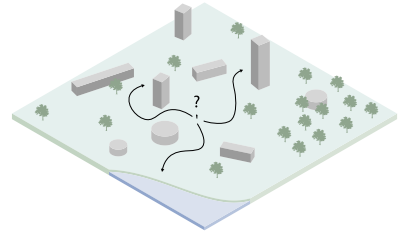

Disorientation

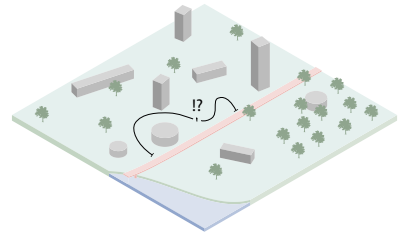

Bridge

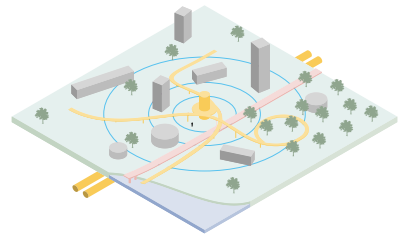

Connection



Centre for development



Densified

The Tower and The Roller-coaster Design

For the design, we elaborated the Tower and Rollercoaster concept of the first collage. On the right, you can see the one for the Tower. It is depicted as a lighthouse as it is supposed to function as a point of recognition. Furthermore, the tower does not only have a function above ground, but also functions as a landmark below the ground. The spiral staircase shows how the tower contains the main vertical infrastructure of the station. As for the roller-coaster concept, it is illustrated through a recognizable structure that provides unity in the neighbourhood. The rollercoaster has certain points that are most exciting. These points refer to important areas in De Esch of which the station will be part.

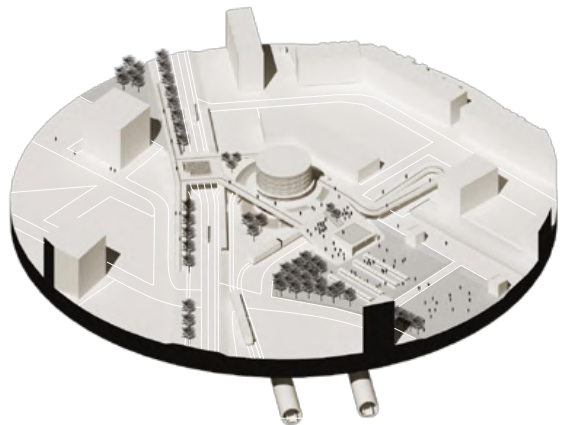
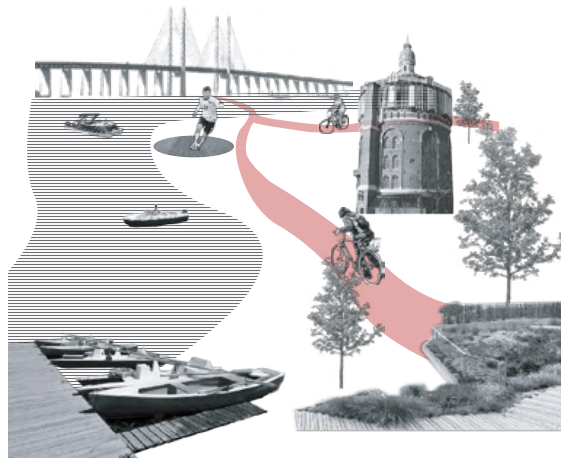
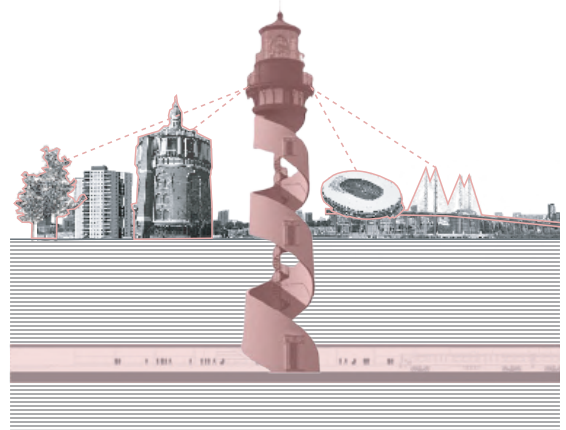

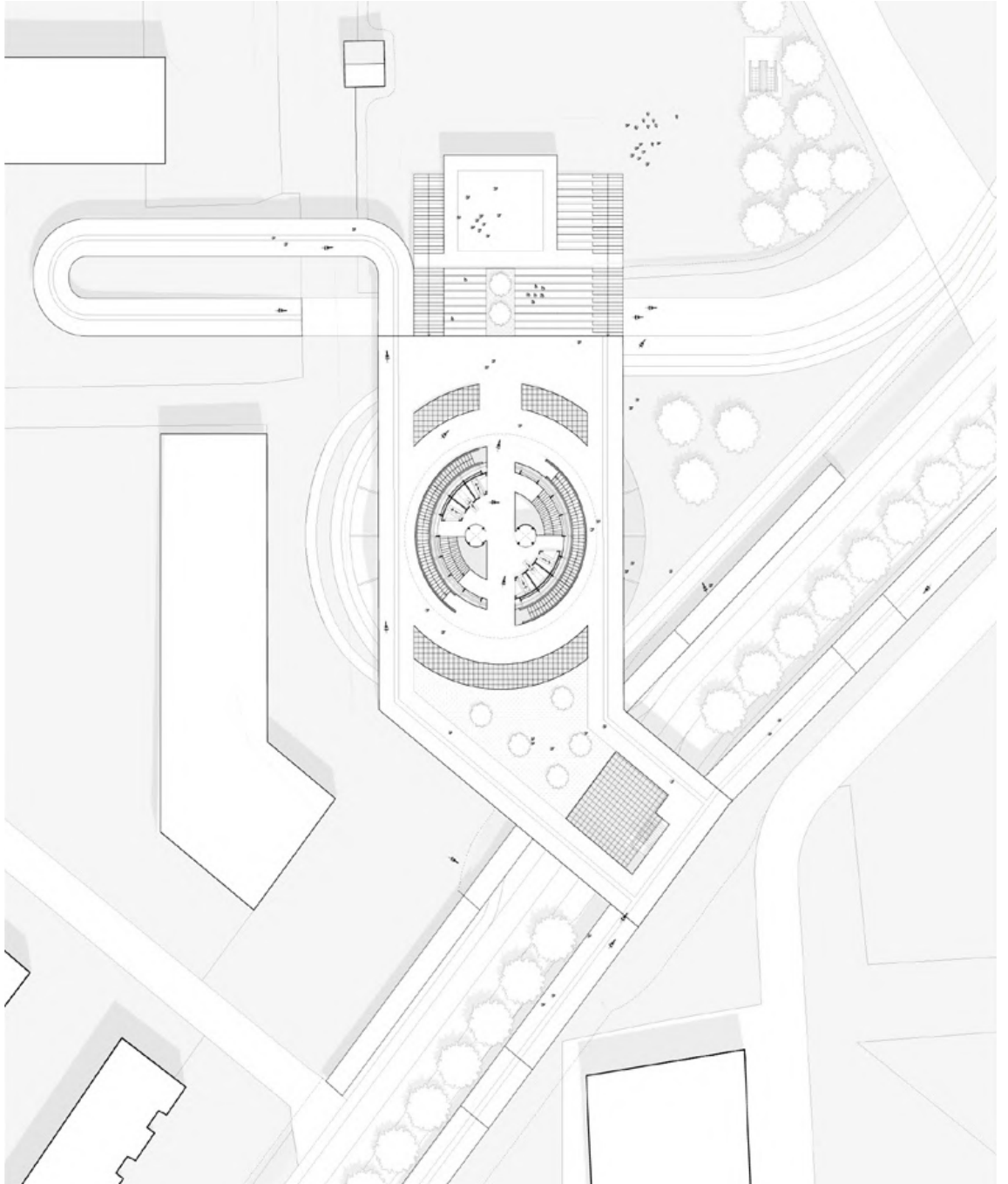

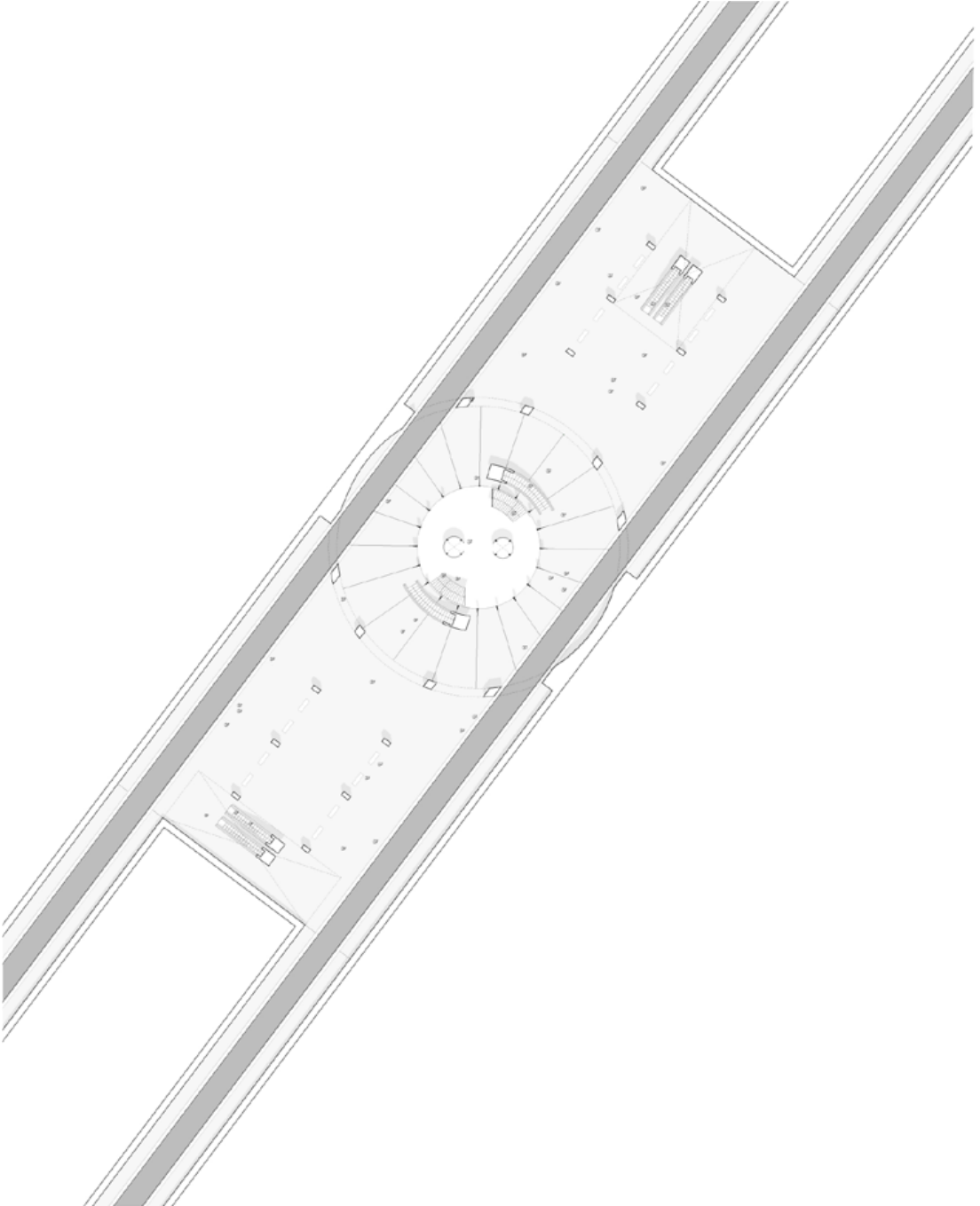

The Interior Landmark Underground Station

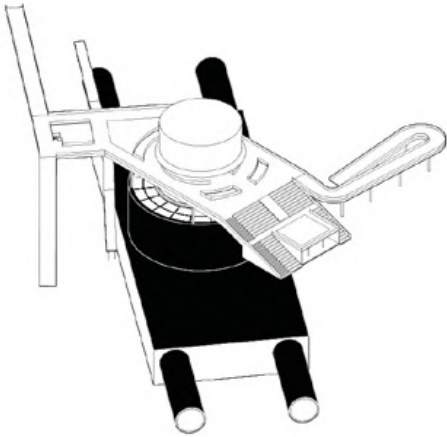

A metrostation that can give identity can be of great value for an upcoming neighbourhood like the Esch. In the foreseeable future, it will see great densification. The station is one of the projects that will have influence on this development as it functions as one of the entrances to the area. It could even be the literal starting point. Thus, it is of importance it will be able to 'set the tone'.

The cylinder is the core of station. It towers up above the roof and exposes the station to people in the vicinity. However, as the tower punctures the ground until it reaches the platform, it does not only have an exterior function. It is also: the interior landmark.

This central part of the station will be thing that people remember: a point of recognition. Even from the metro, travellers will be able to see the structure. It contributes to the aims of this project: providing orientation and a new identity for the Esch.

The cylinder forms the main vertical connection between the platform and the ground floor and roof. To emphasize its importance, it is situated in the exact midpoint of the station and its platform, it is the hinge of the building. Under the ground, the verticality of the cylinder breaks up the long, directional shape of the platform. Everything on that level is set up in such a way that it will direct the travellers to it. Outside of the cylinder, the lines on the floor and lights on the ceiling emphasize the direction. Furthermore, the roof seems to be formed out of the walls of the cylinder that are bent horizontally. Moreover, use is made of daylight, which is let in through the roof windows of the cylinder. Thus,

in one clear vertical gesture, travellers get 'lured' to the surface.

However, it is not just a way up, it is an experience, the 'attraction' of the Esch. It challenges the normative ways stations are designed as purely functional and efficient structures. The functionality of such public, infrastructural buildings is of course necessary, but it does not mean that it cannot be more. Stations can also be fun, inspiring, stimulating. This is why the vertical connections are situated in and around the internal cylinder, and designed in such a way that the station can be fully experienced. They wrap around a slender steel structure. In between the columns, big glass panels provide stability. In these panels, there is an interactive, transparent LED-light system. Through sensors, the movement of people in the cylinder is magnified by the lights. The colorful pattern that therefore appears on the facade is constantly moving and changing. It not only gives the travellers on the platform something to look at while they are waiting: the interactivity makes people aware of their effect on the surroundings. As the small cylinder stands symbol for the future of the Esch, the interactivity emphasizes the role of its inhabitants in it.

The future is framed by the past and so it is in the station. The lightweight structure of the internal cylinder is surrounded by a heavy concrete external cylinder. It stands for the base, the roots of the Esch. This is visualized in the facade by showing an old map of the area in the texture of the concrete, emphasized by the daylight coming from above.

The cylinder is the interior landmark, the experience of the station.

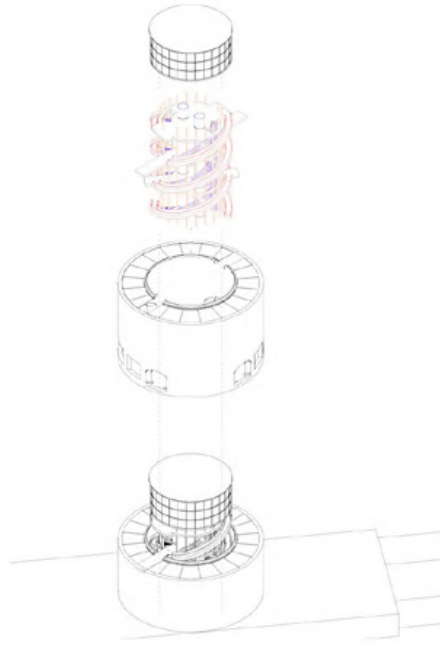

View of the Vertical Connection
Exploded Axonometric

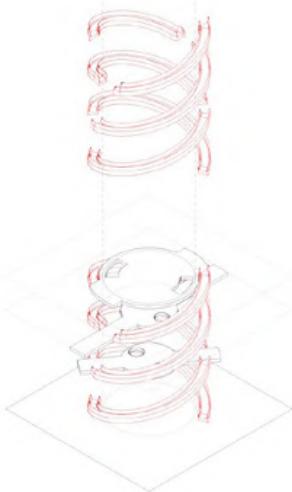

Escalators

The spiral escalators work almost like an inverted slide; you get on and move to another place in an exciting manner. The spiral shape makes travellers fully experience the structure in their way up. The escalators are situated just outside of the inner cylinder.

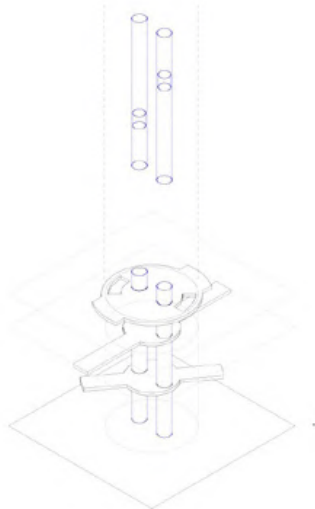

Elevators

The glass elevators are situated inside the cylinder. They are made of glass. Not only going up by elevator will be an experience, it also adds a dynamic element to the station. People on the platform will be able to see the elevators moving up and down.

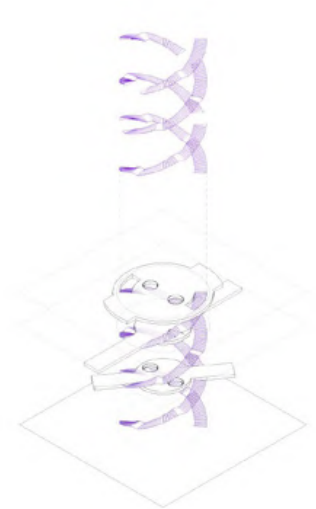

Staircase

People can move upwards and downwards in the structure, take a rest on the balconies and enjoy the view. The staircases are situated next to the glass panels. The facade will contain an interactive and informative projection which emphasizes the movement of people in the core.

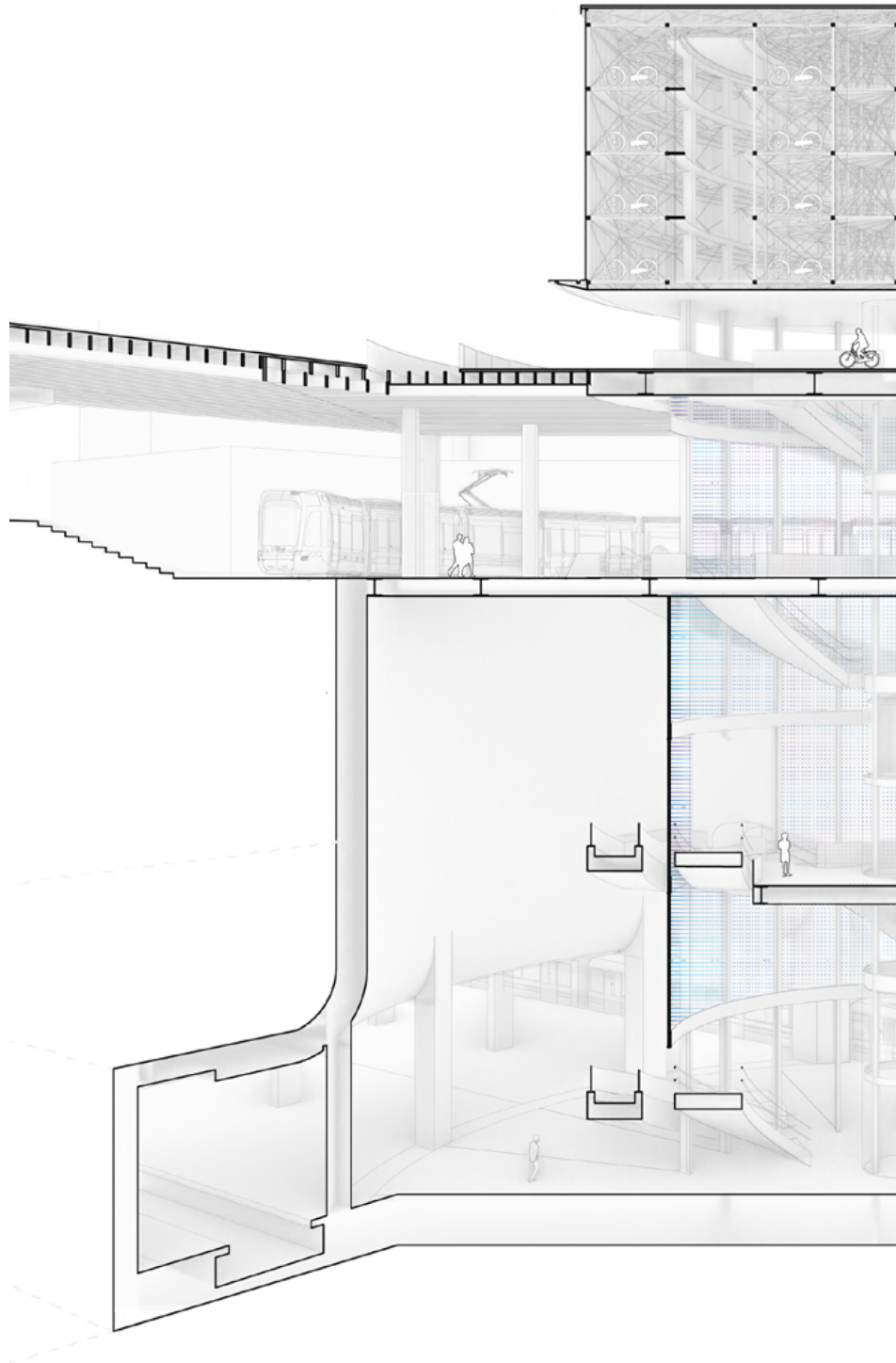

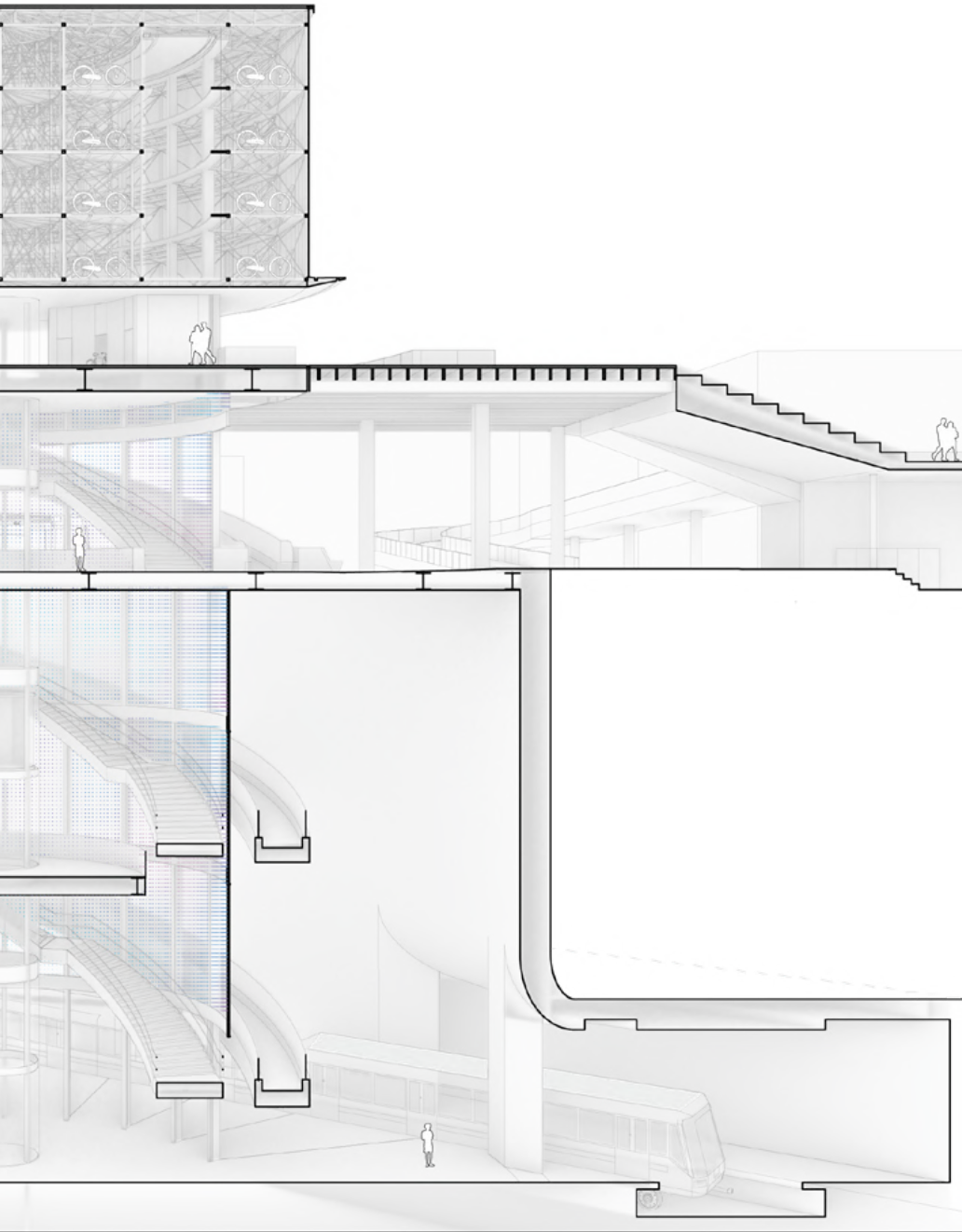

Bike Sharing An Amazing Machine

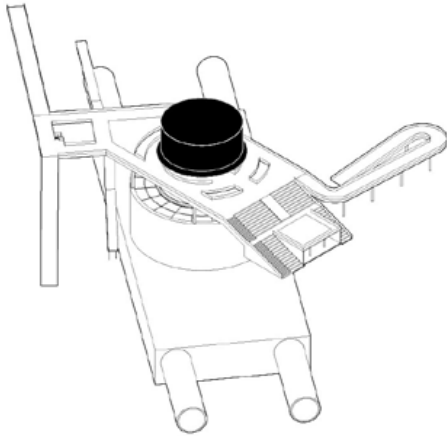

The aim is related to the concept of having an underground and above the ground landmark. In this way, bike sharing becomes important due to its position and relationship with the context.

For the future development, many people are expected to come here, therefore, many transportation facilities will be necessary. Due to these aspects, a new bike sharing system is fundamental as natural surroundings will not increase car usage apart from the new bridge. In trying to imagine how this development could be, it is clear that a view from the surroundings is necessary at all times. This means bike sharing has to have a great importance by day and by night. Thus, the devised fully automated bike sharing system is situated inside the station's cylinder on top. The tower is hereby not only a landmark, but is also a functional item. The semi-transparent facade of the bike sharing system communicates this function to the traveller with the main material being polycarbonate.

It is useful to illuminate part of the station roof, and one can see it clearly from afar. This semi-transparent material gives also the possibility to show the complex machine inside. It is a savvy device for attracting people and giving an identity to the metro station.

Nonetheless, one single element could have different functions, not only in the strict meaning. The same strategy is used for the ceiling as it is also made of transparent polycarbonate. It permits to look at machines from below.

Furthermore, another positive aspect is its malleability. In fact, an important theme is the automated system of bike transportation. Additionally, in order to factor in its maintenance, the project simplifies the actual system.

For example this is done using the material in panels. One can disassemble a panel to enter the cylinder. Moreover, all the mechanical machinery is situated on the roof of the cylinder and below the main structure. Therefore, should the structure require maintenance, there is a series of "catwalks" which permits all-round access. The dimension of the bike sharing cylinder is related to the escalators below. Indeed, the diameter exactly covers the escalators with a brass shelter that goes all around with a projection of 1.50m. It is a special shelter, it seems, for its shape, to be slim and with a LED system aimed at lighting-up the area below.

The bike sharing cylinder will fly during the night! An interesting characteristic is given by special panels. They are made of glass with high-tech pixels. These panels give travellers information such as directions or timetables. The main structure is made of steel square profile and steel tie beam. It is hanging on the roof and works as a solid structure.

The main pillars with "T" sections, arrive from the metro platforms underground. This demonstrates the presence of a coherent project between the bike sharing and the cylinder underground. Special attention has to be given to the roof as it has to be sturdy enough to support its structure. It also has a rotating platform with steel cables that transport bikes to the correct lots. This bike sharing facility can host 350 bikes. The station provides 6 bike elevators and 4 locations with touch-screen panels useful to rent a bike, further embellishing the users' journeys.



Welcome traveler!
Here you can have many different amenities. You can take escalators or lifts to reach tram or metro platforms, enjoy relaxing green area or sitting in the open theatre. You can also rent a bike to enjoy this amazing location!

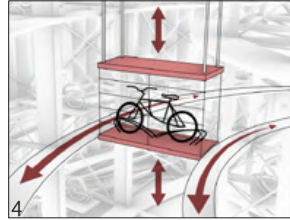

This is an amazing machine!
The box can move up and down or in circle through binaries. There is no friction because the system is using special bearings.



Do you need a bike?
Choose one through the touch-screen panel and pay with your credit card. It will take only 2 minutes!



So finally, after waiting at the right elevator the touch-screen told you before, you can take your bike and enjoy your journey!



Once you have paid something over your head is happening!
The transportation cage is taking your bike with automated mechanical arms.

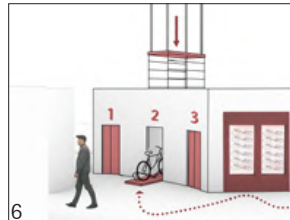

How was your trip man?
Before all go to the panel and check out if everything is ok.
Then reach the right elevator and leave the bike.
Thank you and see you soon!

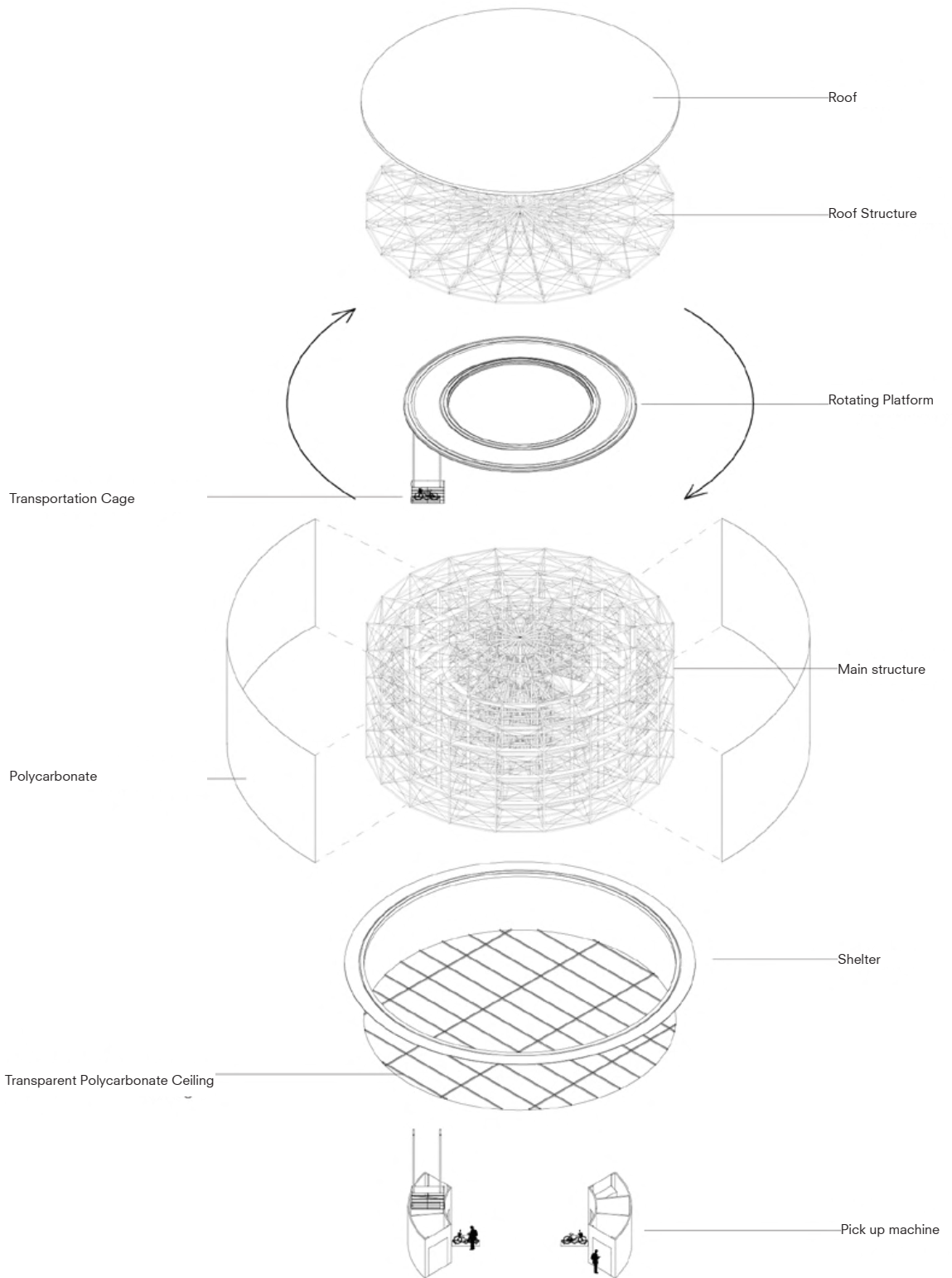

1. Roof Package:
 - ZINTEK sheet metal
 - Seal coat
 - Steel profile 30x30 mm
 - Truss: stringers made of steel profile 100 x 100 mm
 - Wlided tie beam 50 mm
2. Copper gutter
3. Brass flashings
4. Stainless steel fixing pin
5. Fixing plate
6. Steel tie beam 30 mm
7. Satin Polycarbonate t. 2 mm, light trasmission 80%
8. Rotating platform made of steel struss structure, surrected by the shelf connected to the main pillars. In beetween there are bearings to avoid friction.
9. Wheel on binary
10. Steel beam 100 x 100 mm
11. LED light
12. Vertical upright 100 x 100 mm
13. Fixing plate
14. Bike rack
15. Pillar, T section 500 mm
16. Bike transportation system linked to the rotating platform with steel cables
17. Metal binary for bike box movement
18. Steel spheares to avoid friction and permit skidding
19. Mechanical arms to take and to bring the bike in the right position
20. Steel catwalk for maintenance
21. Shelter:
 - KME, TECU Brass sheet, T 1 mm (tilt 1%)
22. LED light
23. Rectangular steel profile 100x250 mm
24. Horizontal partition:
 - Bike track
 - Steel profiles 100 x250 mm
 - Fixing system for countertop
 - Plastic frame 80 x 80 mm
 - Transparent Polycarbonate panels
25. Vertical partition:
 - Information panel 60 mm
 - KME, TECU Oxid Sheet, T 1 mm
 - L profiles
 - Steel frame 50 x 50 mm.

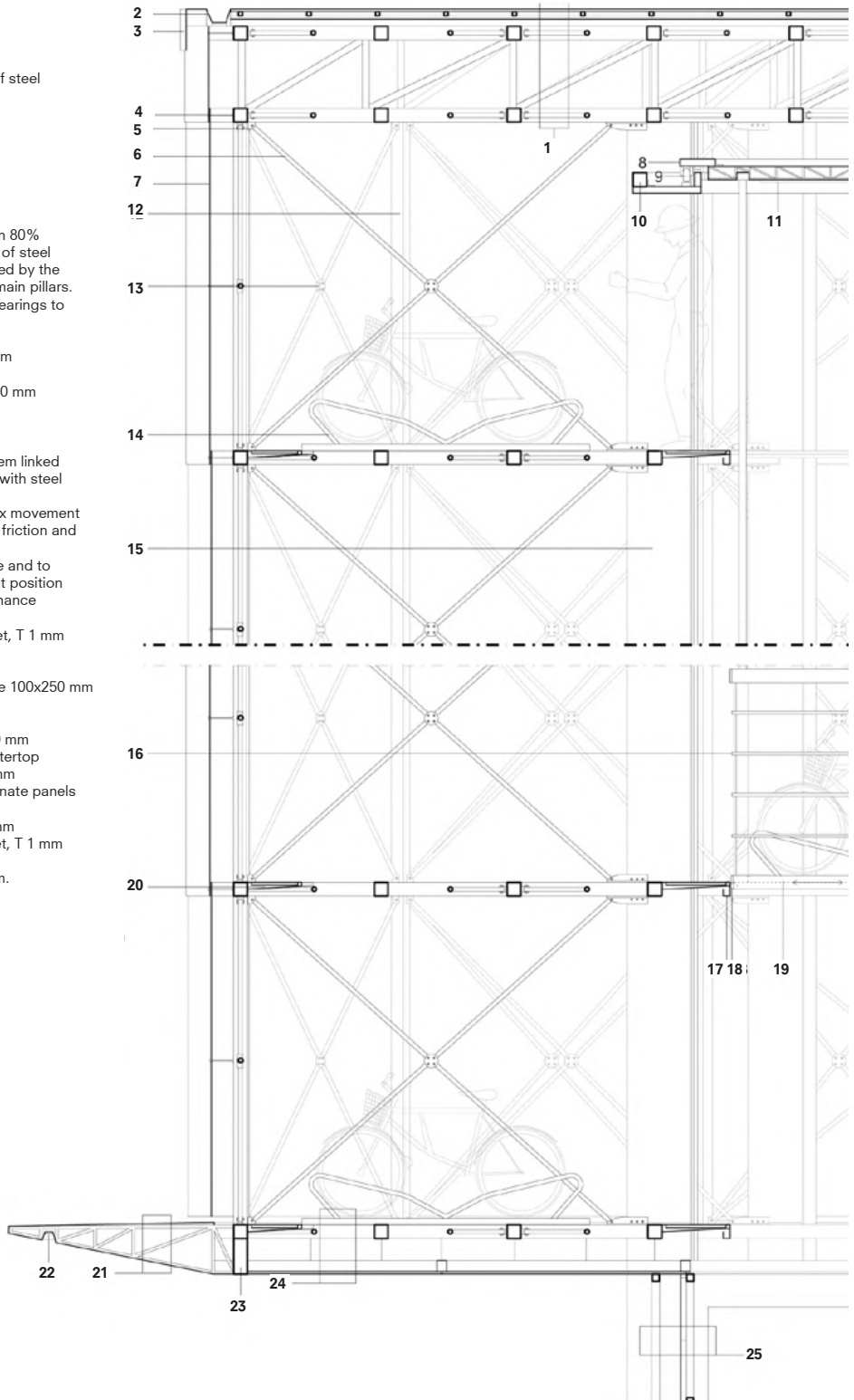

Detailed Section
 Orthographic Drawing
 Scale 1 : 50

Roof Terrace & Stairs An Amazing Machine

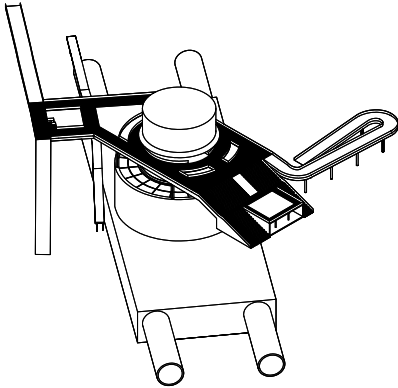

The roof is an important component of the station to give users sense of direction in the area. The uniquely designed form points users the 3 main directions to the important functional areas of De Esch, which includes the sports complex, the nature reserve as well as the future bridge connection to Southern Rotterdam and one of the most famous landmark, the Water Tower in De Esch. The roof which is connected with footbridges demonstrates the design concept of “roller coaster”. When users arrive De Esch, they will feel like they are on a roller coaster ride, they will know where they are heading, and most importantly, the journey they experience is fun and exciting. De Esch becomes an amusement park with the station as the central connection. Excitement points are laid out across the district.

On the roof, starting from the footbridges and the 2 sides of the roof are also laid with piezoelectric tiles, which generates electricity and lit up when people walk on them. These yellow belts on the ground gives clear direction to users how to travel from the footbridges to the station or to the big stairs. The tiles are also installed with wireless API sensor, which transmits data about movement behaviour in areas where the tiles are installed. This can help to create an idea of peak times for foot traffic in the station area, predict user trends, and create heat maps of popular urban spaces. The structure of the roof is made of slender concrete waffle slabs. It gives a “direction” feeling to the users when being under the roof. The grid like concrete slabs also gives interesting light and shadow effect with the skylight above. In turn, pedestrians on the roof are able to view the structure from above from the skylights.

The stairs in the design proposal provides several functions to the station. Firstly, it provides a public space. People can relax and gather at the stairs. The dance floor on the big stairs is fitted with the same piezoelectric tiles. People can dance on them while also enjoying drinks from the bar/cafe below the stairs. The bar/cafe provides good views to the park during daytime. Secondly, it activates the park which is in front of the station. The park is under-used at the moment, we hope the design creates public spaces that facilitate synergies, multi-use and attractive meeting places. It should be inviting and inspiring and build further on De Esch’s identity. The stairs together with the park are transformed into one big public space, where different public events are held regularly, such as weekend market, dance and musical performances, etc. Thirdly, the stairs are coated with yellow resin panels with LED light underneath, which are powered by peltier modules, illuminates during night. The strong yellow color stands out from the surrounding environment and gives users a recognizable structure, which is also one of the design aims of the station.

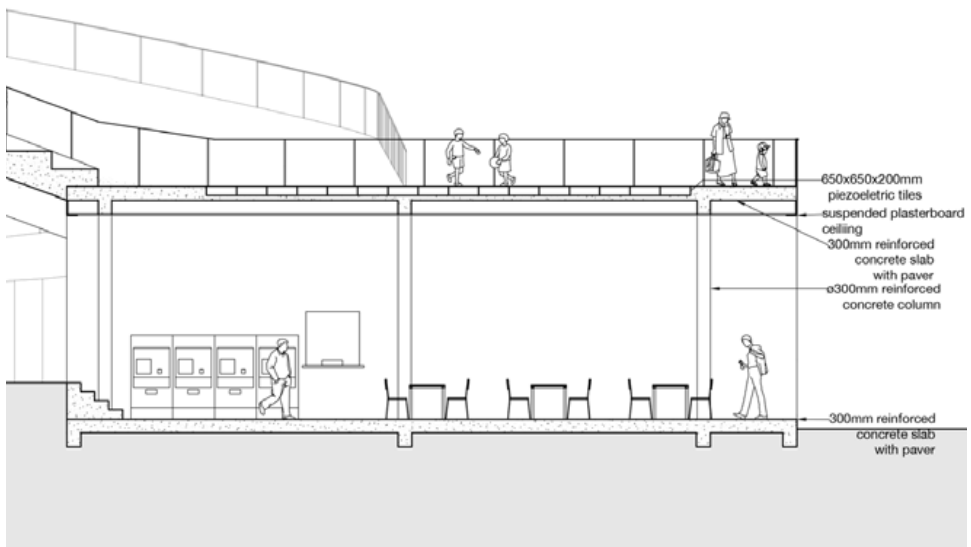
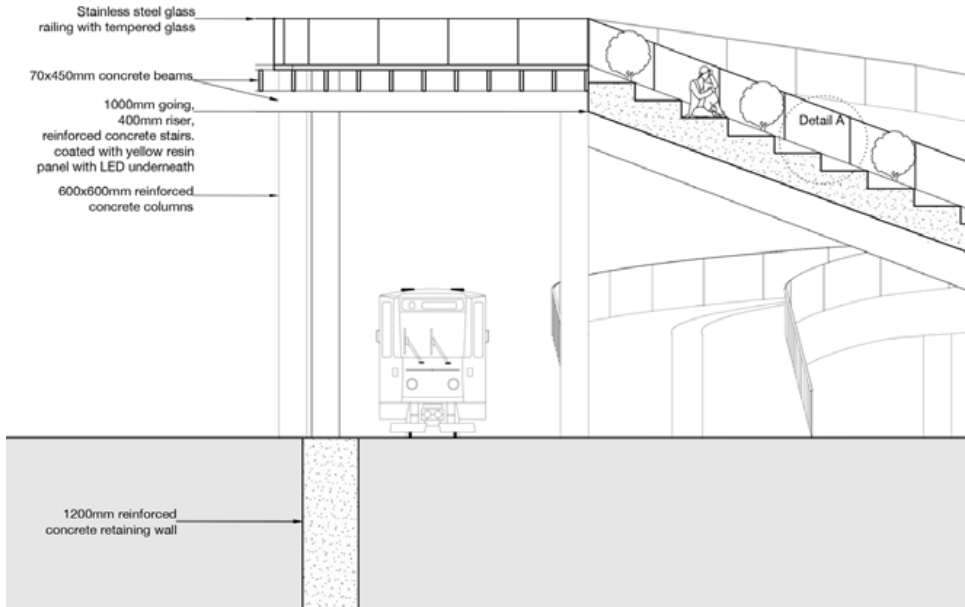

Detailed Section

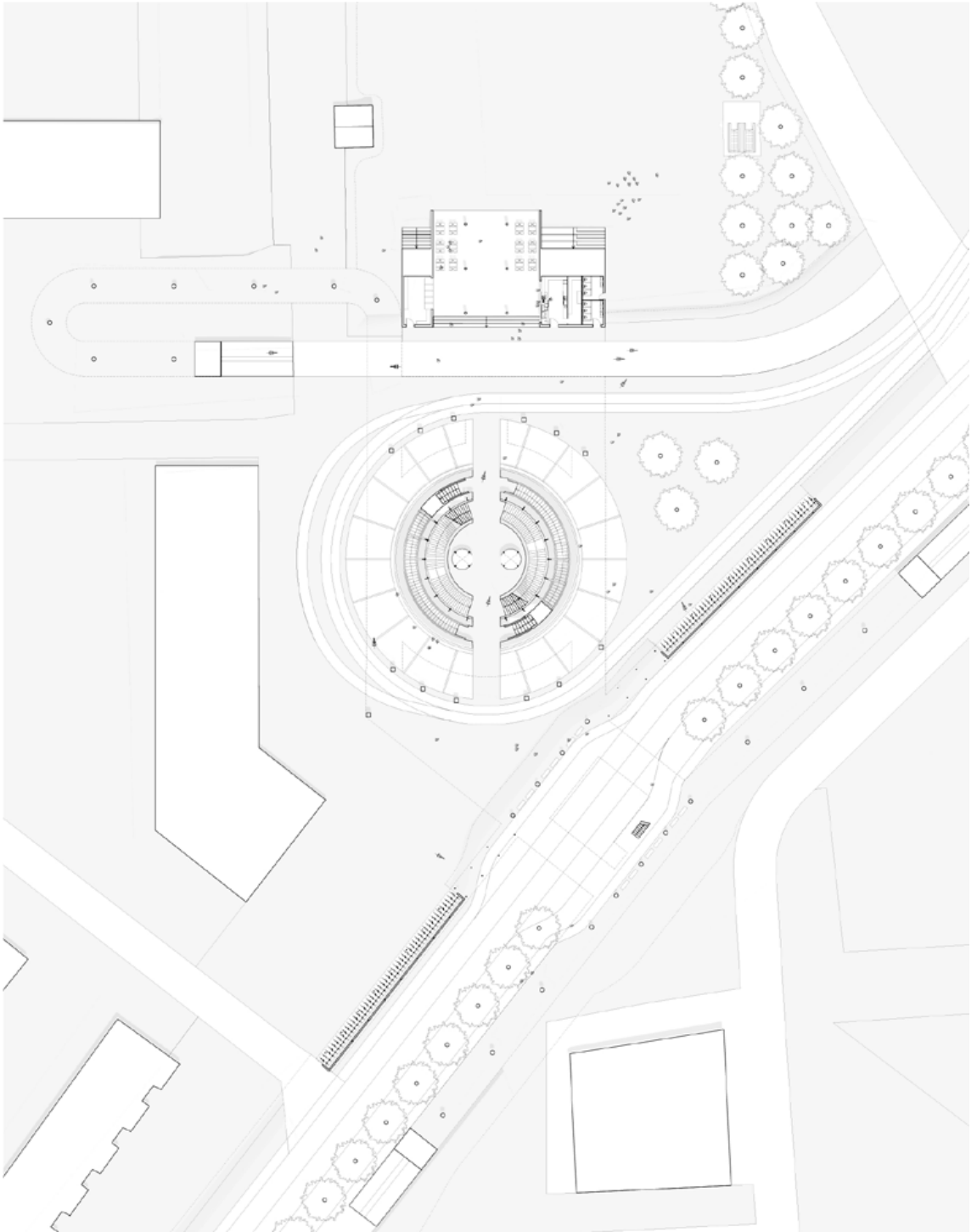

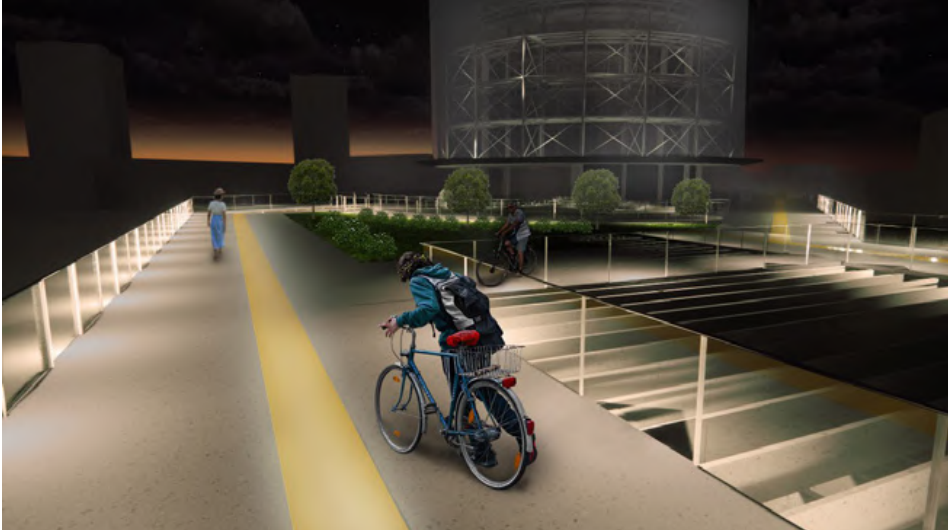

Way-finding

The two ground edges of the roof are laid with the yellow piezoelectric tiles. The tiles generate electricity and lit up as passers-by walk on them. These two yellow belts on the ground give clear direction to users how to travel from the footbridges to the station to the main stairs.



Activation of under-used area

The park is under-used at the moment and the design can create public spaces which facilitate synergies, multi-use and attractive meeting places. It should be inviting, inspiring and build further on De Esch's identity.

Social Interactions

In the daytime, the café/bar below the stairs provides excellent views to the park whilst at night, people can enjoy dancing on the dance floor, have a beverage and relax.

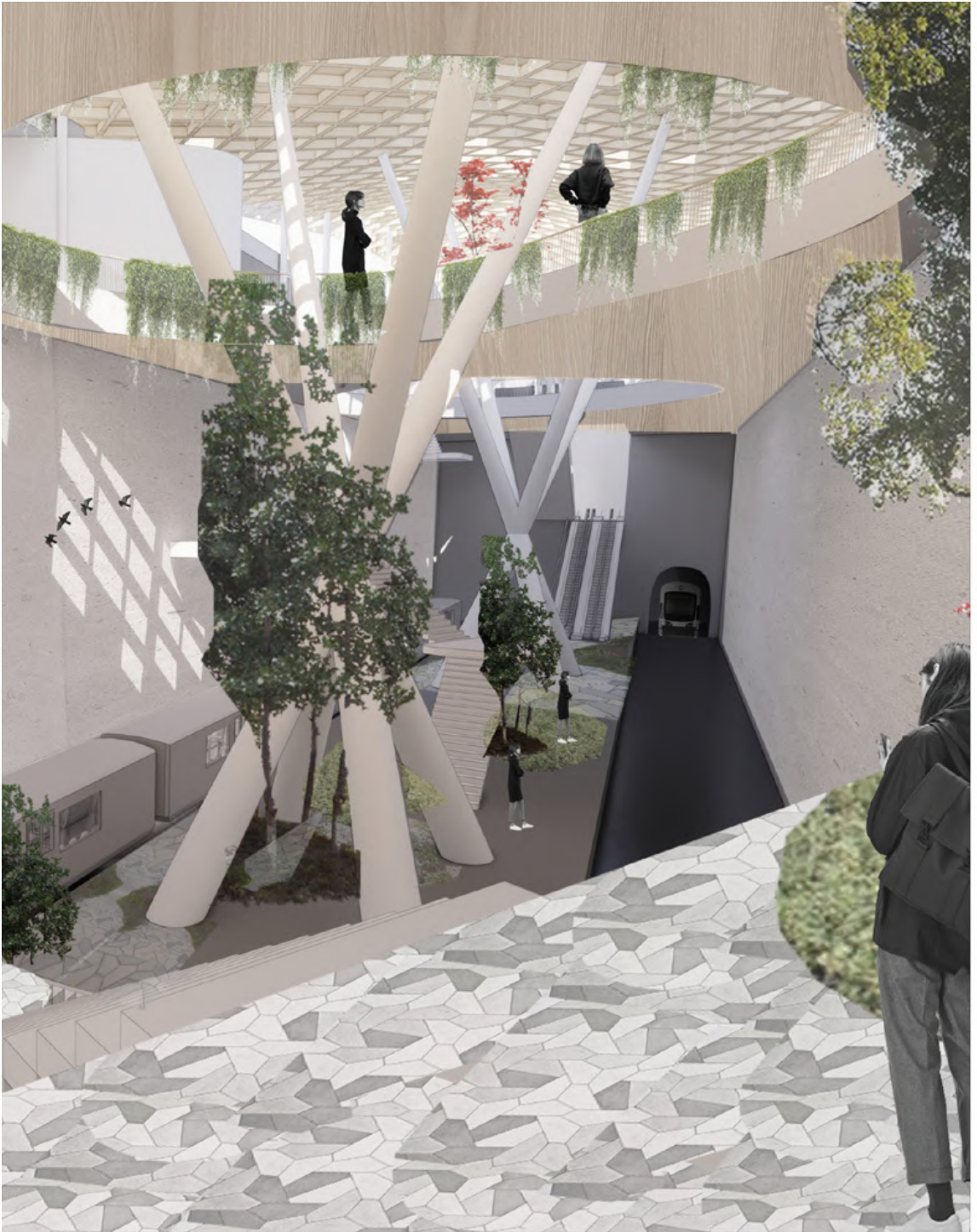

Living Station

De Esch Station
Mind the Gap!

Maya de Ridder
Julianne Guevara
Julka Veerman
Qi Hao

Narrative

Living Stations

De Esch is a calm and quiet neighbourhood with a small population of approximately 4,500. The majority of buildings in the area are residential use. An important landmark in the area is the historic water tower built in the late 19th century. It was used for the old drinking water company that previously occupied the current residential area. This water tower is an important and unique feature for the neighbourhood and adds great cultural value. Another significant aspect of the area is the lush vegetation found throughout. There are plenty of open green spaces intertwined between the residential buildings, as well as larger parks that are home to diverse plant and animal species. The neighbourhood has a strong connection to water due to its close proximity to the river, including a small beach to relax at. A strong focus towards interacting with nature and the outdoors is also felt with the abundance of sports fields and allotment gardens for personal agriculture. Thus, the neighbourhood is a nature oriented hub for city dwellers and locals alike.

The location of the station for the introduction of the new Rotterdam metro circle line system in De Esch is along Nesserdijk road, south east from the tram terminus. This point borders two distinct environments: the built context and the natural context. To the north of this location are residential, commercial, and institutional buildings, and to the south are the expansive nature reserve and the river. Through this metro station, we can bridge the gap between the two contrasting elements and connect the public to both. The metro station will have a strong ecological integration to allow a greater interaction with nature, since this is one of the few remaining significant green spaces in the city. With the densification of the neighbourhood projected for the coming years, a metro station with minimal obstruction to the exterior environment will maintain the calm atmosphere, allowing De Esch to be preserved as a sacred part of the city where one can retreat from urban life. In addition, the future planned revitalization of De Esch as a Tidal Park by the city of Rotterdam will greatly improve the quality of the natural areas, and so the station should be more focused on integrating with that aspect.

When designing a metro station we ask ourselves, what is a metro station exactly? Simply it's a point where people board a train. A place experienced only in passing where people move through it, swiftly in and out. If there is any retail component it is experienced in the same way, stopping quickly to buy a coffee or magazine and then leaving. But what if a metro station is more than that? In a neighbourhood such as De

Esch where time moves more slowly than at Rotterdam Central, what becomes of the metro station? We can start to think of it as a destination rather than as a through point, and the purpose is not only for the train, but the building and surrounding public space itself. The local population will use the station to leave and return for various purposes such as work, shopping, and visiting family and friends. The outer population will use the station to visit the parks and amenities unique to the area. However, both groups have the opportunity to converge in the public space. It can be a meeting place, somewhere you can spend time and sit for a while. Then focusing on the natural context, the metro station can be a place to learn and be inspired by the natural environment. Thus it becomes a living station with the possibility to take on purposes such as air purification or urban agriculture. A greenification of our infrastructure is necessary to combat the mundane commute typically experienced through the traditionally cold materiality of gravel, steel, and concrete stations.

When considering the form of the station itself, firstly there is a distinct experience with the station above ground, but in this case, lack of built form. The station will consist of two human scale entry/exit points, one oriented towards a vista of the water tower and surrounding buildings, and one towards the nature park. The surface of the metro station will be a continuation of De Esch park, an interactive green roof and public space. This gathering point is a neighbourhood node where the public can partake in bird and animal watching while having a beautiful view of the river. Besides the two entry/exit points, the majority of the metro station will be underground. The interior experience of the metro station will bring life to below. Commuters will have a connection with the outdoors while on the platform and the walkways will be lined with greenery. The two aspects of built and nature will contrast and intersect here with a play between hard and soft elements. The new metro station in De Esch will be a meditative space that brings peace to the hectic bustle that results from commuting.



Vantage Points

Concept Model
Entrances orient travellers by directing them
towards local landmarks

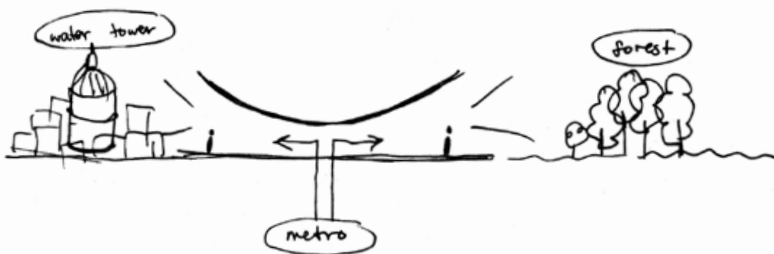

Key Concepts

1. Maintain a calm atmosphere in the Esch neighbourhood

Incorporating daylight to the underground level
Meditative, tranquil, serene space

2. Ecological integration and education

Promote biodiversity with a strong presence of nature
Diffusion of natural elements into the built realm

3. Site sensitive orientation and design

Views to local landmarks and a reflection of those in the design

4. Metro station as a public space

Creating a neighbourhood node as a connector between two sides of the site



Creating several interesting vistas

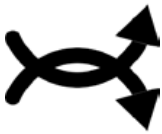

Creating an intertwined design within Built and Nature



Get in touch with the nature



Sport facilities, integrated in the design of the roof



Relaxing



A new route through Rotterdam

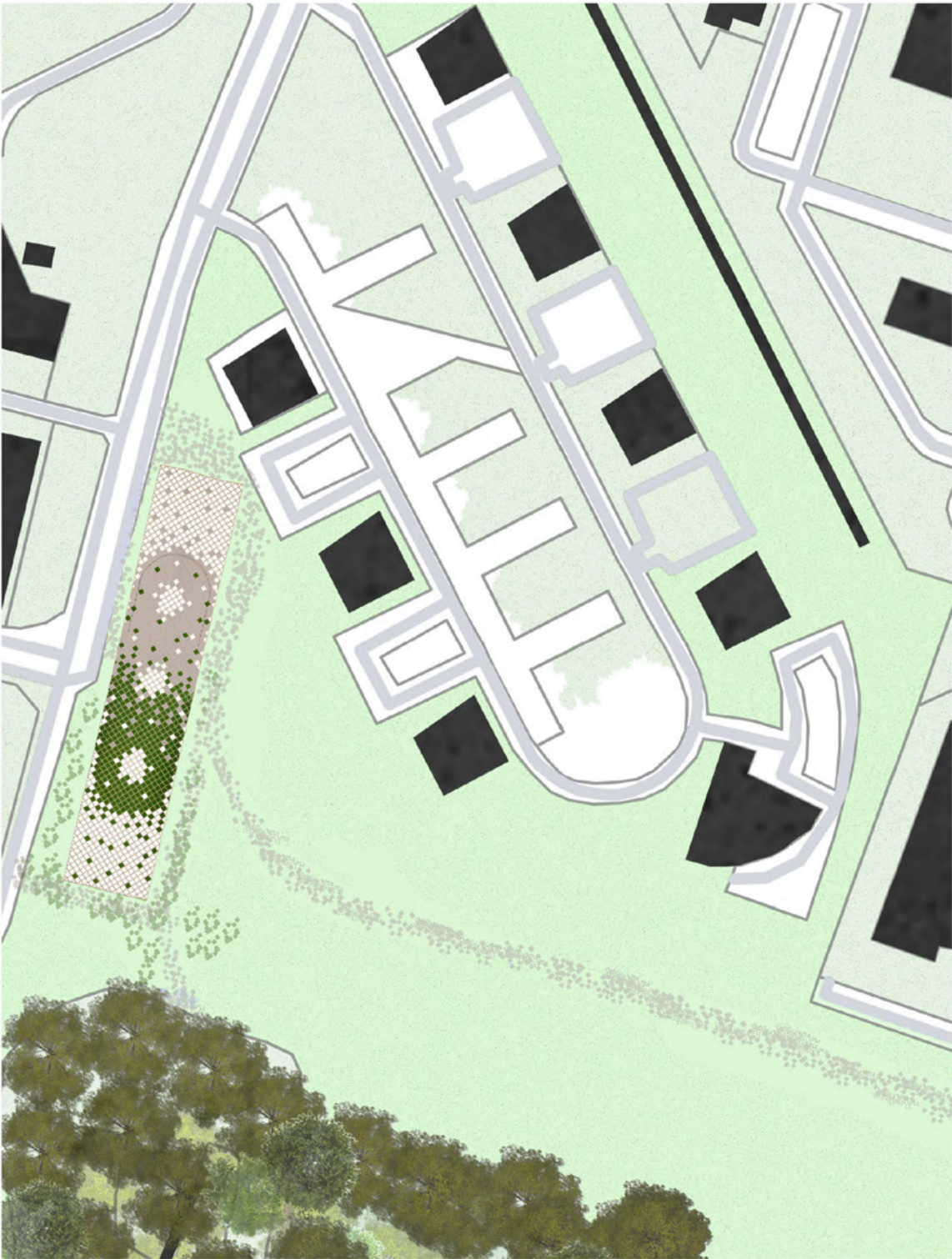

Gradual Transitions Urban Square & Roof Design

The entire design of the new metro station is about a gradual transition between the built environment and the nature. Especially through in the interior we want to reflect on what happens above, outside. The metro station should lead the passengers and visitors organically from one part to the other.

To achieve a gradual transition, the programme of the plaza at -1 is based on the difference between built land and natural land.

The facilities belong to the built part. Open and green waiting, relax spaces belong to the nature part.

Therefore, the closer one gets to the built part, the more facilities there are and the closer to each other they are.

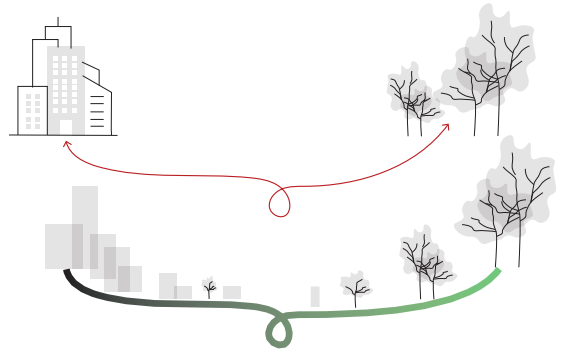

Roof Concept Grid



Green Sections of the Roof

Concrete Sections of the Roof

Glazed Sections of the Roof

Roof's Wooden Grid Structure

Visualisations of Combined Elements

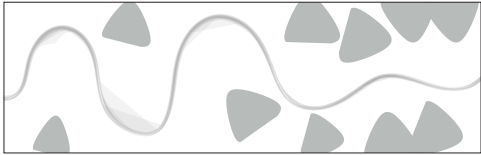

Facilities

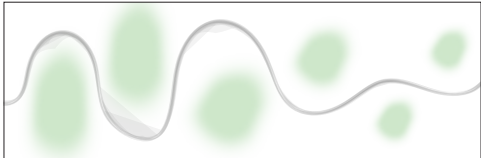

Green Areas

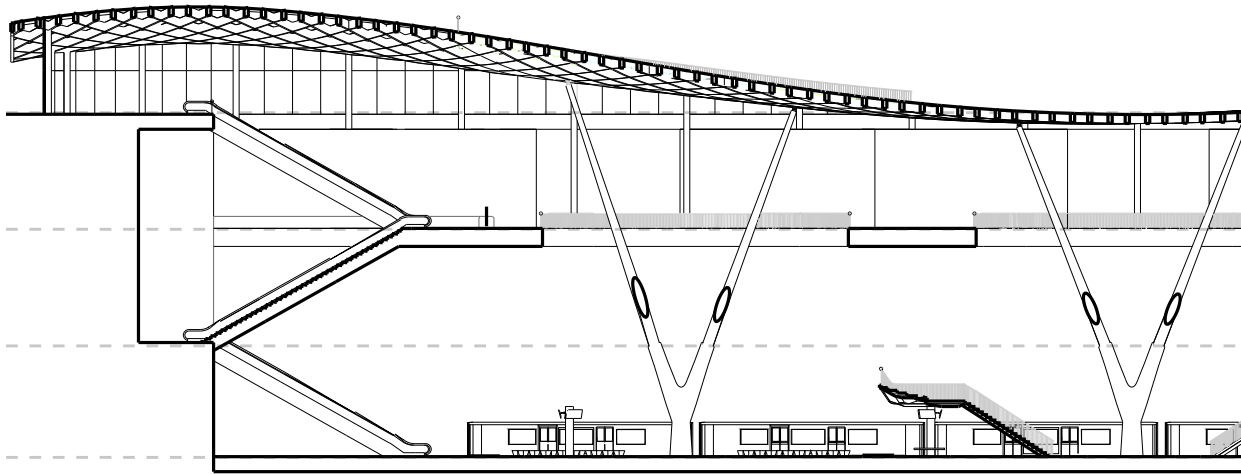

Section

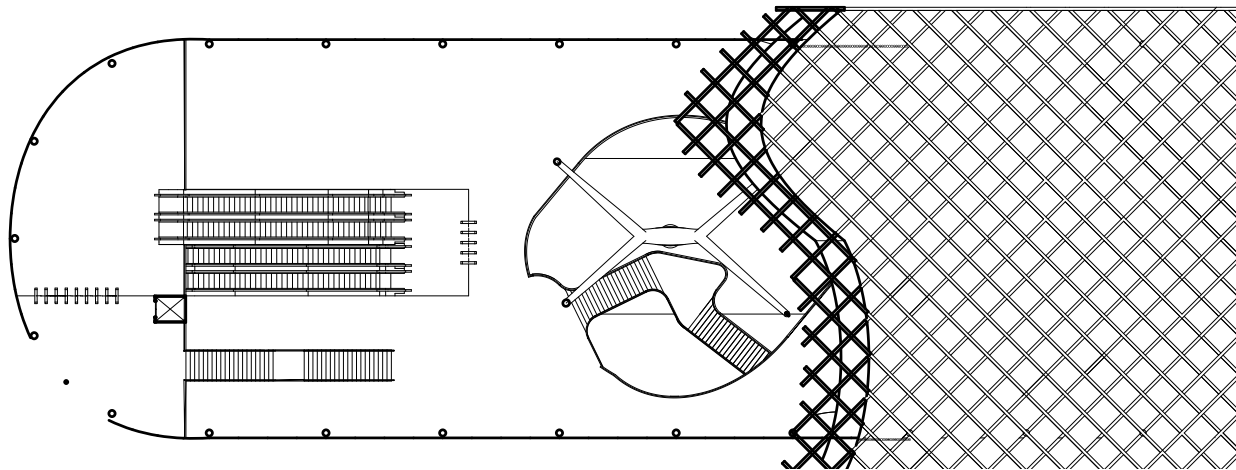

Ground Level Plan

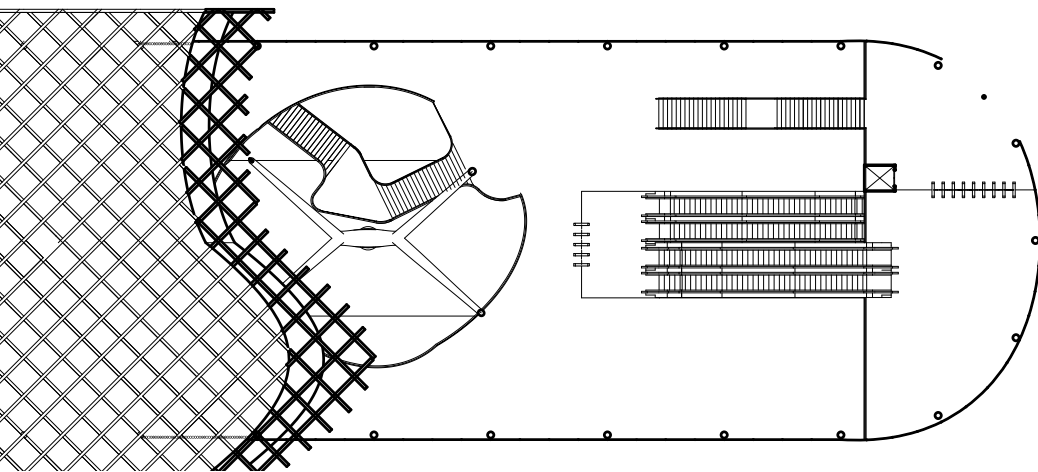
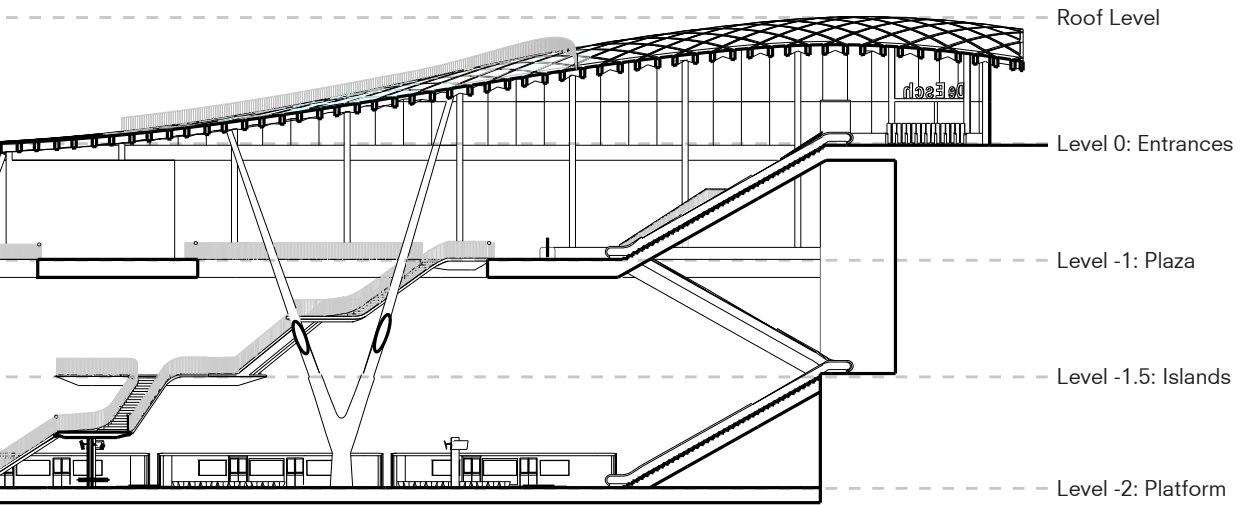

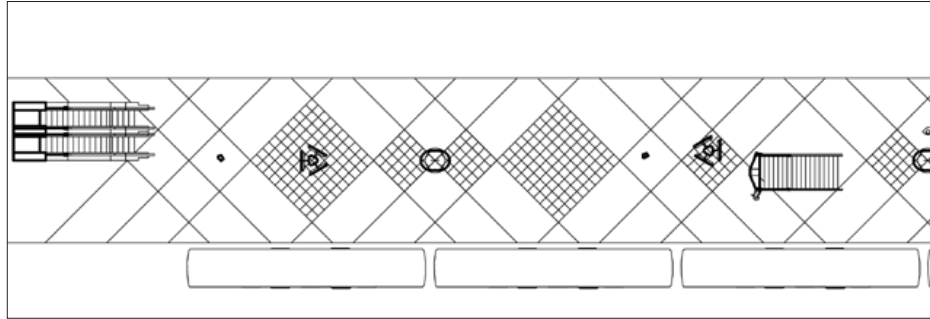

-1 Level Floor Plan

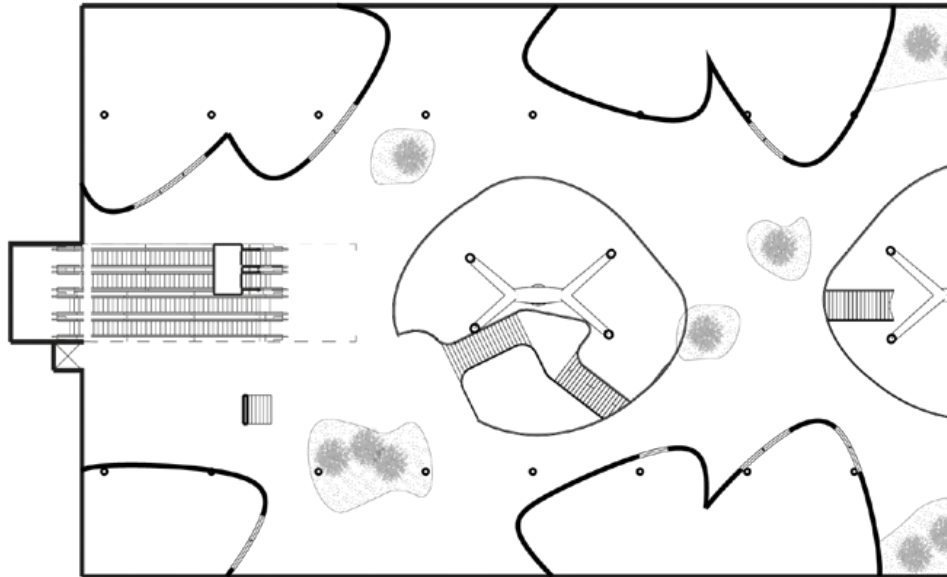

Platform Level Floor Plan

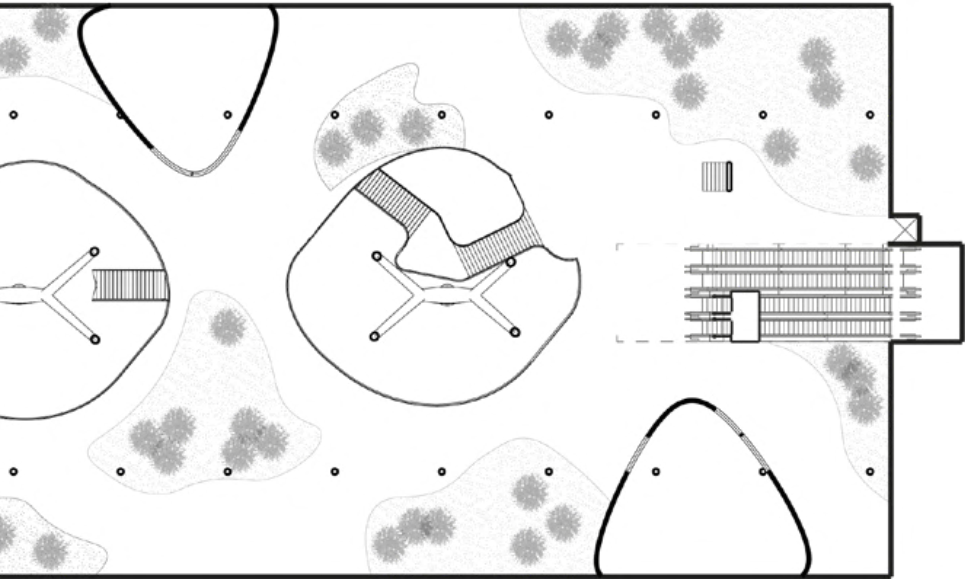
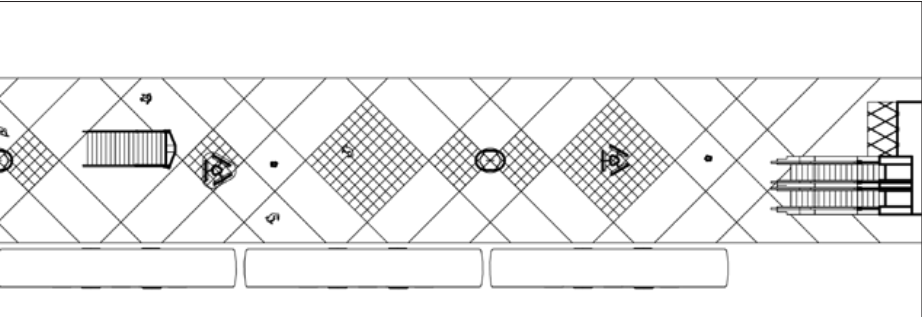

Architectonic Concepts

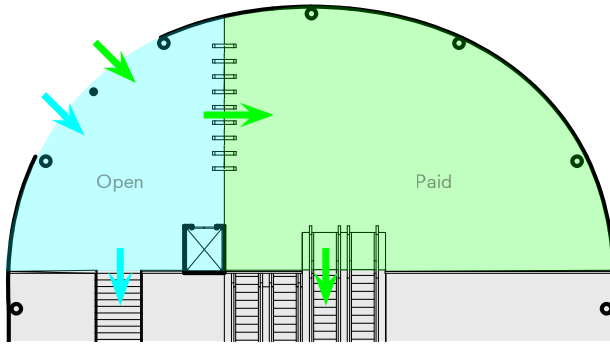

Paid vs Open

Easy access to either commercial or train with separated flows

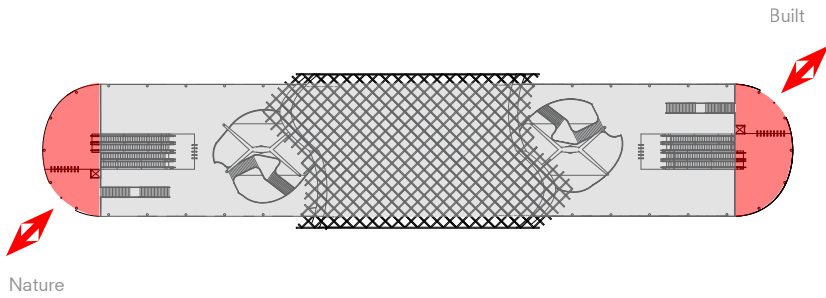

Minimal Footprint

Entrances do not significantly take up space, giving more to public activity above and below the roof

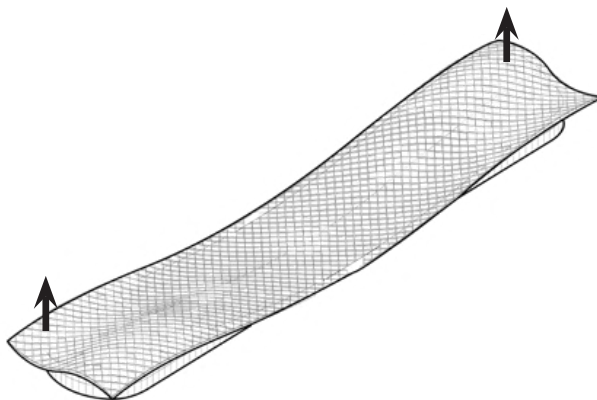

Opens Up at Entrance

Roof shape flows open to invite travellers in at entrances



Gradual Transition
Illustration



View of roof opening towards vantage point
(built/nature) at exit.
Illustration



Island Hopping
Illustration

Lighting Design

Light Gaps

The aim is to provide the station with optimal daylight at all levels.

Therefore, on the -1 plaza, openings were designed. These gaps provide the platform with daylight in order for trees and other flora to grow.

The openings also have other functions as they will be used for the circulation: stairs, elevators and escalators.

Furthermore, the placement of the openings will influence the routing and experience of the -1 plaza level and its users.

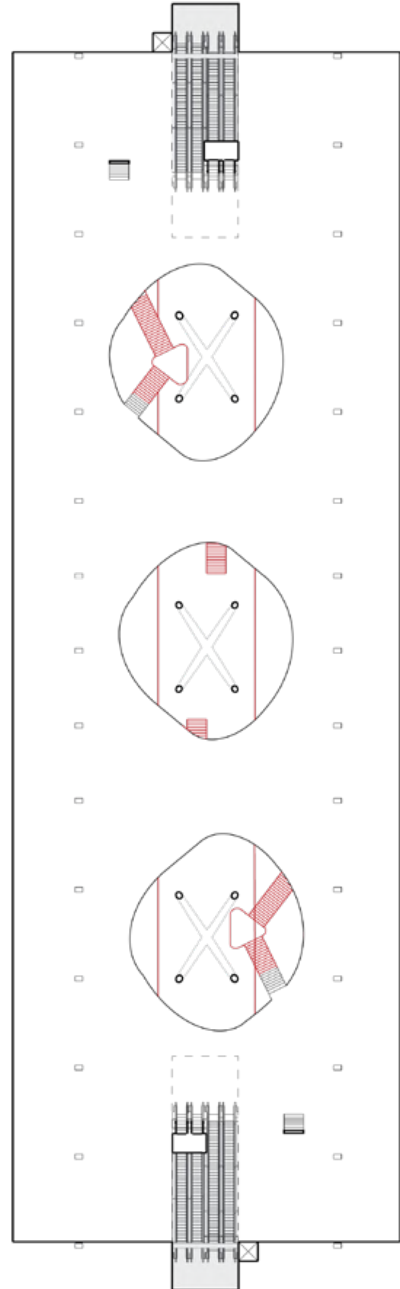
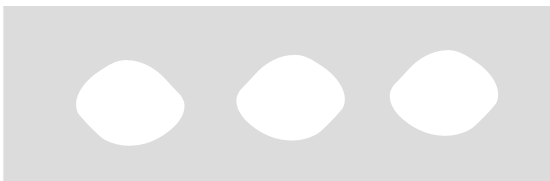
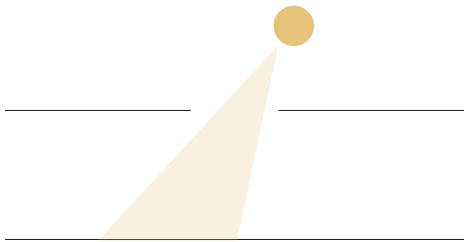

Public/Private Sphere Routes & Accessibility

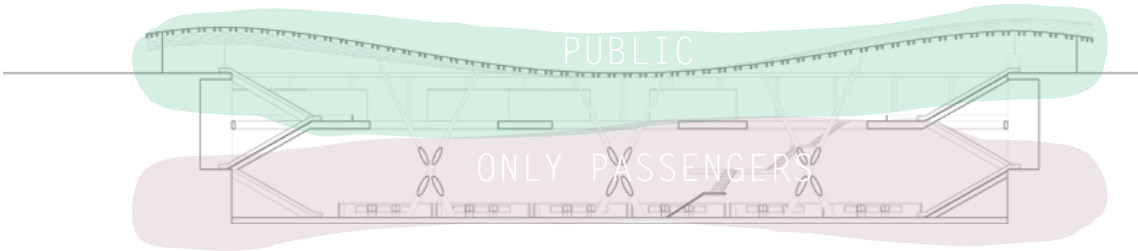

Accessibility

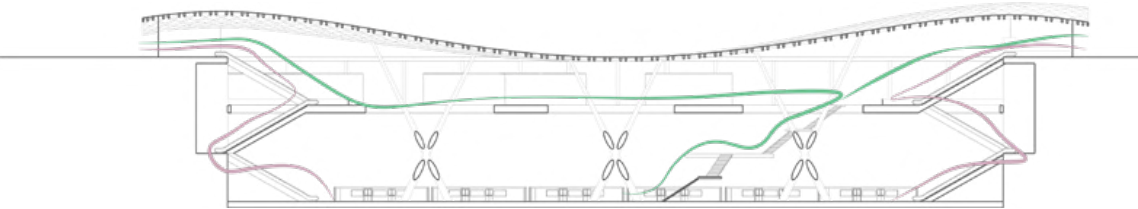

Quick Route: for passengers in a hurry.
Long Route: for everyone, visitors and passengers.

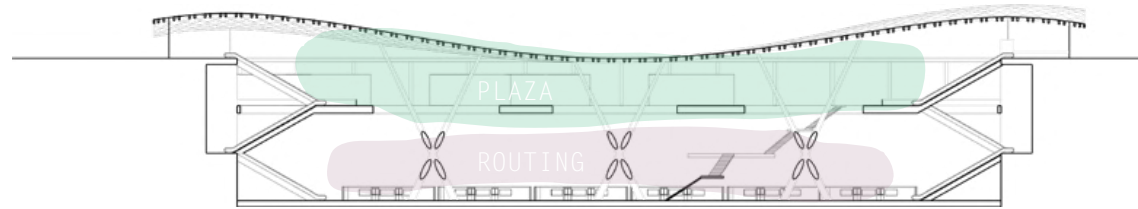

Two Levels of Public Spaces: Square & Route

- 1. Square above the station:
This could be a platform and meeting point.
- 2. Inside route from the built atmosphere to the ecological/natural atmosphere.

Structural Design
Building Technology

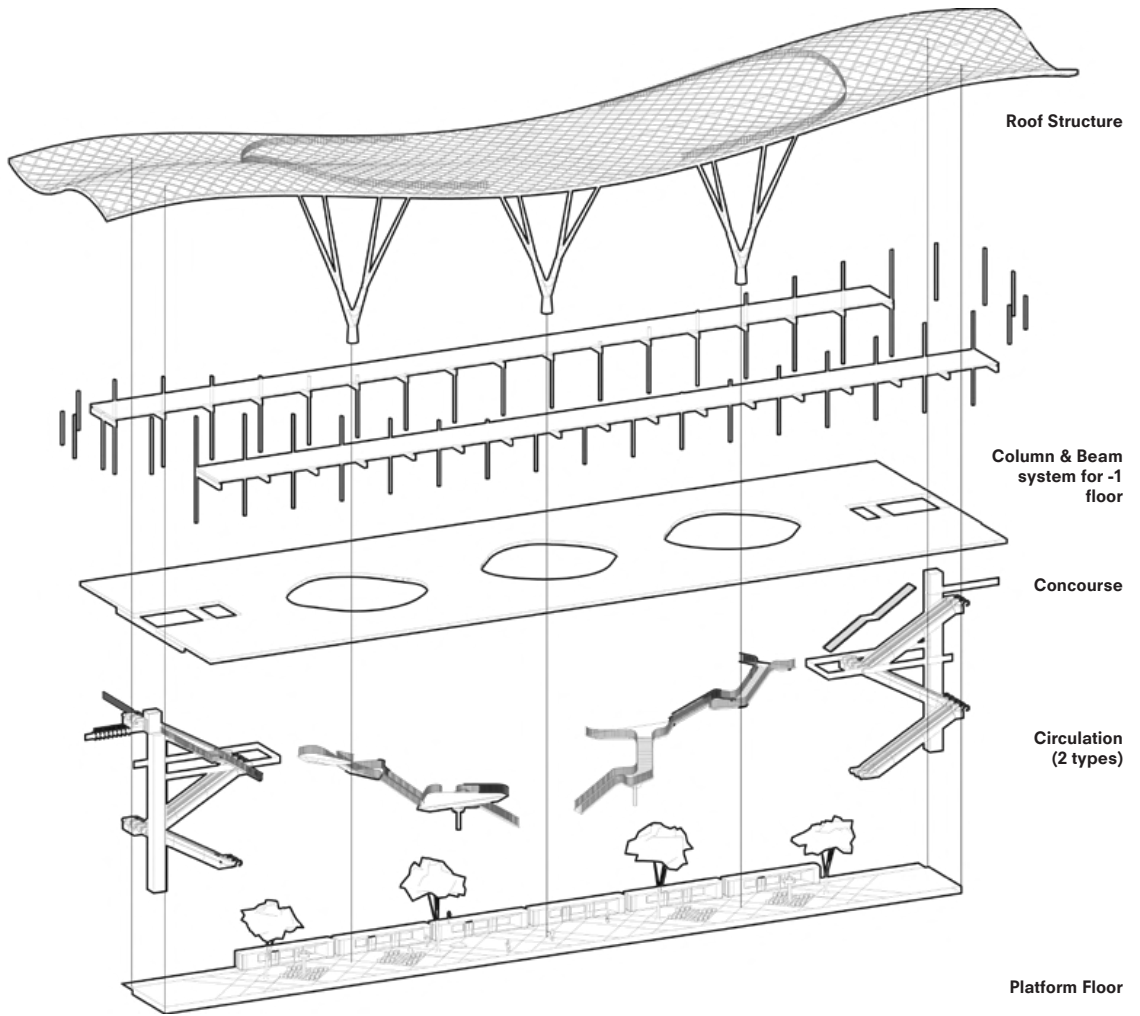

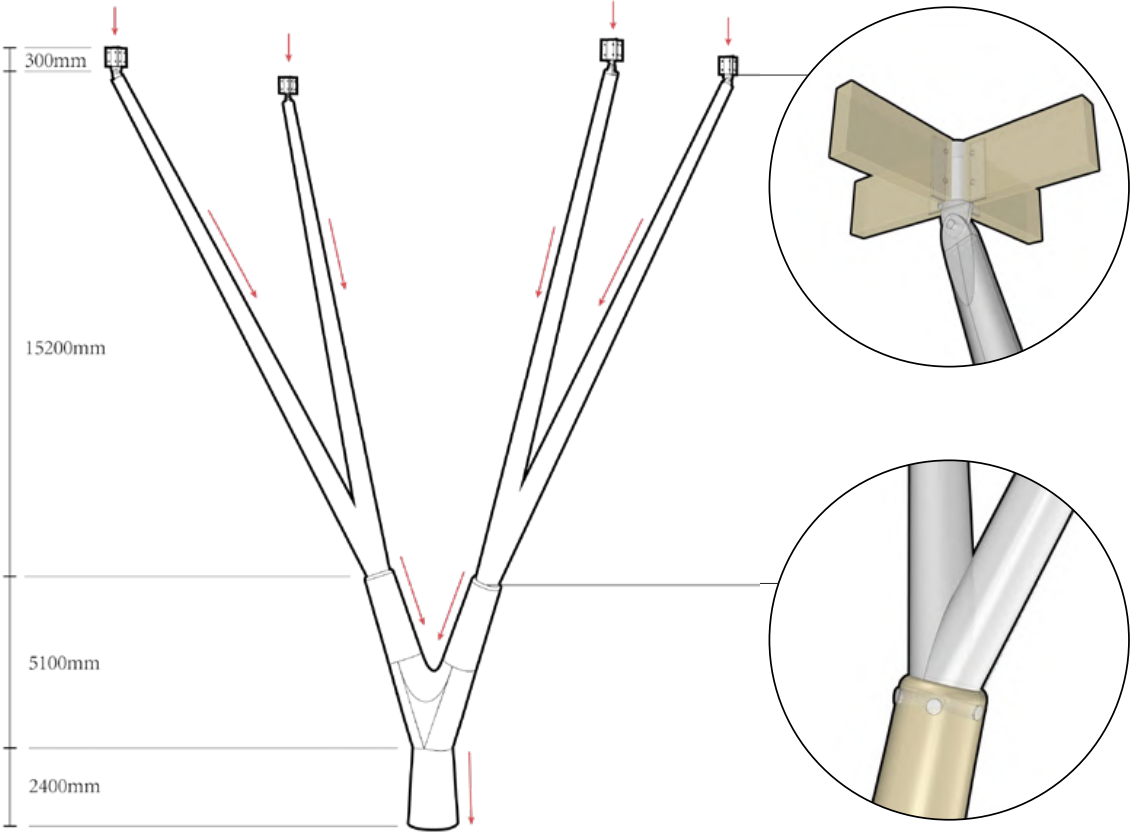

Roof Structure

Building Technology

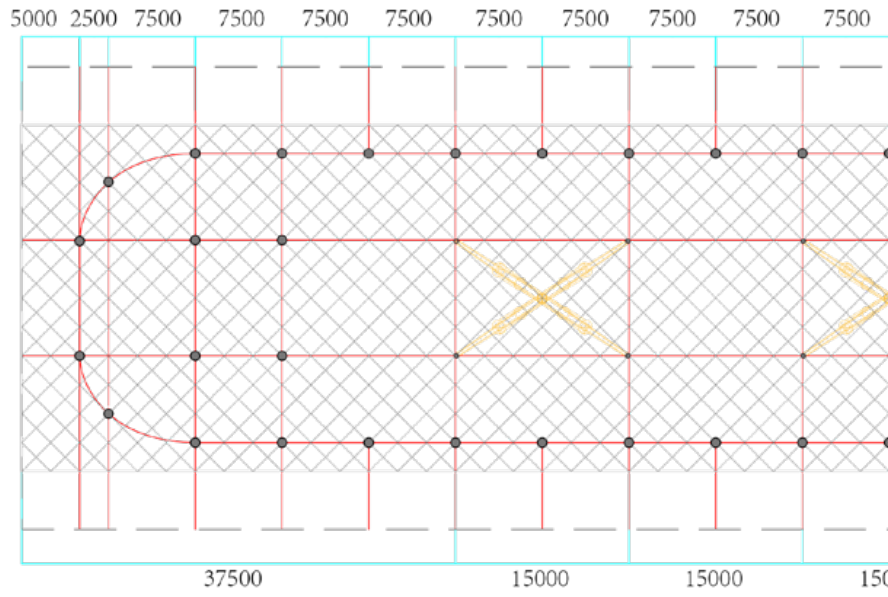

Roof's Structural Grid Plan

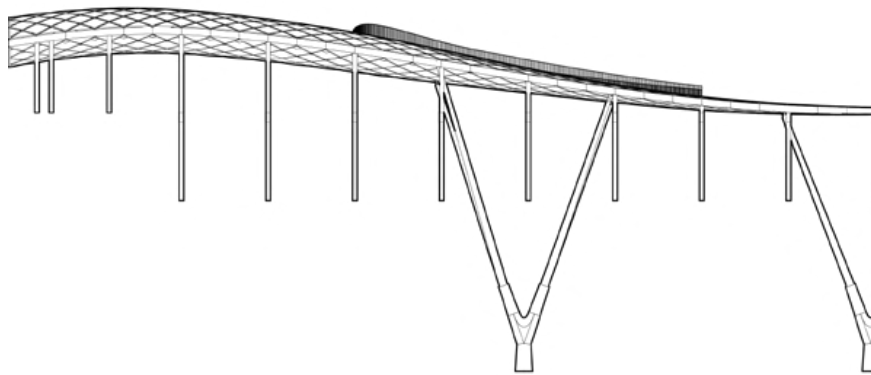

Elevation of Roof Structure

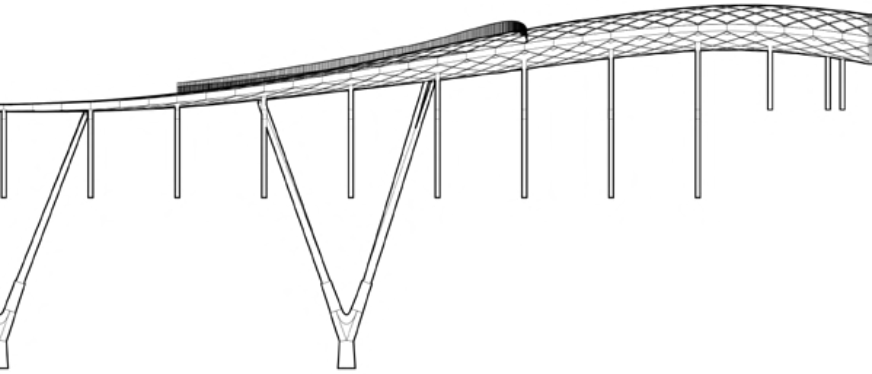
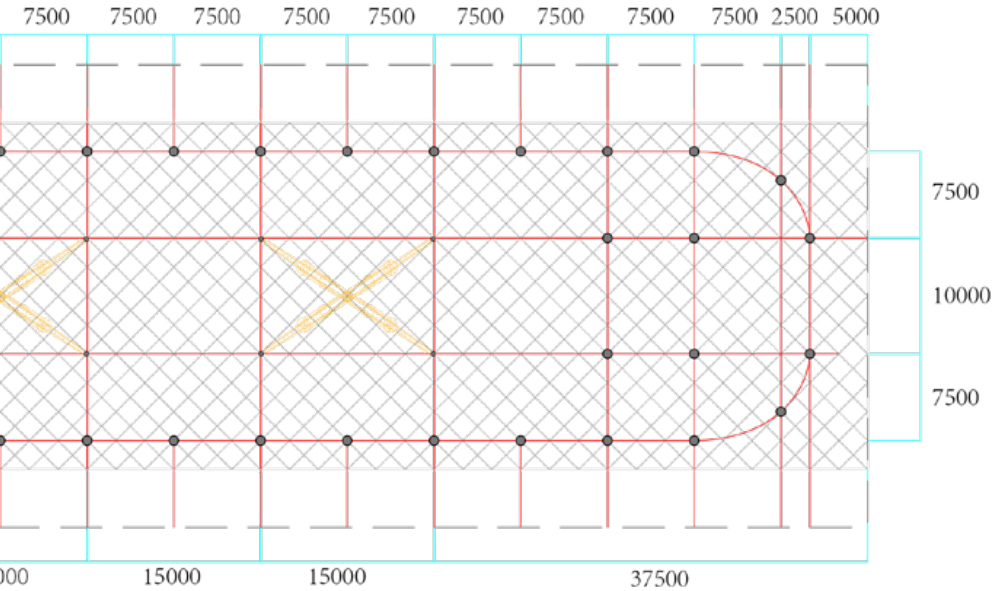



R

ROTTERDAM ZUID

Collective Research Location & Characteristics	313
Conceptual Scenarios Visions	325
Node Value! Feyenoord	327
Place Value! Connecting the fragments	246

Giannis Nikiforou
Jemina Lai
Laura Sacchetti
Rogier Tamminga
Diego Toribio Álvarez
Gerjan Agterhuis
Su Gu

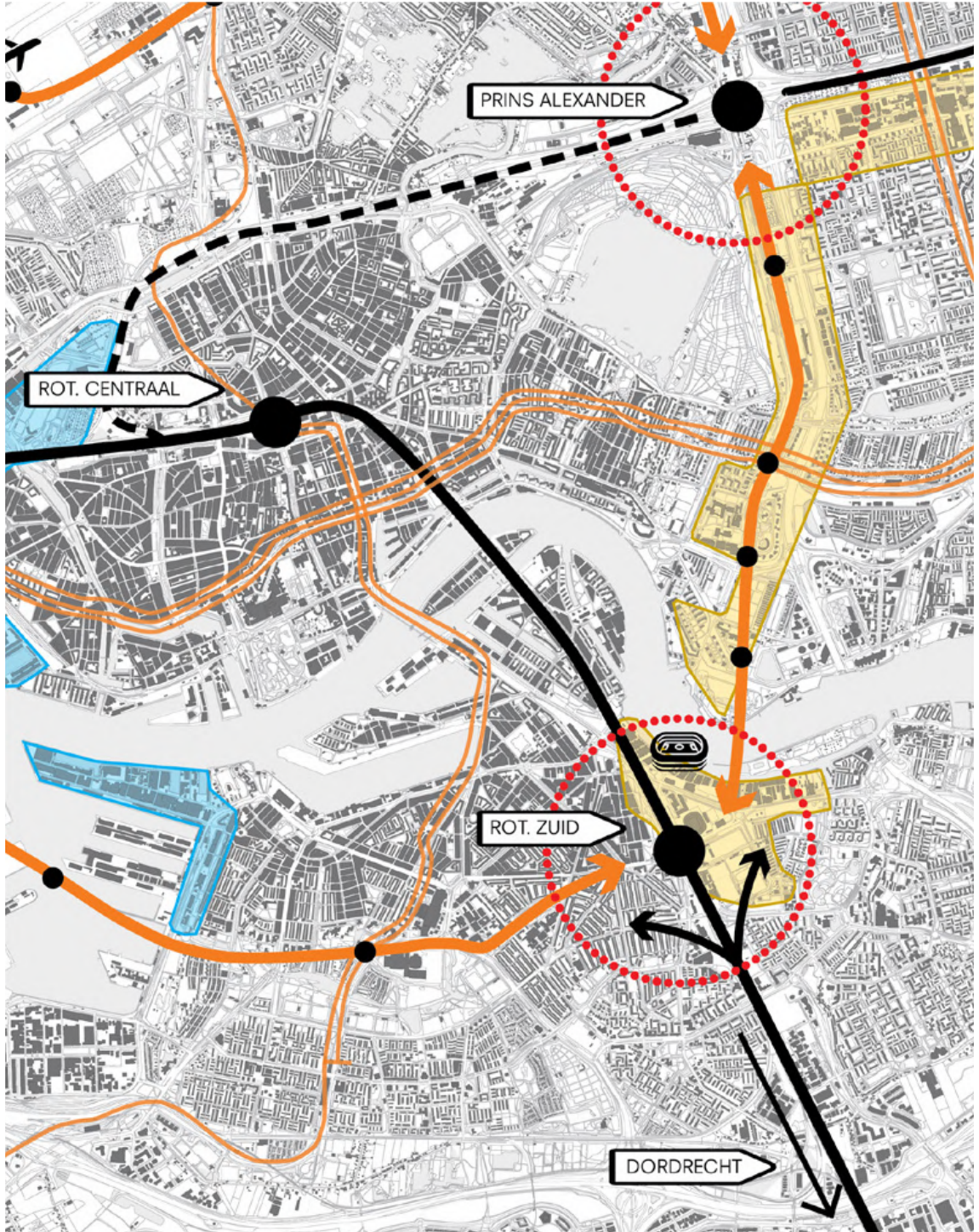

Importance of the new Station in Rotterdam's future urban context



1881



1938



1981



2012

Photo-Documentation





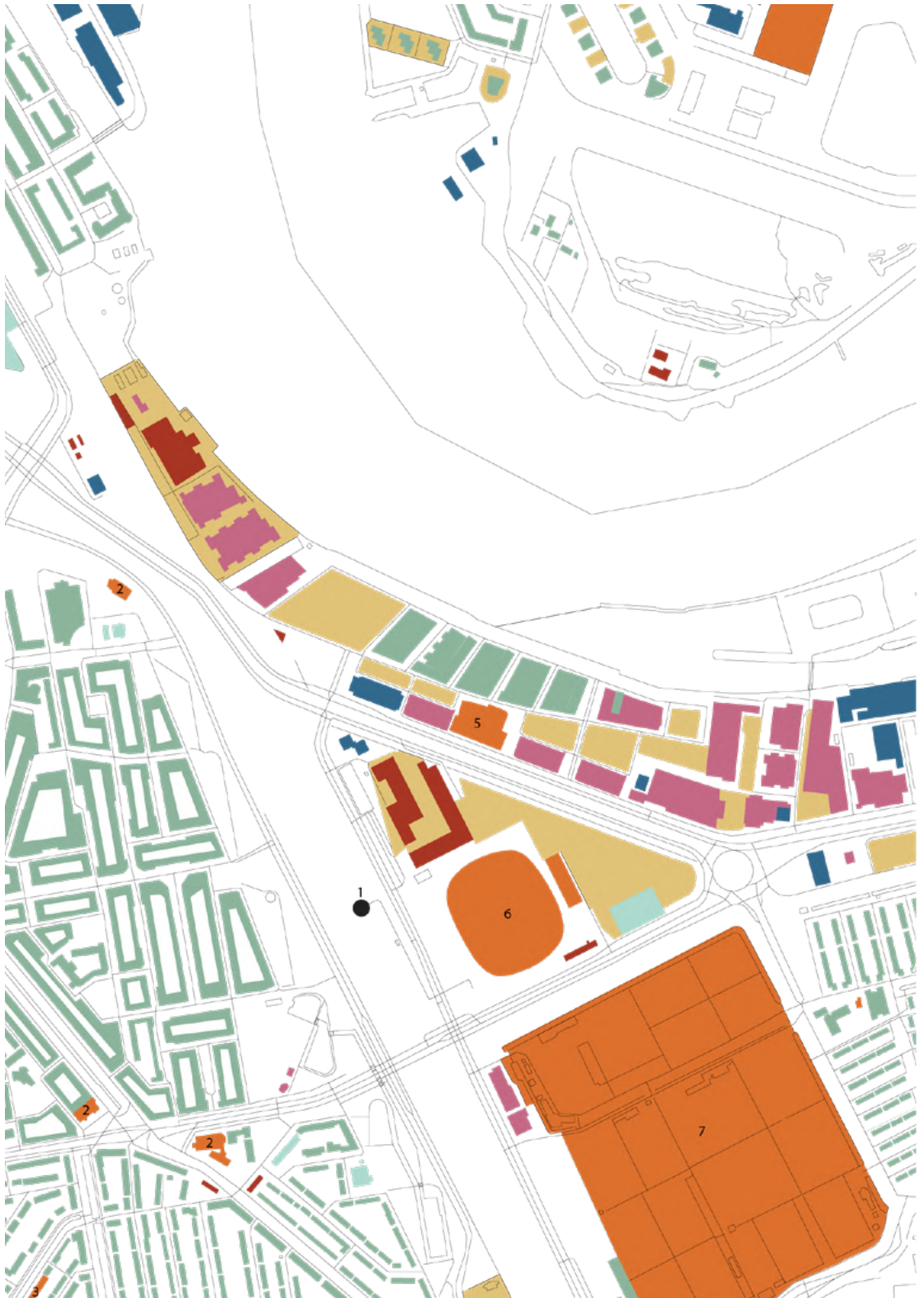

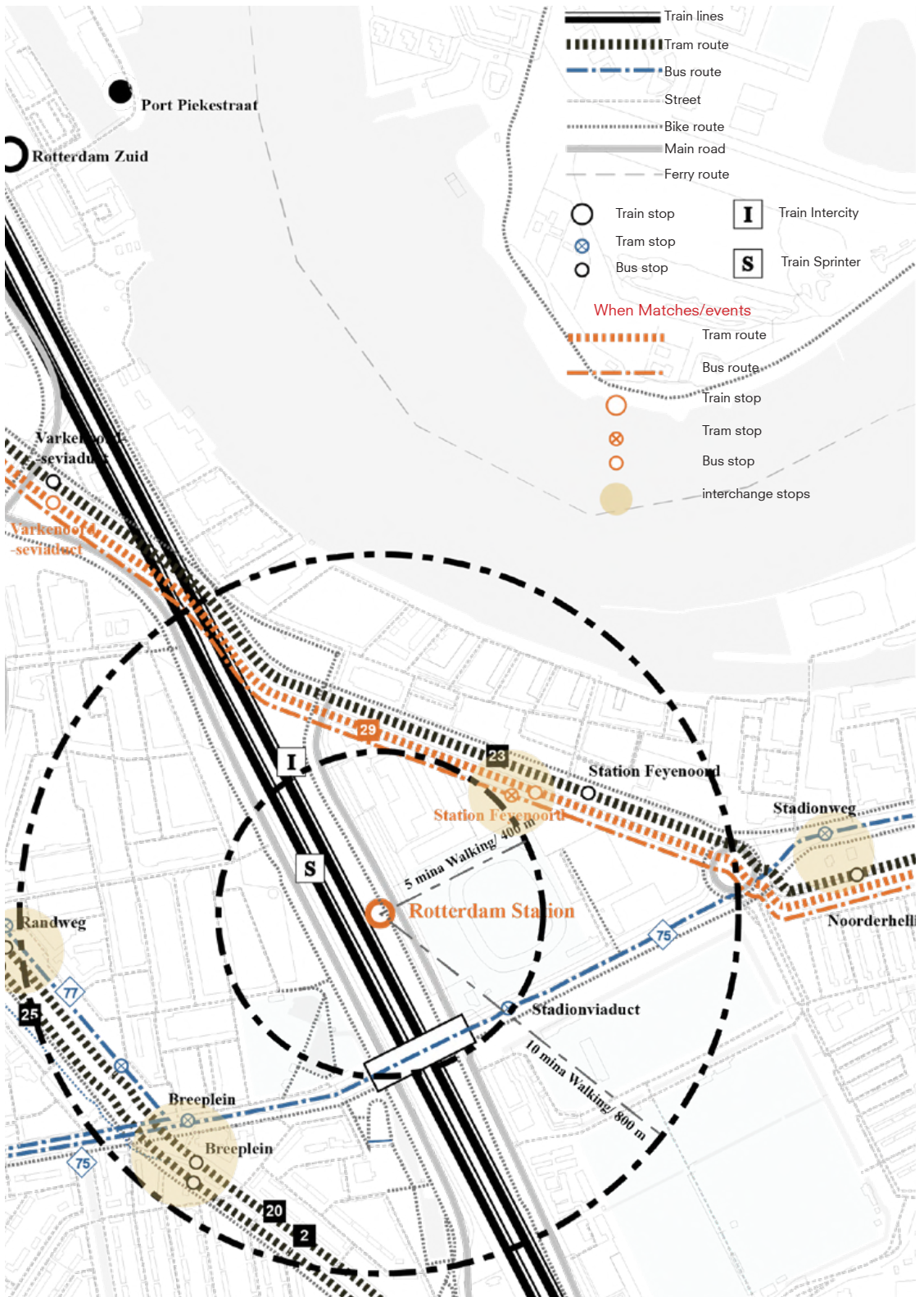

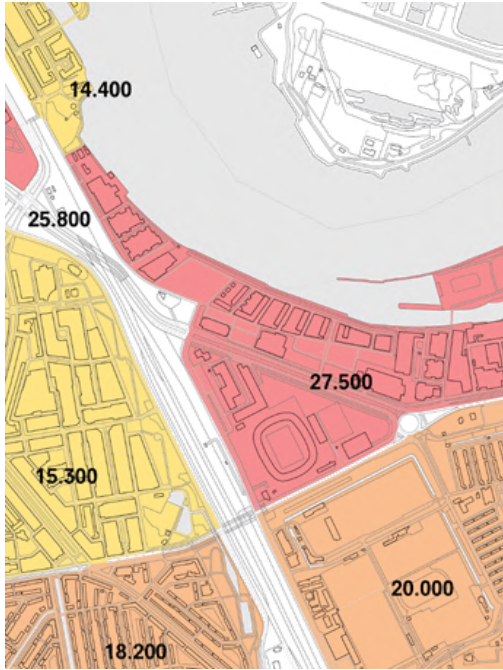

Average Income
Date - 26/02/2020
Source - www.allecijfers.nl

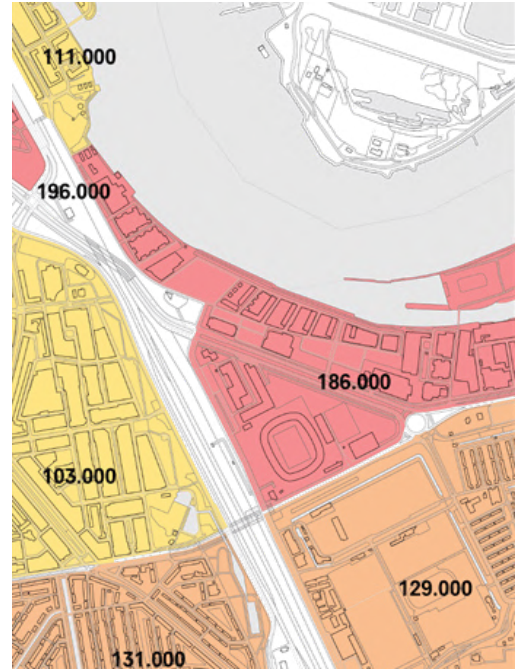

Average Dwelling Value
Date - 26/02/2020
Source - www.allecijfers.nl

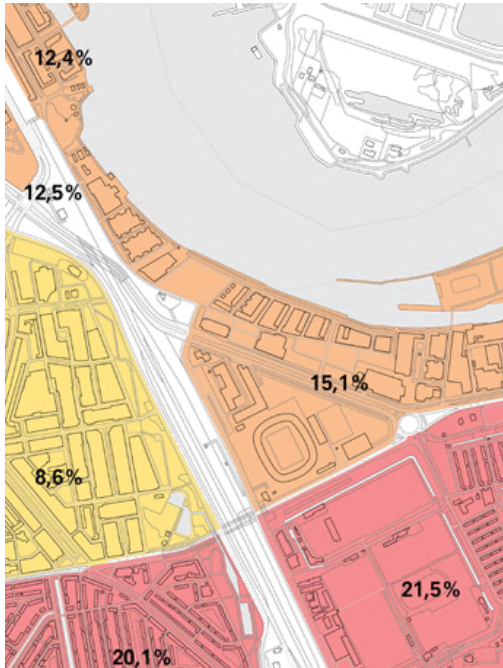

Elderly population (%)
Date - 26/02/2020
Source - www.allecijfers.nl

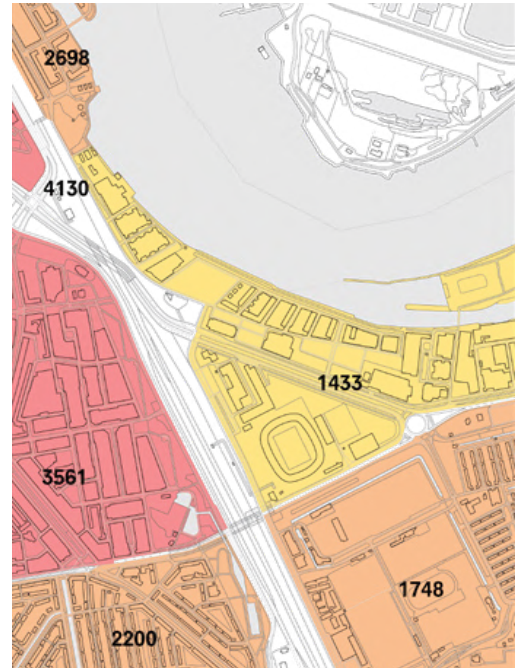

Volume of Cars
Date - 26/02/2020
Source - www.allecijfers.nl

Spatial Data
Shadow Analysis

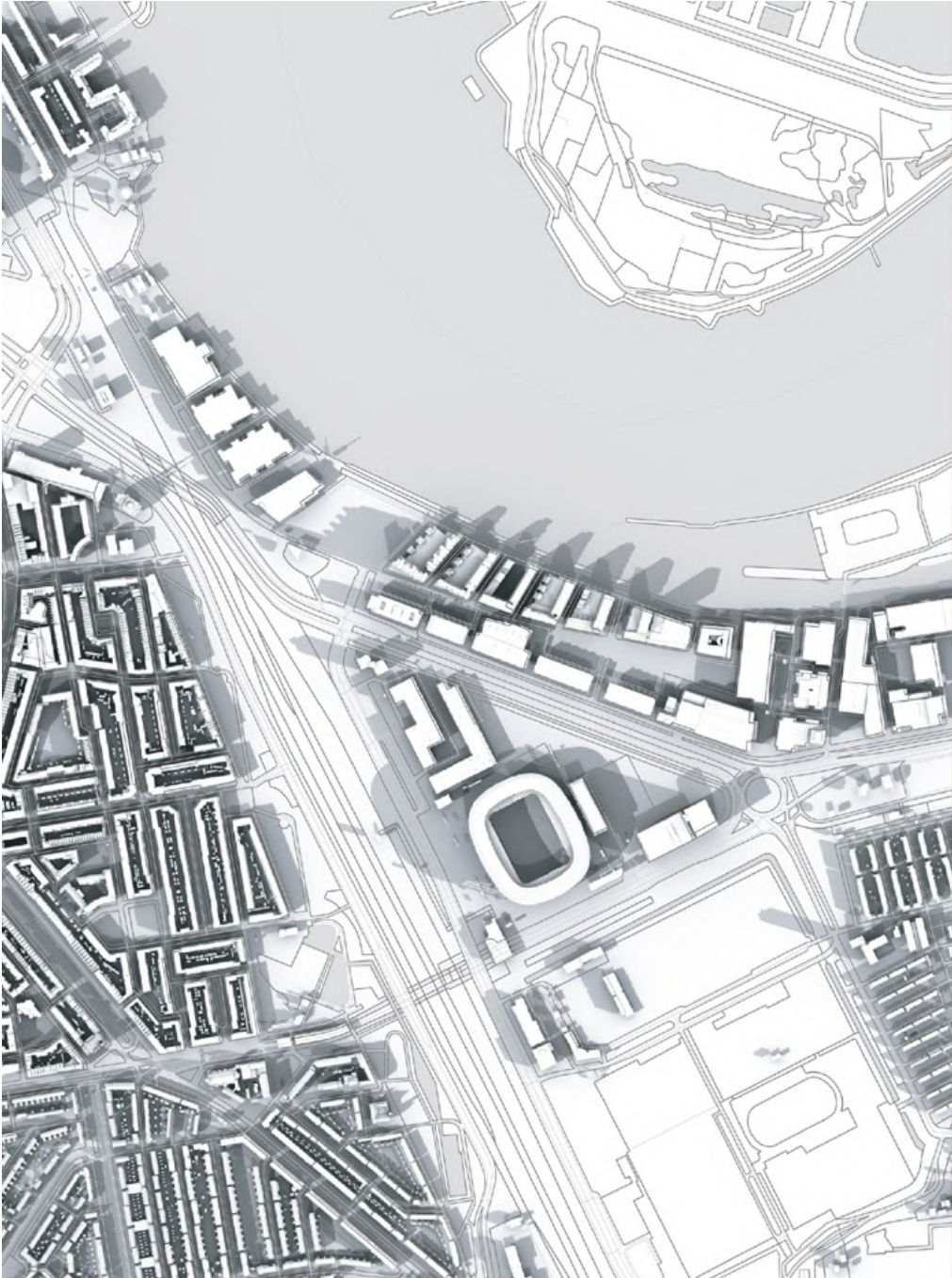

Shadow Cast analysis for September

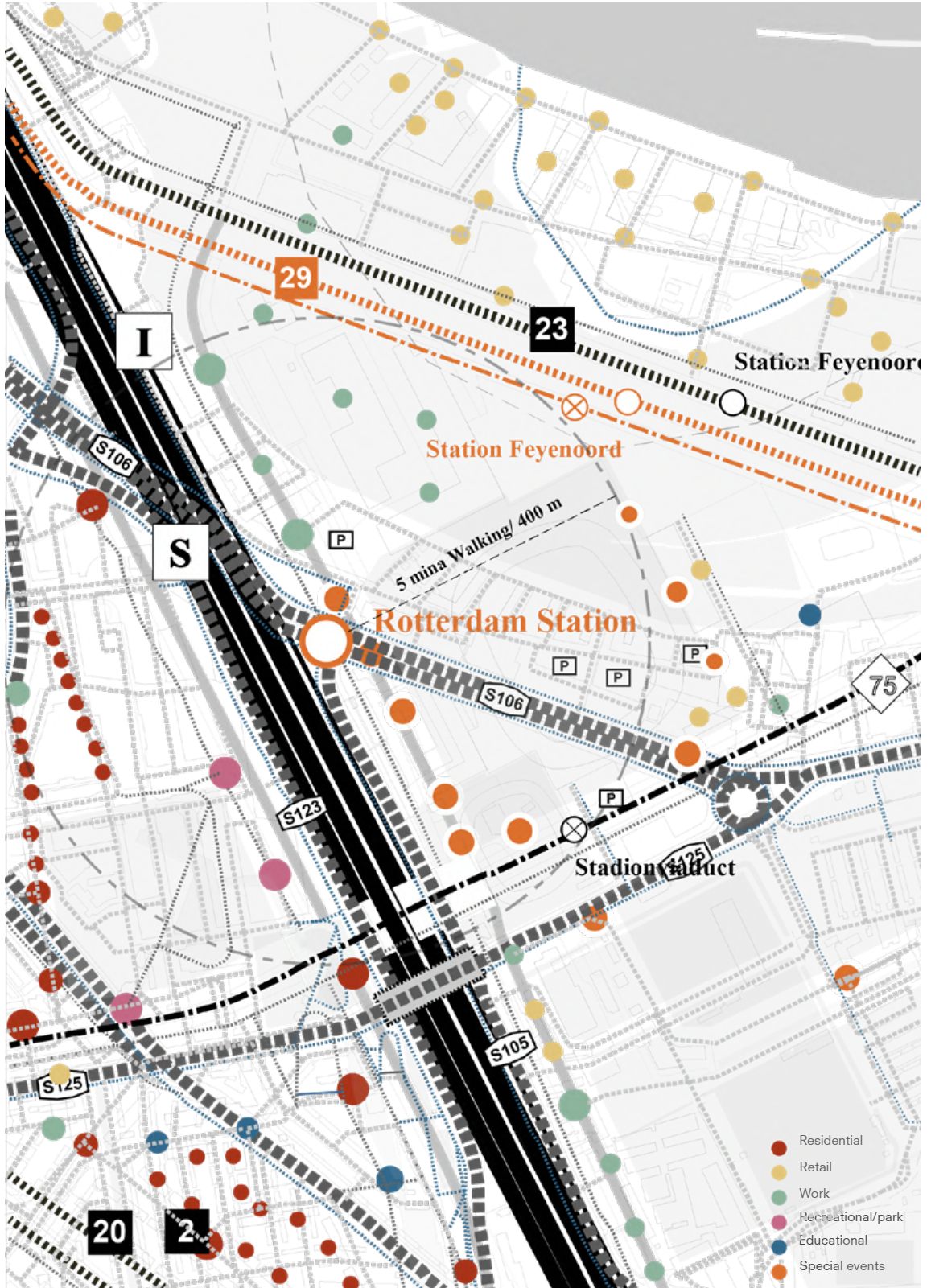

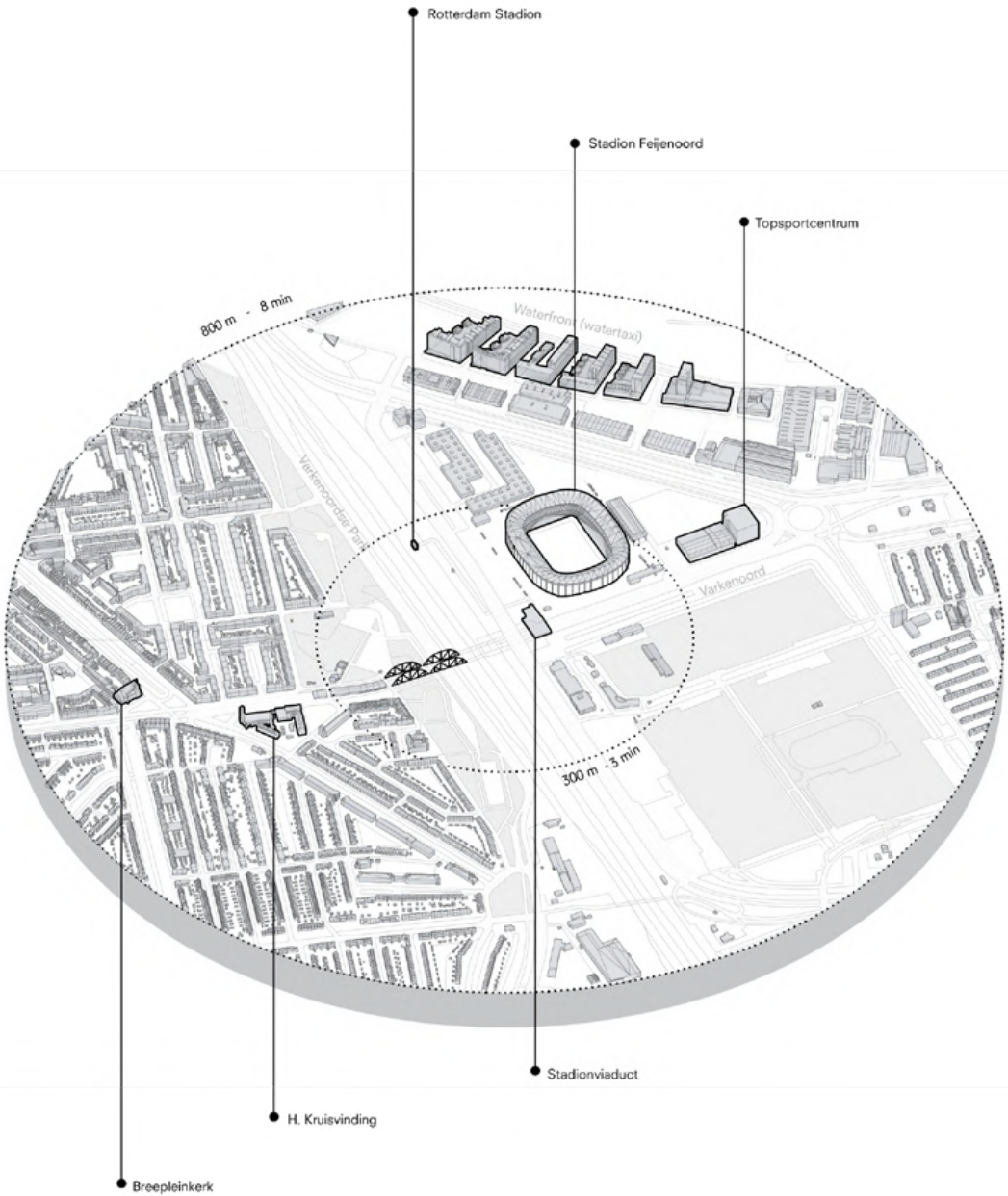



Feyenoord City Proposal
OMA
Source: oma.eu

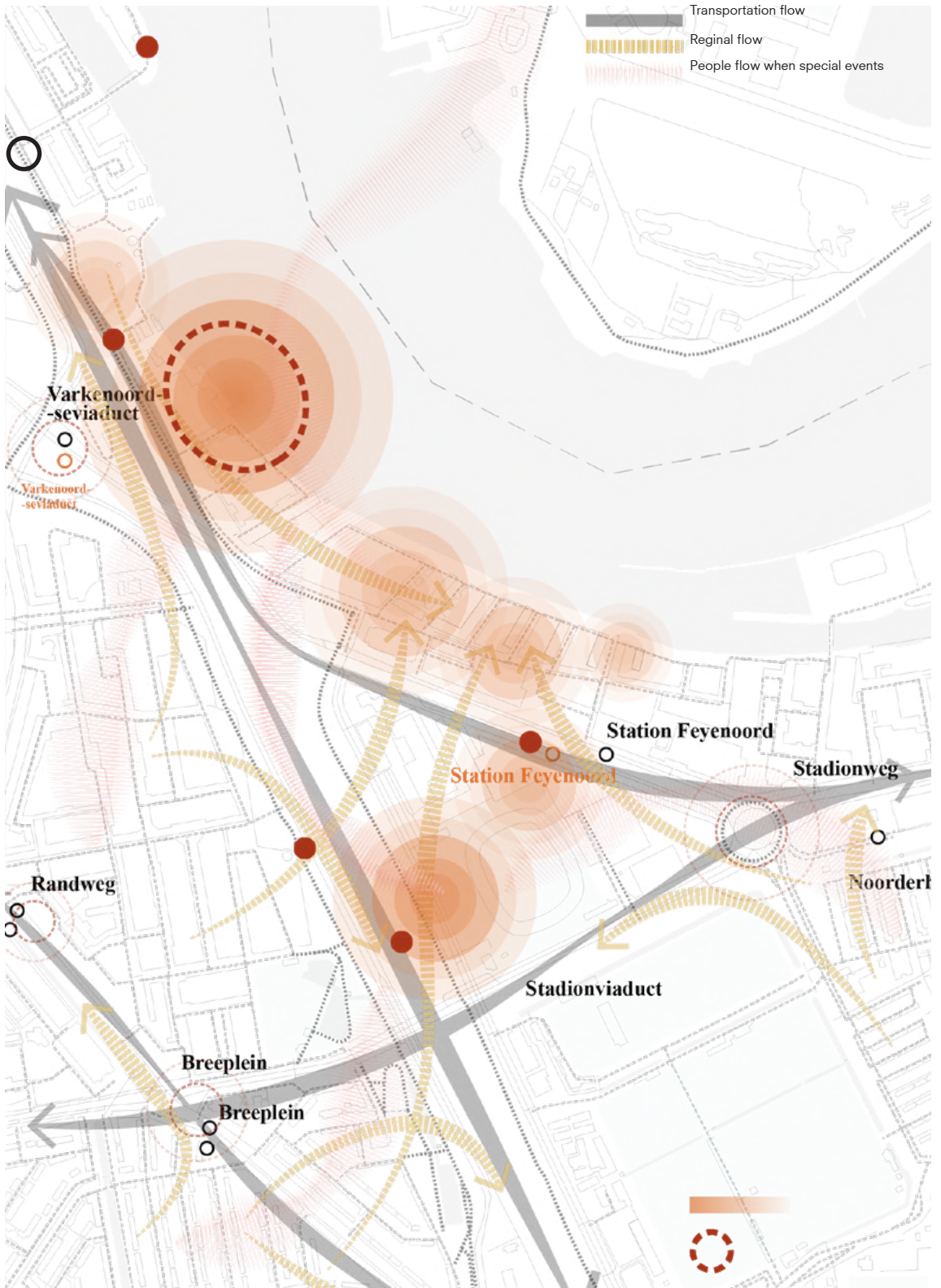

Prognosis of people flow and new transportation stops

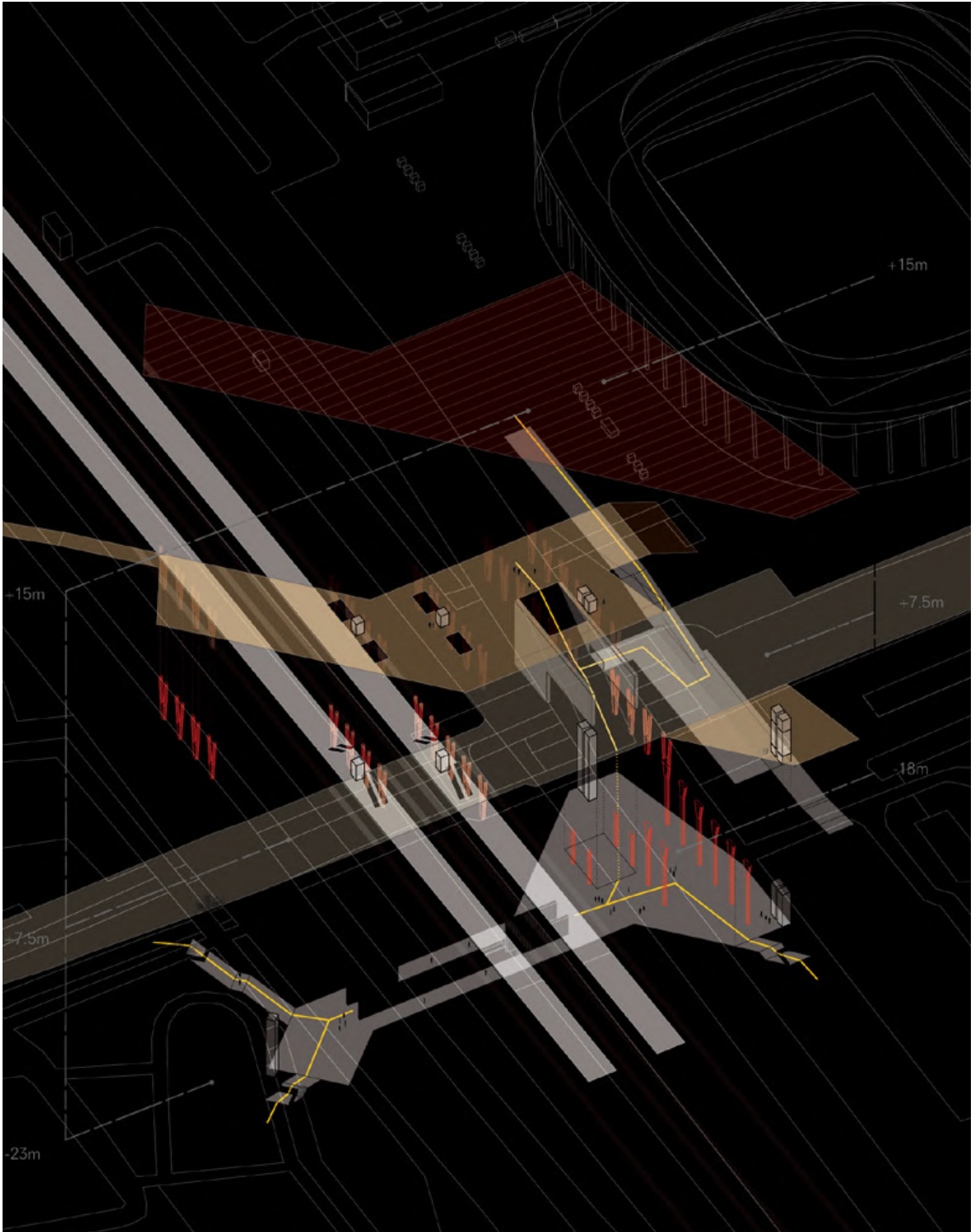

Feyenoord Area

Rotterdam Zuid Station
Node Value!

Gerjan Agterhuis
Su Gu
Diego Toribio Álvarez

Fragments Masterplan Subgroup Narrative

Firstly the positioning of the station is considered to be the matter of the highest importance at this point in the masterplan. This decision will be supported in the first paragraph. Secondly a narrative will be started in the second paragraph. This will deal with the desired ambiance and therefore quality in and around the metro hub. Also it should thus be made clear how the narrative of this proposal ties into the grand theme of 'la gare sensuelle'. Thirdly, the major architectural results that flow forth from this narrative will be discussed. This will also involve the likely position of the main entrances. It is also important to mention that unlike other potential investigations into new metro stations, the station in Rotterdam Zuid (this proposal) has to deal with extra factors. These are: multi-modality, crowd-control and a neighbourhood desperate for a new impulse. These challenges make this a distinguishably different project.

Final position

The location close to the Breeweg overpass had been chosen to be the site for the station in the masterplan. This conclusion is based on multiple grounds. It is from a technical standpoint the most sensible solution. The tunnel can be dug underneath the Breeweg, prohibiting any possible risks of soil subsidence. Secondly it creates the possibility of integrating any new public transport lines on the Breeweg. In the current situation this merely consists of a single bus line, but the full potential could be further researched. Thirdly, the position relative to the developments of Feyenoord city (see plans by OMA) could prove to be interesting. The visitor of the new sports temple (Feyenoord city) would start his journey with the old Kuip. Practically, still the 'pièce de resistance' of this area for the foreseeable future. This theme will be further elaborated on in the paragraph on 'the narrative' of this proposal. In fourth and final place, the station at this position can be the crown jewel at the end of the strip as proposed by OMA. The architecture does therefore not need to be submissive to the architecture of the dwellings. It could be a standalone piece amidst the architecture of Feyenoord city. It does not wiggle itself in like an outsider, but it becomes a concluding piece.

Narrative: Act 1

Now that the position of the new metro hub has been asserted the desired qualities can be described. This will be done by creating a narrative. This somewhat subjective research method allows for the description of qualities regarding the ambiance and usability.

The uniqueness of this place flows forth from the fact that with the new train station, this area suddenly becomes accessible for regional transport. Combine this with the connection to high quality public transport such as a metro this becomes an important meeting place of a variety of visitors potentially. A soccer fan on match day. An inhabitant of the new Feyenoord city towers going to work. An inhabitant of the region coming to work on the strip. A tourist who comes to shop and walk around the new waterfront with the new Feyenoord stadium. A resident of the nearby neighbourhoods to the west, going to school. The possibilities seem endless. This is what makes this station quite unique. To unlock the full potential that the future may hold for this area of Rotterdam, the metro hub should be accordingly dimensioned. The soccer enthusiast and the resident should have an equally tailored experience. This experience will be one of a high quality public transport hub where one can easily find his destination without being interrupted or feeling rushed.

Since the Feyenoord soccer club is such an important part of the narrative of this area of Rotterdam, it is believed that this should influence the narrative of the new metro hub. With the construction of the new stadium close the Muse river and the interconnecting 'strip', this area becomes a sports-dominated area. The old stadium is an important part of history so it will never be fully demolished. So this Feyenoord experience could prove to be an interesting part of the narrative. When one leaves the station at the most southern point of the strip, they are greeted by the old stadium. Which in the plans by OMA will be converged to a community sports facility. One starts the journey with 'the old'. Going up the strip, they can see the contours of 'the new', towering above the horizon, while still walking through the high quality new neighbourhood projected by OMA. This is eventually only one of the narratives by people coming from the new metro hub, but it is thought to be the most influential one when considering the current situation.

ATRIUM

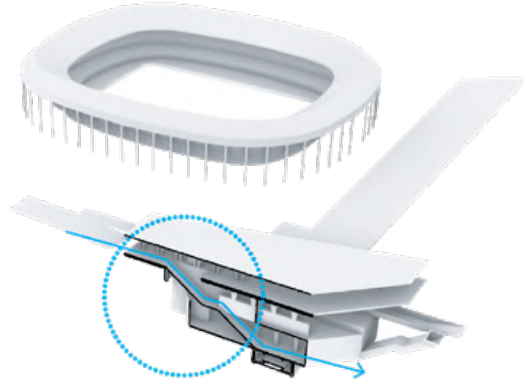

METRO PLATFORM

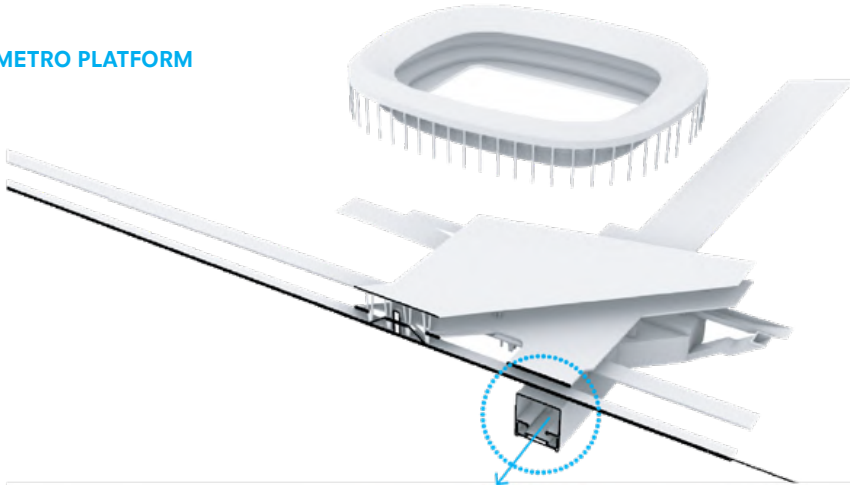

ROOF DESIGN

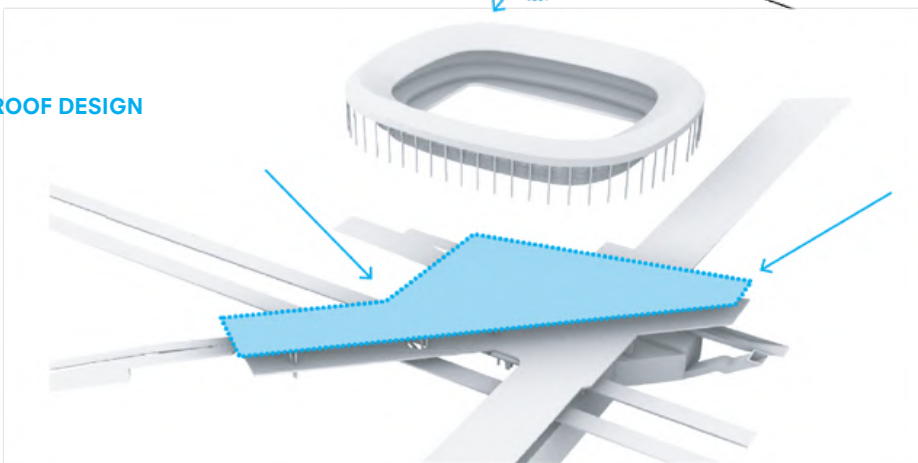

Fragments Masterplan Subgroup Narrative

Considering that 'square-meter-wise' this area is mostly dominated by residential areas, many of the daily users will be inhabitants of the south of Rotterdam. This is the second most influential user pattern for this proposal. The daily user should be able to see and feel the possibilities that arise from having this new transport hub amidst the neighbourhood. This could be supported by the idea that this transport hub is the gateway to more jobs (maybe the multi-modality of the station attracts new business to the area as this has become one of the most important factors for a business climate). Even the opportunity to study further away from one's home as the travel time decreased is something the inhabitants will benefit from. This will therefore be one of the headlines in our narrative and should therefore be incorporated in the designed environment.

These two main groups of visitors will find an environment focused on multi-modality, efficiency and high quality public space. A nodal environment which allows for the 'place' to develop over the coming decades and still be up par. This doesn't mean that a sterile environment is the only logical solution. Since the station is unique in this part of Rotterdam it is the start of many a journey. Like the central station of Rotterdam, it desires to be a gateway to an unfolding city (centre). It directly ties into predicted flows of people to be able to have a functional supply and demand balance. Programmatically this will also be the case. 'La gare sensuelle' will be represented by the architecture. Sharp and modern design will give the visitor a warm welcome into one of the most developing areas of Rotterdam.

Architectural demands

As soft qualities are now discussed the transition towards architectural typologies can be discussed. This theme will be subdivided into subcategories to be able to address all critical elements accordingly:

1. Public Space (Vertical alignment / levels / elements)
2. Artefact (station building / roof / style)
3. Dimensions (Functional dimensioning)

1. Public space

The public space is like with any other station one of the most important elements. It allows for large crowds to flow through the station, while making sure everybody has a pleasant stay when they need to kill some time. Rather than the artefact itself it takes first pick when it comes to the design process. For this reason the major elements that will function as public space will be described.

Firstly, a public space flowing forth from the strip as projected by OMA. This should receive and distribute all visitors of the Feyenoord area. This should take place on ground level. So underneath the car overpass (Breeweg) and above the metro tunnels. It is important to study the influences of the car road (Olympiaweg), as they might affect the desired ambiance. This public space should also connect to the planned underground bike parking. This bike parking will be placed at -1. It also attaches to the atrium on the position where the stairwells are split to allow for an *entresol*. That combines the flows of people. It is estimated that this *entresol* will catch enough daylight from the atrium to allow for a pleasant public space.

Secondly, A crucial piece of public space being a train terminal. Important to the success of this proposal is the positioning and dimensioning of this element. It should cover the desired 4 platforms, but also consider housing significant other functions like restaurants and other forms of retail. This functional arrangement will on its turn have to be researched to come up with a suitable design. As the train tracks are positioned on ground level, the question arises whether the train terminal should be positioned on -1 or +1. As this node seeks for an architecturally outspoken design, the +1 option seems favourable and will therefore be kept as first choice until otherwise explained. This also means that at this same +1 level there should be connectors leading from the train terminal over the remainder of the tracks to the public space on either side of the train tracks. These elements could also greatly influence the positioning of terminal as a whole. This will be discussed when the plan is being developed. It should be noted that the expected amount of visitors on peak moments is a crucial normative demand here, considering a match day scenario. The public space surrounding the train terminal should be attuned to this demand.

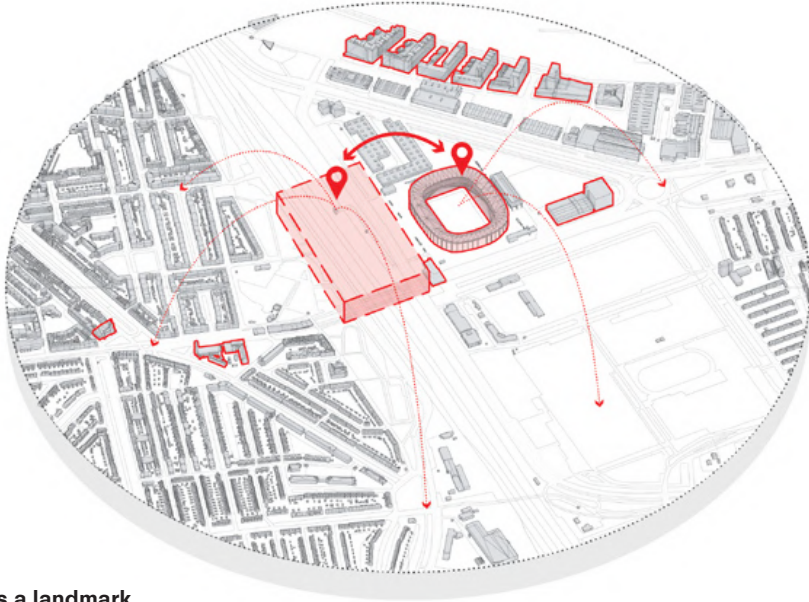

Station as a landmark



Fragments Masterplan Subgroup Narrative

This same demand goes for the public space connecting ground level to the metro platforms. As they are positioned at -23m, the labyrinth of stairs and escalators will hugely determine the practicality, usability and ambiance of the metro. Therefore also the performance of the node is affected, although it is not as visible for the eye when approaching the station as visitor. Connecting the entrance points properly to the public space inside the node will be crucial for the functioning and ambiance of the Rotterdam Zuid station. This flow of public space will also be of importance with regard to the theme of 'la gare sensuelle' as it greatly influences our perception of our journey. To do this, the visitors by metro will be received by a great open space. The same openness as can be expected as with a soccer stadium. It allows them to position themselves in a grand environment where light projections on the large walls could show the history of the area. Four exists will lead the visitor then to their desired destination. The exit connecting directly to the station platform will be the most important of these four and will therefore be dimensioned accordingly. The other three exists will deal with flows on the scale of a single neighbourhood. The exists are connected via an open terminal that sits a 1 level above the metro station, at -2 (roughly -18m below NAP).

As more large elements are required they will be discussed further along in the process. The role of the existing overpass (Breeweg) as public space will one of those themes that will need further research to be able to assess its potential. It does have some practical but also visual and logical benefits. In the current state of this masterplan it is expected that the non-arch-bearing structure could be replaced. Hereby, the entire perimeter of the station is new and improved and doesn't require intricate remodelling operations. The arched bridge can then be replaced whenever necessary. The first proposal for this solution is shown below in a circulation diagram. The shape of the train terminal is also included. In section 2. Artefact this shape will be immediately explained.

2. Artefact

The topic of artefact will be mostly focused on the metro station and the shape of the train terminal. Other visible artefacts in the master plan have not been researched enough to be able to be discussed in this section.

Firstly, the train terminal will be discussed as this is the most visible element. The public space at +1 (the train terminal) will therefore need to be covered. Since the four platforms and two of the four metro exits end up at this hub, a large scale artifact is desired. Spanning all existing tracks. The car roads on either side of the tracks are ideally left outside of the canopy, because of air pollution measures that would have to be taken. The pedestrian bridges spanning the roads could for example be largely open-air to allow for a healthy environment. Whether a smaller roof should cover most of the pedestrian bridges is a theme that will have to be further researched. The major cover will be the roof over the terminal. Like a stadium it will be a light and industrial primary structure with a light and continuous 'truss-like' structure which spans the terminal. Layering the construction like this, it will resemble a 'stadium of modalities'.

Secondly, The metro station should be the underground little sibling of the train terminal. As the metro station is the main part of the masterplan, the focus on detailing will be on the metro system. This underground environment in combination with a high quality and modern environment awaiting the visitors at ground level, creates a unique opportunity. As a starting point of the journey towards the sport facilities it could create the ambiance of a sports cathedral. A large open void would greet the visitor. In this space a lights show could generate shots and visuals of history, informing the guests on the history of the club for example. As they move along the escalators to the top floor, they are greeted by an open view on the area.

The shape of the artefact is derived from a study into the major sight lines in the urban context. It also seeks to create a clear distance between: "the old"(the overpass) and the brand new platform (a plan to replace the eastern half of the overpass is under construction, as this could benefit the total life span of the station). The shape of the artefact also clearly focuses itself on the eastern site close to the new Feyenoord city. It is believed that with the current expected increase of inhabitants per neighbourhood the asymmetric point of gravity is justified.

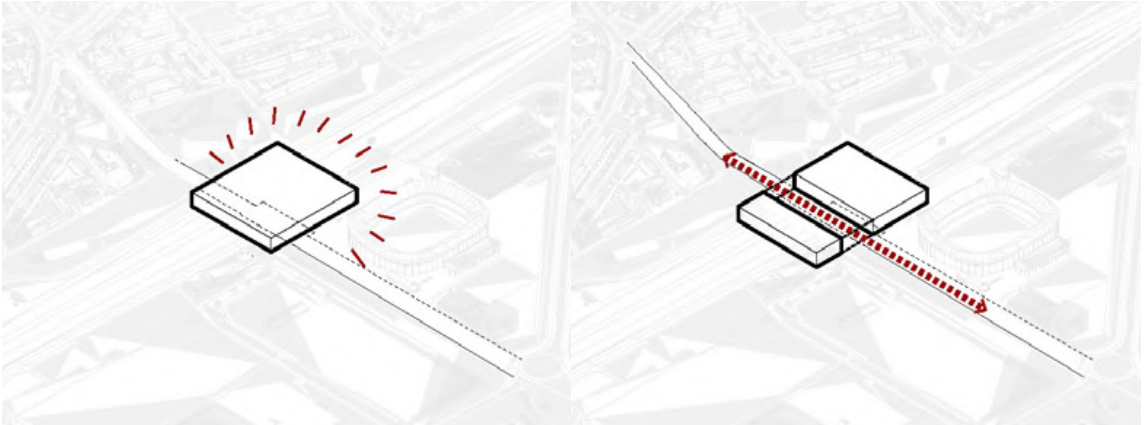

Diagram 1: Positioned on the overpass connecting train/bus/metro

Diagram 2: Splitting into two segments, to serve the fragmented neighbourhood while providing a clean way for cars on the overpass

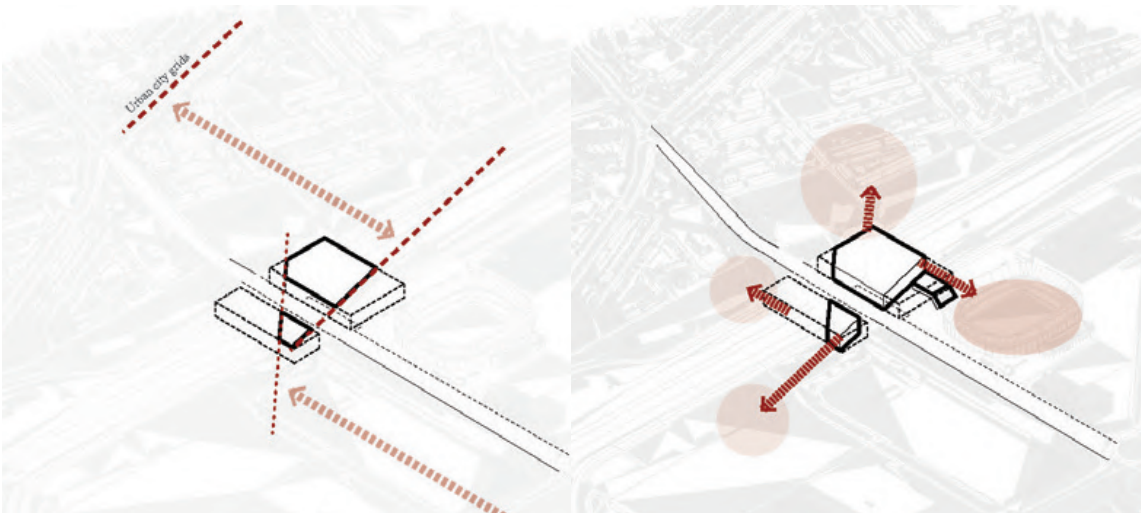

Diagram 3: Distorting the volumes to adapt to the urban city grids

Diagram 4: Creating accessibility to the neighbourhoods/ stadium for all sides

Fragments Masterplan Subgroup Narrative

3. Functional dimensioning

This chapter seeks to address the issue of coming up with quantitative data. As every other master plan the gross floor area is an important piece of the puzzle. For later reference, but also to estimate: cost, practicability, feasibility etc. It is therefore important to find reference projects that deal with modalities on roughly the same scale as in Rotterdam Zuid.

Function	Actual depth	Gross floor area [m ²]
Train terminal (+1)	+7,5m	5000 m ² [estimation based on 3D model]
Metro terminal (-2)	-18m	6000 m ²
Metro station (-3)	-22m	1200 m ²
Bike parking (-1)	-8m	1600 m ²
Train platforms (0)	0 (checkpoint)	8000 m ²
Public square attaching to strip (0)		4000 m ²
Retail and shops (+1)	+7,5m	500 m ²

The relation between gross floor area and the match-day scenario was outside of the scope of this research. To future-proof the station design this will however be required. For this masterplan only a few existing stations were considered to use as a reference. Other dimensions were subject to a degree 'estimation'. This helped keeping the project within the time scope.

Narrative: Act 2

As the project progresses, the design matures. Relevant themes and alterations with regard to the first act will be discussed in the second act. These themes are dealing with finalizing the shape of the train terminal's roof, improving the shape of the metro station to fit the overall concept and determine the final position of the atrium and more. There are four items to be addressed in relation to the interventions part. As this location includes a complex network of infrastructures the task of weaving a new network of public spaces in-between all these elements is thought to be a complex task. The four most important findings in this research will be discussed.

Atrium

When a train station and metro station are to be combined on one location, one could easily come to the conclusion that the possibilities for vertical displacement are of significant importance. The ambiance within this (connecting) public space is also of great importance for the well-being, usability, etc. of the visitors. For this master plan a location was sought after which could go down from +1 to -3 (according to the functional dimension table). As light doesn't bend easily, unless reflective materials are added to the mix, an open space straight down was thought to be desirable. Within the orange counters this was expected to be possible. This box is roughly +10 m wide and only requires a small adjustment to the road. The skylights in the roof were also able to be located above this section. In this way it could become the primary bearer of vertical movement. Eventually the public space needs to make a turn to end up at the central hall of the metro terminal, but for at least half of the 'journey down' the visitor is expected to be able to enjoy natural light. This location is therefore unique and crucial to set a certain ambiance for the public space.

Overpass

The overpass on the Breeweg/Coen Moulijnweg, has become an element to discuss as the design integrates a large part of this viaduct. There is no real use case at this point in the research other than the bus stops on the wider section of the viaduct (within the red box), but the overpass raises another vital point. As it is quite outdated, it could be up for replacement within the near future. The deck is supported by steel beams which have to side-effect of passing on a lot of vibrations from the heavy traffic. When this comes into contact with the new structure of for example the train terminal, this might create a hinder structurally but also auditory nuisance is possible.

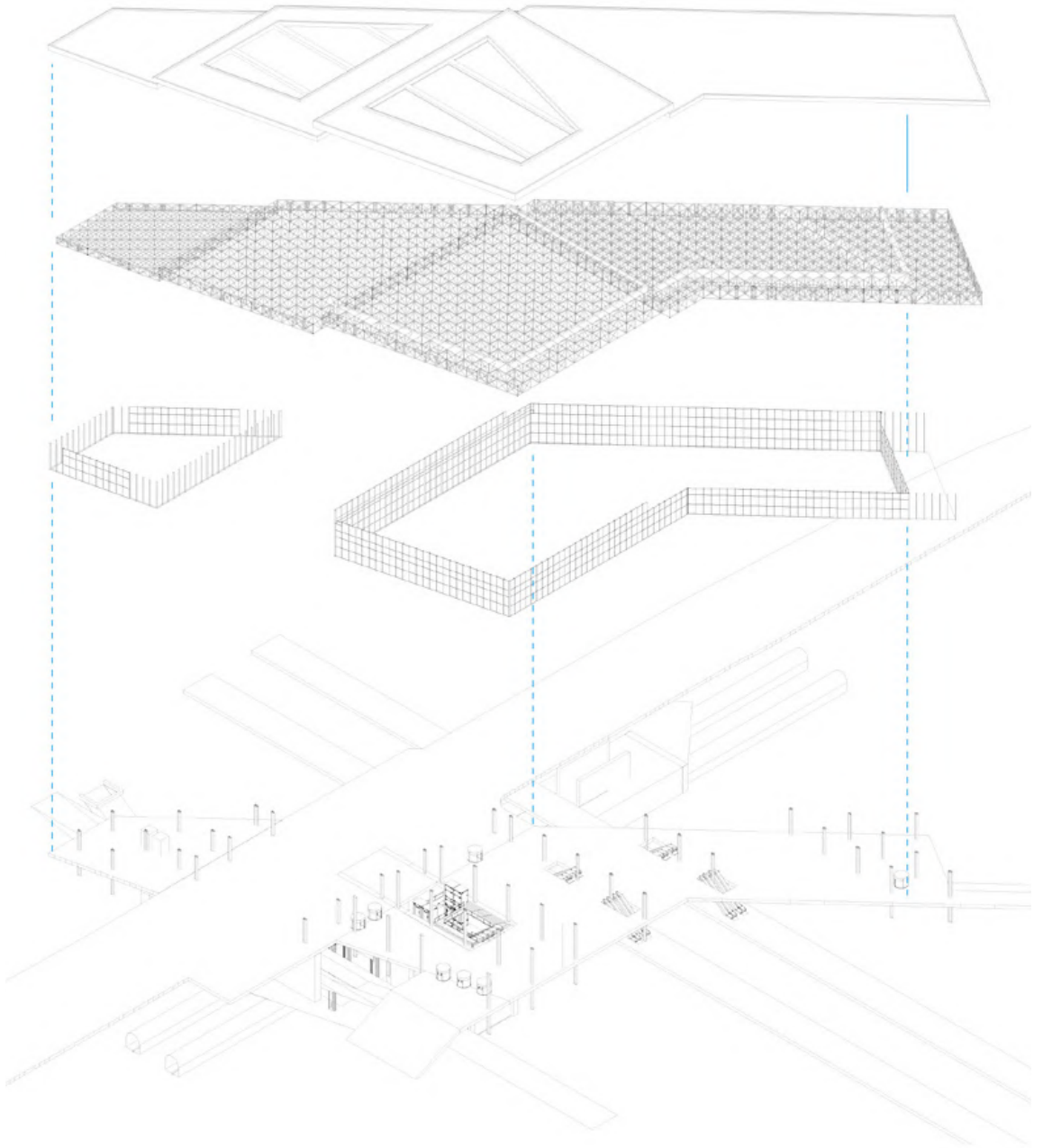

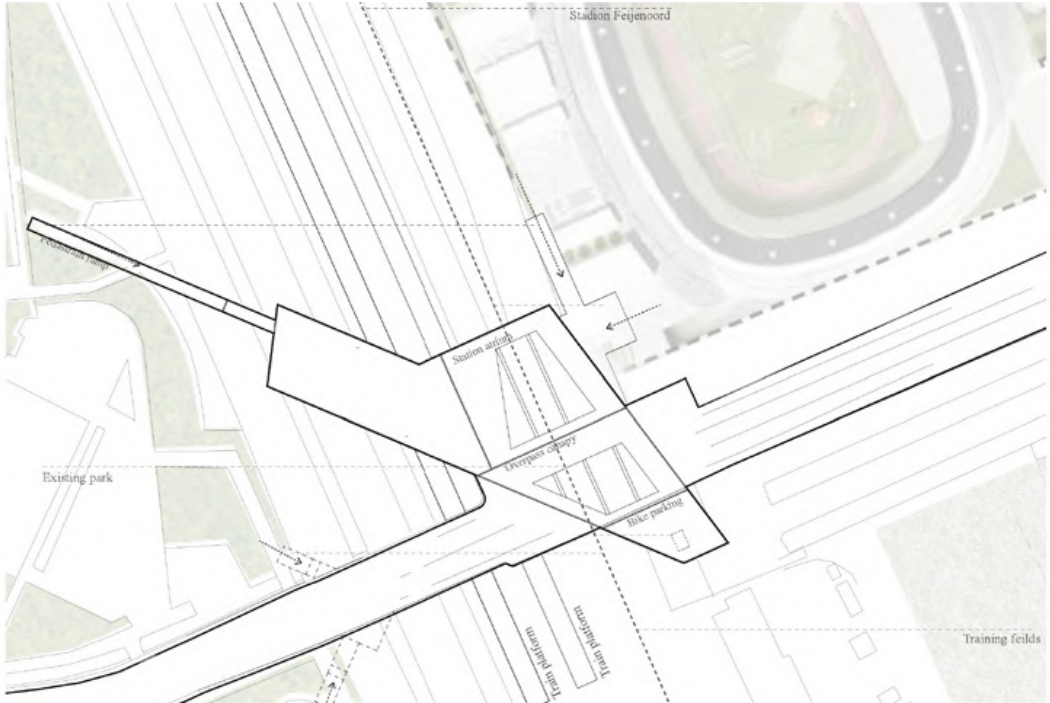

Masterplan

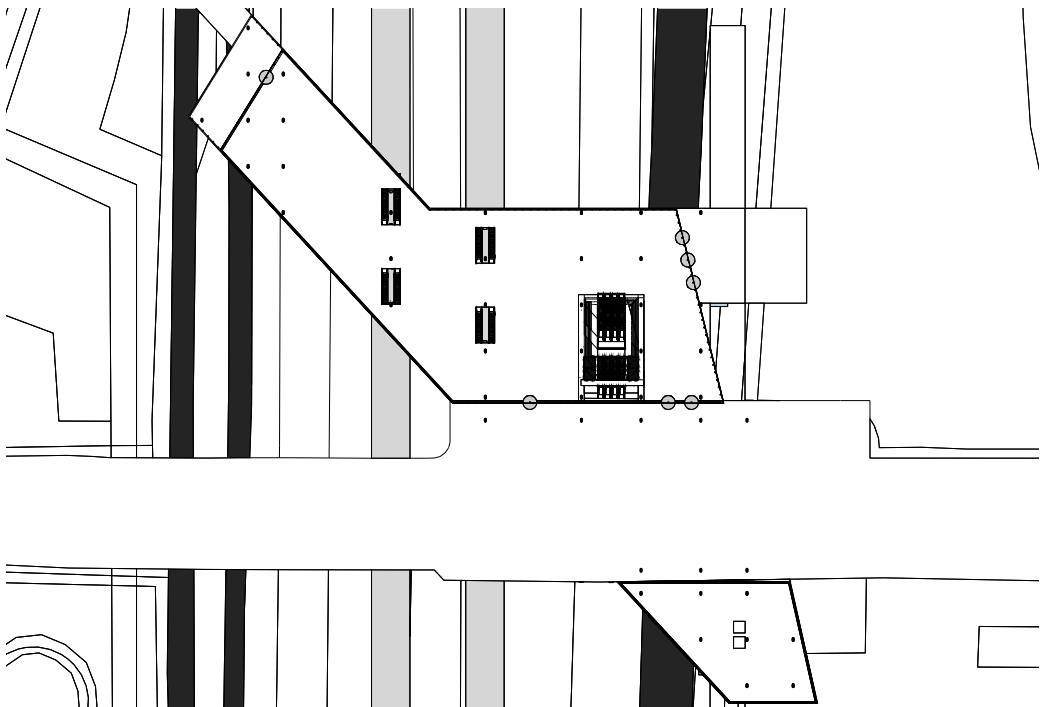

First floor with roof construction (Map for reference - doubles with chapter on Atrium)

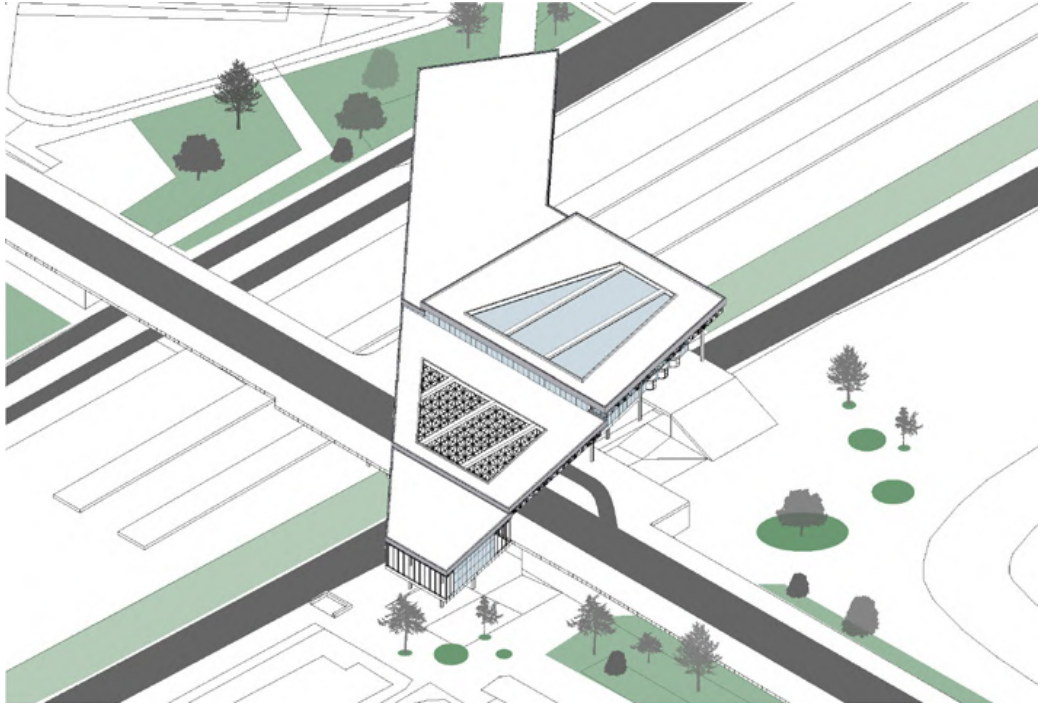

3D Isometric view of roof design

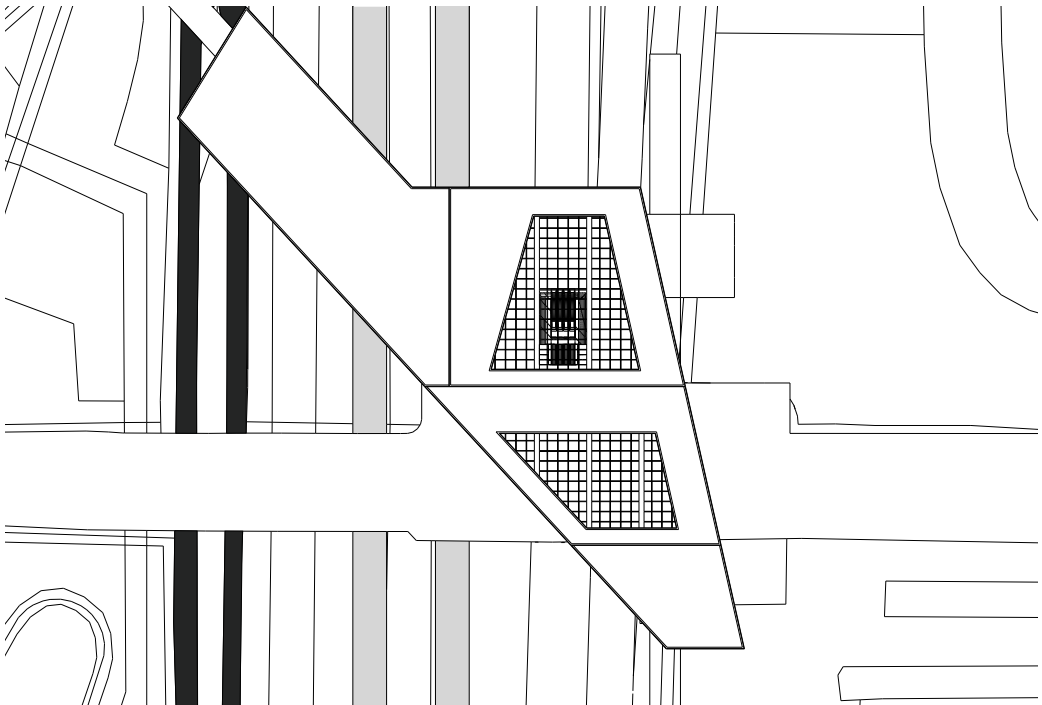

Roof plan

Defining the Roof

The Truss System

For this part of the masterplan, the roof of the hub will be covered. An above ground train station was opted for because it would fit the overall concept of the 'to be developed' Feyenoord city better, as this environment will be rich in dense and intricate architecture.

The train station sits directly opposed to the old Kuip stadium. For the design, this was an important given. As the Kuip will be rendered out of business as the main stadium of Feyenoord soccer club, an important artefact for the identity of this part of Rotterdam could be lost. OMA has shown plans to re-purpose it as a new type of public space in Rotterdam. However, as its future is somewhat uncertain it was thought to be an important piece of input for the overall master plan. The typology of the Kuip as a inspiration for the overall design, grasping its identity for many decades to come.

The grand experience of walking into a enormous open stadium is a unique experience. The openness and sheer size are an important part of the ambiance. Especially when filled with people. This theme was used to guide the conceptual stage of the train terminal. In the future scenario, when the new stadium is located at the end of the new strip, the station would be the beginning of the journey along the strip towards the stadium. This narrative of beginning and end destination further supported the concept of making a 'grand entrance' for this sport Valhalla.

To create a large open space and embrace the constructivist qualities of the stadium a large truss was tested. It allowed for a large and, above all, open space. This also agreed with the demands laid upon this project by the existing infrastructure. As the positioning of columns is made difficult by the existence of the railroad. It challenged the structural feasibility of the concept. It is thought to be preferable if the roof and floor structure can handle the large spans. This further pleads for the use of truss like construction (although it was not adopted for the floor of the train terminal). The construction was considered to be the most important part of the design. Alike the proportions of the Kuip stadium. The facade and secondary construction are very minimalistic in comparison to the outspoken truss.

A Felsen trimmed roof trim completes the truss and finalizes the stadium metaphor. It also completely covers the truss so the truss is fully covered by a fully sealed yet lightweight roof.

As seen from this perspective, the pedestrian ramp towards +1 (train terminal) is an important part of the design because of the connection to the OMA master plan. As a team we set out to cover this part of the master plan because it shows in important part of the embedding into the (future) landscape. This came to be outside of the scope of the research. Only three individual design teams could be chosen and the public space was thought to be subordinate to the architecture of the artefact for now.

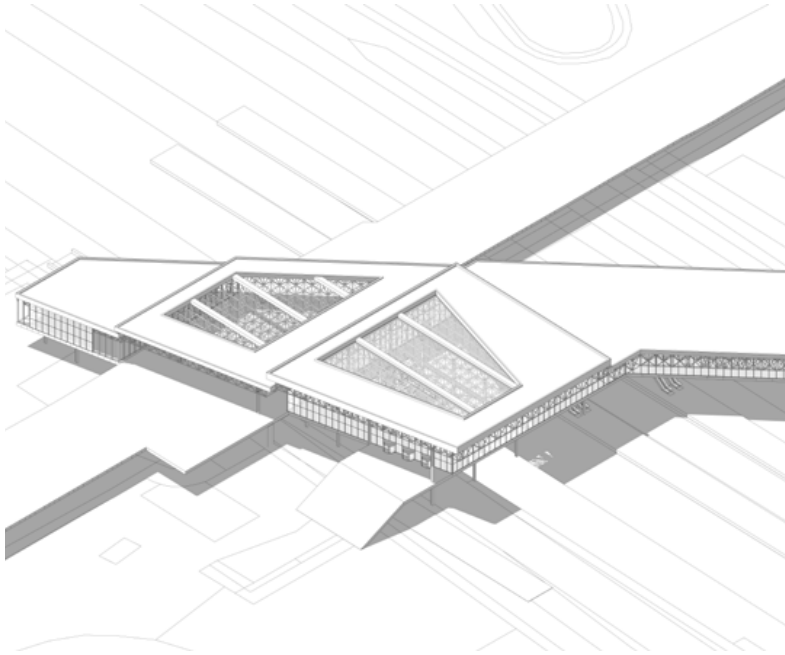

View on train terminal roof
Isometric Drawing

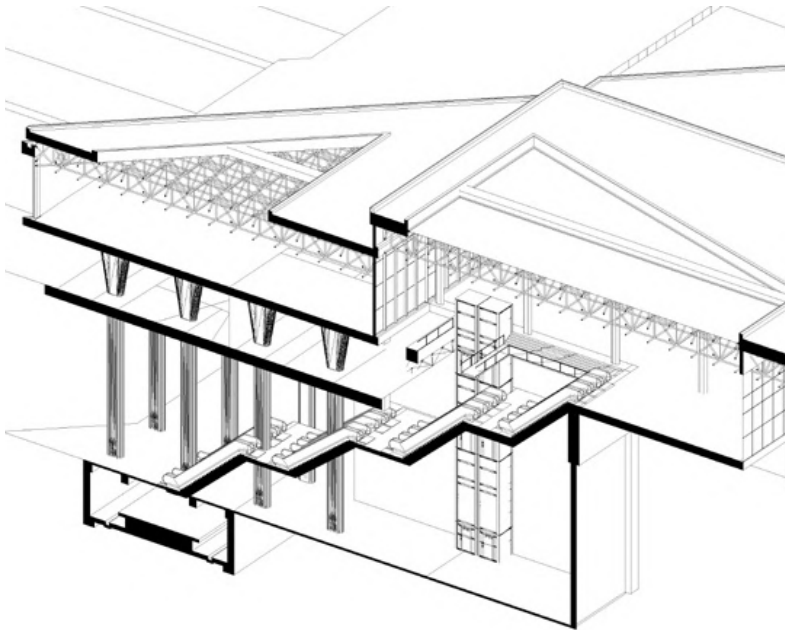

Section through atrium roof
Sectional Axonometric

Defining the Metro Station

Skin & Pelt

María Langarita and Victor Navarro, founders of the Spanish architecture studio Langarita-Navarro, are responsible for the concept behind the design of the metro platform.

For a lot of years they have been researching about what they have called the relation between bust and pelt. This line of research focuses into rethinking cities from their material consistency. In this way, the bust impersonate what is inert, stable and indeed the solid city that we see.

However, there is another part of the city that is being erased and that is more related to an organic materiality, and with living bodies. Is in this second group where awnings, fabrics, moving elements, flexible elements and a big list of organic elements come to play. All of them inhabit our cities but due to its difficult maintenance they are removed or changed, rarely making any marks and leaving bust as the remaining object.

This research line, which is in fact a tool that tries to explain the complexity underlying our way of understanding our cities and architecture, helps to explain the design of the underground platforms in Rotterdam Zuid.

Due to the location of the project, and its attachment to the existing infrastructure, the metro line is not able to receive natural light anymore.

Architecture down there, will become a strong concrete bust that will eventually need some help from the pelt elements to reduce its hardness for users.

Thereby, together with the bust, a catalogue of pelts, dominated by a bending surface, could help in order to create a living station, comfortable for users and kinder for human activities.

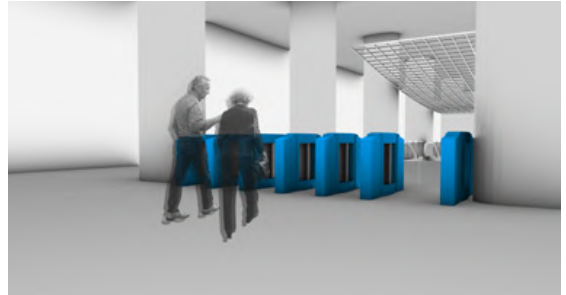

Tourniquets

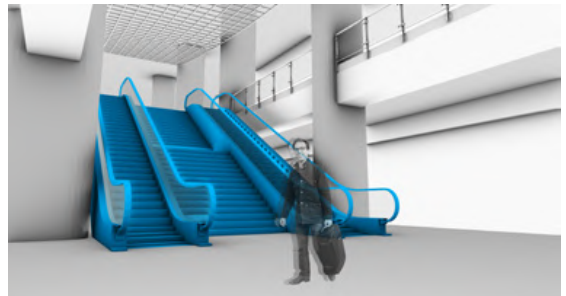

Vertical Movement System

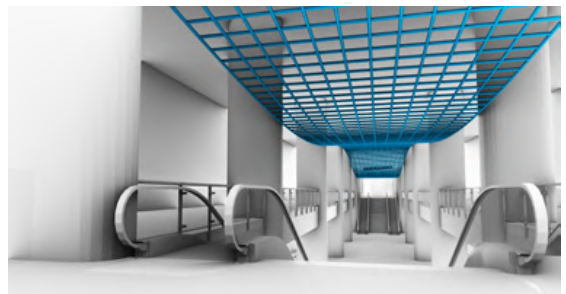

Kinetic Surface



Platform Columns

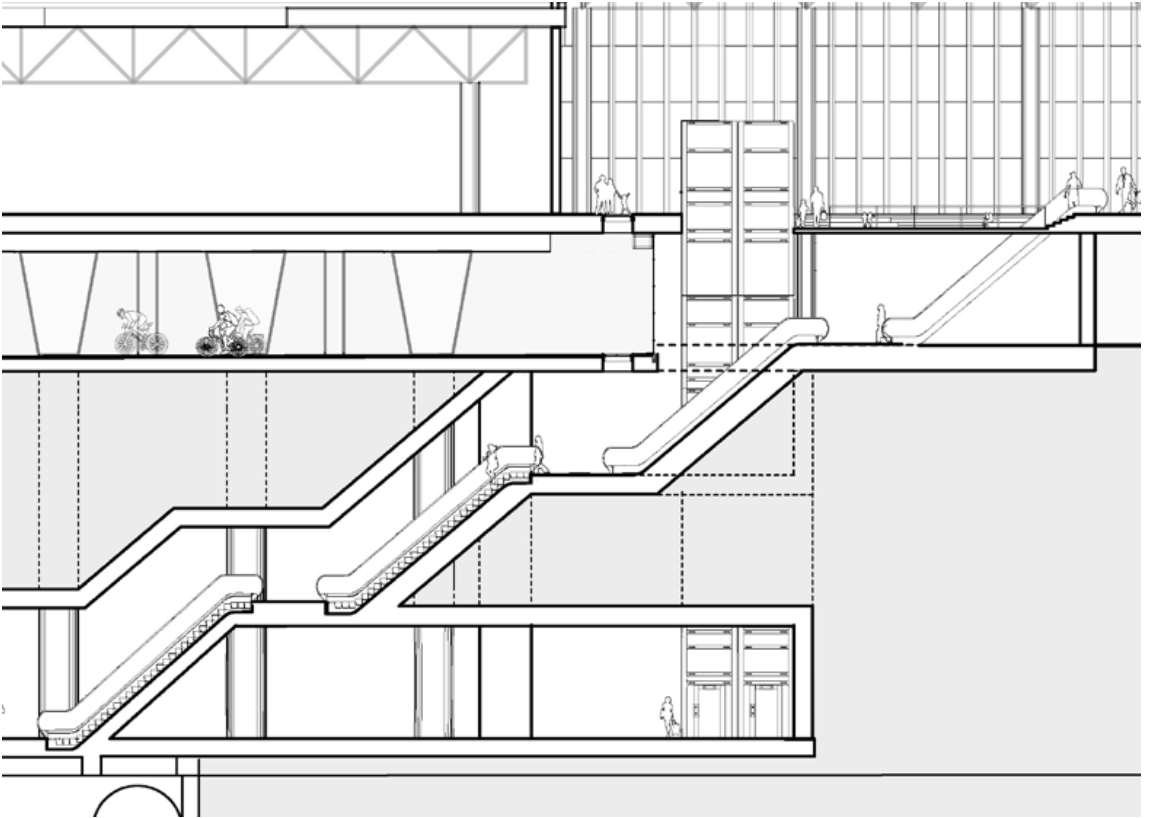

Section

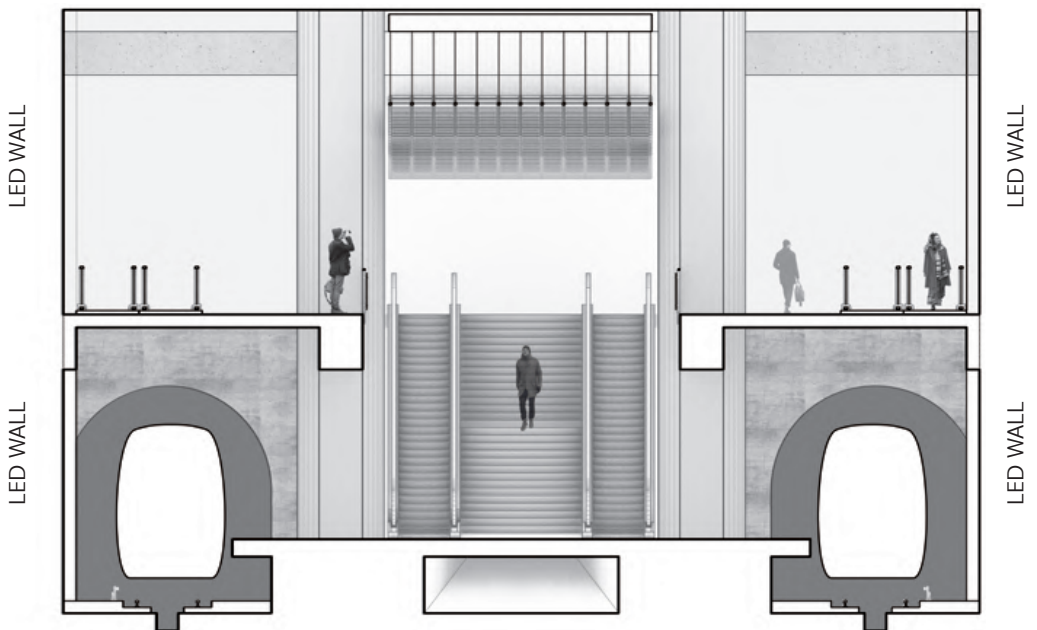

Cross Section

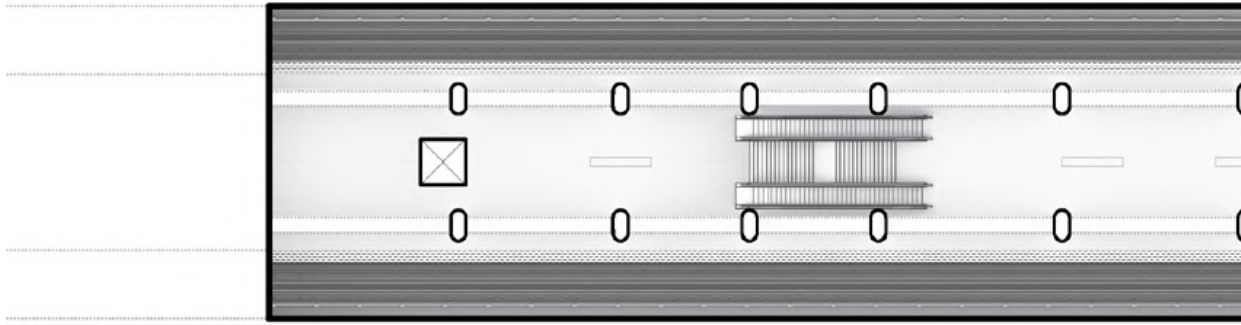

Platform Floorplan

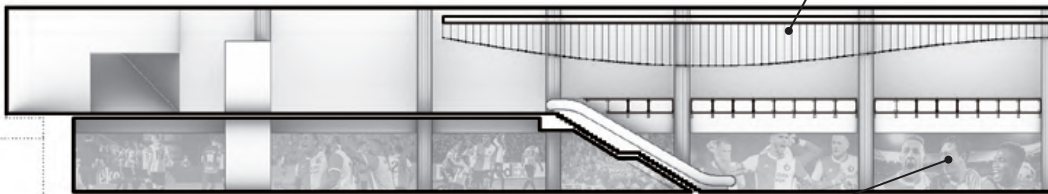
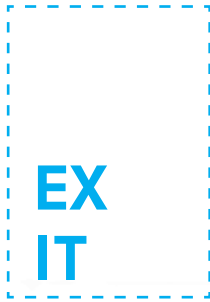

Kinetic Surface

LED Wall

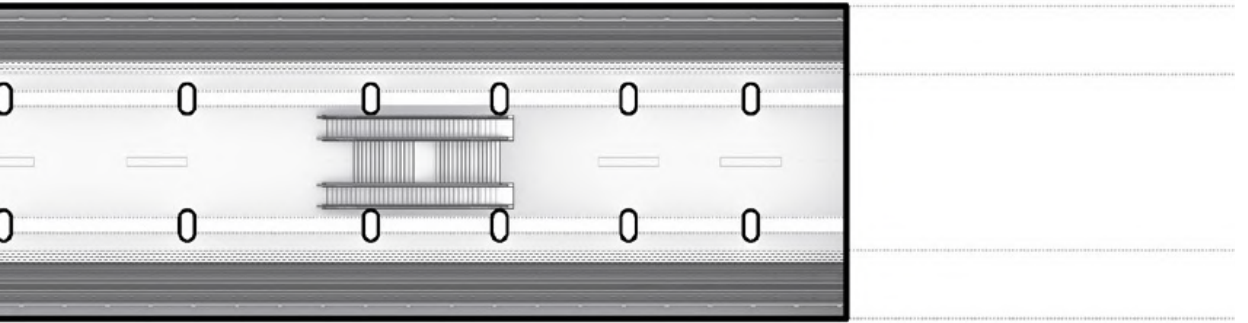

AT
RI
UM

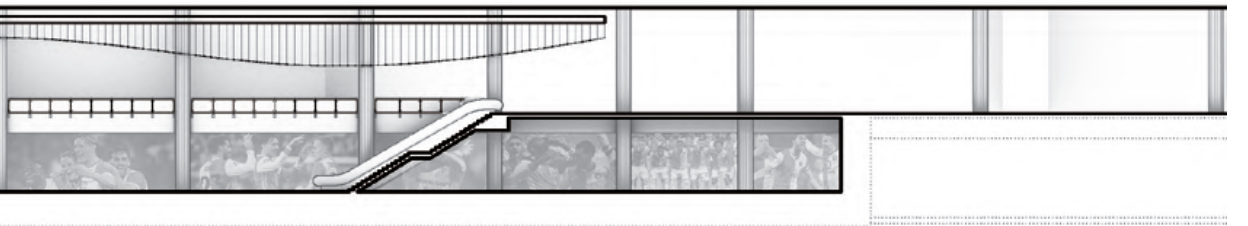



Connecting the Fragments

Rotterdam Zuid Station
Place Value!

Giannis Nikiforou
Jemina Lai
Laura Sacchetti
Rogier Tamminga

Design Project Introduction

Connecting the Fragments

Rotterdam-Zuid is a part of Rotterdam which hosts many citizens. In the neighbourhoods Feyenoord and IJsselmonde, more than 135.000 people are residents. The soccer stadium, De Kuip, is located in the middle of these neighbourhoods, right next to the Maas. The two neighbourhoods are divided by a wide railroad, already there for 140 years, which makes a clear and definite separation. There are bridges which cross the separation. However, these bridges are few and very much car-oriented. Pedestrians and cyclists have a space, but it remains unappealing and disconnected. The neighbourhoods to the east have an abundance of cars per citizen, and the area is very much car-oriented.

The areas around the neighbourhoods lacks a human scale and living environment. During night-time, this results in a desolate space. During day-time, the space feels harsh and unfriendly. Then, due to the prominent location of the soccer-stadium, there is a third situation: during match-days, the space is (over)crowded with people.

This stadium will get a new location, slightly moved to the north as proposed by OMA. The old stadium will stay where it is and will be transformed into a lively environment with new functions. The whole area will be revitalised, inserting over 1.600 dwellings, 64.000 m² of commercial functions and 11.800 m² of public functions. However, this revitalisation only focuses on the eastern part of the railroad. While this will be bright and full of life, the west side will stay neglected once more.

But plans can change. The west side, while being a vibrant and lively neighbourhood, has its issues. It has a scarcity of jobs, the housing prices are low, there is a high rate of criminality, especially subjective and people feel disconnected from the city centre. But on the other hand, the eastern neighbourhoods have their own issues as well. While the job rate and the housing prices are at Rotterdam's average, the level of services and amenities are very scarce. With a new metro station at Rotterdam-Zuid, there are plenty of opportunities. It will serve the people for going to the stadium, it will serve the people of the eastern neighbourhoods, and it will serve the people for the western neighbourhoods. But the metro station will be more than just a station. It will interact with the other public transport: the train station, which is now used only during match days, will be upgraded to a fully functioning intercity station. Moreover, an intercity station which is the hub for the whole Rotterdam-Zuid. The Rotterdam-Zuid hub will connect with bus lines and tram lines, and will be easily accessible for pedestrians and cyclists. Cars will still be welcome, but play a minor

role in the whole development. They will never form an obstacle for the other users, pedestrians and cyclists.

While the main function of the station will focus on infrastructure, the main function of the station as an area will have a different focus. The diversity of the surroundings will be used as an advantage, and this uniqueness will be exploited. The area will facilitate a place where all can mix and mingle, and where all want to go to look for what they need, and are curious for what they find. Where they will go meet people, and get inspired by refreshing initiatives. The station will be a large public space, where each neighbourhood will have their own place. The quality of each neighbourhood will be represented at the plaza, but also the needs that arise from each neighbourhood will be introduced at the plaza. It has places for initiatives, places where people can come up with their own ideas.

The train tracks form an essential part of the area, but are wider than they need to be. The west part will be made available. Reflecting and implementing the masterplan of OMA, the road to the east will be redirected, and the space will be available for pedestrians and cyclists. Where the plan of OMA proposes a heightened strip, the station area will make a contrast, and go underneath the train tracks. Around four to five meters underneath the train tracks, a large, open urban space will emerge. A roof will be left out, except for occasional canopies, and the train tracks passing over. From the west as well as the east, this plaza will be easily accessible for all people. This plaza will be filled with the aforementioned shops and activities, reflecting the multicultural and diverse inhabitants. Dwellings will be strategically placed, so that they have minimal nuisance of the necessary noise, but keep the place vibrant at night as well as during the day. There will be an abundance of green, and special areas will be made available where a surplus of water can be temporarily stored.

The new plaza, together with the station, will have the identity of each neighbourhood in it. The inhabitants will be able to identify their part of the city in the plaza. Moreover, the area will represent its own identity, larger than the individual neighbourhoods, but representing the role the station plays in Rotterdam: as a node in the network of Rotterdam and a hub for the whole of Rotterdam-Zuid.

Approach

Connecting the Fragments

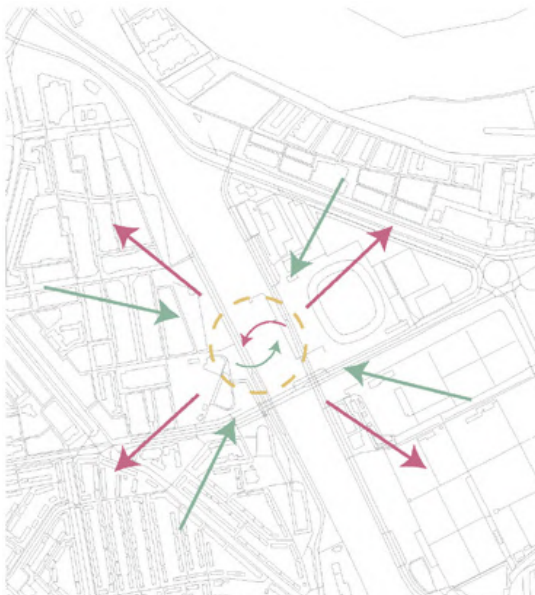

Diagrams: fragmentation axes, drawing the local flows, collecting visitors, connecting the flows and the neighbourhoods.

Design Project Introduction

A new urban space designed to connect

The plan consists of multiple stations: a metro station 24 meters underground, a tram stop, a bus stop, and a train station. The metro and train station are placed on top of each other, the tram and bus stop are located at the west side of the area. To ensure a good connection between metro and tram, verticality is important. The vertical passageways, going up from the metro all the way to the train at ground level, and the other way around, are crucial in this hub. On the other hand, the horizontal connection is important to relate the station with the neighbourhoods, and the neighbourhoods with each other. The relation between this verticality and horizontality is an important theme. Just next to the area is the Kuip Stadium, the stadium of FC Feyenoord. This is an important landmark and has a high cultural value. It is important that the new station amplifies this value, and doesn't compete with it. There will be a new stadium the Kuip north of the current one, and a large pedestrian route, the strip, connecting both stadiums and the station. This strip is designed by OMA and includes facilities and residential towers. In reaction to the stadium, which has a huge height, the new station goes underground. One large horizontal platform, the plaza, connects west and east, and vertical connections reach this area. Two large holes in the ground lead the way to the metro.

The designed plaza forms the natural continuation of the strip: where the strip as proposed by OMA stops at the old Kuip, and the station, this plaza let the strip continue to the other side of the train tracks, into the neighbourhoods to the west side. From the analysis, this was highly necessary, since these neighbourhoods feel neglected and can be improved. A good connection is vital for the improvement of these neighbourhoods, as well as a new tram line connecting the west neighbourhood with the new stadium. There are several possible routes people can take in order to access the new stadium with the two main routes to access the stadium enabling the splitting of a large crowd.

The plaza itself takes the character from both sides: urban, with a sportive touch, as connection with the Kuip and the new plans of OMA, and green and playful as connection with the western neighbourhoods. These elements join freely together, the green spreading out towards the east side and the urban and sportive character to the west side. This is crucial for the plan: the idea is not to simply let both neighbourhoods touch each other, but really connect them and let the people from both neighbourhoods mingle in this large collective space.

Urban Plaza

Plan Organisation

The urban plaza is the large horizontal plane where the people gather. The vertical connections with train and metro start from this point, and the plaza itself is the connection between the east and west side of the train tracks. Pedestrians have all the space they need here: cars are not allowed and bicycles can go underneath, via the intermediate level.

The urban plaza is shaped by a few elements. First of all, the vertical connections are important: two large openings in the ground lead to the metro, and a central part in the middle leads to the trains. This is connected by an oval space, relating to the inside of a football stadium. But where the inside of the football stadium is the lowest, at the urban plaza it is inverted: around the higher oval lies a lower sports area. Stairs are placed all around, not bridging the height difference, but also forming a natural tribune on which people can sit and enjoy the surroundings.

The openings leading to the metro form a contrast with the surroundings, especially on the east side: where the Kuip stadium appears high in front of you, the metro opening amplifies this verticality by going down. In the inner oval, more gaps are made to bring in light to the lower parts of the station, and also give a visual connection between different levels.

There are two elements that reoccur at the urban plaza: one is the green, resembling with the green area on the west, the other is the urban sports character, resembling with the Kuip on the east. Both flow underneath the train tracks and mingle in between: the green pops up in the eastern part and crawls over the whole urban area, the sports character runs around the higher oval and extends on the western part. The materiality of the urban plaza connects with these elements: at the sides, the south and the northern part of the urban plaza, wooden floors and buildings relate with the natural character. In the middle, the higher oval and the sports area, concrete and asphalt make up the more urban space. On top of the higher oval, all the buildings resemble with the green, the mingling does continue here as well. Also the train connection is built in wood, it connects with the vertical layer: green pops up out of the ground from the metro platform, vertically up towards the train platforms.

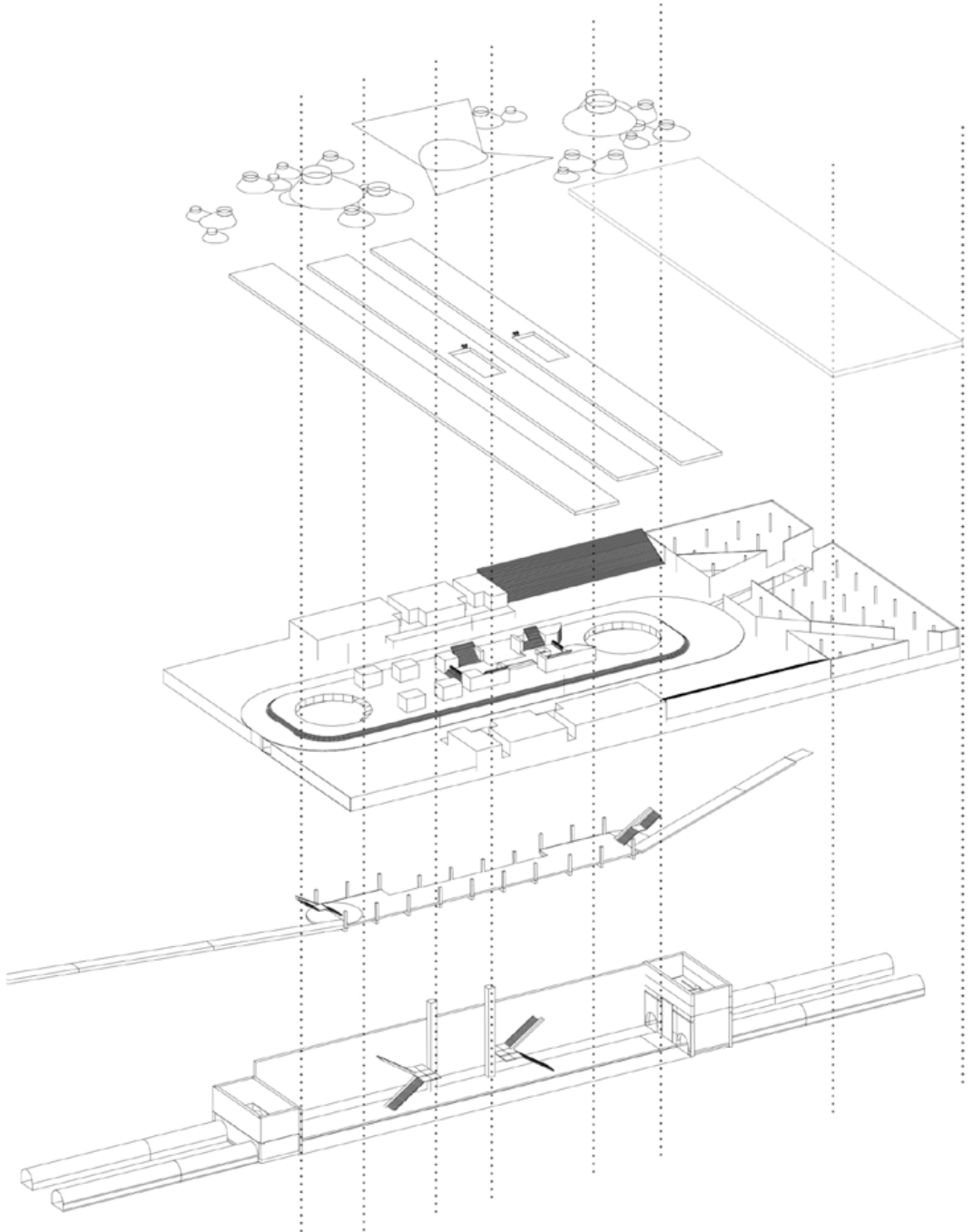

Station and Urban Plaza
Exploded Axonometric

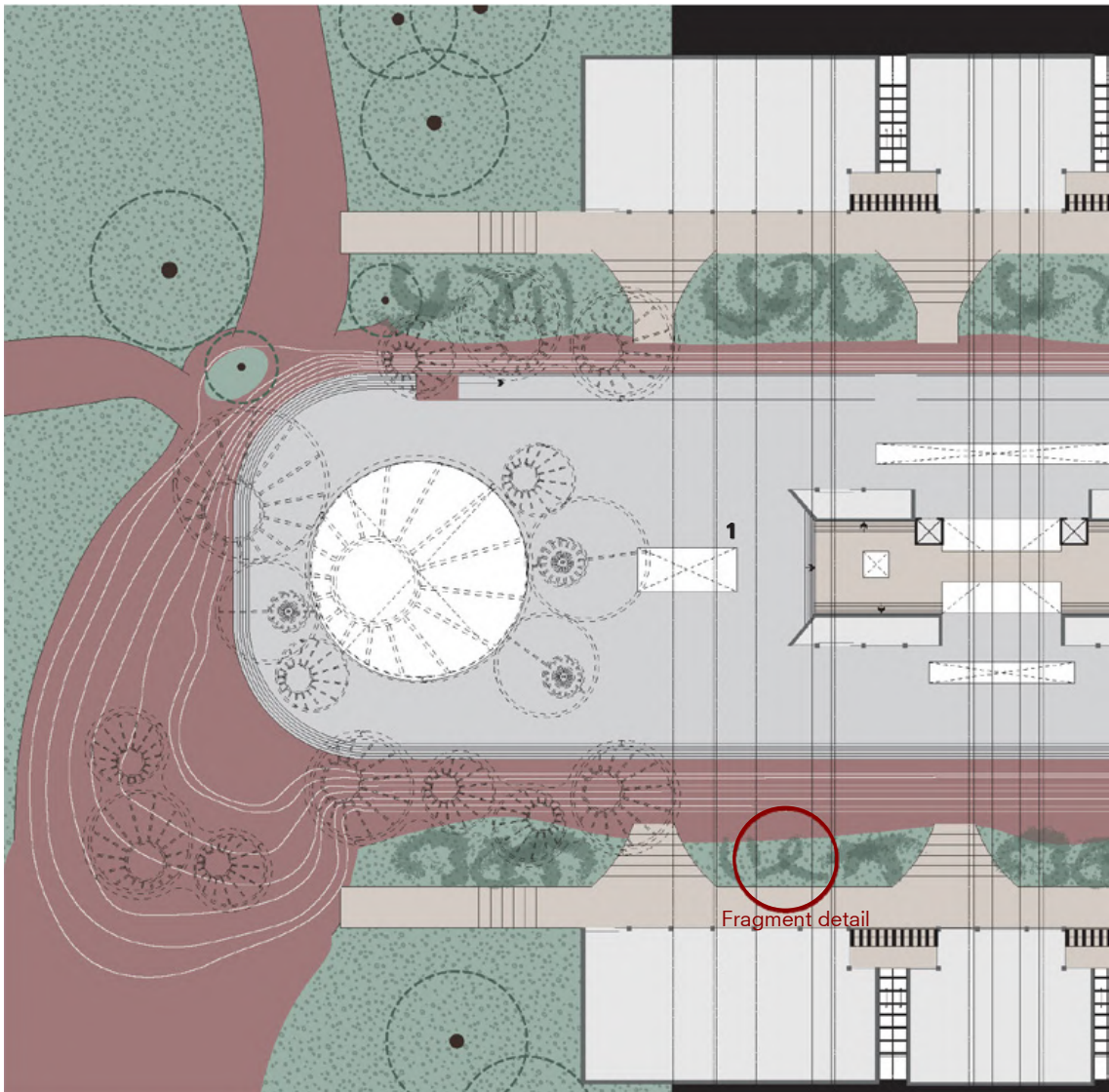
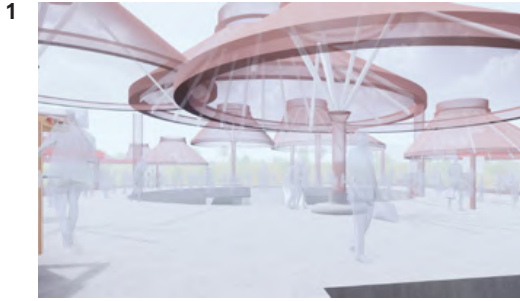

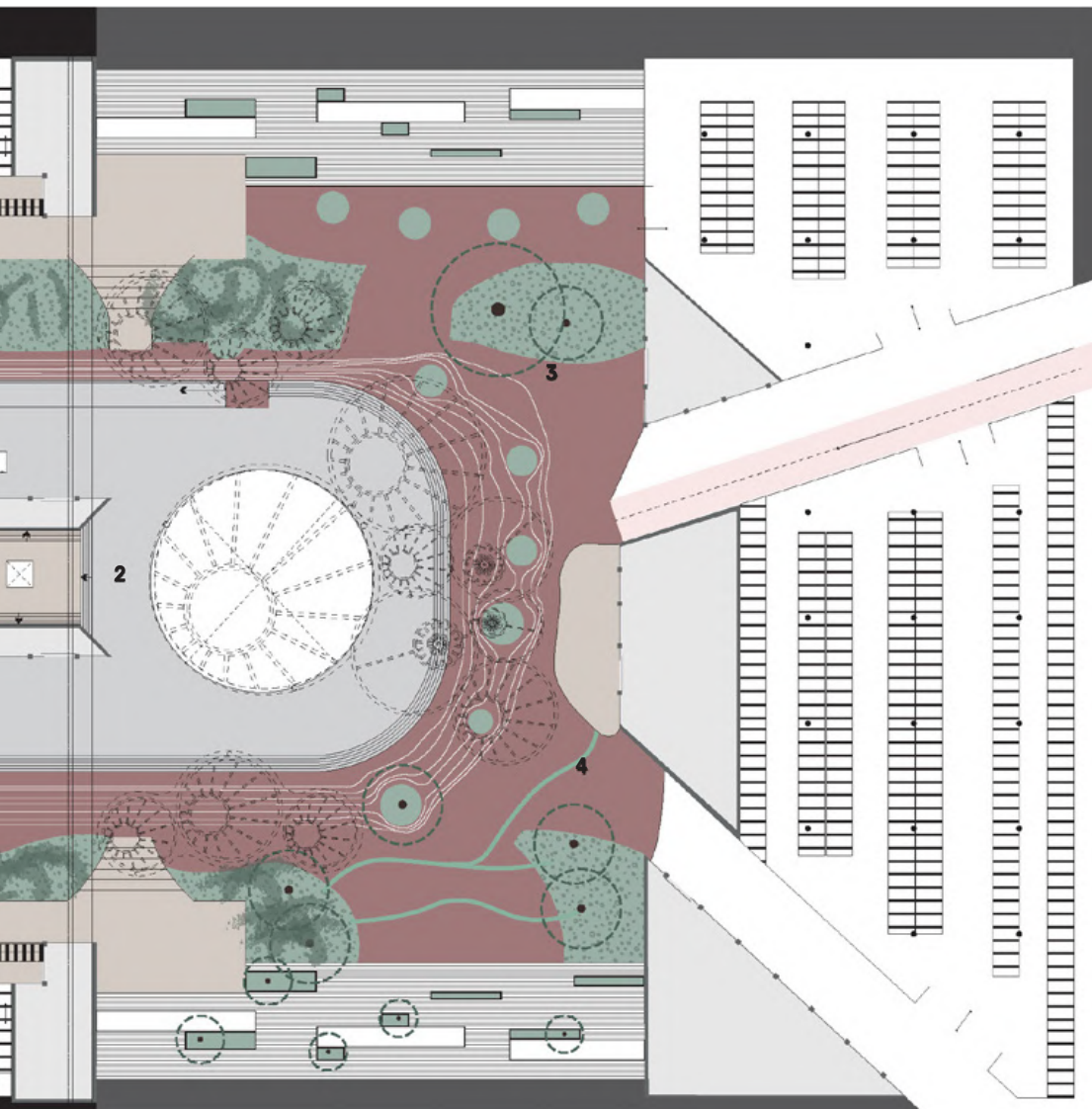

Design Project introduction

Plan Organisation

The design of the intermediate metro level is based on three ideas. The first one is the easy access and functional flow of people in case of both large and small crowds. In order to achieve that, the plan is organised in three zones. The first zone is the one for pedestrians that move vertically, from the urban plaza to the metro platform. The second zone is for the people who want to pause and enjoy the green of the space. This area offers benches and areas for social interaction and relaxation. The third zone is the zone for cyclists who either want to cross the station from east to west, or they want to park their bike and get the metro.

The second idea of the intermediate level is to be a liveable space, where people want to spend time, and not just as a metro station. In order to achieve this, a lot

of bushes and short vegetation dominate the second zone area where people are supposed to slow down and enjoy the nature. This is a place for socializing, working or relaxing by yourself. In order for this to be possible, large openings that bring natural daylight into the space has to be made. In this way, architecture and nature come together and form a pleasant space.

The third idea of this design is this level to function as a connector between the eastern and the western neighbourhood. The level is a bicycle bath and offers quick access from the one side to the other without entering the urban plaza. The eastern entrance of the path connects the intermediate level with the bike parking. The eastern entrance of the path connects the intermediate level with the neighbourhood.

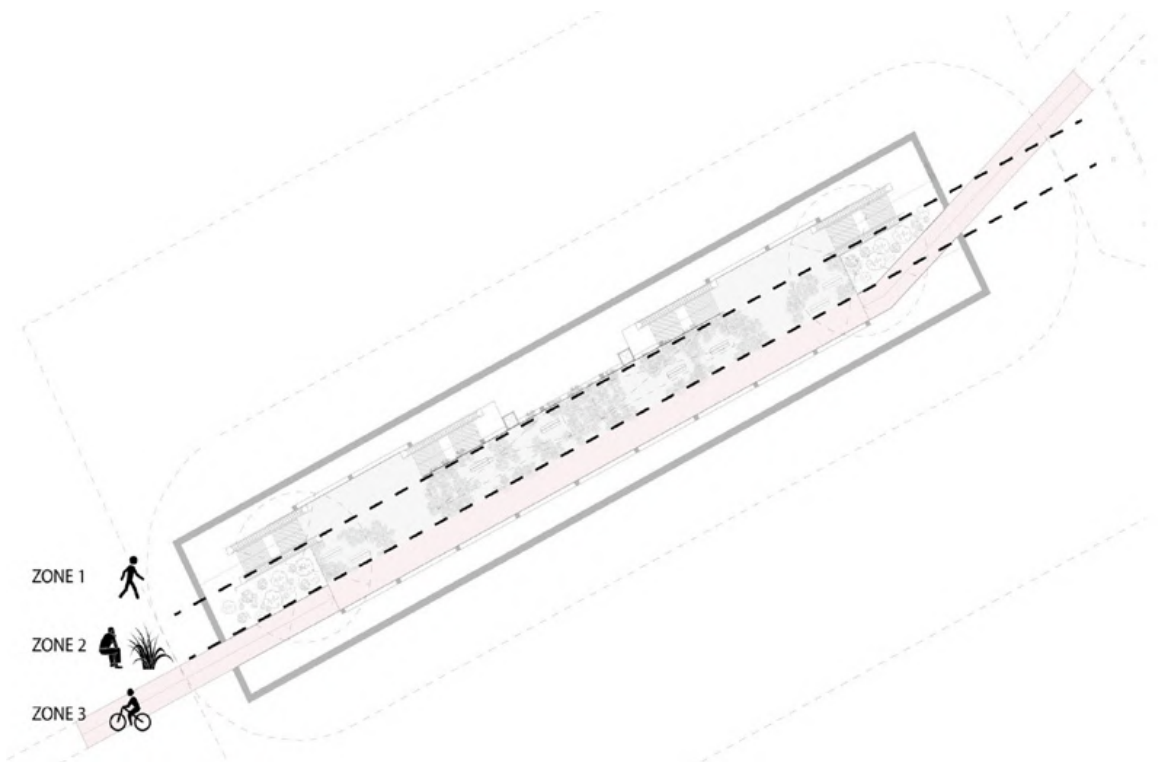

Intermediate Metro Level
Diagram



Intermediate Metro Level
Illustration

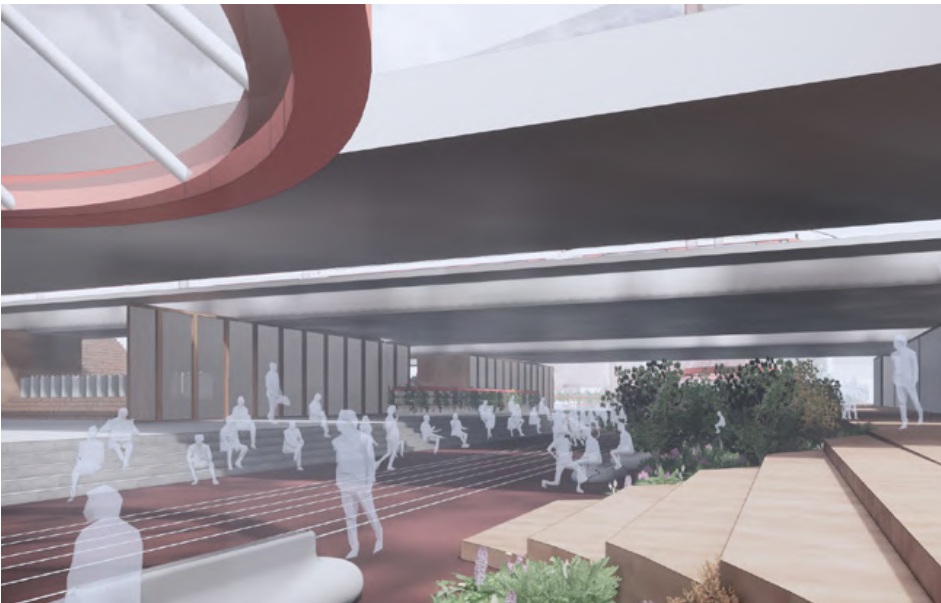

Urban Plaza south passage
Illustration

Analysis Design of Landscape

The area is separated by the train tracks cutting through the site. On the east side, it's characterized by its industrial expression with concrete, large surfaces of asphalt and metal represented through the stadium. A contrast to that is the west side with a soft expression through the green lawns and tall trees which create a so called "green edge" separating the landscape in fragments and scale which enhance the emptiness. It has been decided to keep the existing green park and use it to take up the expected crowd from the future plan of the area which is set to become the European hub for sports. As it is now, the green area isn't used and has no added value to the neighborhood. To balance out the site which is heavy activated/ attractive on the east by the future OMA development, the goal is to create a landscape that invites people over to the west side.

The landscape tries to tackle the fragmentation caused by the train tracks, by placing tram and buses on the west side of the tracks. Through this rearrangement, some distance is created in-between the different infrastructures for better crowd control of the area and also to activate it. It is suggested to open up the so-called "green edge" and make openings and a more human scaled nature. Some of the existing trees will be kept and rearranged in the new development. The *greenification* will create a green path from the neighborhood through the urban plaza and reach down to the metro platform to combine and connect the fragmented area.

The form of the landscaping is inspired from the movement in the area. As the urban plaza is placed -6m under ground level, the park tackles this level difference by creating a stepped landscape. Like the rice fields in South East Asia, this level will be filled with rain beds taking up the stormwater. The stepping system will also create a closer human scale with small niches for people to occupy. A part of the redevelopment is to include water retention solutions. To relieve the sweage, the landscape is designed with rain beds that can handle surges whilst the level difference between the urban plaza and ground 0 is utilized to withstand larger amounts of rain. The urban plaza is design with level difference to prevent flooding the station.

The pavement in the landscape will be a combination of pervious and impervious concrete. Pervious concrete is a recycling material, and it is chosen because of its environmental benefits. By using pervious concrete, the open cells in the material purifies the rain water as it percolates through. Because of its porosity, it operate well together with vegetation as it gives the plants root access to the water. While normal concrete will be used due to its strength and durability at places which get more stressed such as the sharp edges.



Collage of furniture in landscape
Illustration



Collage of metro platform
Illustration

Metro Platform

Because the platform is an underground environment, it is needed to brighten up the atmosphere. Light openings from ground 0 to the platform in -23m are therefore cut out and will also serve as natural ventilation. To make the underground space feel as wide and open as possible, the illusion of the intermediate space as a flooding level is given to perceive the whole underground metro station as one large volume.

The metro platform acts as a place for people to transit from and to the metro. It is a level of constant movement and change of people. It's important to create clarity through the overall design. The design aims for a clear expression and for people to easily navigate and use the platform. As human, we're not familiar with the underground environment. Therefore, the focus is to create recognition by likening the platform to a traditional pedestrian street. By bringing the green stroke from the park down to the platform, a more vivid

variable is added through lights, materials and nature as a contrast to the harsh underground conditions. For vegetation to grow, light is essential. Natural light will penetrate from the upper layer, through openings in the intermediate level and the ground level. The vegetation is placed under each light source to receive the most light. Two plant species are selected which work with low lighting conditions. *Ficus nitida* and *Bucida Buceras* are the chosen evergreens which can't tolerate direct light and have minimum needs for natural light compared to other species.

A deep root watering system is used in the tree pits to ensure the trees are watered adequately. This system carries the water down through pipes directly to the trees' roots. The pipes are connected to a water tank to keep the maintenance low.

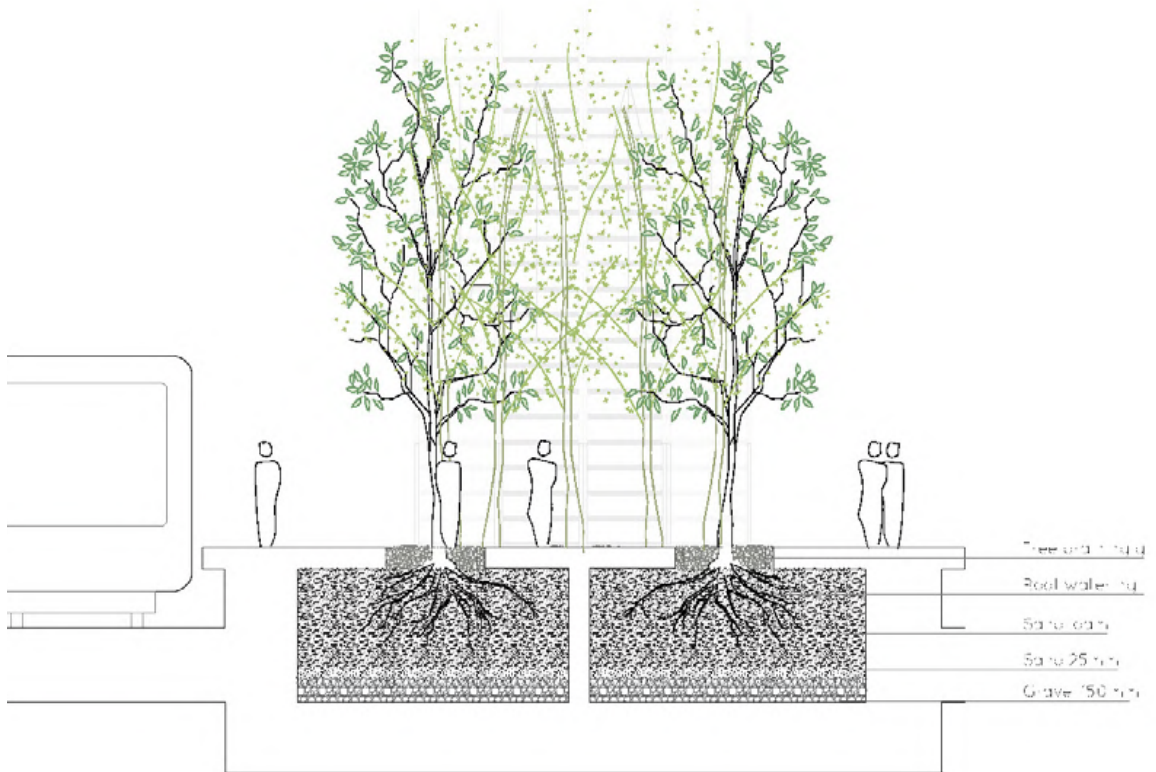

Section of plant beds in the metro platform

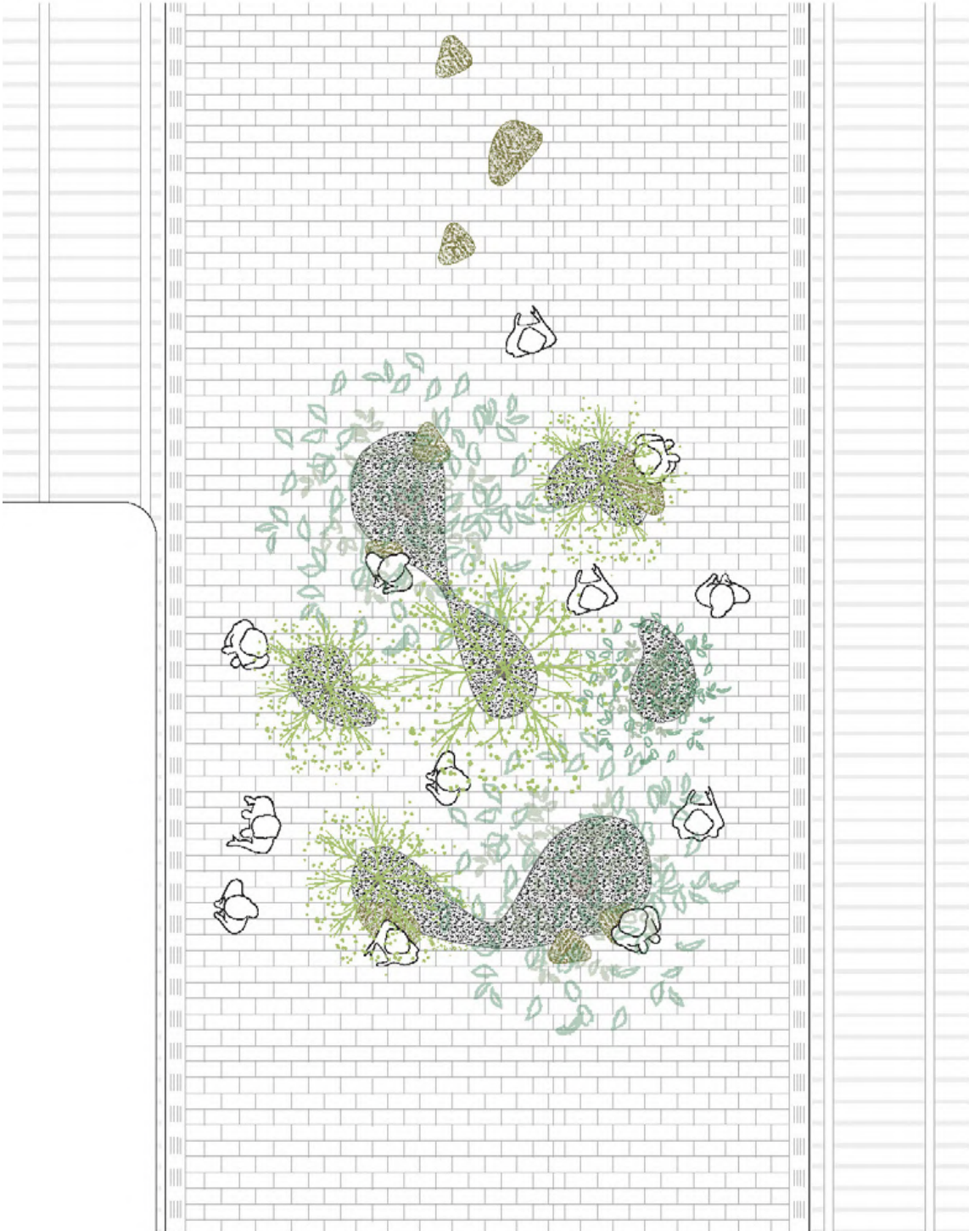

Plan of metro platform

Concept & References

Use of Textile and Light in Architecture

The roof of the Rotterdam Zuid station aims at being a light structure, covering the urban plaza and sheltering the visitors from rain. At the same time, it wants to allow sunlight to penetrate in order to reach the public space on the open -1 urban level (plaza), but also the further underground levels through the round opening that links all levels. In addition, the general concept of the station is that of being a connection hub, without emerging as a solid building from the ground in order to avoid competition with the already existing landmarks (the old and new stadium). The solution that responds to all needs seems to be a lightweight structure that supports a transparent, light, tenuous, inconsistent material, able to shelter but provide enough sunlight. This is where the idea of textile came from. Textile is a light, but also strong, material, adaptable in shape and stretchable, suitable for this purpose. The concept is the expansion of space, that extends and shapes the roof. Another important element that could be considered in the design is soft light, or the light that doesn't come directly from the sun, but is reflected and diffused by architectural elements. This has been experimented for long time by important architects (from Louis Khan to Renzo Piano), and there are great examples of this which it would be possible to draw from. For instance, in the Daylight House, by Takeshi Hosaka Architects, light comes from the roof but is filtered through round shape small vaults. In the Viipuri Library, Alvar Aalto studies sun rays angles and skylights' depth in order to prevent direct sunlight on the visitors' books at any time of the day in all seasons.

Modular system: In order for the design to be adaptable, for different situations, but also in time, it would be useful to apply a modular system solution. The choice of the round module could match the overall design, that tries to implement and organic natural shape into the urban plaza, orienting the design toward a dynamic movement, that could better be reflected by a round shape rather than a strict rectangular grid. Moreover, the round shape recalls the plaza opening and the circular ramp sinking into the ground.

Preliminary Design

How to variate and combine the concept

Variations

The module is not an un-adaptable constraint, but rather a starting point through which it is easier to produce more combinations. First of all, the modules can change in dimension in order to accommodate the needs of different spaces. Moreover, the modules can be combined together to create a different shape solution. Overall, the module is just a way to keep the design, and its feasibility, under control, still allowing space to be the catalyst to shape the structure in a way that it suits it.

Variation/Transparency

The first variation implies use of different materials. Different modules, that are the same in shape and maybe dimension, could be varied by choosing different materials that have a different way of letting light penetrate them: some are more transparent, and let the sunlight in, some are opaque and create a stronger shadow. Some others could be characterised by a opaque material with a filtration pattern, that creates interesting shadows in the public space.

Variation/Oculus

The shape of the oculus could change according to the needs of the space. In some areas, sunlight should be captured and let into the space, but sometimes it's required to prevent this. Where the displays are, the direct sunlight could make it hard to read, or in the waiting areas it could bother the visitors. This is way it would be useful to implement a modular scheme that provides soft and diffused light, rather than direct sun rays. This can be accomplished by introducing a solid cylinder into the oculus, that could reflect and diffuse light without letting in direct sunlight.

Variation/Structure

The shape of the module allows to have different kind of structures according to different spaces. The first structure is a more standard beams and columns structure, relying on some columns to carry the weight of the structure. As previously stated, the module is made of a lightweight structure: this allows also to consider another kind of support system, that could be associated with a umbrella structure. In this case, the structure is concentrated in one spot, and the number of columns is reduced to one.

Combination

It is possible to combine the modules into an organic shape. The asset of the modular roofing is that it can be shaped by space and by needs or requirements, and it becomes a very specific roof that could not be, if taken out of the context.

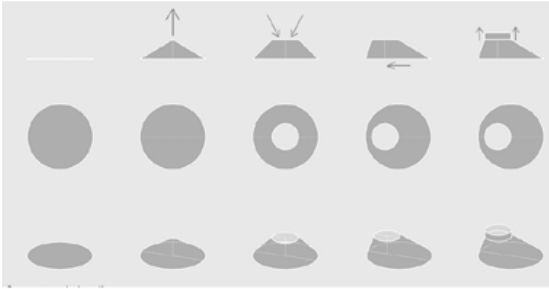

Pezo von Ellrichshausen, Vitra Pavilion, Venice Biennale 2016



Concept
Source: ArchDaily

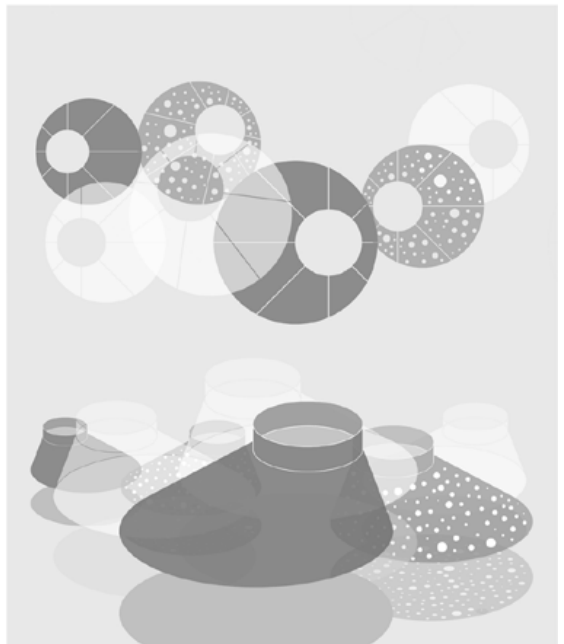
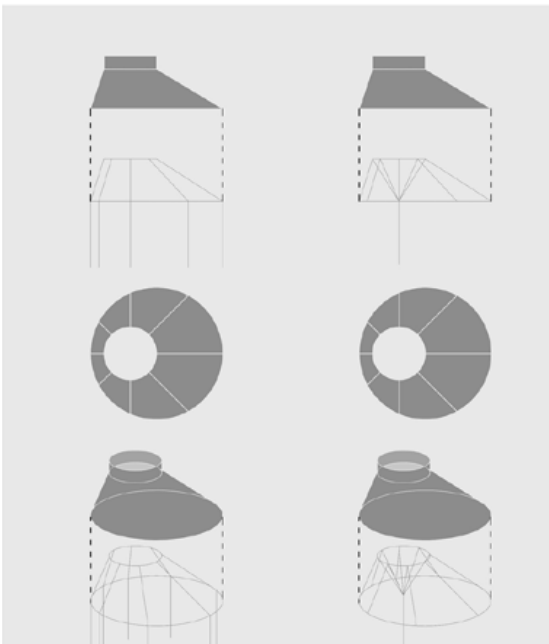

Final Design

Diagrams, Plans and Sections

Taking the research into account, the final design tries to respond to the different inputs given by the analysis. The position of the roofs is determined by some parameters emerged from the initial reflections. First of all, the travellers' flows, that might be influenced by the strong centrality and symmetry of the urban plaza, that features two parallel sides characterised by the round openings, and the train tracks that cover and shelter the middle part of the public space. Therefore, given the assumption that most of the visitor would flow through the public space following the central part of the plaza, the idea for crowd control is to create an alternative path, along the "sports" oval area, on a slightly lower level, by sheltering the north and south side of the urban space. By creating this covered route, people could have a choice in following either the central path in direction of the train station entrances, under the railway, or to slide aside cutting through in direction of the south or north exit point of the under-level.

Secondly, the roof are a subtle indicator of the routes to take: the largest umbrella is placed on the metro opening, pointing out the main direction to access the lower levels. In addition, the largest metal roofs are placed according to the position of the stairs and escalators leading underground. In this way, the metro access is well sheltered and well indicated by the umbrellas.

The covers are joined in clusters; some of them, with the umbrellas merged together, for the practical reason of reducing the number of columns, and for the ideal reason of creating a path towards the centre, are placed along the sports area, where visitors and locals could stop by, sit on the steps or benches, and have a look at people training. The rest of the umbrellas are standing in specific spots, close to the openings and where the train and metro info points, the shops, and the bike park entrance are. This creates some strategic areas in the urban space, where the visitors and local could gather and interact with each other.

In the central clusters, bigger umbrellas feature the one column structure, that integrates benches and small tables. In addition, the smaller umbrellas placed close to the metro entrances have a three column structure, and on each column a screen with a timetable display could be placed in order to facilitate the metro entrance. Furthermore, the plan shows the train track roof, that could be a textile structure, with a much bigger oculus in the centre, bringing direct sunlight on the tracks but also being directly above the railway to prevent raining on the platform.

Another important aspect of the location of the roofs is given by the analysis of the sun path. As shown in the diagrams, the tracks pose a great challenge to this plaza, as they completely shed the central part. The lightweight structure of the roof is designed and located so that they would not contribute to shading the underpass. In fact, it is important that the underpass stays as bright as possible. Therefore, the roofs do not closely approach the tracks, but they leave an in-between space that acts as a light-carrier to the underpass.

Moreover, as conveyed by the shadow diagrams, that are simplified but drawn according to the right sun angles in the different seasons, the roofs are designed so that in summer they would create a larger central shadow surface, whereas in winter the shadows would merge and leave more space to sun rays in the urban central areas.

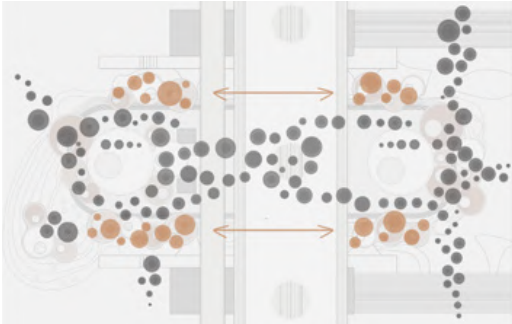

Flow Diagram



Metro Entrances



Sport Shelters

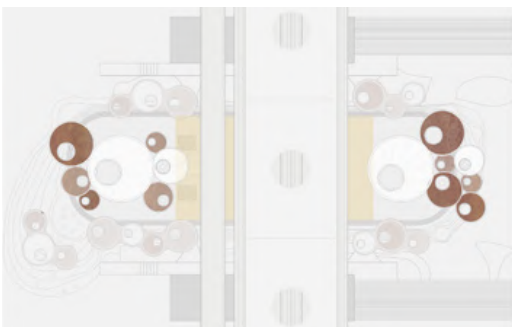

Strategic position

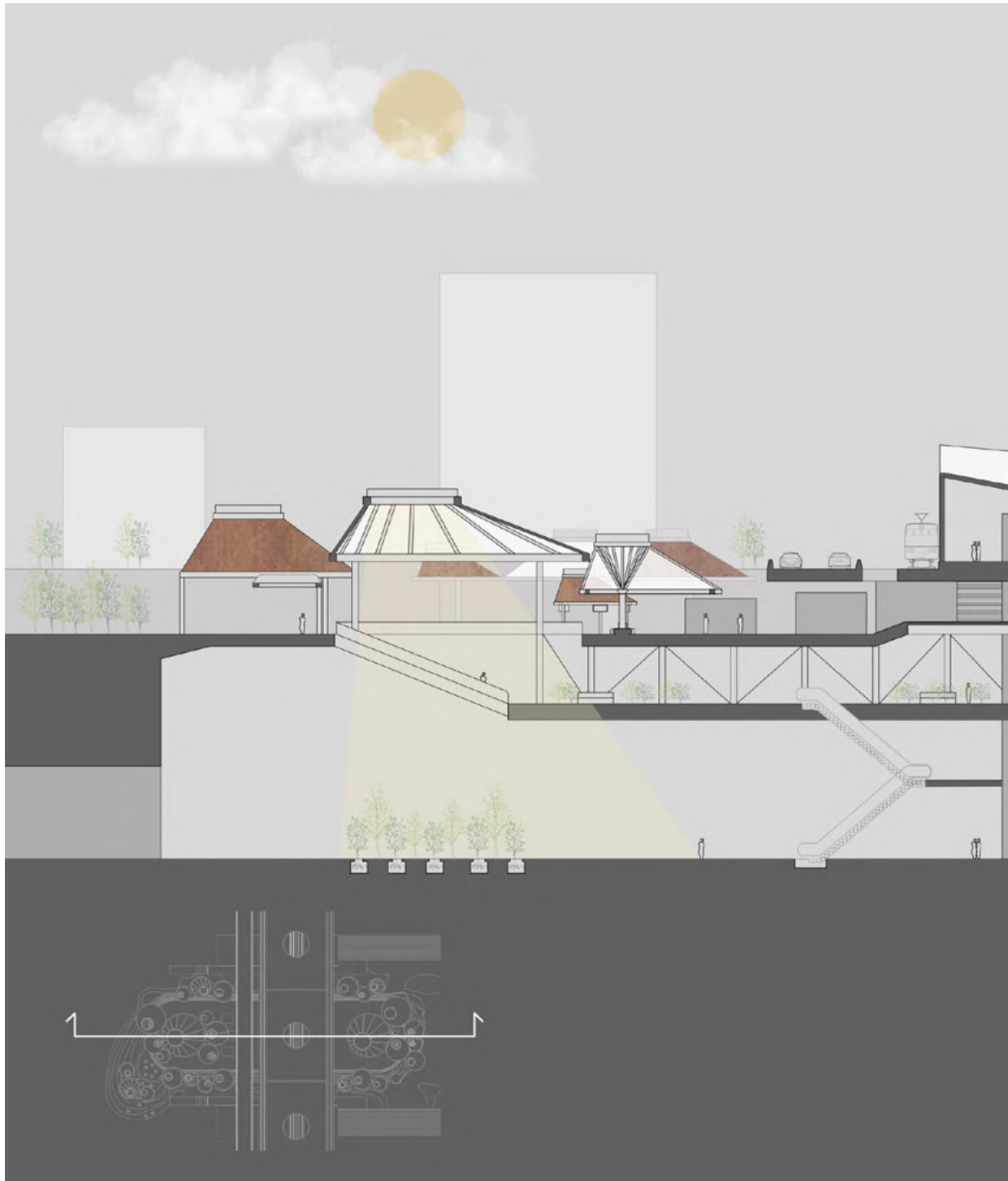



BIO's WRITERS & CONTRIBUTORS

B

Nacima Baron
University Gustave Eiffel Paris

Nacima Baron is human geographer, working at the nexus of social science and territorial policies. She is Full Professor at the Ecole d'Urbanisme de Paris and member of the LVMT laboratory. She is responsible for the Railway Stations Chair at the Ecole des Ponts and for Axis 3 in the ISlTe Futurs Urbains MUTANDIS research programme on the governance of innovative mobility solutions in peri-urban areas.

Olindo Caso
TU Delft

Olindo Caso achieved his PhD in 1999 at Delft University of Technology. He makes part of the 'Complex Projects' group at the Department of Architecture, TU Delft, and coordinates the research group 'Architecture and the City'. Main education and research themes relate to the architecture of the infrastructure for culture and for mobility. He is the author of many (international) publications.

Kees Kaan
TU Delft; AMS Institute

Kees Kaan is founding partner of KAAAN Architecten. He is Professor of Architectural Design, head of Complex Projects Chair and Chairman of the Architecture Department at the Faculty of Architecture and the Built Environment at TU Delft. He has built up a national and international portfolio of architecture, urban planning, and interior design projects. He is an international lecturer and sits on several juries and boards, both in the Netherlands and abroad. Various books and exhibitions have been dedicated to his body of work.

Wouter Kamphuis
Gemeente Rotterdam

Wouter Kamphuis operates as a designer and strategic advisor for the municipality of Rotterdam. He obtained his master's degree in architecture at Delft University of Technology. His studies contribute to regional policy and planning for the new river crossing and metro lines by positioning infrastructure and its impact in Rotterdam's spatial context.

Yagiz Soylev
TU Delft

Yagiz Söylev is an architect and researcher. He received his Master degree in architecture with honours from TU Delft in 2018. He takes part in the teaching and research activities at TU Delft, Department of Architecture. He was the associate curator of the Pavilion of Turkey, in the 16th International Architecture Exhibition, la Biennale di Venezia in 2018. His work has been displayed in international exhibitions such as Istanbul Design Biennial and Shenzhen UABB.

Manuela Triggianese
TU Delft; AMS Institute

Manuela Triggianese is Assistant Professor at Delft University of Technology at the Department of Architecture, section of History & Complexity. She achieved her PhD in 2014 at IUAV and she worked as visiting researcher at the Beijing Technical University. She is member of 'Architecture and the City' (Department of Architecture), 'Smart Urban Mobility' (AMS Institute) and 'Future(proof) Urban Infrastructure' (Deltas Infrastructure Mobility Initiative) research groups.

Marc Verheijen
Gemeente Rotterdam

As architect of the City of Rotterdam, Marc Verheijen combines traffic engineering with architecture. His projects vary in scale and abstraction, from masterplan to building. Recently he wrote the book 'Infrastructure, infrastructure by design' as an invitation for debate on the quality of public space. As architect within the engineering office of the municipality of Rotterdam he realized a wide range of infrastructure related buildings: parking's, hubs, stations, bridges and viaducts.

Alice Lee, Anna Shishkina, Bethany Kiss, Birte Zacharias , Coen Jager, Diego Toribio Álvarez, Ervin Muhovic, Federica Longoni, Gerjan Agterhuis, Giannis Nikiforou, Hannah Zhu, I-Hsuan Lee, Isaac Vaarzon Morel, Ian Omumbwa, Izk Chan, Jasmin Goldberg, Jemina Lai, Jesse Verdoes, Julia Linde, Julianne Guevara, Julka Veerman, Kees Kaan, Laura Sacchetti, Lorenzo Bondavalli, Maciej Moszant, Manuela Triggianese, Matteo Gumirato, Maxwell McGrath, Marc Verheijnen, Maya de Ridder, Nacima Baron, Nigel Flanagan, Olindo Caso, Qi Hao, Rogier Tamminga, Romy Weeteling, Siddharth Agarwal, Sofia Pavlova, Su Gu, Tamas Dongo, Wessel Herrewijnen, Wouter Kamphuis, Yagiz Soylev

ISBN 9789463663830



9 789463 663830