

« Individually controlled noise reducing devices to improve IEQ in classrooms of primary schools »

Dadi Zhang

Individually controlled noise reducing devices to improve IEQ in classrooms of primary schools

Dadi Zhang



A+BE | Architecture and the Built Environment | TU Delft BK

20#10

Design | Sirene Ontwerpers, Rotterdam

Cover image | #

ISBN 978-94-6366-287-1

ISSN 2212-3202

© 2020 Dadi Zhang

Digital version freely available at abe.tudelft.nl

All rights reserved. No part of the material protected by this copyright notice may be reproduced or utilized in any form or by any means, electronic or mechanical, including photocopying, recording or by any information storage and retrieval system, without written permission from the author.

Unless otherwise specified, all the photographs in this thesis were taken by the author. For the use of illustrations effort has been made to ask permission for the legal owners as far as possible. We apologize for those cases in which we did not succeed. These legal owners are kindly requested to contact the publisher.

Individually controlled noise reducing devices to improve IEQ in classrooms of primary schools

Dissertation

for the purpose of obtaining the degree of doctor
at Delft University of Technology,
by the authority of the Rector Magnificus Prof.dr.ir. T.H.J.J. van der Hagen,
Chair of the Board for Doctorates
to be defended publicly on
Monday, 13 July 2020 at 10:00 o'clock

by

Dadi ZHANG
Master of Engineering in Heating, Gas Supply, Ventilating and Air Conditioning
Engineering,
University of Science and Technology Beijing, China
born in Beijing, China

This dissertation has been approved by the promotor.

Composition of the doctoral committee:

Rector Magnificus,	chairperson
Prof. dr. ir. P.M. Bluyssen	Delft University of Technology, promotor
Dr.ir. M.J. Tenpierik	Delft University of Technology, promotor

Independent members:

Prof.dr. L.C.M. Itard	Delft University of Technology
Prof. dr. ir. P.M.A. Desmet	Delft University of Technology
Prof.ir. M.F. Asselbergs	Delft University of Technology
Prof. dr. M. Rychtarikova	Katholieke Universiteit Leuven, Belgium, and Slovak University of Technology, Slovakia
Dr. H.T. Remoy	Delft University of Technology

This research was funded by CSC, Chinese Scholarship Council of China, which is thankfully acknowledged.

Preface

Why am I interested in working on the IEQ of classrooms?

My interest in IEQ, and especially in acoustics, began almost 20 years ago. Since I was a school child, I was very sensitive to sound, and the noise created by my classmates always disturbed me. But at that time, nobody understood me; the teachers and my parents thought I was simply not concentrating enough. Therefore, I had to bear this annoyance all alone until I went to university. I have often thought how wonderful it would be to have a quiet learning environment.

How did the research start?

Thanks to the hyper-competitive national college entrance examination in China and the special major arrangement in universities, I was reallocated to a major I had never heard from before - “building environment and equipment engineering” at the University of Science and Technology Beijing. Now looking back, that twist of fate feels like destiny. During my four years of undergraduate education and two years of graduate research in the field of indoor environment, I obtained basic knowledge about IEQ and came to understand that I am not the only one who has been bothered by problems in this area. The potential impact of IEQ on occupants’ comfort, health and performance inspired me to continue this line of research.

Then, by a stroke of good luck, I found an opportunity to conduct PhD research at the Delft University of Technology on the IEQ of classrooms. With the help of Professor Philomena M. Bluysen, who later became my promotor, I got the scholarship provided by Chinese Scholarship Council (SCS) to support my four-year PhD study abroad.

What is this research about?

This research aims to improve the IEQ of primary school classrooms and to make every child feel comfortable. At the beginning of the research, all the IEQ aspects, including indoor air quality, thermal quality, visual quality and acoustic quality,

were studied as a whole in 54 classrooms of 21 Dutch primary schools. It was found that children in the same classrooms differ from each other in terms of their IEQ perceptions, preferences and needs. Based on that, six children's profiles were identified, and these profiles implied that future IEQ improvements should focus on the individual level. In addition, this field study showed that noise was the biggest IEQ problem for schoolchildren, with 87% of them reported to be bothered by it (just as what I experienced as a child). Therefore, the latter part of this research focused only on acoustics. Many experiments and simulations were performed not only to demonstrate the impact of noise but also to find effective solutions to improve the acoustical quality in classrooms. Ultimately, an individually controlled noise-reducing device was designed, prototyped, and tested. Although there were still shortcomings in the functionality and appearance of the current prototype, the positive results obtained from the simulations, measurements, and children's feedback confirmed its potential to create better acoustics in classrooms. Overall, the results of this research suggested that utilizing individually controlled devices is the most effective way to improve both acoustical quality and children's acoustical perceptions in classrooms. A new era of IEQ control is coming!

Acknowledgements

This research was funded by the China Scholarship Council (SCS). Thank you, my dearest motherland – China!

During the last four years, I have received lots of support from my promotors, colleagues, friends, and family members. Without their help, this research could not have been completed. For some of them, I would like to express my gratitude in particularly:

First and foremost, I need to convey my best thanks to prof. Bluysen, my promotor, for providing me the opportunity to conduct this PhD research at TU Delft, for guiding me in the academic research, for always replying me very quickly, and for giving me all the suggestions to make me a better researcher. I know without your help I cannot finish my PhD within four years.

The same sincere thanks also go to my second promotor, Martin Tenpierik, who is the most gentle and refined people I have ever met. To be honest, I am not a confident person, thanks to your affirmation and encouragement, I have got the faith to keep going. Also, thanks to your excellent and professional guidance on acoustics, without which I could not find the final solution presented in this thesis.

Besides, I would like to express my gratitude to my previous daily supervisor, Stanley Kurvers, for helping me to conduct the field study, and to my previous second promoter, David Keyson, for helping me to design the individually controlled device.

Also, I would like to thank my master supervisor, Jing Liu, for introducing me to the world of academic research, for sharing your positiveness, knowledges, and experience with me, for all the trust, encouragement and freedom that you give me!

Apart from my promotors and supervisors, I would like to thank the rest of my defence committee: Prof. dr. M. Rychtarikova from Katholieke Universiteit Leuven, Belgium, Prof.dr. L.C.M. Itard, Prof. dr. ir. P.M.A. Desmet, Prof.ir. M.F. Asselbergs and Dr. H.T. Remoy from Delft University of Technology. Thank you for your kind and insightful feedbacks and questions.

I would also like to thank my colleagues: Thank you, Marjolein, for teaching me how to use SPSS from the beginning, for helping me translate the questionnaires, for giving me so many furniture to my new and bare apartment, for being so patient and friendly to me. Thank you, Marco for helping me check my English, for sharing me your analysis method, for getting me involved in your research. Thank you, Tatiana, for always being so kind with me, for all your life suggestions, for all the smell and hugs. Thank you, Annemarie, for providing me the opportunity to conduct the hospital inspections with you, for helping me to identifying the children's handwritings, for all the pleasant chats with you. Thank you, Dong, for selfless offering me the useful job search advice, for recommending me the delicious restaurants, for encouraging me all the time. Thank you, Vero, for your great editing job on this thesis. Thank you, Nana and Tiantian, two of my best friends here, for your unconditional help, I will not forget any dinner eat with you!

Thanks to all the secretaries for helping me dealing with all the trifles and for making me work much easier! Here, I would like to express my special thanks to Bo, I really appreciate all your help in both my research and my life! Thank you for all the suggestions, the dumplings, the paopaos, and, of course, the drinks!

Many thanks to all my friends for making my life so wonderful! Thanks, Jesmine (Yue) for spending almost all your holidays and bonus to come to visit me at least once a year, for understanding all my joy and sorrow, for the 27 postcards that you sent to me from all over the world; Thanks Xiaowei, for helping me when I need it most, for drawing the beautiful cover of this thesis. Thanks Q for always bring me the positive energy and for encouraging and comforting me when I was sad; Thanks Lu, my 'better half', for being my best source of inspiration and courage, you are my role model!

Finally, thanks to my family for your selfless love! Thanks, mom, for helping me renovating my poor bare apartment from zero, for helping me installing the ICND in that super-hot summer, for all the delicious meals you cooked for me, for travelling so many countries with me, for showing me what is the real kind and optimistic! Thanks, dad, for always supporting me, both spiritual and material, without any condition, for introducing me to running and cycling! I will never forget the first Marathon that we have ever run together and the cycling tour around the Qinghai Lake and the hiking crossing the dissert. All of these taught me strong and brave. Also, thanks to my grandparents, uncles, aunts, and cousins, your love is my strongest support.

A very special tanks is given to my boyfriend, Ke, for accompanying with me through the whole journey, for making me want to be a better myself, for tolerating all my moods and for persistence in this relationship, for always loving me!

谢谢我最亲爱的爸爸妈妈！

Contents

List of Tables	17
List of Figures	18
List of Abbreviations	21
Summary	23
Samenvatting	27
总结	31

1 Introduction 33

1.1	Problem statement	33
1.2	Scientific context	34
1.3	Research aims and questions	35
1.4	Research methods	38
1.5	Thesis outline	40
1.6	Research contribution	43

2 Literature review 47

2.1	Introduction	48
2.2	Methods	48
2.3	Results	50
2.3.1	Current condition of IEQ in classrooms	50
2.3.2	The impact of IEQ on students' health, comfort, and performance	51
2.3.3	Conventional solutions to improve IEQ	53
2.3.4	Individual control	54
2.3.5	The effect of individual control	55
2.4	Discussion	56
2.4.1	Problems of the IEQ in primary school classrooms	56
2.4.2	What could be an effective solution?	57
2.5	Conclusion	58

3 **Actions of primary school teachers to improve the indoor environmental quality of classrooms in the Netherlands** 65

- 3.1 **Introduction** 66
- 3.2 **Methods** 69
 - 3.2.1 Data collection 69
 - 3.2.2 Data analysis 71
- 3.3 **Results** 72
 - 3.3.1 Descriptive analysis results 72
 - 3.3.2 Relationship analysis 77
- 3.4 **Discussion** 81
 - 3.4.1 Difference between traditional schools and non-traditional schools 81
 - 3.4.2 Limitations and suggestions for future research 83
- 3.5 **Conclusion** 83

4 **Clustering of Dutch school children based on their preferences and needs of the IEQ in classrooms** 101

- 4.1 **Introduction** 102
- 4.2 **Methods** 104
 - 4.2.1 Data collection 104
 - 4.2.2 Data analysis 105
- 4.3 **Results** 107
 - 4.3.1 Descriptive analysis 107
 - 4.3.2 Correlation analysis 109
 - 4.3.3 Principal component analysis 112
 - 4.3.4 Two-step cluster analysis 112
 - 4.3.5 Description of clusters 113

4.4	Discussion	122
4.4.1	Existing problems in classrooms studied	122
4.4.2	School children's profiles	123
4.4.3	ICDs as a solution?	124
4.4.4	Limitations	124
4.5	Conclusion	125
5	Impact of different acoustic conditions on school children in the Netherlands	129

Part I / Interaction effect of background sound type and sound pressure level on children of primary schools in the Netherlands

5.1	Introduction	132
5.2	Literature review	133
5.2.1	Impact of external noise	133
5.2.2	Impact of internal noise	133
5.2.3	Impact of music	134
5.2.4	Academic performance tasks	135
5.3	Method	136
5.3.1	Experimental setup	136
5.3.2	Data analysis	140
5.4	Result	142
5.4.1	Performance test	142
5.4.2	Sound evaluation	142
5.4.3	Influence assessment	143
5.5	Discussion	143
5.5.1	Impact on children's performance	145
5.5.2	Impact on children's sound evaluation	147
5.5.3	Impact on children's influence assessment	149
5.5.4	Relation to children's real classrooms	150
5.5.5	Limitations	151
5.6	Conclusion	152

Part II / The effect of acoustical treatment on primary school children's performance, sound perception, and influence assessment

5.7	Introduction	159
5.8	Methodology	160
5.8.1	Study design	160
5.8.2	Facilities	161
5.8.3	Performance task	162
5.8.4	Procedure	162
5.8.5	Data management and analysis	163
5.8.6	Ethical aspects	164
5.9	Results	164
5.9.1	Participants	164
5.9.2	Descriptive	165
5.9.3	Comparison in different background sound conditions	167
5.9.4	Children's preference of these chambers	171
5.10	Discussion	171
5.11	Conclusions	172

6 Individual control as a new way to improve classroom acoustics: a simulation-based study 175

6.1	Introduction	176
6.2	Method	178
6.2.1	The classroom layout	178
6.2.2	Acoustic model	180
6.2.3	Settings of simulations	183
6.2.4	Lombard effect	184
6.3	Validation of the simulations	187
6.4	Results of the simulations	191
6.4.1	Instruction situation (without Lombard Effect)	191
6.4.2	Self-study situation without Lombard effect	194
6.4.3	Self-study situation with Lombard Effect	196

6.5	Discussion	199
6.5.1	Effect of the classroom-level improvement	200
6.5.2	Effect of the individual-level improvement	200
6.5.3	The classroom-level improvement vs. individual-level improvement	201
6.5.4	Simulation involving Lombard Effect	201
6.5.5	Limitation and strength	202
6.5.6	Future studies	202
6.6	Conclusion	203
7	A child-centred experiment to test a new individually controlled acoustic improvement device	207

7.1	Introduction	208
7.2	Method	210
7.2.1	Experimental design	210
7.2.2	Data Analysis	214
7.2.3	Measurements	214
7.2.4	Simulation	216
7.2.5	Ethical aspects	218
7.3	Results	218
7.3.1	Participants	218
7.3.2	Descriptive analysis results	218
7.3.3	Relationship analysis results	220
7.3.4	Content analysis results	221
7.3.5	Measurements	224
7.3.6	Simulations	225
7.4	Discussion	226
7.4.1	Acoustic problem in classrooms	226
7.4.2	Feedback from children	226
7.4.3	Effect of the ICND on room acoustics	227
7.4.4	Application potential of ICNDs in real classrooms	228
7.4.5	Possible improvement of the current device	228
7.4.6	Limitations and future studies	229
7.5	Conclusion	229

8 Conclusion 235

- 8.1 Introduction 235
- 8.2 Answers to the research questions 236
 - 8.2.1 sub-questions 236
 - 8.2.2 main question 243
- 8.3 Limitations of the research 244
- 8.4 Practical implications 245
- 8.5 Future research 247

Curriculum Vitae 251

List of publications 253

List of Tables

- 2.1 The keywords used to search literatures. 49
- 3.1 Difference of frequency of teachers' actions between different school types. 75
- 3.2 Difference of frequency of children's requests between different school types. 76
- 3.3 Comparison of children's perceptions between two groups of classrooms with different frequencies of children's requests (less than once a day vs. at least once a day). 78
- 3.4 Relationships between children's requests and teachers' actions. 79
- 3.5 Comparison of children's perceptions between two groups of classrooms with different frequencies of teachers' actions (less than once a day vs. at least once a day). 80
- 4.1 Correlations between school children's comfort perceptions and their preference of ICDS. 110
- 4.2 Correlations between school children's comfort perceptions and importance indexes. 111
- 4.3 Cluster input with predictor importance. 113
- 4.4 Characteristics of school children in different clusters. 114
- 5.1 Estimated RT^* of the chamber. 137
- 5.2 Characteristics of children in different experiment conditions. 140
- 5.3 Results of the two-way ANOVA^a. 143
- 5.4 Comparison between children who were bothered by noise in their classrooms and children who were not. 151
- 5.5 Comparison of children's test scores and evaluation scores between Chamber A and B. 167
- 5.6 Comparison between chamber A and chamber B for the different conditions. 168
- 6.1 Corresponding relation between the STI value and speech intelligibility evaluation. 177
- 6.2 Absorption and scattering coefficients of different materials. 181
- 6.3 The value of K_0 . 186
- 6.4 Comparison of reverberation Time resulting from measurements and simulations. 190
- 6.5 General acoustic simulation results in the instruction situation. 191
- 6.6 General acoustic simulation results in the conversation situation. 194
- 6.7 General acoustic simulation results in the conversation situation. 199
- 7.1 Absorption and scattering coefficients of different materials. 216
- 7.2 Result of the descriptive analysis. 219
- 7.3 Result of the Chi-squared analysis between the questions. 221
- 7.4 The measurement results (no tables and desks). 225
- 7.5 The simulation results 226
- 8.1 Summary of the six profiles of children identified by this study. 241

List of Figures

- 1.1 Research questions and aims of this study. 37
- 1.2 Methodology scheme of this study. 39
- 1.3 Outline of this thesis. 42
- 3.1 Percentage of school children's discomfort for the different IEQ aspects in their classrooms. 72
- 3.2 Percentage of teachers who performed these actions at least once a day in the classrooms. 73
- 3.3 Percentage of teachers, for different types of schools, who were asked by the children to perform these adjustments at least once a day. 76
- 3.4 Relationships between children's comfort perceptions, requests and teachers' actions. 77
- 3.5 Relationships between children's comfort perceptions, requests and teachers' actions at different schools. 81
- 4.1 Importance index of indoor environmental factors in all (A), traditional (T), and non-traditional (N) classrooms. 108
- 4.2 Preference of the ICDs indicated by the school children. 108
- 5.1 The layout in the chambers. 137
- 5.2 Mean values of children's test scores in different experimental conditions for chamber A and B. 145
- 5.3 Mean values of children's influence assessment in different experimental conditions for chamber A and B. 147
- 5.4 Excerpt from acoustical chamber questionnaire for the listening task. 149
- 5.5 The set-up in one of the chambers. 161
- 5.6 Excerpt from acoustical chamber questionnaire for the listening task. 163
- 5.7 The distribution of children's test scores. 165
- 5.8 The distribution of children's sound perceptions. 166
- 5.9 The distribution of children's influence assessment. 167
- 5.10 Difference of children's test scores between Chamber A and B. 169
- 5.11 Difference of children's sound perceptions between Chamber A and B. 170
- 5.12 Difference of children's influence assessment between Chamber A and B. 170
- 6.1 Experience room in the SenseLab [25]. 179
- 6.2 Schematic diagrams of the settings. 182
- 6.3 Distribution of sources (A0-A4) and receivers (01-04). 183
- 6.4 A model to describe the Lombard effect [29]. 185
- 6.5 Setting of the classroom in the SenseLab. 188
- 6.6 Figure 6.6 Settings in the verified simulation. 188

- 6.7 Acoustic simulation results in different positions in the instruction situation. 193
- 6.8 Acoustic simulation results in different positions in the self-study situation. 195
- 6.9 Acoustic simulation results in different positions in the conversation situation. 198
- 7.1 The layout in the test chamber. 211
- 7.2 The schematic diagram of the ICND. 213
- 7.3 Examples of icons added to the questionnaire to increase understandability. 213
- 7.4 The setting inside (left) and outside the test chamber [27] during the measurement. 215
- 7.5 The layout of the simulated room and the positions of the source (A0) and receiver (O1). 217
- 7.6 The classification of subcategories based on the “like/dislike” question. 222
- 7.7 The classification of subcategories based on the “wanted/unwanted” question. 223
- 7.8 The classification of subcategories based on the “improvement suggestions”. 224
- 8.1 The main stages and the main aims of this PhD study. 235
- 8.2 Percentage of teachers who performed these actions at least once a day in the classrooms. 238
- 8.3 The cartoon figure added in the children's questionnaire (with permission from Robert Laszlo Kiss). 239
- 8.4 The prototype of the individually controlled noise-reducing device. 242

List of Abbreviations

(in order of appearance)

CSC	China Scholarship Council
IEQ	Indoor environmental quality
IAQ	Indoor air quality
CATT	Computer Aided Theatre Technique
ICND	Individually controlled noise-reducing device
ASHRAE	American Society of Heating, Refrigerating and Air-conditioning Engineers
WHO	World Health Organization
VOCs	Volatile organic compounds
CO ₂	Carbon dioxide
RT	Reverberation time
HAVC	Heating ventilation and air conditioning
PSC	Personal comfort systems
PEC	Personal environmental control system
PM	Particulate matter
IMCDS	Individual microclimate control devices
PV	Personal ventilation
US EPA	United States Environmental Protection Agency
ICDs	Individually controlled devices
PCA	Principle components analysis
SPL	Sound pressure level
ADHD	Attention Deficit Hyperactivity Disorder
HA	High arousal potential
LA	Low arousal potential
ANOVA	Analysis of variance
STI	Speech transmission index
ICND	Individually controlled noise-reducing devices

Summary

In recent decades, many indoor environmental quality (IEQ) related problems (such as noise, odour, overheating, glare...) in classrooms have been identified. The impact of IEQ in classrooms on school children has been thoroughly researched. Consequently, many studies have been carried out to attempt to improve the IEQ in classrooms. However, most of the IEQ-improvements were developed based on general requirements and ignored individual differences. No matter how advanced these improvements are, always some children keep being unsatisfied with the IEQ in their classrooms. Given the fact that different children have different IEQ perceptions, preferences, and needs, it makes more sense to control the IEQ in classrooms on the level of the individual rather than of the room. Only by doing this can the comfort, health, and ultimately performance of school children be improved. For this reason, this research explored the possibility of customizing IEQ in classrooms of primary schools in the Netherlands. This thesis addressed the following topics:

- Current ways of controlling IEQ in classrooms and their effect on school children's IEQ perception;
- Individual preferences and needs of primary school children related to IEQ in classrooms;
- Impact of the main IEQ problem on school children's perception and performance;
- Use of individually controlled devices to cope with the main IEQ problem in classrooms;
- Children's feedback on an individually controlled noise-reducing device.

Several approaches were used to address these topics, including a field study, lab studies, computer simulations and a prototype study.

In the spring of 2017, the indoor environment group conducted the field study in 54 classrooms of 21 primary schools in the Netherlands. 54 teachers' questionnaire and 1145 children's questionnaire were collected and analysed. The results of the field study provided insight into the current ways to control IEQ in classrooms, as well as the preferences and needs of children with respect to IEQ in their classrooms.

Through a series of correlation analyses, the current ways to control IEQ, namely teachers' IEQ-improving actions, were shown to be inefficient in improving children's IEQ perceptions in classrooms, even though these actions were conducted based on children's requests. Two possible explanations can be put forward. First, a teacher could only take one action to respond to one child at a time, therefore, another child's request might have been ignored. Second, the options that teachers had to change the IEQ in classrooms were quite limited (for example, in most classrooms, opening windows was the only thing the teacher could do if children felt too hot in summer). It was, therefore, concluded that a more effective method to control the IEQ in classrooms is needed.

To create a good learning environment for school children, it is important to know their perceptions, preferences, and needs concerning IEQ in their classrooms. The analyses of the 1145 children's responses showed that different children within the same classroom could have different IEQ perceptions, preferences, and needs. Based on their IEQ perceptions, preferences, and needs and with the use of a two-step cluster analysis method, the children were grouped into six clusters ('Sound concerned', 'Smell and Sound concerned', 'Thermal and Draught concerned', 'Light concerned', 'All concerned' and 'Nothing concerned'), with each a different profile was established.

The analysis of the children's responses also showed that 87% of the children were bothered by noise (mainly caused by themselves) in their classrooms. Therefore, noise was identified as the main problem in the classrooms studied. To get more insight in this main problem, a lab study was conducted in the spring of 2018 in which children were invited to participate in a listening task with different background sounds. The experiment was conducted in two chambers (acoustically treated chamber and untreated chamber) with different reverberation times (RTs) at the same time. Results of the two-way ANOVA analysis showed a significant interaction between the impact of sound type and sound pressure level (SPL) on children's performance in the untreated chamber ($RT = 0.3$ s). Additionally, the t-test results showed that children performed significantly better in the untreated chamber than in the treated chamber ($RT = 0.07$ s). This indicated that a shorter RT is not always better, and it was recommended to also introduce a lower limit for the RT in classrooms to prevent over-damping.

After the establishment of the main IEQ problem, namely noise, the next step of this research was searching for an effective way to address this problem. Because the use of individually controlled devices in offices has shown to be able to improve both the IEQ and the workers' satisfaction rates, it was assumed that these devices can have a similar effect on children in classrooms. To get a preliminary understanding

of this assumption, a series of computer simulations was therefore conducted to test the effect of an individually controlled device on noise reduction. By comparing the simulation results of these individually controlled devices with the conventional ways to reduce noise (namely acoustic ceiling tiles), it was seen that the individually controlled devices have the ability to provide better acoustics in terms of providing shorter RTs and higher speech transmission indices.

Subsequently, a real individually controlled noise-reducing device (ICND) was prototyped and tested in a lab study during the summer and autumn vacation of 2019. This prototype was similar to the simulated device. It looks like a large umbrella that hung above every child's head. In this research, two identical prototypes were tested with more than 200 school children, whose feedback was collected through questionnaires. Children could control the device using a remote controller. The descriptive analysis of children's answers indicated that most of them liked this device and wanted to have one in their classrooms. The content analysis elucidated the reasons for their choices: children liked this device mainly because of its appearance (they thought it looked funny/cool/nice), and they wanted to have it mainly because of its functionality (they thought it worked/helped/reduced noise). Additionally, the device's noise reducing effect was confirmed by simulations and measurements. This study showed the potential of the ICND to create better acoustics for every school child, and resulted in clear recommendations to improve the prototype.

To sum up, this research showed that school children differ in their IEQ preferences and needs and, based on that, classified them into six clusters. It also indicated that teachers' actions could not effectively improve IEQ in classrooms, which paves the way for the need for individual control of IEQ in classrooms of primary schools. Then, an ICND was designed and tested to address the main IEQ problem in classrooms, namely noise. The results obtained from the simulations, measurements, and children's feedback on the prototype of the ICND, indicated the feasibility of such devices in classrooms at primary schools. More research in real classrooms, however, is needed.

Samenvatting

In de laatste decennia zijn veel problemen gerelateerd aan de binnenmilieukwaliteit (zoals lawaai, geur, oververhitting, verblinding...) van klaslokalen geïdentificeerd. Het effect van binnenmilieukwaliteit in klaslokalen op schoolkinderen is grondig onderzocht, met als gevolg veel studies waarin pogingen zijn ondernomen om de binnenmilieukwaliteit van klaslokalen te verbeteren. Echter, de meeste van de resulterende verbeteringen van de binnenmilieukwaliteit zijn ontwikkeld op basis van algemene eisen, individuele verschillen zijn niet meegenomen. Het maakt niet uit hoe vooruitstrevend deze verbeteringen zijn, er zullen altijd een aantal kinderen ontevreden met de binnenmilieukwaliteit van hun klaslokalen zijn. Gegeven het feit dat verschillende kinderen, verschillende percepties, voorkeuren en eisen t.a.v. de kwaliteit van het binnenmilieu hebben, lijkt het logischer om de binnenmilieukwaliteit van klaslokalen op individueel niveau te regelen in plaats van op lokaalniveau. Alleen door dat te doen kan het comfort, de gezondheid, en uiteindelijk de prestatie van schoolkinderen verbeterd worden. Vanwege deze reden heeft dit onderzoek de mogelijkheid van op het individu afgestemde binnenmilieukwaliteit van klaslokalen op basisscholen in Nederland onderzocht. Deze dissertatie adresseert de volgende onderwerpen:

- Huidige manieren van het regelen van binnenmilieukwaliteit van klaslokalen en hun effect op de perceptie van de kwaliteit van het binnenmilieu door schoolkinderen;
- Individuele voorkeuren en eisen van basisschoolkinderen gerelateerd aan binnenmilieukwaliteit van klaslokalen;
- Het effect van het voornaamste binnenmilieukwaliteitsprobleem op de perceptie en prestatie van schoolkinderen;
- Het gebruik van individueel regelbare devices om te kunnen omgaan met het voornaamste binnenmilieukwaliteitsprobleem van klaslokalen;
- Feedback van kinderen op een individueel regelbaar geluid reducerend device.

Verschiede manieren van onderzoek zijn toegepast om deze onderwerpen te adresseren, waaronder een veldstudie, lab studies, computersimulaties en een prototype studie.

In het voorjaar van 2017, heeft de Binnenmilieu groep een veldstudie in 54 klaslokalen van 21 basisscholen in Nederland uitgevoerd. 54 leraren vulden een vragenlijst voor leraren in, en 1145 kinderen een vragenlijst voor kinderen, waarvan de gegevens vervolgens zijn verzameld en geanalyseerd. De resultaten

van de veldstudie gaven inzicht in de huidige manieren van het regelen van de binnenmilieukwaliteit van klaslokalen, evenals de voorkeuren en eisen van kinderen t.a.v. de binnenmilieukwaliteit van hun klaslokalen.

Middels een serie van correlatieanalyses werd aangetoond dat de huidige manieren om de binnenmilieukwaliteit te regelen, namelijk door de acties van leraren, niet de perceptie van de binnenmilieukwaliteit door de kinderen verbeterden, zelfs wanneer deze acties op het verzoek van de kinderen werden uitgevoerd. Twee mogelijke verklaringen kunnen naar voor worden gebracht. Ten eerste, een leraar kon slechts één actie per keer uitvoeren als reactie op één kind, waardoor een ander verzoek van een ander kind waarschijnlijk werd genegeerd. Ten tweede, de mogelijkheden die leraren hebben om de binnenmilieukwaliteit in klaslokalen aan te passen, zijn gelimiteerd (bijvoorbeeld, in de meeste klaslokalen kon de leraar alleen maar een raam openen wanneer kinderen het te warm hadden in de zomer). Er werd daarom geconcludeerd dat een effectievere methode voor het regelen van de binnenmilieukwaliteit in klaslokalen nodig is.

Voor het creëren van een goede leeromgeving voor schoolkinderen is het belangrijk om hun percepties, voorkeuren, en eisen van de binnenmilieukwaliteit van hun klaslokalen te weten. De analyses van de antwoorden van 1145 kinderen lieten zien dat verschillende kinderen in hetzelfde klaslokaal verschillende percepties, voorkeuren en eisen van de binnenmilieukwaliteit kunnen hebben. Op basis van hun percepties, voorkeuren en eisen van de binnenmilieukwaliteit en met gebruik van een twee-stap clusteranalyse methode werden de kinderen in zes clusters verdeeld ('Geluid bezorgd', 'Geur en Geluid bezorgd', 'Temperatuur en Tocht bezorgd', 'Licht bezorgd', 'Alles bezorgd' en 'Niets bezorgd'), met elk een verschillen profiel.

De analyse van de antwoorden van kinderen gaven ook aan dat 87% van de kinderen last hadden van lawaai (vooral door henzelf veroorzaakt). Daarom werd geconstateerd dat lawaai het voornaamste probleem in de onderzochte klaslokalen was. Om meer inzicht in dit voornaamste probleem te krijgen werd in het voorjaar van 2018 een lab studie uitgevoerd, waarin kinderen aan een luistertest met verschillende achtergrondgeluiden deelnamen. Het experiment werd simultaan in twee ruimten met verschillende nagalmtijden (T) uitgevoerd, zodat het effect van de nagalmtijd in deze twee ruimten door het vergelijken van de resultaten middels t-testen ook kon worden bepaald. Tweeweg ANOVA-analyse resulteerde in een significant interactie tussen het effect van het geluidstype en het geluidsdrukniveau (SPL) op de prestatie van de kinderen in de onbehandelde ruimte ($T = 0.3$ s). De uitkomsten van de t-test lieten zien dat kinderen significant beter presteerden in de onbehandelde ruimte dan in de behandelde ruimte ($T = 0.07$ s). Dit gaf aan dat een kortere nagalmtijd niet altijd beter is, en aanbevolen werd om ook een ondergrens voor de nagalmtijd in klaslokalen te introduceren ter voorkoming van over-damping.

Na het bepalen van het voornaamste binnenmilieukwaliteitsprobleem, lawaai, bestond de volgende stap in dit onderzoek uit het zoeken naar een effectieve manier om dit probleem te adresseren. Omdat het gebruik van individueel regelbare devices in kantoren heeft laten zien dat die zowel de binnenmilieukwaliteit als de tevredenheid van de medewerkers kan verbeteren, werd aangenomen dat deze devices een soortgelijk effect op kinderen in klaslokalen zouden kunnen hebben. Als vooronderzoek van deze aanname werd een serie van computersimulaties uitgevoerd om het effect van een individueel regelbaar device voor het reduceren van lawaai te testen. Door de simulatieresultaten van deze individueel regelbare devices te vergelijken met conventionele manieren om geluid te reduceren (akoestische plafondplaten), werd aangetoond dat deze individueel regelbare devices de mogelijkheid hebben om een betere akoestiek te leveren in termen van kortere nagalmtijden en betere spraakverstaanbaarheid.

Daarna werd een prototype van een echt individueel regelbaar lawaai-reducerend device (IRLD) gemaakt en getest in een lab studie tijdens de zomer- en herfstvakantie van 2019. Dit prototype was gelijk aan het device van de simulaties. Het lijkt op een paraplu die boven elk kinds hoofd hangt. In dit onderzoek werden twee identieke prototypes getest met meer dan 200 schoolkinderen, wier feedback werd verzameld middels vragenlijsten. Een afstandsbediening was aanwezig voor het openen of sluiten van het device. De analyse van de antwoorden van de kinderen liet zien dat de meesten van hen dit device leuk vonden en er graag één wilden hebben in hun klaslokaal. Daarnaast gaf de analyse de redenen aan voor hun keuzes: kinderen vonden het device vooral leuk vanwege het uiterlijk (ze vonden dat het er grappig/koel/leuk uitzag), en ze wilden het hebben vooral vanwege de functionaliteit (ze vonden dat het werkt/helpt tegen lawaai). Daarnaast werd het geluid reducerend effect van het device bevestigd door simulaties en metingen. De studie liet de potentie van het IRLD zien om betere akoestiek voor elk schoolkind te creëren, en resulteerde in duidelijke aanbevelingen voor het verbeteren van het prototype.

Samenvattend, dit onderzoek heeft met de zes geïdentificeerde profielen laten zien dat schoolkinderen verschillen in hun voorkeuren en eisen van binnenmilieukwaliteit. Daarnaast werd aangetoond dat met de acties van leraren de binnenmilieukwaliteit in klaslokalen niet genoeg verbeterd, hetgeen de behoefte aangeeft van individuele regeling van binnenmilieukwaliteit van klaslokalen in basisscholen. Een prototype van een IRLD werd ontworpen, gemaakt en getest om het voornaamste probleem in het binnenmilieu aan te pakken, namelijk lawaai. De resultaten verkregen middels simulaties, metingen en feedback van kinderen over het prototype gaven inzicht in de haalbaarheid van dergelijke devices in klaslokalen in basisscholen. Meer onderzoek in klaslokalen in de praktijk is echter nodig.

总结

近几十年来，许多与教室环境质量（IEQ）有关的问题（例如噪音、异味、过热、眩光……）引起了一众学者的关注，教室环境质量对学生的影响也得到了深入研究和了解。为了改善教室内的环境质量，很多课题正在逐渐开展。但是，大多数改善室内环境的方法都是为了满足整体性或一般性的要求，从而忽略了个体差异。因此，无论这些改善办法多么先进，仍旧会有一些学生对教室里的环境质量感到不满意。鉴于不同的学生对室内环境有着不同的感知、不同的喜好，和不同的需求，在教室里进行个性化单独控制要比整体控制更有效果。只有这样做，才能全面改善学生的舒适水平和健康状况，并最终提高他们的学习表现。因此，本课题旨在探索在荷兰小学教室内单独控制室内环境的可行性，具体可分为以下几个主题：

- 当前小学教室环境质量的控制办法及其对小学生的影响；
- 小学生对教室内环境的不同偏好和需求；
- 主要的室内环境问题对小学生的环境感知和学习表现的影响；
- 使用可单独控制的设备来解决教室中最主要的环境问题；
- 小学生对可单独控制的降噪设备的体验反馈。

为了研究这些主题，本课题利用了以下几种研究方法：现场调研、实验分析、计算机模拟、和设备研发。

2017年春季，本人同所在的室内环境课题组成员在21所荷兰小学的54个教室中进行了一些列的现场调研。此调研共收集了54份教师问卷和1145份学生问卷。通过对这些问卷进行分析，本课题初步了解了当前小学教室内环境的控制办法以及小学生对教室环境的不同偏好和需求。

通过一系列相关性分析，本课题发现当前教室环境的控制办法，即教师所采取的改善室内环境的行为，是不足以满足小学生的需求的。尽管教师可以依据小学生的要求而采取相应的行动，但这些行为并不能有效提高小学生在教室内的舒适感。对于此结果，本课题提出了两种可能的解释。首先，一名教师一次只能针对一名小学生的要求采取一项行动，因此，其他小学生的要求可能会被忽略。其次，教师在教室中用以提高室内环境的行为非常有限（例如，如果小学生在夏天感觉太热，在大多数小学教室中，开窗是老师唯一可以采取的行动）。因此本课题认为当前小学教室内需要一种更有效的控制教室内环境的办法。

为了给小学生创造一个舒适的学习环境，首先要了解他们对教室内环境质量的感知、偏好和需求。本课题通过对1145名小学生的问卷进行分析，发现不同小学生对同一教室环境有着不同的生理感知、偏好和需求。根据他们对室内环境的感知、偏好和需求，本课

题利用两步聚类法，将小学生们分成了六个类型（“在意声音”、“在意气味和声音”、“在意温度和吹风感”、“在意光”、“在意所有环境元素”和“什么都不在意”），并对每类小学生的特点都进行了分析和介绍。

通过对小学生的问卷进行分析，本课题还发现有高达87%的荷兰小学生受到教室内噪音的困扰（其来源主要是小学生们自己）。因此，噪声被确定为所调研教室内的主要环境问题。为了对该问题有一个更全面的认识，本课题组在2018年春季开展了一项实验室研究，并邀请小学生参与了一系列在不同背景声音下的听力测试。该测试是在两个具有不同混响时间（RT）的小室（经过声学处理的小室和没有经过处理的小室）中同时进行的。本课题利用双因素方差分析确定了在未经处理的小室（ $RT = 0.3\text{ s}$ ）内，声音类型和声压级（SPL）对小学生表现存在显著的交互影响。另外，通过利用t检验比较这两个小室内的实验结果，本课题表明，小学生在未经处理的房间中的表现明显好于在经过处理的房间中（ $RT = 0.07\text{ s}$ ）的表现。这说明混响时间并不一定是越短越好。因此，本课题建议在教室声环境标准中也应该设定混响时间下限，以防止过度吸音。

在明确了最主要的教室环境问题（即噪音）之后，本课题的下一步研究内容即为寻找解决该问题的有效方法。一些研究已经证明在办公室中使用可独立控制的设备可以提高环境质量和员工的满意度，因此本课题猜测可独立控制的设备对教室中的小学生也有类似的影响。为了对该假设进行初步验证，本课题开展了一系列计算机模拟，以测试可独立控制的降噪设备的对教室内声环境的改善效果。通过将其使用效果与传统降噪方法（即隔音天花板）的使用效果进行比较，本课题得出结论：可独立控制的降噪设备可以创造出更好的声学环境，即可以缩短混响时间并提高的语音传输指数。

随后，在2019年的夏季和秋季，本课题设计并制造了一个真实的可独立控制的降噪设备（ICND），并在实验室内对其使用效果进行了测试。该设备与模拟的设备相似。其外观为伞状，可以悬挂在每个小学生的桌椅上空。在该测试中，共有200多名小学生对两个相同的设备进行了体验并填写了相关的调查问卷，测试时，他们可以使用遥控器打开或关闭设备。通过对小学生的反馈进行分析，本课题发现他们中的大多数人喜欢该设备，并希望在教室里拥有一台这样的设备。之后，本课题利用内容分析深入发掘了这背后的原因：小学生之所以喜欢此设备，主要是因为它的外观（他们认为它看起来很有趣/很酷/很漂亮），他们希望拥有它的原因主要是因为它的功能（他们认为它可以工作/有帮助/降低噪音）。此外，本课题利用计算机模拟和测量进一步验证了该设备的降噪效果。综合所有研究结果，本课题表明这台可独立控制的降噪设备可以为每个小学生创造更好的声音环境，并根据小学生发反馈对该设备提出了改进建议。

综上，本课题根据小学生对所在教室环境的不同感知，偏好和需求对其进行分类，发现了六种不同类型的小学生，并指出教师的改善室内环境的行为并不能有效提高小学生对教室环境的感知，这些结果引发了在小学校教室内进行独立控制的研究。因此，本课题设计并制作了一个旨在解决教室内最主要的环境问题（即噪音）的可独立控制的降噪设备。综合该设备的模拟、测量、和小学生对其的体验反馈结果，本课题确定了该设备的可行性。但是，此设备仍需要在实际教室中进行进一步研究。

1 Introduction

Primary school children spend 779 hours on average in school per year, and this number is much higher in developing countries [1, 2]. In this context, the indoor environmental quality (IEQ) in primary school classrooms could significantly affect children's development. Indoor environmental quality, as the name suggests, concerns the environmental conditions inside the building, including indoor air quality (IAQ), acoustical quality, visual quality and thermal quality [3]. Each of these factors has been proved to play a vital role on children's health, comfort and learning performance.

1.1 Problem statement

The poor IEQ in classrooms of primary schools, due to for instance overheating or undercooling, glare, bad IAQ, and noise, is not a new problem; it has been documented by many researchers around the world. IEQ problems were already reported in the 1990s. For example, Kuller and Lindsten [4] conducted a study in Sweden in 1992 to determine the impact of daylight on children's behaviour. They indicated that children in classrooms without windows might have problems in their hormone pattern, which might undermine their ability to concentrate and cooperate; a lack of illuminance might also have impact on children's annual growth. In regard to the impact of IAQ, Shendell et al. [5] found that at least 50% of schools in Washington and Idaho, USA, could not meet the ventilation standard, and an increase in the elevation of the indoor CO₂ concentration above the outdoor concentration was associated with a decrease in yearly attendance. In addition, studies conducted in countries in the tropics, such as Singapore, claimed that school children there generally accepted cool thermal sensations more readily and nearly half of them complained about the radiant heat from windows [6]. Moreover, a recent investigation of Bluysen et al. [7] showed that noise is the biggest problem in classrooms of primary schools in the Netherlands. More than 80% of children reported to be bothered by noise, and according to these children, most of the noise came from their classmates.

There is no doubt that a feeling of discomfort has a negative impact on children's wellbeing and performance, whether this discomfort is caused by lighting, noise, temperature, or air quality. Therefore, many studies have been devoted to the improvement of the IEQ in primary school classrooms. Traditionally, these solutions were provided on the classroom level, which does not regard children's individual differences. And it is always the teacher who has the authority to control the environment, so it is hard for children to change this environment even if they feel uncomfortable. Moreover, the typical definition of a 'good indoor environment' is where 80% of the occupants are satisfied [8], which means that the remaining 20% have to endure an environment that may adversely affect their comfort and performance. As a result, none of these solutions could achieve 100% satisfaction, there is always someone who feels uncomfortable.

Fortunately, there is a way to make everyone feel satisfied concerning the IEQ, which is 'individual control': each occupant can adjust their own local environment. According to Fanger, individual control was one of the main principles to achieve the excellent air-conditioned environments of the future [9]. Wyon also claimed that individual control should make it possible to produce 100% satisfaction [10]. In the recent decades, many individually controlled devices, such as heated chairs or personal ventilation, have been developed and tested. Many studies have demonstrated the significant effect of individual control on improving occupants' satisfaction and IEQ [11-13]. However, almost none of these studies applied individual control to classrooms, and hardly any of these individually controlled devices were designed based on children's requirements.

1.2 Scientific context

Individual control is recognized as an effective method not only to improve the IEQ but also to increase occupants' satisfaction, even up to 100%. A number of researchers have reported on the function of different individually controlled devices in terms of different IEQ factors [14-20], and these devices can be generalized as follows:

- **Local air vents.** This kind of devices include nozzles and diffusers in workplaces and desks. Air flows usually come from the front or from the side. Some of these vents can be rotated, and the air temperature and speed are variable.

- **Chairs, heated or cooled; or ventilated.** Most heated chairs use an electric resistance heating element, warm water tubes or encapsulated carbon fabric in their back or bottom surface, while cooled chairs use isothermal air convection, cooled water tubes, or fans in the back or bottom of the chairs. These chairs have already been used in some offices.
- **Radiant heating panels.** This kind of devices can be installed on the desk to warm arms, under the desk to warm legs or on the floor to warm feet. Given the fact that spatial alliesthesia, or local discomfort plays a vital role in influencing people's thermal sensation [21], so, applying these local heating devices to the thermal sensitive extremities could improve occupants' thermal satisfaction effectively.
- **Task-ambient light.** This refers to a lighting system with general lighting and local task luminaires. It can provide the exact amount of lighting required to perform some tasks, and it could save energy since the light level for the whole environment can be lower.

Although some of these devices have not been fully developed or widely adopted in our daily life, all of these devices have showed a positive impact on occupants' comfort and satisfaction. However, almost all of these devices were designed for adults, and they were tested only in offices or office-like environments; hardly any of them can be used by primary school children in classrooms. In addition, regarding the impact on IEQ, these devices have covered almost all aspects of IEQ, except acoustics. Until now, the most common way to improve indoor acoustics is adding sound-absorption materials on ceilings or walls. The only acoustic individually controlled device developed so far is a headphone. However, wearing headphones can hardly be an option when communication is needed. Therefore, how to achieve individual control in acoustics and how to apply these methods to primary schools still need to be understood.

1.3 Research aims and questions

A recent field study in the Netherlands found that most of the school children were not satisfied with the IEQ in their classrooms [7]. Considering the need for a more effective way to improve both the IEQ in primary school classrooms and children's satisfaction, along with the positive potential of individual control, this thesis aims to

propose a new way - individual control - to improve the IEQ in classrooms of primary schools and to increase children's satisfaction in the Netherlands. Given the limited time, this research only focuses on the most serious IEQ problem in Dutch primary school classrooms. Correspondingly, the following main research question is posed:

How to solve the main indoor environmental problem in classrooms of primary schools?

In order to address the main question of this thesis, the following key questions are also posed:

- 1 What are the IEQ-related problems and solutions in classrooms of primary schools?**
- 2 What are the underlying reasons for these problems? Which can be rephrased as the following two questions:**
 - 2 A** How do available ways to control the indoor environment work?
 - 2 B** What are the preferences and needs for IEQ of different school children?
- 3 What is the effect of the main IEQ problem - noise - on children's sound perception and school performance?**
- 4 How can we solve the main IEQ problem by means of individual control in primary school classrooms?**
- 5 How well does an individually controlled acoustic device work from an acoustic and a user perspective?**

These six key questions correspond to chapters 2-7 respectively, and each of them corresponds to a sub-aim as well (See Figure 1.1).

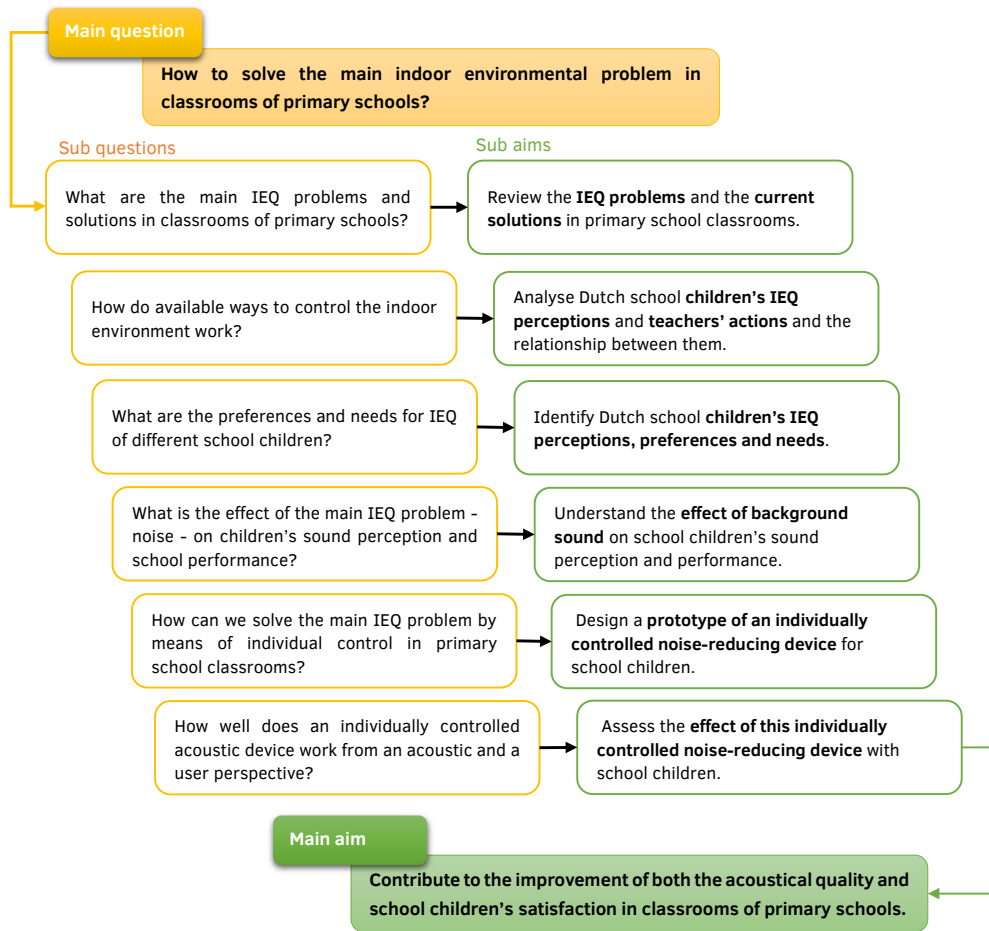

FIG. 1.1 Research questions and aims of this study.

1.4 Research methods

To answer the research questions, a literature study, a field study, a lab study and a prototype study was performed, each question corresponding to one study (See Figure 1.2). As shown in the Figure 1.2, each of these studies comprised more than one research topic. The field and lab studies were part of the research programme conducted in and by the indoor environment group at the Faculty of Architecture and the Built Environment of the TU Delft. Therefore, they were designed, conducted and analysed together and comprised of more than the results reported in this PhD thesis (see the coloured boxes in Figure 1.2).

Literature review, as a basic research method, is widely used in various fields. Usually, it is the first step of a study and provides the background information for further research. The same goes for this research, to be specific, the literature study introduced in this thesis included two parts, one was focused on the current state of the IEQ in classrooms, and the other one concerned research into individual control of IEQ.

To identify IEQ-related problems in Dutch primary school classrooms, a field study was conducted, which involved questionnaires, classroom inspections, and measurements in 21 primary schools in the Netherlands [7]. In total, 54 primary school teachers and 1145 school children participated. According to the teachers' answers, this study demonstrated the limitations of teachers' IEQ-improving actions in classrooms. While according to the children's answers, noise from classmates was identified as the most serious IEQ-problem [7]; it was also found that different children were bothered by different problems and have different preferences in terms of the IEQ in their classrooms. Based on their IEQ perceptions and needs, all the participating children were clustered (by means of the two-step cluster analysis in SPSS) into six groups.

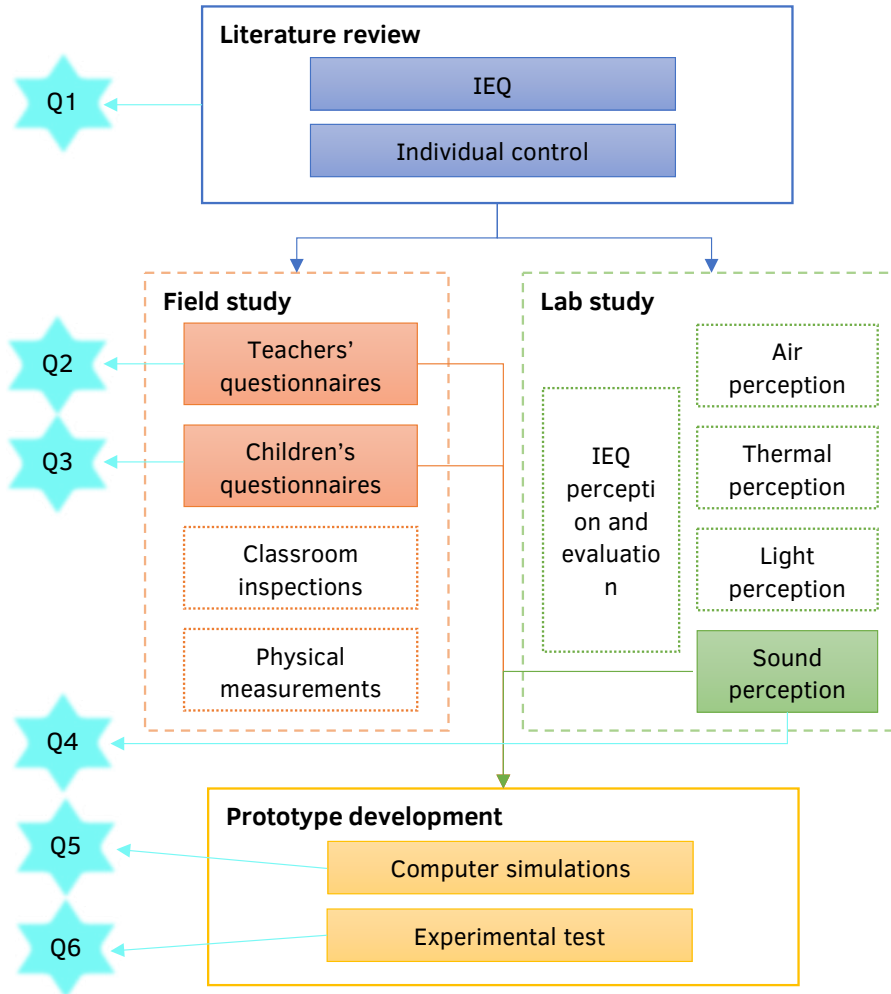

FIG. 1.2 Methodology scheme of this study.

Note: only the topics in the coloured boxes were involved in this thesis.

Next, a series of lab studies was carried out in the SenseLab [22] to evaluate the impact of the IEQ on school children. Since noise was found to be the most serious problem in the field study, this thesis only focuses on the acoustic experiment that was aimed to test the impact of background sound on school children's sound perception, comfort and school performance.

Finally, a new way – individual control – was provided to improve the IEQ in classrooms and it was tested by computer simulations using the Computer Aided Theatre Technique (CATT-Acoustic™) room acoustics software. These computer simulations were able to estimate the expected acoustic effect of this new individually controlled device before construction; the results demonstrated the effectiveness of this new device by comparing it to acoustic ceiling tiles. After that, another experiment was conducted in the SenseLab to test a prototype of the device with children and collect their feedback.

A more detailed description of each research method used is included in the respective chapters.

1.5 Thesis outline

The outline of this thesis is presented in Figure 1.3. On the whole, Chapters 2-5 are mainly about the research gaps and current problems identified by the present research, while Chapters 6-7 are focused on the solution. Additionally, chapters 2-7 correspond, respectively, to the six key research questions.

Chapter 2 is a literature review about the studies related to the IEQ in classrooms and to individual control. It first provides an overview of the current state of IEQ in classrooms and the effect of IEQ on school children's health, comfort and performance. Then it presents the current methods to improve IEQ in classrooms. At last, it introduces the concept of individual control and presents the state-of-the-art on individually controlled devices and their effectiveness.

Chapter 3 describes the current ways to improve or change the IEQ in classrooms through the actions of teachers. It discusses how well these actions work with respect to children's reactions. It reveals that teachers cannot fulfil every child's needs in a classroom, even though teachers did related to children's requests.

Chapter 4 discusses children's different preferences and needs related to IEQ in classrooms. Based on that, children who participated in this study are clustered into different groups, which paves the way to effectively improve both the IEQ and children's satisfaction.

Chapter 5 is focused on the acoustics of a classroom and its impact on children, because in the previous chapters, noise (from classmates) showed to be the main problem in classrooms. Not only the interaction effect of the background sound type and sound pressure level, but also the impact of acoustic treatment are studied experimentally.

Chapter 6 provides a new way, an individually controlled device, to improve the acoustics in classrooms. To demonstrate how well it works, several computer simulations are run, and the results of the comparison between this device and an acoustic ceiling shows the advantage of individual control.

Chapter 7 is the sequel of Chapter 6; it shows children's responses to the new individually controlled acoustic device, and it discusses the possible improvements to the device based on children's feedback.

Chapters 8, finally, presents a general discussion and the conclusions of the whole research. Some recommendations for future studies are given and limitations of this study are discussed.

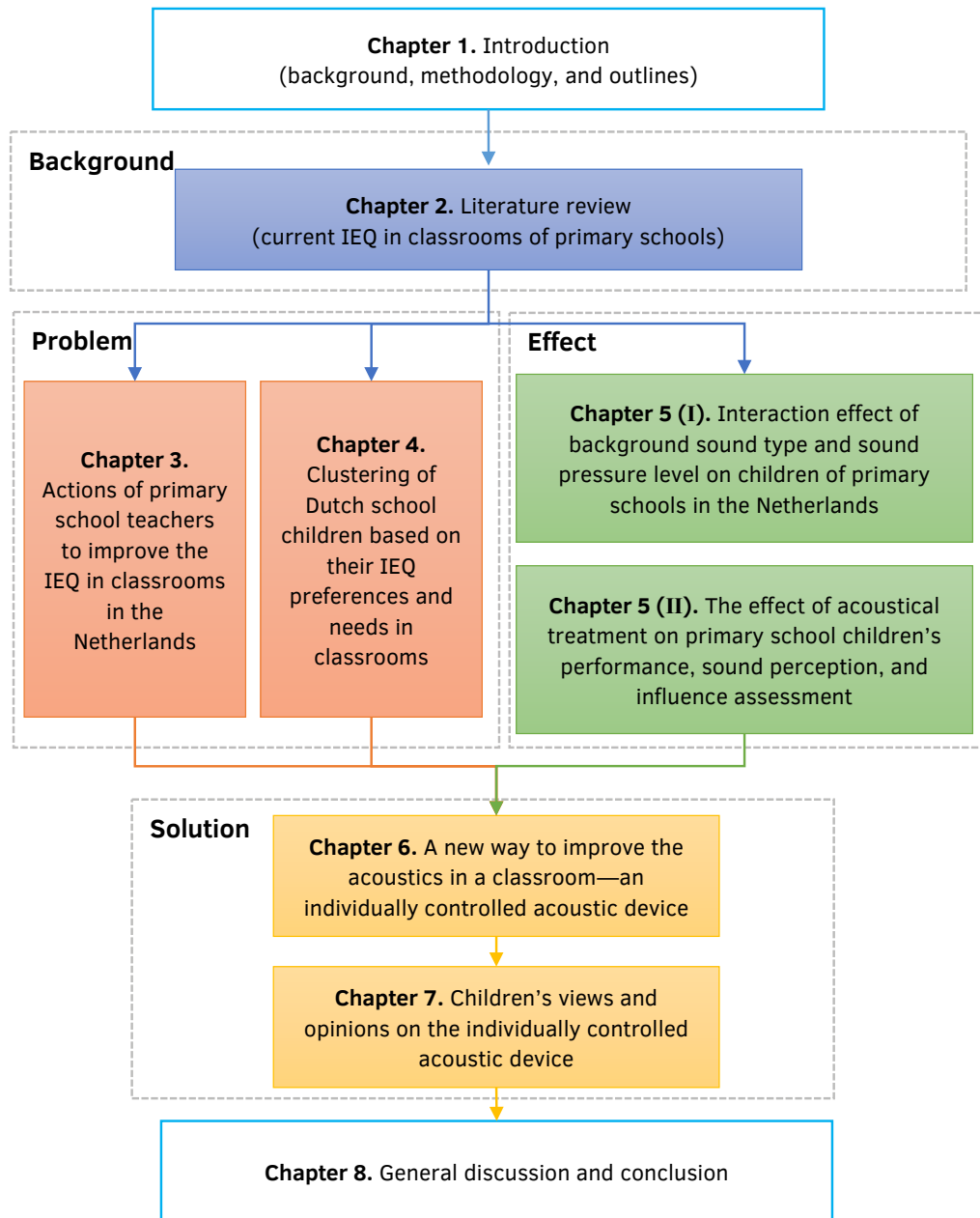

FIG. 1.3 Outline of this thesis.

Note: the different background colours of chapters 2-7 represent different research methods: blue represents literature review; orange represents field study; green represents lab study; yellow represents prototype development.

1.6 Research contribution

This research is devoted to achieving customization of the IEQ in primary school classrooms, and thus improve children's satisfaction and learning performance. It has made three main contributions to the field of IEQ, especially in classrooms.

Firstly, this research introduced the idea of "individual control" into the studies of the IEQ in classrooms. Although the topic of individual control is not new, it has never been applied to primary school classrooms. Moreover, almost all the individually controlled devices have been designed based on adult's requirements, and experiences; hardly any of them has been designed for children.

Secondly, this research took a new perspective, which is children's view, to investigate the IEQ problems in classrooms and put forward solutions. There have been many previous studies into the IEQ also involving children's questionnaires or interviews. Most of them, however, only focused on their perceptions, while children's requirements and preferences were not given enough attention. Only from a children's viewpoint, the most practical solution can be found. Therefore, this study first investigate children's IEQ requirements and needs by asking them to rank ten IEQ factors in order of importance and to choose their favourite individually controlled devices.

Last but not least, a pioneering individually controlled noise-reducing device (ICND) has been designed during this research, and simulation results have demonstrated its positive impact on acoustics in classrooms. Furthermore, according to the analysis of children's feedback, they showed strong interests and expectations to the ICND although it was just a prototype in an experimental phase.

References

- [1] Parinduri, R.A., Do children spend too much time in schools? Evidence from a longer school year in Indonesia. *Economics of Education Review*, 2014. 41: p. 89-104.
- [2] Burgess, M. MAPPED: How many hours do children spend at school around the world? 2013 [cited 2019 Sep 27, 2019]; Available from: <http://helpmeinvestigate.com/education/2013/04/mapped-how-many-hours-do-children-spend-at-school-around-the-world/>.
- [3] Bluyssen, P.M., *The Indoor Environment Handbook: How to make buildings healthy and comfortable*. 2009: Routledge.
- [4] Küller, R. and C. Lindsten, Health and behavior of children in classrooms with and without windows. *Journal of Environmental Psychology*, 1992. 12(4): p. 305-317.
- [5] Shendell, D.G., R. Prill, W.J. Fisk, M.G. Apte, D. Blake, and D. Faulkner, Associations between classroom CO2 concentrations and student attendance in Washington and Idaho. *Indoor air*, 2004. 14(5): p. 333-341.
- [6] Wong, N.H. and S.S. Khoo, Thermal comfort in classrooms in the tropics. *Energy and buildings*, 2003. 35(4): p. 337-351.
- [7] Bluyssen, P.M., D. Zhang, S. Kurvers, M. Overtoom, and M. Ortiz-Sanchez, Self-reported health and comfort of school children in 54 classrooms of 21 Dutch school buildings. *Building and Environment*, 2018. 138: p. 106-123.
- [8] Standard, A.S.H.R.A.E., Standard 55-2017 Thermal Environmental Conditions for Human Occupancy, *American Society of Heating, Refrigerating and Air conditioning Engineers: Atlanta, GA, USA*, 2017.
- [9] Fanger, P.O., Human requirements in future air-conditioned environments. *International Journal of Refrigeration*, 2001. 24(2): p. 148-153.
- [10] Wyon, D.P., Individual control at each workplace: the means and the potential benefits. Creating the productive workplace, 2000: p. 192-206.
- [11] Bauman, F., A. Baughman, G. Carter, and E.A. Arens, A field study of PEM (Personal Environmental Module) performance in Bank of America's San Francisco office buildings. 1997.
- [12] Pasut, W., H. Zhang, E. Arens, and Y. Zhai, Energy-efficient comfort with a heated/cooled chair: Results from human subject tests. *Building and Environment*, 2015. 84: p. 10-21.
- [13] Luo, M., E. Arens, H. Zhang, A. Ghahramani, and Z. Wang, Thermal comfort evaluated for combinations of energy-efficient personal heating and cooling devices. *Building and Environment*, 2018. 143: p. 206-216.
- [14] Zhang, H., E. Arens, and Y. Zhai, A review of the corrective power of personal comfort systems in non-neutral ambient environments. *Building and Environment*, 2015. 91: p. 15-41.
- [15] Melikov, A.K., M. Skwarczynski, J. Kaczmarczyk, and J. Zabecky, Use of personalized ventilation for improving health, comfort, and performance at high room temperature and humidity. *Indoor Air*, 2013. 23(3): p. 250-263.
- [16] Yang, B., S. Sekhar, and A.K. Melikov, Ceiling-mounted personalized ventilation system integrated with a secondary air distribution system—a human response study in hot and humid climate. *Indoor Air*, 2010. 20(4): p. 309-319.
- [17] Zhang, Y. and R. Zhao, Effect of local exposure on human responses. *Building and Environment*, 2007. 42(7): p. 2737-2745.
- [18] Taub, M., H. Zhang, E. Arens, F. Bauman, D. Dickerhoff, M. Fountain, W. Pasut, D. Fannon, Y. Zhai, and M. Pigman, The use of footwarmers in offices for thermal comfort and energy savings in winter. 2015.
- [19] Zhang, Y.F., D.P. Wyon, L. Fang, and A.K. Melikov, The influence of heated or cooled seats on the acceptable ambient temperature range. *Ergonomics*, 2007. 50(4): p. 586-600.
- [20] de Korte, E.M., M. Spiekman, L. Hoes-van Oeffelen, B. van der Zande, G. Vissenberg, G. Huiskes, and L.F.M. Kuijt-Evers, Personal environmental control: Effects of pre-set conditions for heating and lighting on personal settings, task performance and comfort experience. *Building and Environment*, 2015. 86: p. 166-176.
- [21] Parkinson, T. and R. de Dear, Thermal pleasure in built environments: spatial alliesthesia from contact heating. *Building Research & Information*, 2016. 44(3): p. 248-262.
- [22] Bluyssen, P.M., F. van Zeist, S. Kurvers, M. Tenpierik, S. Pont, B. Wolters, L. van Hulst, and D. Meertins, The creation of SenseLab: a laboratory for testing and experiencing single and combinations of indoor environmental conditions. *Intelligent Buildings International*, 2018. 10(1): p. 5-18.

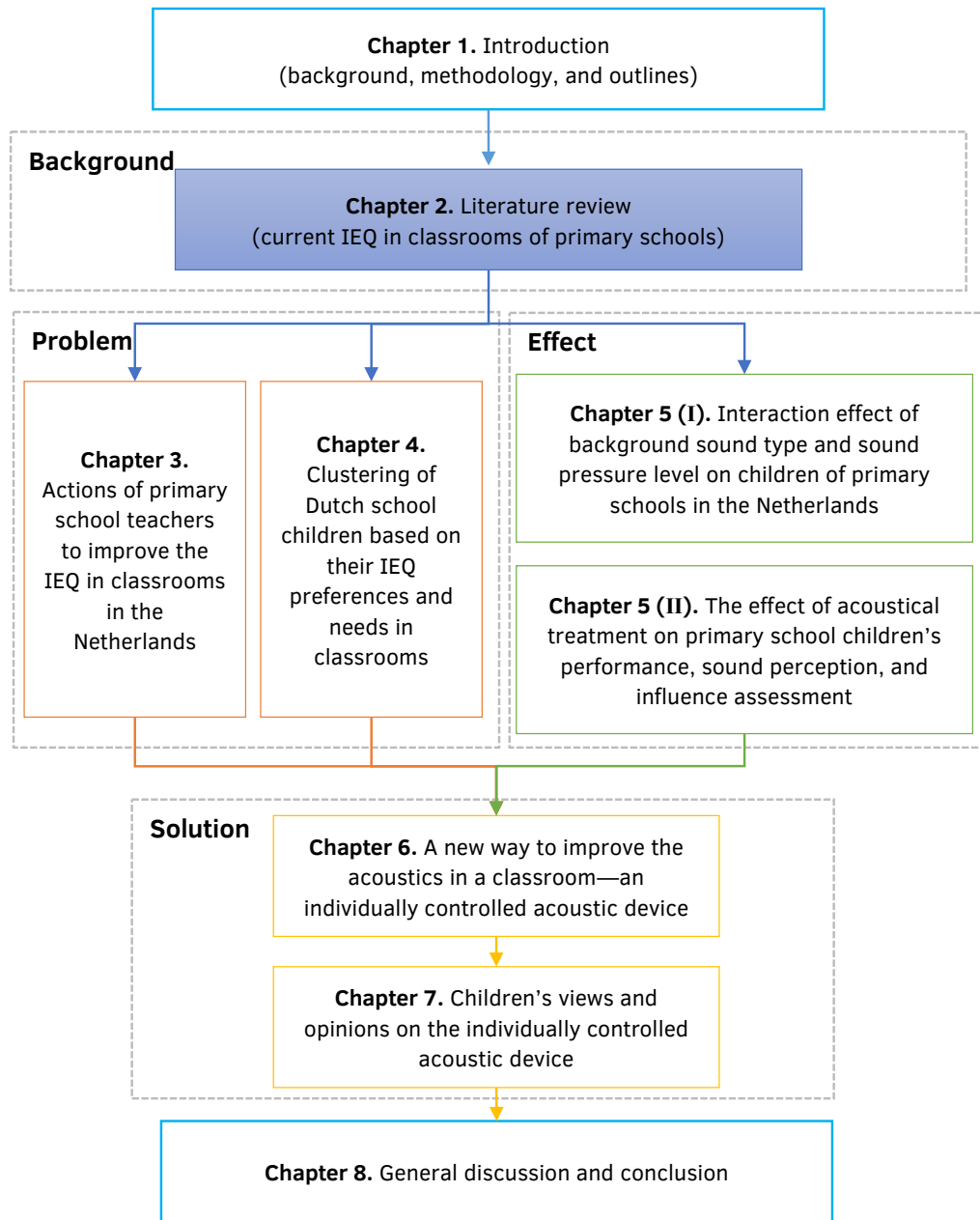

2 Literature review

This chapter is a state-of-the-art review that provides crucial background information for the whole project, indicates the knowledge gaps, and points out trends for future studies. The first two sections of the results introduce the current state of the IEQ in primary school classrooms and its impact on school children, while the next two sections categorize the current studies about the effect of individual control. Then the IEQ problems in classrooms of primary schools are discussed and more effective solutions are proposed.

This chapter is partly based on a paper that was presented at the Healthy Buildings Conference 2017 in Lublin, Poland and that has been published as follows: Zhang, D., Kurvers, S., Keyson, D. & Bluysen, P. M., 2017. Local control of IEQ in classrooms: what do we know? Proceedings Healthy Buildings 2017-Europe. 7 p. 0033. The layout has been adjusted to fit the style of this thesis.

ABSTRACT Good indoor environmental quality (IEQ) in classrooms is an essential requirement to ensure children's comfort and learning performance. However, although in many studies the IEQ in classrooms has been investigated, few or no studies have been focused on the way to ameliorate it. Recently, some researchers managed to utilize individual control to improve local IEQ, but most of these studies were focused on offices. Existing knowledge about how to apply individual control of IEQ in the classroom is very limited. This chapter presents a summary of knowledge in both fields of IEQ in classrooms and individual control. In addition, current issues relating to IEQ in classrooms are discussed and new problems are identified. All of these discussions show the need for further research on how to use individual control to improve the IEQ in classrooms to facilitate children's health and performance.

2.1 Introduction

It is well known that IEQ can have a significant impact on occupants' comfort, health and performance [1-4]. This impact has often been observed in classrooms. Up to now, although many investigations about IEQ in classrooms have been conducted, still many problems exist, such as noise, thermal discomfort, poor air quality and concentration loss in classrooms [5]. A recent study in 54 classrooms showed among others that 87% of the children were bothered by noise (mostly created by themselves) and 63% were bothered by smell (mostly created by themselves) [6]. In order to get an optimum IEQ, information is needed about the school children's interactions with and responses to IEQ, and how it affects their school performance and comfort experience.

In today's indoor environments, most designers strive to achieve optimal comfort conditions regarding lighting, ventilation, air quality and acoustics on a general level or at room level. However, to provide the best comfort experience for each occupant, customized settings on a local, personal level seem needed. Increasingly, the concept of individual control is being developed and evaluated [7]. Although there are few or no studies about applying individual control in classrooms, many studies about individually controlled devices used in office buildings could be used as reference.

Therefore, a literature study about the current condition, impact, and solutions of IEQ in classrooms, and the development and impact of individual control was performed. According to these findings, the directions for future research were identified.

2.2 Methods

Scope

This review contains two parts, the first part comprises the current state of IEQ in classrooms, its impact on students' comfort and performance, and the conventional solutions used to improve IEQ. In the first part, results are presented from the point of view of four IEQ aspects: IAQ, thermal quality, visual quality and acoustical quality.

The second part is focused on the individual control of IEQ. Because there are no or only a few studies that consider individual control in classrooms, the second part summarizes mainly studies about individual control of IEQ in offices.

Keywords

As mentioned before, IEQ and individual control are the focus of this study. For each, several keywords were used during the literature search. As shown in Table 2.1, in the category of IEQ, 'air quality', 'thermal quality', 'visual quality' and 'acoustical quality' were the specific keywords, while in the category of control, 'individual control', 'personal control', and 'local control' were the keywords used for the literature search. Moreover, there is another category about the location where these studies were carried out, for example, school, classroom or office. Usually, the combination of keywords from at least two of these categories were used to search the literature.

TABLE 2.1 The keywords used to search literatures.

Categories	IEQ	Control	Environment
Keywords	Air quality	Personal control	Primary school
	Thermal quality	Individual control	Classroom
	Visual quality	Local control	Office
	Acoustical quality		

Database

The literature study was based on a search through several electronic databases, such as TU Delft library, Web of Science, Engineering Village and the American Society of Heating, Refrigerating and Air-conditioning Engineers (ASHRAE). The reviewed journal papers covered not only IEQ in classrooms, but also in offices. Also, individual control over IEQ was used as a search input. In addition to the databases search, several papers were manually selected through relevant journals, such as the journal Indoor Air, Building and Environment, Indoor and Built Environment and so on.

2.3 Results

In this study, most of the reviewed papers focused on studies concerned with a single factor of IEQ, i.e. IAQ, thermal quality, acoustical quality or lighting quality. These papers include studies on current IEQ conditions in classrooms, studies on the impact of IEQ on students' health, comfort, and performance, and studies on current IEQ-improving solutions. In addition to these IEQ-related studies, papers about individual control, including the concept of individual control, the development of individually controlled devices, and the effectiveness of individual control, were also included.

2.3.1 Current condition of IEQ in classrooms

School children spend a large part of most days at school. However, the IEQ in the classrooms seems not as good as it should be. There exist very few schools that are designed to create the healthiest and most effective learning environment for students [8]. The large majority of schools is built not to optimize health and comfort, but rather to achieve a minimum required level of design performance at the lowest cost [9]. A report about the costs and benefits of green schools indicated that schools of 55 million students in the US were often unhealthy and had detrimental effect on students' learning ability [9].

Actually, this isn't a new phenomenon, some indoor environment related problems, such as overheating or undercooling, glare, poor IAQ, and noise, have been found as early as the mid-1990s [10]. Previous studies indicate that more than 60% of acoustical conditions in schools are inappropriate and school children are exposed to noises that are higher than the recommended levels. This is caused by the low-quality of the new building materials used in structures having poor insulation, especially those used in doors and windows, outdoor sources of noise and inappropriate material of interior surfaces with regard to the acoustic absorption [11].

After the Parma Declaration of the World Health Organization (WHO), indoor environmental problems related to children's health are taken more seriously, especially in Europe. During that conference, the Ministers and Representatives of Member States in the European Region of the WHO stated clearly that in the future the WHO will strive to realize their goals made in the previous ministerial conferences, especially those about children's environment and health [12].

So, what are the current IEQ-conditions in classrooms? Integrated studies of IEQ in classrooms are lacking since most studies and practices have focused on single components of IEQ in classrooms. According to a study conducted in Finnish elementary school buildings [13], noise and poor IAQ were the most common factors that caused both daily or weekly inconvenience. Other studies found that the IEQ in classrooms was affected by many building-related factors, such as the location, maintenance and cleaning of the building [14], and building type, age, and construction materials [13]. Besides, it was also influenced by indoor pollutants, like moulds, volatile organic compounds (VOCs), and formaldehyde [15]. However, these studies were not comprehensive enough. Therefore, recently a study was performed that included all of the IEQ-factors [2]. This study showed that different children can have different IEQ-related complaints, and that they were mostly bothered by noise created by themselves in their classrooms.

2.3.2 **The impact of IEQ on students' health, comfort, and performance**

There is enough evidence in the literature to show that all aspects of IEQ are likely to have an effect on students' comfort and performance and it is probably true in all classrooms all over the world [5]. Among all of the aspects of indoor environment, the impact of IAQ has been given most concern, many indoor polluting sources have been measured and their impact on school children's health have been found [10-12]. Several common IAQ-problems, such as mould, dampness [16] and high carbon dioxide (CO₂) concentration [17], have occurred in many schools. Several investigations into IAQ have shown that the an increase of absenteeism among students was associated with the increase of CO₂ concentration, and visible mould [16, 18].

The influence of thermal quality has been studied for many years, a few studies about the relationship between room temperature and students' comfort and performance were conducted almost 50 years ago [19, 20]. It has been acknowledged in several studies that thermal discomfort has a negative effect on students' school performance [2, 21]. However, many other investigations have demonstrated that students have a high degree of adaptability in thermal sensation even when the outdoor temperature was higher [22-24] or lower [25, 26] than normal. Also, in general, the adaptive comfort temperature of children was lower than of adults [27, 28].

For the acoustical studies, both internal and external noise has been investigated. The main identified external sources were cars, aircraft and trains [29-32]. These results have shown a remarkable clear ranking from trains to cars to aircraft, in relation to the negative impact on children's long-term memory that increased significantly with that ranking [31]. Exposure to traffic noise may also impair children's cognitive development, especially reading comprehension [33, 34]. Moreover, long-term exposure to road or aircraft noise may have detrimental effects on health. WHO indicated that chronic exposure to road noise is a risk factor for ischemic heart disease, and both road traffic noise and aircraft noise are risk factors for hypertension [34]. Although it seems that more attention has been given by researchers to traffic noise, internal generated noise has been found to be the main source of noise in classrooms [6, 35]. Studies about internal noise have been mainly focused on speech babble, equipment noise or other background noises in classrooms [36-38]. It has been found that children's performance on verbal tasks was worse in the babble condition, while their performance on speed of proceeding tasks was worse in the condition with both babble and background noise [38]. Less evidence for the association between internal noise and children's health has been found, possible because of a lack of studies. Apart from noise, the reverberation time (RT) in classrooms also has been found to have a strong relationship with children's performance. For example, Klatte et al. demonstrated that children in classrooms with a long RT had a lower score on phonological processing tasks [39]. However, no impact of RT was found in a silent environment [40]. The correlation between RT and children's task performance also was identified in a field study conducted by Braat-Eggen et al [41]. The results of their study indicated that the longer RT could had more detrimental impact on students' task performance.

In addition, several types of lighting (e.g. daylight [42], focussing light [43], ultraviolet light [44] and full-spectrum light [45]) have been studied to assess the relationship between visual quality in classrooms and students' performance. The results showed that daylight led to a 5-14% better school performance than artificial light [42]. For artificial light, it was found that direct lighting performed worse than other electrical lighting systems; it caused more eyestrain, visual fatigue and headaches [46]. Focussing light worked better than normal lighting in terms of their effect on oral reading performance [43], and full-spectrum lighting with ultraviolet supplements was highly beneficial to students' achievement and health [45].

2.3.3 Conventional solutions to improve IEQ

In general, IEQ is influenced by two main aspects, namely building characteristics and occupants' behaviour. Consequently, changing or adapting building characteristics by design or renovation (such as enlarging glazing area or changing ventilation systems) [47] or by actions performed by occupants related to building elements (such as opening/closing windows or turning on/off lights) are the two most common ways to improve IEQ. Nevertheless, research on occupants' behaviour in classrooms is limited [48]. In terms of IEQ-improvement, building design and renovation seemed to have the highest priority, while most of the improvements focused on one factor of IEQ (indoor air, thermal, visual or acoustical quality).

With regard to the improvement of IAQ, source control, increased ventilation, and cleaning of the air are the three basic strategies [49, 50]. Source control, a cost-efficient and effective method, can be realised by selecting low-emission building materials [51]. However, it is in general not suitable for existing buildings in which materials are already fixed. Therefore, increasing outdoor air supply to dilute indoor air pollutants have been given more attention. Both strategies can significantly reduce the concentration of pollutants [52, 53], but only increased ventilation was found to have a positive association with school performance [52, 54]. In classrooms, usually the major indoor pollution source is the occupant, and not the building materials or systems. It should be noted that although increased ventilation has been shown to improve IAQ, it also increases energy consumption.

Optimisation of the heating ventilation and air conditioning (HVAC)-system is a commonly used method to improve thermal quality. However, theoretically, although the optimized conventional HVAC-system could improve the indoor thermal quality to meet the requirements, it cannot guarantee a 100% satisfaction because of occupants' different preferred temperatures [55, 56].

RT is one of the crucial factors to measure the acoustical quality. According to a study conducted by Bistafa and Bradley, the RT of classrooms could have significant impact on speech intelligibility, and the 100% speech intelligibility can be achieved if the RT was controlled in a particular range [57]. Nijs and Rychtarikova also found similar results [58]. Both of these two studies recommended that the RT should be kept around 0.4s to achieve good speech intelligibility. In order to get a proper RT, installing acoustical ceiling tiles is the most common method [59-61]. However, a recent acoustic renovation study showed that ceiling materials did not have much influence on acoustics, especially when the ceiling was high [62]. A similar result was found in a field study conducted in Dutch primary schools: even though almost all the classrooms had acoustical ceiling tiles, most of the children there were bothered by noise [6].

Providing enough daylight and choosing a proper lighting system are the two general suggestions for improving the indoor visual quality [63]. However, there is a risk that daylight may cause glare, which is difficult to avoid since different people have different glare perception [64]. In addition, the amount of energy a lighting system uses is a problem [65].

2.3.4 Individual control

Conventional ways to improve IEQ are usually provided on classroom level and disregard individual differences. Consequently, there is always a small number of school children who endure an uncomfortable environment which may adversely affect their health and performance. To solve this problem, the concept of 'individual control' has been put forward. With individual control, each occupant can adjust their local environment by themselves. According to Wyon, the ability to change something is the best solution and this may result in 100% satisfaction [66].

In reference to the concept of control, many models have been proposed. For example, Paciuk [67] came up with a conceptualized control model to describe the relationship among available control, behaviour and satisfaction. Allen and Greenberger [68] explored the relationship between perceived control and behaviour that modified physical environment, and concluded that perceived control could be both the cause and the effect of destruction. Fisher's control model claimed that motivating the key members should be the focus of control system design [69].

Until now, many individually controlled devices have been studied [70-76]. It should be noted here that in different studies these individually controlled devices might be named slightly differently, such as Personal comfort systems (PSC), Personal environmental control system (PEC). Based on these studies, these devices can be generalized as follows:

Personal ventilation [71, 77, 78]: This device can be considered as micro air conditioning that could deliver heated/cooled clean air directly to an individual. It has the potential to improve the local air quality because it provides the clean air directly to the breathing zone of occupants and protects them from airborne transmission of polluted air. Besides, it could improve the thermal sensation since each occupant has the opportunity to be able to change the temperature and airflow rate based on their preferences and needs.

Heated or cooled or ventilated chairs [75, 79, 80]: This is a common individually controlled device, and can be found in many modern offices. The mechanism used for these chairs is not complicated: usually, these chairs are equipped with warm water tubes, isothermal air convection, or fans. Many investigations have proved that the application of these chairs could improve satisfaction, extending the acceptable ambient temperature range and reducing energy consumption.

Local radiant heating [74, 81, 82]: These devices were designed to provide overall thermal comfort by only heating the thermally sensitive parts of the human body, such as feet, hands or legs. These devices can improve occupants' thermal sensation effectively because the extremities (hands and feet) are most susceptible to temperature, and they are not easy to be heated by traditional heating devices (like radiators or central air-condition).

Task-ambient light [83-85]: This refers to a lighting system that comprises of an ambient light module that provides background or decorative light and a task lighting module that is suitable for office work or study. It can provide the exact amount of light required to perform tasks and enhance visual comfort. Moreover, it could save around 20% energy since the ambient light level of the surrounding environment can be lower.

2.3.5 The effect of individual control

In order to understand and quantify the benefits of individually controlled devices, several related studies were reviewed. Given the fact that recent research about the individually controlled devices used in classrooms is very limited, the scope of the classroom environment was set aside. The focus was put on the office environment because the occupants there are “knowledge workers”, and the actions they do, such as reading, synthesising information, writing, calculating, and communicating, are very similar to the work school children do. Several large-scale studies have indicated the relationship between individual control and performance of workers in many non-academic institutions, the results of which are also relevant for schools.

In one study the effect of individually controlled temperature and ventilation among 11,000 workers from 107 European buildings was analysed [86]. The outcome indicated that workers who can control the temperature and ventilation had higher work efficiency and less chance of illness and absenteeism. On the contrary, workers whose workplace lacked these controls were less productive. A similar result was also identified by Humphrey and Nicol in a field study, during which they found that

providing enough individual control of local environment could improve occupants' comfort and thereby enhance productivity [87]. By comparing occupants' satisfaction and perceived control level in buildings with or without mechanical ventilation, Toftum also found that the more control people have, the more satisfied they feel [88].

Additionally, several individually controlled devices have been developed in the last decades. These devices were able to significantly increase the occupants' comfort satisfaction [79, 89]. In terms of thermal comfort, even 100% satisfaction could be achieved by using these devices in each workplace [90]. An explanation can be that individual differences are taken into consideration when designing individually controlled devices, and a highly customized local environment can be provided to each occupant to meet their requirements without disturbing others in the same room.

2.4 Discussion

2.4.1 Problems of the IEQ in primary school classrooms

Many indoor pollution sources have been observed in classrooms and several relationships between those sources and students' health have been found. For example, VOCs and NO₂ were associated with wheezing at night; benzene and xylenes were associated with allergies [91]; CO and O₃ had a strong correlation with absenteeism [92] and particulate matter (PM) had a correlation with certain health symptoms [93]. Although the importance of good IAQ in classroom is well-known, how to improve it to satisfy every school child is still a problem.

Results of thermal comfort studies indicate that students generally accept cool thermal sensations more readily than warm thermal sensations [22] and they suffer less from headaches at a lower temperature [2]. Besides, a survey conducted by Zeiler & Boxem gave evidence that there are large individual differences in thermal comfort perception [94]. So, the temperature setting should be designed individually instead of on classroom level.

For the acoustical part, many different types of noise have been found in classrooms. Results of the related studies indicated that no matter what type of noise, it can have an adverse impact on students' performance [29, 31, 32, 37]. Although some solutions, such as acoustical suspended ceilings, wall absorbers [95] and absorbing flooring materials [96], are being explored, an individual method to have control over noise is still uncommon.

The problem concerning visual quality in classrooms is that current classrooms mainly depend on natural light which is changing all the time. So the amount of light on the desk, especially the desk near a window is quite unstable. Also, the flicker caused by fluorescent lighting and the glare introduced by daylight or by interactive whiteboards could cause visual discomfort and impair children's cognitive performance [63].

In conclusion, the common problem that exists for the four aspects is that the classroom environment is traditionally designed at room level. School children feel uncomfortable for having no possibilities to change these conditions by themselves [25, 43].

2.4.2 What could be an effective solution?

There are many solutions to the problems mentioned above, such as installing a high performance heating ventilation and air-conditioning (HVAC) system, increasing the use of natural light, or choosing artificial light. However, these solutions either may cause more energy consumption or cannot ensure a high level of school children's satisfaction. According to the study conducted by Wyon et al., the best solution is providing school children with an individually controlled device with possibilities to adjust their own local environment [66]. However, our understanding of the effect of individual control in classrooms is limited, but the effect of some similar systems used in offices has already been investigated, which can be used as reference. At present, the positive effect of some individually controlled systems on adults, such as the Individual Microclimate Control Devices (IMCDs), the Personal Ventilation (PV) systems, and the Task-Ambient Conditioning system, has already been demonstrated by Wyon et al. [66], Melikov et al. [97] and Zhang et al. [98].

Results from these studies showed that occupants with a higher degree of control over their thermal, visual and acoustical environment are much more satisfied with their environment [99, 100]. The same effect is also expected to occur for children and their performance of schoolwork. In this context, applying individual control to classrooms appears to be an effective solution to improve school children's IEQ perception, comfort, and even performance. However, a survey conducted by Teli

et al. suggested that children have a different thermal perception than adults and adjustments, therefore, are required to design the individually controlled devices used in classrooms in order to satisfy school children effectively [28].

2.5 Conclusion

Although many studies have been conducted to investigate IEQ in classrooms and many methods have been developed to improve it, several IEQ-related problems still exist and these problems could lead to an unhealthy and uncomfortable learning environment and further affect children's health and school performance. To improve IEQ and the occupants' satisfaction rate, individual control, as a new research direction, has been put forward. Some previous studies have designed and tested several individually controlled devices, but all of these devices were designed for adults, and the performance tests of these systems in real workplaces, especially in classrooms, is limited. To identify the potential effect of individual control on performance and comfort of school children, there is a need to clarify their interaction with them. To design a practical control system, the ranges of some important characteristics should be determined. Information on students' preferred values of this system and how it affects their school performance and comfort experience should be collected in further studies.

References

- [1] Toftum, J., B.U. Kjeldsen, P. Wargocki, H.R. Menå, E.M. Hansen, and G. Clausen, Association between classroom ventilation mode and learning outcome in Danish schools. *Building and Environment*, 2015. 92: p. 494-503.
- [2] Wargocki, P. and D.P. Wyon, The effects of moderately raised classroom temperatures and classroom ventilation rate on the performance of schoolwork by children (RP-1257). *Hvac&R Research*, 2007. 13(2): p. 193-220.
- [3] Shield, B.M. and J.E. Dockrell. The Effects of classroom and environmental noise on children's academic performance. in *9th International Congress on Noise as a Public Health Problem (ICBEN)*, Foxwoods, CT. 2008.
- [4] Heschong, L., Daylighting and human performance. *ASHRAE Journal*, 2002. 44(6): p. 65.
- [5] Bluysen, P.M., Health, comfort and performance of children in classrooms—new directions for research. *Indoor and Built Environment*, 2017. 26(8): p. 1040-1050.
- [6] Bluysen, P.M., D. Zhang, S. Kurvers, M. Overtoom, and M. Ortiz-Sanchez, Self-reported health and comfort of school children in 54 classrooms of 21 Dutch school buildings. *Building and Environment*, 2018. 138: p. 106-123.
- [7] Watanabe, S., A.K. Melikov, and G.L. Knudsen, Design of an individually controlled system for an optimal thermal microenvironment. *Building and Environment*, 2010. 45(3): p. 549-558.
- [8] Johnson, P.D. and W.A. Kritsonis, Greener Schools, Greater Learning, and the LEED Value. *Online Submission*, 2010. 7(1).
- [9] Kats, G., Greening America's Schools, *iAmerican Federation of Teachers, et al. Capital E*, 2006.
- [10] Frumkin, H., R.J. Geller, and J. Nodvin, Safe and healthy school environments. 2006: *Oxford University Press*.
- [11] Gilavand, A., Investigating the Impact of Environmental Factors on Learning and Academic Achievement of Elementary Students: Review. *Int J Med Res Health Sci*, 2016. 5: p. 360-369.
- [12] WHO. Parma declaration on Environment and Health. in *Fifth Ministerial Conference on Environment and Health. Protecting children's health in a changing environment. Parma, Italy*. 2010.
- [13] Turunen, M., O. Toyinbo, T. Putus, A. Nevalainen, R. Shaughnessy, and U. Haverinen-Shaughnessy, Indoor environmental quality in school buildings, and the health and wellbeing of students. *International journal of hygiene and environmental health*, 2014. 217(7): p. 733-739.
- [14] US EPA. Building Air Quality Guide: A Guide for Building Owners and Facility Managers. 2010; Available from: www.epa.gov/indoor-air-quality-iaq/building-air-quality-guide-guide-building-owners-and-facility-managers.
- [15] Zhao, Z., Z. Zhang, Z. Wang, M. Ferm, Y. Liang, and D. Norbäck, Asthmatic symptoms among pupils in relation to winter indoor and outdoor air pollution in schools in Taiyuan, China. *Environmental health perspectives*, 2008. 116(1): p. 90-97.
- [16] Haverinen-Shaughnessy, U., A. Borrás-Santos, M. Turunen, J.P. Zock, J. Jacobs, E. Krop, L. Casas, R. Shaughnessy, M. Täubel, and D. Heederik, Occurrence of moisture problems in schools in three countries from different climatic regions of Europe based on questionnaires and building inspections—the HITEA study. *Indoor Air*, 2012. 22(6): p. 457-466.
- [17] Madureira, J., M. Alvim-Ferraz, S. Rodrigues, C. Gonçalves, M. Azevedo, E. Pinto, and O. Mayan, Indoor air quality in schools and health symptoms among Portuguese teachers. *Human and Ecological Risk Assessment*, 2009. 15(1): p. 159-169.
- [18] Simons, E., S.-A. Hwang, E.F. Fitzgerald, C. Kielb, and S. Lin, The impact of school building conditions on student absenteeism in upstate New York. *American journal of public health*, 2010. 100(9): p. 1679-1686.
- [19] Pepler, R.D. and R. Warner, Temperature and learning: an experimental study. *Ashrae Transactions*, 1968. 74(2): p. 211-219.
- [20] Auliciems, A., Thermal requirements of secondary schoolchildren in winter. *Journal of Hygiene*, 1969. 67(01): p. 59-65.
- [21] Mendell, M.J. and G.A. Heath, Do indoor pollutants and thermal conditions in schools influence student performance? A critical review of the literature. *Indoor Air*, 2005. 15(1): p. 27-52.
- [22] Wong, N.H. and S.S. Khoo, Thermal comfort in classrooms in the tropics. *Energy and buildings*, 2003. 35(4): p. 337-351.
- [23] Kwok, A.G. and C. Chun, Thermal comfort in Japanese schools. *Solar Energy*, 2003. 74(3): p. 245-252.

- [24] Liang, H.-H., T.-P. Lin, and R.-L. Hwang, Linking occupants' thermal perception and building thermal performance in naturally ventilated school buildings. *Applied Energy*, 2012. 94: p. 355-363.
- [25] De Giuli, V., O. Da Pos, and M. De Carli, Indoor environmental quality and pupil perception in Italian primary schools. *Building and Environment*, 2012. 56: p. 335-345.
- [26] Yang, B., T. Olofsson, F. Wang, and W. Lu, Thermal comfort in primary school classrooms: A case study under subarctic climate area of Sweden. *Building and Environment*, 2018. 135: p. 237-245.
- [27] de Dear, R., J. Kim, C. Candido, and M. Deuble, Adaptive thermal comfort in Australian school classrooms. *Building Research & Information*, 2015. 43(3): p. 383-398.
- [28] Teli, D., M.F. Jentsch, and P.A.B. James, Naturally ventilated classrooms: An assessment of existing comfort models for predicting the thermal sensation and preference of primary school children. *Energy and Buildings*, 2012. 53: p. 166-182.
- [29] Evans, G.W. and L. Maxwell, Chronic Noise Exposure and Reading Deficits The Mediating Effects of Language Acquisition. *Environment and Behavior*, 1997. 29(5): p. 638-656.
- [30] Shield, B.M. and J.E. Dockrell, The effects of noise on children at school: a review. *Building Acoustics*, 2003. 10(2): p. 97-116.
- [31] Hygge, S., Classroom experiments on the effects of different noise sources and sound levels on long-term recall and recognition in children. *Applied Cognitive Psychology*, 2003. 17(8): p. 895-914.
- [32] Haines, M.M., S.A. Stansfeld, R.F.S. Job, B. Berglund, and J. Head, Chronic aircraft noise exposure, stress responses, mental health and cognitive performance in school children. *Psychological Medicine*, 2001. 31(02).
- [33] Clark, C., J. Head, and S.A. Stansfeld, Longitudinal effects of aircraft noise exposure on children's health and cognition: a six-year follow-up of the UK RANCH cohort. *Journal of Environmental Psychology*, 2013. 35: p. 1-9.
- [34] WHO, Burden of disease from environmental noise -- Quantification of healthy life years lost in Europe. 2011.
- [35] Shield, B., J. Dockrell, R. Asker, and I. Tachmatzidis, The effects of noise on the attainments and cognitive development of primary school children, in *Final report for Department of Health DETR*. 2002.
- [36] Shield, B. and J. Dockrell, The effects of environmental noise on child academic attainments. *Proceedings of the Institute of Acoustics*, 2002. 24(6).
- [37] Ronse, L.M. and L.M. Wang, Relationships between unoccupied classroom acoustical conditions and elementary student achievement measured in eastern Nebraska. *The Journal of the Acoustical Society of America*, 2013. 133(3): p. 1480-1495.
- [38] Dockrell, J.E. and B.M. Shield, Acoustical barriers in classrooms: The impact of noise on performance in the classroom. *British Educational Research Journal*, 2006. 32(3): p. 509-525.
- [39] Klatte, M., J. Hellbrück, J. Seidel, and P. Leistner, Effects of classroom acoustics on performance and well-being in elementary school children: A field study. *Environment and Behavior*, 2010. 42(5): p. 659-692.
- [40] Klatte, M., T. Lachmann, and M. Meis, Effects of noise and reverberation on speech perception and listening comprehension of children and adults in a classroom-like setting. *Noise and Health*, 2010. 12(49): p. 270.
- [41] Braat-Eggen, P.E., A. van Heijst, M. Hornikx, and A. Kohlrausch, Noise disturbance in open-plan study environments: A field study on noise sources, student tasks and room acoustic parameters. *Ergonomics*, 2017. 60(9): p. 1297-1314.
- [42] Nicklas, M.H. and G.B. Bailey, Student performance in daylit schools. *Innovative Design. Raleigh, North carolina*, 1996.
- [43] Mott, M.S., D.H. Robinson, A. Walden, J. Burnette, and A.S. Rutherford, Illuminating the effects of dynamic lighting on student learning. *Sage Open*, 2012. 2(2): p. 2158244012445585.
- [44] Wohlfarth, H., Colour and Light Effects on Students' Achievement, *Behavior and Physiology*. 1986.
- [45] Hathaway, W.E., Effects of school lighting on physical development and school performance. *The Journal of Educational Research*, 1995. 88(4): p. 228-242.
- [46] Grocoff, P.N., Electric Lighting and Daylighting in Schools. IssueTrak: A CEFPI Brief on Educational Facility Issues. 1995.
- [47] Hodgson, M., Case-study evaluations of the acoustical designs of renovated university classrooms. *Applied Acoustics*, 2004. 65(1): p. 69-89.
- [48] Zhang, D. and P.M. Bluysen, Actions of primary school teachers to improve the indoor environmental quality of classrooms in the Netherlands. *Intelligent Buildings International*, 2019. DOI: 10.1080/17508975.2019.1617100.

- [49] Bluysen, P.M., All you need to know about indoor air: a simple guide for educating yourself to improve your indoor environment. 2015: *Delft Academic Press*.
- [50] United States Environmental Protection Agency. Improving Indoor Air Quality. 2020; Available from: <https://www.epa.gov/indoor-air-quality-iaq/improving-indoor-air-quality>.
- [51] Guo, H., F. Murray, and S. Lee, The development of low volatile organic compound emission house—a case study. *Building and environment*, 2003. 38(12): p. 1413-1422.
- [52] Wargocki, P., Improving indoor air quality improves the performance of office work and school work. *Energy Systems Laboratory* (<http://esl.tamu.edu>), 2008.
- [53] Kim, S.-S., D.-H. Kang, D.-H. Choi, M.-S. Yeo, and K.-W. Kim, Comparison of strategies to improve indoor air quality at the pre-occupancy stage in new apartment buildings. *Building and Environment*, 2008. 43(3): p. 320-328.
- [54] Mattsson, M. and S. Hygge. Effect of particulate air cleaning on perceived health and cognitive performance in school children during pollen season. in *Proceedings of the 10th International Conference on Indoor Air Quality and Climate*. 2005. Tsinghua University.
- [55] Standard, A.S.H.R.A.E., Standard 55–2017 Thermal Environmental Conditions for Human Occupancy, in *American Society of Heating, Refrigerating and Air Conditioning Engineers: Atlanta, GA, USA*. 2017.
- [56] Hoof, J.V., Forty years of Fanger's model of thermal comfort: comfort for all? *Indoor Air*, 2008. 18(3): p. 182-201.
- [57] Bistafa, S.R. and J.S. Bradley, Reverberation time and maximum background-noise level for classrooms from a comparative study of speech intelligibility metrics. *The Journal of the Acoustical Society of America*, 2000. 107(2): p. 861-875.
- [58] Nijs, L. and M. Rychtáriková, Calculating the optimum reverberation time and absorption coefficient for good speech intelligibility in classroom design using U50. *Acta Acustica united with Acustica*, 2011. 97(1): p. 93-102.
- [59] Russo, D. and A. Ruggiero, Choice of the optimal acoustic design of a school classroom and experimental verification. *Applied Acoustics*, 2019. 146: p. 280-287.
- [60] Siebein, G.W. Understanding classroom acoustic solutions. in *Seminars in Hearing*. 2004.
- [61] Canning, D. and A. James, The Essex Study Optimised classroom acoustics for all. UK: *The Association of Noise Consultants*, 2012.
- [62] Chmelik, V., J. Kuran, and M. Rychtarikova, Optimization of a membrane structure design for existing project of children's playground in the city of Krupina. in *TensiNet Symposium 2019, Softening the habitats, 3-5 June 2019*, Politecnico di Milano.
- [63] Winterbottom, M. and A. Wilkins, Lighting and discomfort in the classroom. *Journal of environmental psychology*, 2009. 29(1): p. 63-75.
- [64] Hellinga, H., Daylight and View: The influence of windows on the visual quality of indoor spaces. 2013, *Delft University of Technology*.
- [65] Bernardo, H., C.H. Antunes, A. Gaspar, L.D. Pereira, and M.G. da Silva, An approach for energy performance and indoor climate assessment in a Portuguese school building. *Sustainable cities and society*, 2017. 30: p. 184-194.
- [66] Wyon, D.P., Individual control at each workplace: the means and the potential benefits. *Creating the productive workplace*, 2000: p. 192-206.
- [67] Paciuk, M., Personal Control of the Workspace Environment as Affected by Changing Concepts in Office Design. 1990.
- [68] Allen, V.L. and D.B. Greenberger, Destruction and perceived control. *Advances in Environmental Psychology*, 1980. 2: p. 85-109.
- [69] Fisher, J., Technological interdependence, labor production functions, and control systems. *Accounting, Organizations Society*, 1994. 19(6): p. 493-505.
- [70] Zhang, H., E. Arens, and Y. Zhai, A review of the corrective power of personal comfort systems in non-neutral ambient environments. *Building and Environment*, 2015. 91: p. 15-41.
- [71] Melikov, A.K., M. Skwarczynski, J. Kaczmarczyk, and J. Zabecky, Use of personalized ventilation for improving health, comfort, and performance at high room temperature and humidity. *Indoor Air*, 2013. 23(3): p. 250-263.
- [72] Yang, B., S. Sekhar, and A.K. Melikov, Ceiling-mounted personalized ventilation system integrated with a secondary air distribution system—a human response study in hot and humid climate. *Indoor Air*, 2010. 20(4): p. 309-319.

- [73] Zhang, Y. and R. Zhao, Effect of local exposure on human responses. *Building and Environment*, 2007. 42(7): p. 2737-2745.
- [74] Taub, M., H. Zhang, E. Arens, F. Bauman, D. Dickerhoff, M. Fountain, W. Pasut, D. Fannon, Y. Zhai, and M. Pigman, The use of footwarmers in offices for thermal comfort and energy savings in winter. 2015.
- [75] Zhang, Y.F., D.P. Wyon, L. Fang, and A.K. Melikov, The influence of heated or cooled seats on the acceptable ambient temperature range. *Ergonomics*, 2007. 50(4): p. 586-600.
- [76] de Korte, E.M., M. Spiekman, L. Hoes-van Oeffelen, B. van der Zande, G. Vissenberg, G. Huiskes, and L.F.M. Kuijt-Evers, Personal environmental control: Effects of pre-set conditions for heating and lighting on personal settings, task performance and comfort experience. *Building and Environment*, 2015. 86: p. 166-176.
- [77] Melikov, A.K., H. Groenegaard, and J.B. Nielsen, Personal Ventilation: from research to practical use. *Proceedings of CLIMA, Helsinki*, 2007.
- [78] Melikov, A.K., Personalized ventilation. *Indoor Air*, 2004. 14(s7): p. 157-167.
- [79] Pasut, W., H. Zhang, E. Arens, S. Kaam, and Y. Zhai, Effect of a heated and cooled office chair on thermal comfort. *HVAC&R Research*, 2013. 19(5): p. 574-583.
- [80] Pasut, W., H. Zhang, E. Arens, and Y. Zhai, Energy-efficient comfort with a heated/cooled chair: Results from human subject tests. *Building and Environment*, 2015. 84: p. 10-21.
- [81] Rønneseth, Ø., Personal Heating and Cooling Devices: Increasing Users' Thermal Satisfaction. A literature study. *ZEN Report*, 2018.
- [82] Verhaart, J., M. Veselý, and W. Zeiler, Personal heating: effectiveness and energy use. *Building Research & Information*, 2015. 43(3): p. 346-354.
- [83] Yamakawa, K., K. Watabe, M. Inanuma, K. Sakata, and H. Takeda, A study on the practical use of a task and ambient lighting system in an office. *Journal of Light & Visual Environment*, 2000. 24(2): p. 15-18.
- [84] Tabuchi, Y., K. Matsushima, and H. Nakamura, Preferred illuminances on surrounding surfaces in relation to task illuminance in office room using task-ambient lighting. *Journal of Light & Visual Environment*, 1995. 19(1): p. 28-39.
- [85] Bembridge, M.L., G.F. Watson, O.E. Pena, and S.L. Marzano, Luminaire combining ambient light and task light. 2016, Google Patents.
- [86] Heerwagen, J., Sustainable Design Can Be an Asset to the Bottom Line-expanded internet edition. *Environmental Design & Construction*, 2002.
- [87] Humphreys, M.A. and J.F. Nicol, Self-assessed productivity and the office environment: monthly surveys in five European countries. *ASHRAE transactions*, 2007. 113: p. 606.
- [88] Toftum, J., Central automatic control or distributed occupant control for better indoor environment quality in the future. *Building and environment*, 2010. 45(1): p. 23-28.
- [89] Kim, J., F. Bauman, P. Raftery, E. Arens, H. Zhang, G. Fierro, M. Andersen, and D. Culler, Occupant comfort and behavior: High-resolution data from a 6-month field study of personal comfort systems with 37 real office workers. *Building and Environment*, 2019. 148: p. 348-360.
- [90] Bauman, F., A. Baughman, G. Carter, and E.A. Arens, A field study of PEM (Personal Environmental Module) performance in Bank of America's San Francisco office buildings. 1997.
- [91] Csobod, E., P. Rudnai, and E. Vaskovi, School Environment and Respiratory Health of Children (SEARCH). *International research project report within the programme 'Indoor air quality in European schools: Preventing and reducing respiratory diseases.'*Regional Environmental Center for Central and Eastern Europe, Hungary. Assessed August, 2010. 29: p. 2012.
- [92] Chen, L., Jennison, B. L., Yang, W., & Omaye, S. T., Elementary school absenteeism and air pollution. *Inhalation Toxicology*, 2000. 12(11): p. 997-1016.
- [93] Dorizas, P.V., M.-N. Assimakopoulos, and M. Santamouris, A holistic approach for the assessment of the indoor environmental quality, student productivity, and energy consumption in primary schools. *Environmental monitoring and assessment*, 2015. 187(5): p. 1-18.
- [94] Zeiler, W. and G. Boxem, Effects of thermal activated building systems in schools on thermal comfort in winter. *Building and Environment*, 2009. 44(11): p. 2308-2317.
- [95] Campbell, C., C. Svensson, and E. Nilsson. The challenge of meeting both acoustic and thermal comfort in 21st century school classrooms. in INTER-NOISE and NOISE-CON Congress and Conference Proceedings. 2014. *Institute of Noise Control Engineering*.
- [96] Harris, D.D., The influence of flooring on environmental stressors: a study of three flooring materials in a hospital. *HERD*, 2015. 8(3): p. 9-29.

- [97] Melikov, A.K., R. Cermak, and M. Majer, Personalized ventilation: evaluation of different air terminal devices. *Energy and buildings*, 2002. 34(8): p. 829-836.
- [98] Zhang, H., E. Arens, D. Kim, E. Buchberger, F. Bauman, and C. Huizenga, Comfort, perceived air quality, and work performance in a low-power task–ambient conditioning system. *Building and Environment*, 2010. 45(1): p. 29-39.
- [99] Bauman, F.S., T.G. Carter, A.V. Baughman, and E.A. Arens, Field study of the impact of a desktop task/ ambient conditioning system in office buildings. *ASHRAE Transactions*, 1998. 104: p. 1 153.
- [100] Roulet, C.-A., N. Johner, F. Foradini, P. Bluysen, C. Cox, E. De Oliveira Fernandes, B. Müller, and C. Aizlewood, Perceived health and comfort in relation to energy use and building characteristics. *Building Research & Information*, 2006. 34(5): p. 467-474.

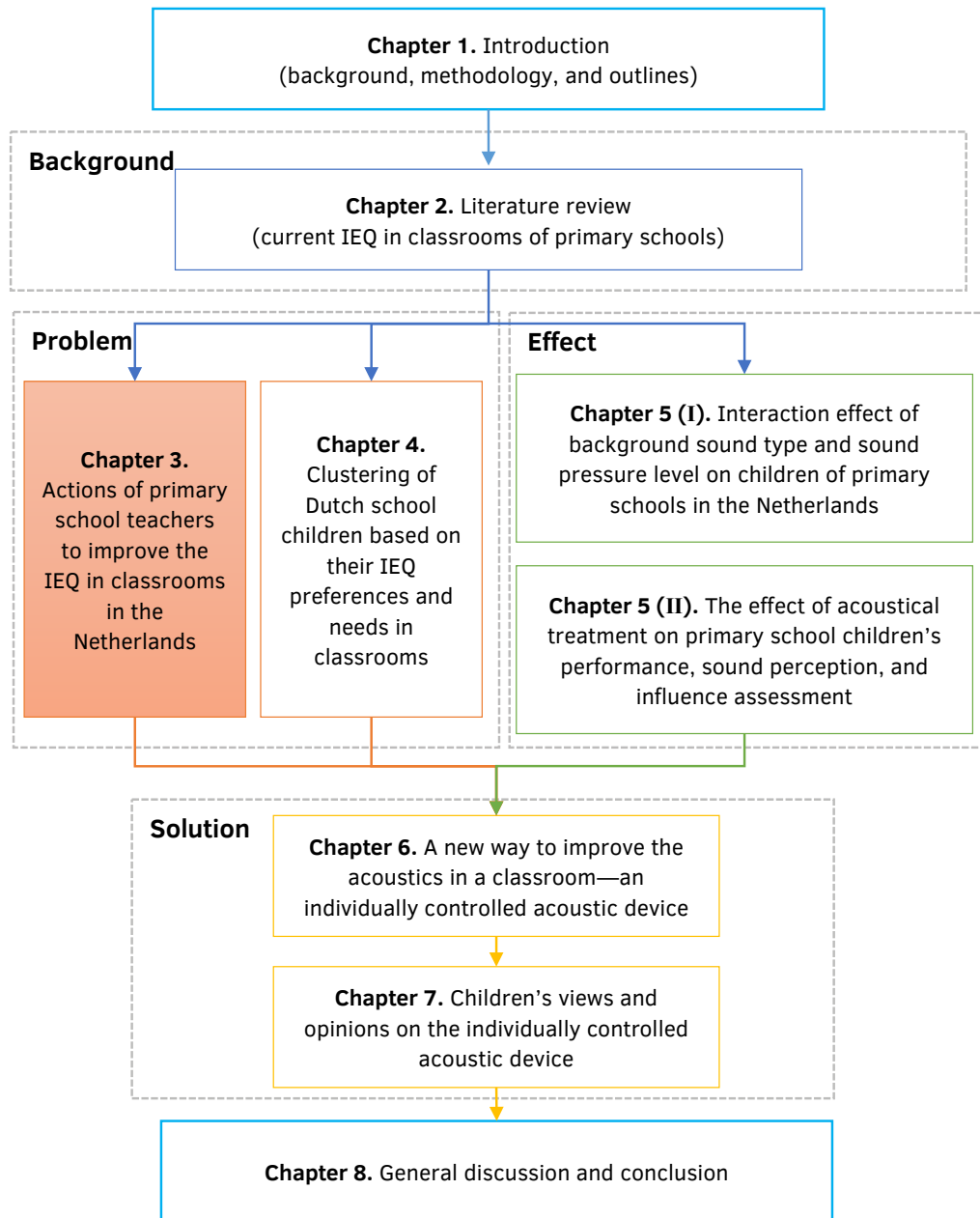

3 Actions of primary school teachers to improve the indoor environmental quality of classrooms in the Netherlands

The previous chapter introduced the current state of the IEQ in classrooms and pointed out many IEQ problems, such as stuffy air, noise, and lack of daylight. Undoubtedly, these problems have a negative impact on children's comfort and performance. However, the corresponding solutions are not clear. When children feel uncomfortable, the most common (or perhaps the only) thing they can do is to ask their teacher for help. In most classrooms, the teacher is the only one who can take actions to change the IEQ. But how well do these actions work? And how do these actions relate to children's requests? These questions have not been investigated before. Therefore, this chapter identifies what teachers usually do to improve IEQ in classrooms and how these actions relate to children's comfort perceptions and requests. The first part of the result describes children's comfort perceptions, their requests, and their teachers' actions. The second part addresses the relationships among these three subjects. These findings imply that although teachers want to help children and they do take actions based on children's requests, their actions seldom make children feel better.

This chapter has been published as follows: Dadi Zhang & Philomena M. Bluysen (2019): Actions of primary school teachers to improve the indoor environmental quality of classrooms in the Netherlands, Intelligent Buildings International, DOI: 10.1080/17508975.2019.1617100. The layout has been adjusted to fit the style of this thesis.

ABSTRACT Indoor environmental quality (IEQ) in classrooms can have an effect on school children's comfort, health, and performance. In most classrooms, the teacher is the only one who can take actions to change the IEQ. The objective of this study was to identify what teachers usually do to improve IEQ in classrooms and how these actions relate to children's comfort perceptions. A survey was carried out among 1,145 school children (9 to 12 years) in 21 primary schools (54 classrooms) in the Netherlands. Every child filled out a questionnaire about their comfort perception and every teacher filled out a questionnaire about their IEQ-improving actions and school children's requests to change the IEQ. The relations among children's comfort perceptions, their requests, and teachers' actions were analysed through t-tests and chi-squared tests. The most common action conducted by teachers was opening windows because of the "too warm" complaints. Correspondingly, the most frequent request of the children was opening/closing windows because of thermal discomfort. However, the teachers' actions did not have a significant impact on children's comfort perceptions, which means that teachers could not fulfil every child's needs in a classroom, even though teachers' actions did relate to the child's requests.

KEYWORDS children's perceptions; children's requests; teachers' actions; indoor environmental quality; primary school classrooms

3.1 Introduction

Poor IEQ (Indoor environmental quality) in classrooms is one of the main problems faced by many schools around the world [1-4]. Maintaining an acceptable IEQ in classrooms, which comprises air quality, thermal quality, visual quality and acoustical quality, has shown to have a significant impact on school children's health, comfort, and performance. An acceptable IEQ in classrooms has been proven to improve children's health and comfort, and reduce absenteeism [5, 6]. The IEQ

of classrooms is, to a large extent, determined by the interactions that take place between teachers and the children in those classrooms. Teachers play an important role in maintaining the IEQ in classrooms by taking actions such as opening/closing windows, turning on/off heaters, air conditioning, and lighting systems, and usually they are the only ones that can control the indoor environmental conditions.

IEQ in classrooms and its impact on school children has been a topic of research in numerous studies. Most of these studies put their focuses on the problems related to Indoor Air Quality (IAQ). For example, Haverinen-Shaughnessy et al. [7] found that moisture is a common problem in schools of the Netherlands, Spain and Finland, about 24% to 47% of schools in these countries reported moisture problems (such as moisture damage, dampness, and mould). Chatzidiakou, Mumovic, and Summerfield [8] found that there was a relationship between presence of moulds in classrooms and dissatisfaction with IAQ, temperature and relative humidity.

In addition, thermal quality in classrooms is also a popular topic, and in some studies, it was investigated together with IAQ. For example, Mendell and Heath [9] conducted a literature study about indoor pollutants and thermal conditions in schools and concluded that poor IAQ and thermal conditions are common in schools and have a negative impact on children's performance and attendance. Bako-Biro et al. [10] investigated the effects of ventilation rate on school children's performance in primary schools in England and established a relationship between low ventilation rates in classrooms and school children's attention and memory. Based on a field study conducted in 15 classrooms in a secondary school in Singapore, Wong and Khoo [11] pointed out that most school children prefer cool rather than warm environments. The same results were found by ter Mors et al. for school children in a field study on adaptive thermal comfort in primary schools in the Netherlands and suggested that the temperature in a classroom should be a few degrees lower than in an office [12].

Besides, acoustical quality emerged in the last decades. A common topic concerns the effect of typical classroom noise on school children's performance. Dockrell and Shield [13, 14] observed the effects of typical classroom noise on school children's literacy and speed tasks, and indicated different effects of different types of noise. For example, the noise from aircraft and road traffic affected children's long-term recall whereas the noise from train did not; and the interior classroom noise was found to affect children's reading ability. Additionally, the classroom acoustics also was a major topic of research. Klatte et al. [15] analysed the effects of classroom reverberation time on children's performance in 21 classrooms in Germany, and found that the children from the reverberant classrooms performed worse in a phonological processing task compared to children from less reverberant classrooms.

Last but not least, the visual quality is another considerable factor in relation to the IEQ in classrooms. Wu and Ng [16] reviewed the progress of daylighting in schools, identified the limitations of previous studies and concluded that future studies should focus on the relationship between occupants' perception and daylight quality. Hathaway [17] examined school children's health, attendance, and academic achievements under four different types of artificial light and identified non-visual effects of different types of lighting on school children.

These studies have provided many meaningful findings and conclusions, however, most of these studies just focused on one aspect of IEQ, and up to now, very few studies have considered the four aspects of IEQ as a whole [18]. Also, very few studies have investigated children's preferences and needs in terms of IEQ in classrooms, and/or included the children's suggestions to improve IEQ in their classrooms [19].

According to UNESCO, high-performance school buildings should not only be sustainable but also enable health, comfort and efficiency [20]. The United States Environmental Protection Agency (US EPA) [21], for example, has suggested six actions for teachers to deal with IAQ problems in classrooms, such as keeping ventilation units free of clutter and reducing the use of cloth-made items in classrooms. Because teachers usually understand the importance of IEQ in classrooms in relation to children's learning performance, the US EPA emphasized that teachers, as the occupants in classrooms with children, can play an important role in creating a healthy and comfortable indoor environment in classrooms [22]. Nevertheless, not much is known about the actual impact of teachers' actions on school children's perceived comfort.

Another notable point is that traditional school children's IEQ perceptions have been found to be different from children of non-traditional school (those schools adopted an alternative educational system such as the Jena, Montessori, or Dalton system) and one possible explanation might be their different pedagogy [2, 23]. At non-traditional schools, children have more freedom to choose the place to work, they can move freely and have access to all material area [24-26], with this freedom, children might have more possibilities to make themselves feel comfortable in the classrooms. Additionally, the emphasis of these schools is put on every individual child. For example, at Montessori schools, children have the possibility to develop freely and naturally and receive personalized education [27]; at Dalton schools, children study on their own pace and they can also get individual help [28]; at Jena schools the most important purpose is to value the difference among children [29]. Therefore, children feel freer to ask their teachers' help at these schools, and it's not hard to imagine that teachers' actions and the relationship between teachers and

children are different at these schools. However, so far, there has never been a study that compared teachers' actions of traditional schools with non-traditional schools.

Therefore, to get more insights into the impact of teachers' actions, the underlying study aimed to assess and analyse the relations between primary school children's comfort perceptions in classrooms, the frequency of children asking teachers to change the indoor environmental conditions (by actions such as turning on/off lights; lift/lower shades; close/open windows; etc.), and the frequency of the actual teachers' actions to improve IEQ in classrooms. Moreover, to compare these results between traditional schools and non-traditional schools, all the analyses were conducted for these two types of schools separately.

3.2 Methods

3.2.1 Data collection

This study was part of a large field investigation on health and comfort of school children in 54 classrooms of 21 primary school buildings in the Netherlands, conducted in the spring of 2017 [2]. In the field investigation, data were collected through children's questionnaires, teachers' questionnaires, classroom checklists, school building checklists and physical measurements.

General information

The field study involved 1,145 school children and 54 teachers. Out of the 21 primary schools studied, 17 (45 classrooms, 949 children) are traditional schools, and five (9 classrooms, 196 children) are non-traditional schools. The data of one traditional school teacher was excluded from this study because of its low completeness, and correspondingly, the children's data in the same class were also excluded. Therefore, 1128 children, consisting of 568 boys and 560 girls with a mean age of 10 years (9-12), and 53 teachers were the final subjects of this study.

Before the field investigation, parents of the participating children were notified and given a consent form to allow their children's participation. Researchers handed out the questionnaire to every child and teacher in their own classroom and collected the questionnaires when they were finished. The children and the teachers were given the opportunity to skip any question or even withdraw their participation at any time. The complete procedure of the data collection of the large field investigation has been reported by Bluysen et al. [2].

Teachers' questionnaire

The teachers' questionnaire comprised six parts: 1. General questions, including type of board present (blackboard, whiteboard or smartboard) and control of indoor environment; 2. Questions about thermal quality, including frequency of opening/closing windows, turning on/off heaters and turning of/off the ventilator/cooling, and lifting/lowering shades, and frequency of children requesting to open/close windows and turn on/off heaters; 3. Questions about visual quality, including frequency of lifting/lowering shades and turning on/off lights, and frequency of children requesting to lower/lift shades; 4. Questions about IAQ, including frequency of opening windows/doors, and frequency of children requesting to open windows/doors; 5. Questions about acoustical quality, including frequency of opening windows/doors and frequency of children requesting to open windows/doors; and 6. Weekly schedule of children's activities such as lessons and breaks. Only one teacher in each classroom was asked to fill out a questionnaire and it took them approximately 10 minutes.

Children's questionnaire

The children's questionnaire comprised five parts: 1. General questions, such as age, sex, commuting, general feeling and seating position in classroom; 2. Questions on health, including conditions such as asthma, and symptoms such as dry eyes; 3. Questions about the classroom environment, including cleanliness, temperature, draught, smell, noise, visibility and light; 4. Questions on control, including preference of a number of individually controlled devices (ICDs), importance ranking of environmental factors; 5. Questions about their home, including type of house, location, flooring material in bedroom, smoking at home and presence of pets. The questionnaire comprised 37 questions in total, and on average children spent 30 minutes to fill it out. In order to help children understand some of the questions, a few cartoon illustrations were included in the questionnaire. Besides, a short

introduction was given before children filled in the questionnaire, and they could ask the researchers present in case they were confused about a question.

Regarding teachers' questionnaire, frequencies of teachers' actions to improve the IEQ and frequencies of children's requests (See Appendix A) were the main focus of the underlying paper. Concerning children's questionnaire, only the questions about children's perceptions of comfort (See Appendix B) were taken into consideration. The other data, i.e. checklists and physical measurements, have been reported elsewhere [2].

3.2.2 Data analysis

Data were analysed in four steps using SPSS version 23.0 (SPSS Inc. Chicago, IL, USA). First, the basic information (e.g. the mean and standard deviation of school children's comfort perceptions, the frequency of teachers' actions and children's requests) was analysed using descriptive analysis. Both the answers of the school children and the answers of the teachers were analysed at classroom level. It means that the data related to the children's answers were split into 53 groups based on classroom ID and for each classroom the mean values were calculated. Using these classroom-based mean values and teachers' answers, a new database was created. All further analyses performed at classroom level were based on this new database.

Then, relationships among school children's comfort perceptions, their requests and teachers' actions were analysed with t-tests and Chi-squared tests. Previous results [2] showed that children's perceptions of IEQ in classrooms of non-traditional schools differed significantly from perceptions of children of traditional schools. For this reason, in this paper all of the analyses were conducted in three parts: all the schools together, the traditional schools independently, and the non-traditional schools independently.

3.3 Results

3.3.1 Descriptive analysis results

Children's comfort perception (children's questionnaire)

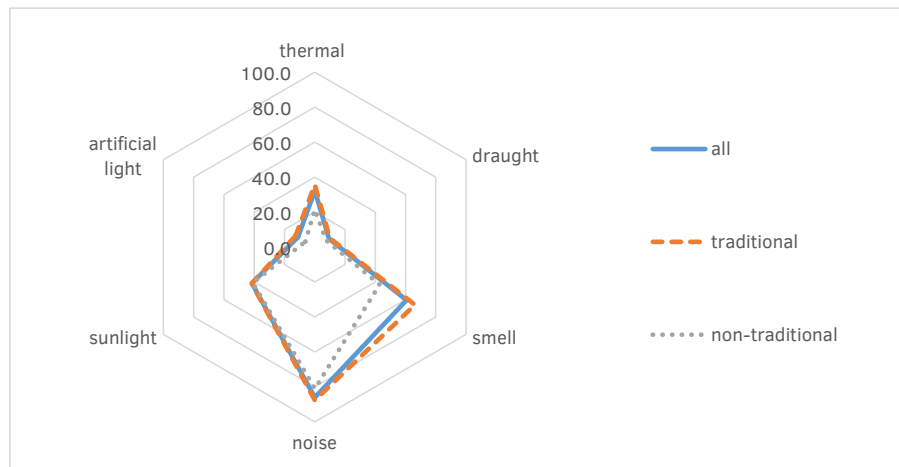

FIG. 3.1 Percentage of school children's discomfort for the different IEQ aspects in their classrooms.

In the field study [2], children's comfort perceptions in classrooms were collected by directly asking them "Can you hear/smell/see...". If they gave an affirmative answer (yes or sometimes), they needed to answer the question: "Are you bothered by the noise/smell/light...?". The affirmative answers to these questions were regarded as discomforts in this study. Figure 3.1 shows the percentage of school children who stated to have these discomforts. In general, as reported by Bluysen et al. [2], children of traditional schools felt less comfortable in classrooms than children of non-traditional schools. 'Noise' caused the most discomfort: on average, 86% of children in classrooms were bothered by noise (88% for traditional schools and 81% for non-traditional schools). And according to their reports, most of the noise was caused by their classmates. 'Smell' was the second most important cause of discomfort: 63% of children were bothered by it (67% for traditional schools

and 44% for non-traditional schools). The third cause of discomfort was sunlight: 42% of children of both types of schools were bothered by it. Followed by ‘Thermal discomfort’: 35% of the children were bothered by it (38% for traditional schools and 21% for non-traditional schools). ‘Artificial light’ and ‘draught’ were perceived as least important causes of discomfort in classrooms.

Teachers’ actions (teachers’ questionnaire)

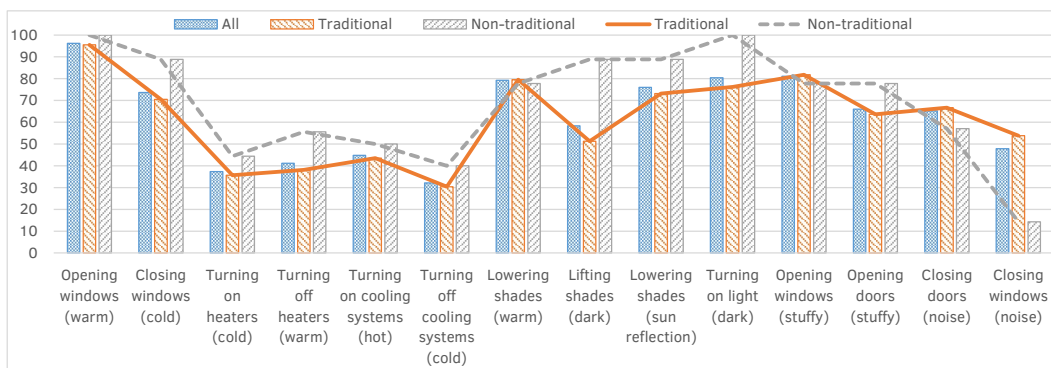

FIG. 3.2 Percentage of teachers who performed these actions at least once a day in the classrooms.

Note: The reasons for the actions are shown in parenthesis.

The main teacher in each of the classrooms was asked to fill out the teachers’ questionnaire. The questions about the frequency of teachers’ actions and school children’s requests to the teachers with respect to these actions were analysed. The related answers like ‘once a day’ and ‘more than once a day’ were combined to ‘at least once a day’; other possible answers were combined to ‘less than once a day’. Figure 3.2 presents the percentage of teachers who performed these actions ‘at least once a day’ in the classrooms of different types of school.

In general, the difference of the frequency of teachers’ actions between these two types of schools were not significant. As it is shown in Table 3.1, among these 14 actions, opening windows because of “too warm” complaints was the most frequent one; more than 90% of teachers at all schools opened windows at least once a day. Closing windows because of “too cold”, complaints, lowering shades because of “too warm” complaints, lowering shades because of “sun reflection” complaints, turning on lights because of “too dark” complaints, and opening windows because of “stiffness” complaints, were also performed often. More than 70% of the teachers

at all schools performed those actions at least once a day. Actions related to cooling systems occurred the least; less than 50% of teachers at all schools adjusted them daily, which might be related to the fact that these systems were not present in some classrooms: only 18 classrooms (14 traditional and 4 non-traditional) has the mechanical balanced system, and not all of the teachers answered those related questions. Therefore, two questions about the cooling system were not included in the following analysis because of the small number of samples.

Besides, it is worth to mention that 100% of non-traditional schools possessed the external shading, while for traditional schools, this percentage was only 67%. Apart from these, the possession rates of all the other related equipment (including operable window, heater, light, and door) were all 100% at both types of schools.

Among these 14 actions, opening windows because of “too warm” complaints was the most frequent one; more than 90% of teachers in all schools opened windows more than once a day. Lowering shades because of “too warm” complaints, turning on lights because of “too dark” complaints, and opening windows because of “stiffness” complaints, were also performed often. Around 80% of the teachers in all schools performed those actions everyday. Actions related to heating and cooling systems occurred the least; less than 50% of teachers in all schools adjusted them daily, which might be related to the fact that these systems were not present in some classrooms: 78% of the classrooms used radiators, 22% of the classrooms used floor heating, and 35% of the classrooms used heated air. As for the ventilation systems, 48% of the classrooms used natural ventilation, 18.5% of the classrooms used mechanical assisted systems, and 33% of the classrooms used mechanical balanced systems.

In general, teachers in the non-traditional schools performed all of these actions more often than teachers in the traditional schools. Only four of these 14 actions (lowering shades because of “too warm” complaints, opening windows because of stuffy air complaints, closing doors because of noise complaints, and closing windows because of noise complaints) were performed more often by teachers of traditional schools. Except for ‘lifting shades because of “too warm” complaints ($P=0.039$), no statistically significant difference of frequency of teachers’ actions between these two types of schools was found (Table 3.1).

TABLE 3.1 Difference of frequency of teachers' actions between different school types.

Actions ¹	Traditional [%] ²	Non-traditional [%]	p ³
Opening windows (warm)	95.5 (42/44)	100.0 (9/9)	1.000
Closing windows (cold)	70.5 (31/44)	88.9 (8/9)	0.416
Turning on heaters (cold)	35.7 (15/42)	44.4 (4/9)	0.711
Turning off heaters (warm)	38.1 (16/42)	55.6 (5/9)	0.460
Turning on cooling/ventilation systems ⁴ (warm)	25.0 (2/8)	0.0 (0/2)	0.784
Turning off cooling/ventilation systems ⁴ (cold)	25.0 (2/8)	0.0 (0/2)	0.692
Lowering shades ⁵ (warm)	78.9 (30/38)	77.8 (7/9)	1.000
Lifting shades ⁵ (dark)	51.4 (19/37)	88.9 (8/9)	0.061
Lowering shades (sun reflection)	74.4 (29/39)	88.9 (8/9)	0.662
Turning on light (dark)	76.2 (32/42)	100.0 (9/9)	0.176
Opening windows (stuffy)	81.8 (36/44)	77.8 (7/9)	1.000
Opening doors (stuffy)	63.6 (28/44)	77.8 (7/9)	0.701
Closing doors (noise)	66.7 (26/39)	57.1 (4/9)	0.681
Closing windows (noise)	53.8 (21/39)	14.3 (1/9)	0.098

Notes: 1. The reasons for the actions are shown in parenthesis; 2. The number of teachers who performed this action and the number of teachers who answered this are were shown in parenthesis; 3. P-values shown were obtained from Fisher's exact test; 4. The possession rate of cooling system is 32% at traditional schools and 44% at non-traditional schools; 5. The possession rate of shades is 67% at traditional schools and 100% at non-traditional schools.

Children's request (teachers' questionnaire)

Figure 3.3 presents the percentage of teachers who were asked by children to perform these adjustments 'at least once a day' in the classrooms of different types of school. 'Adjusting windows' was the most frequent request of children at all schools. More than 70% of the teachers, at both types of schools were asked to perform that action at least once a day because of children's thermal discomfort. 'Adjusting shades' was also a frequent request: 61% of the teachers (51% for traditional schools and 78% for non-traditional schools) were asked to perform this at least once a day because of children's visual discomfort. Compared to these requests, 'Adjusting windows/doors because of smell or noise in the classroom' were the least frequent request, with less than half of the teachers asked to do these adjustments at least once a day at both types of schools.

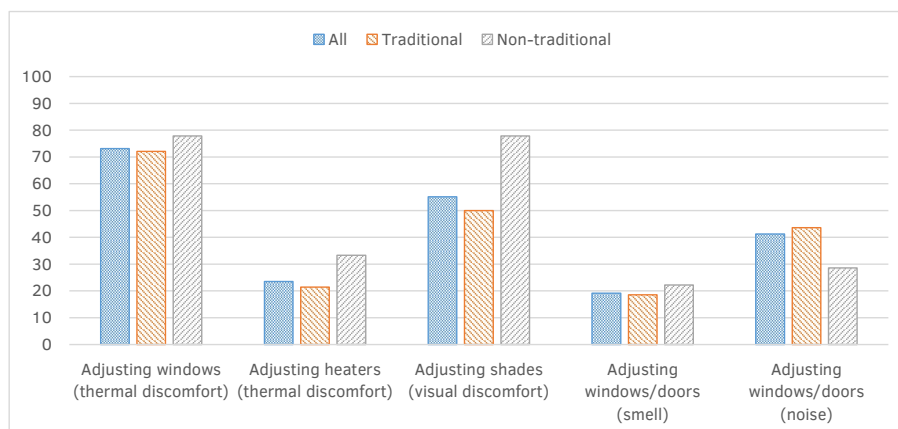

FIG. 3.3 Percentage of teachers, for different types of schools, who were asked by the children to perform these adjustments at least once a day.

Note: The reasons of the requests are shown in parenthesis.

When comparing traditional schools and non-traditional schools, it can be seen that almost all of these requests, except for ‘adjusting windows/doors because of noise’, were asked more frequently in classrooms of non-traditional schools. However, the differences of frequency of children’s requests between these two types of schools were not statistically significant (Table 3.2).

TABLE 3.2 Difference of frequency of children’s requests between different school types.

Children’s requests ¹	Traditional [%] ²	Non-traditional [%]	p ³
Adjusting windows (thermal discomfort)	72.1 (31/43)	77.8 (7/9)	1.000
Adjusting heaters (thermal discomfort)	21.4 (9/42)	33.3 (3/9)	0.424
Adjusting shades ⁴ (visual discomfort)	51.3 (20/39)	77.8 (7/9)	0.364
Adjusting windows/doors (smell)	18.6 (8/43)	22.2 (2/9)	1.000
Adjusting windows/doors (noise)	43.6 (17/39)	28.6 (2/7)	0.682

Notes: 1. The reasons for the actions are shown in parenthesis; 2. The number of teachers who performed this action and the number of teachers who answered this are shown in parenthesis; 3. P-values shown were obtained from Fisher’s exact test; 4. The possession rate of shades is 67% at traditional schools and 100% at non-traditional schools.

3.3.2 Relationship analysis

In almost all the classrooms of the primary schools studied, the teacher was the only one who was able to control the IEQ in the classroom by performing actions such as opening or closing windows, turning lights on or off, etc. If children felt uncomfortable, what they could do was to ask the teacher for help. Therefore, as shown in Figure 3.4, the following hypotheses can be made:

- Children's comfort perceptions have an impact on their requests to teachers.
- Children's requests have an impact on teacher's actions.
- Teacher's actions, in turn, have an impact on children's comfort perception.

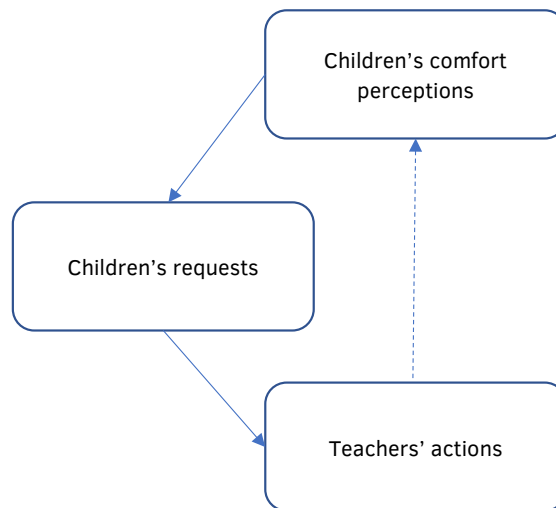

FIG. 3.4 Relationships between children's comfort perceptions, requests and teachers' actions.

To test whether the teacher can help children feel better or not by performing actions based on the children's request, relationships between children's perceptions, children's requests, and teachers' actions were studied.

Relationship between children's comfort perceptions and their requests

A comparison of school children's comfort perceptions was conducted with t-tests between two groups of classrooms with different frequencies of children's requests (less than once a day vs. at least once a day). The results are presented in Table 3.3. In general, the differences found were not significant, except for 'bothered by noise' in the analysis of all schools ($p=0.039$) and in the analysis of the traditional schools ($p=0.031$); and for 'bothered by sunlight' in the analysis of the non-traditional schools ($p=0.041$).

TABLE 3.3 Comparison of children's perceptions between two groups of classrooms with different frequencies of children's requests (less than once a day vs. at least once a day).

Children's perceptions	Children's requests ¹	All ² P _A	Traditional P _T	Non-traditional P _N
Thermal discomfort	Adjusting windows (thermal discomfort)	0.080	0.125	0.094
	Adjusting heaters (thermal discomfort)	0.446	0.324	0.516
Bothered by draught	Adjusting windows/ doors (smell)	0.462	0.605	0.347
Bothered by smell		0.739	0.363	0.313
Bothered by sunlight	Adjusting shades (visual discomfort)	0.407	0.865	0.041
Bothered by artificial light		0.150	0.207	0.896
Bothered by noise	Adjusting windows/ doors (noise)	0.039	0.031	0.460

Notes: 1. The reasons for the requests are shown in parenthesis; 2. P-values are obtained from t-tests. P-values in bold highlighted are the correlations with statistical significance ($p<0.05$).

Detailed information on these three significant relations is shown in Appendix C. Generally, as more children were bothered by noise, more children asked their teachers to adjust windows/doors more often (at least once a day). The same tendency was also found at traditional schools. For the non-traditional schools, as more children were bothered by sunlight, the more children asked the teacher to adjust shades more often (at least once a day).

Relationship between school children's requests and teachers' actions

The relationships between teachers' actions and children's requests were analysed with Chi-squared and Fisher exact tests (with an expected cell size less than 5). As shown in Table 3.4, in the analysis of all schools statistically significant relations

were found for all of the IEQ factors ($p < 0.05$), except for the visual aspect. The more frequently the children asked, the more often the teacher performed the related actions, and this was also found for traditional schools (Appendix D). For non-traditional schools, no statistically relevant relationship between teachers' actions and children's requests was found.

TABLE 3.4 Relationships between children's requests and teachers' actions.

Children's requests	Teachers' actions ¹	All ² P_A	Traditional P_T	Non-traditional P_N
Adjusting windows (thermal discomfort)	Opening windows (warm)	0.069*	0.073	-
	Closing windows (cold)	0.001*	<0.001*	1.000*
	Turning on cooling/ventilation systems (warm)	0.020*	0.089*	0.400*
	Turning off cooling/ventilation systems (cold)	0.026*	0.057*	0.400*
	Lowering shades (warm)	0.429*	0.195*	1.000*
Adjusting heaters (thermal discomfort)	Turning on heaters (cold)	0.038*	0.006*	1.000*
	Turning off heaters (warm)	0.008	0.017*	1.000*
Adjusting windows/ doors (smell)	Opening windows (stuffy air)	0.670*	1.000*	1.000*
	Opening doors (stuffy air)	0.137*	0.226*	1.000*
Adjusting shades (visual discomfort)	Lifting shades (dark)	0.002	0.022	0.222*
	Lowering shades (sun reflection)	<0.001*	<0.001	0.222*
	Turning on lights (dark)	0.028*	0.027	-
Adjusting windows/ doors (noise)	Closing doors (noise)	0.004	0.001	1.000*
	Closing windows (noise)	<0.001	0.002	0.286*

Notes: 1. The reasons for the requests are shown in parenthesis; 2. P-values with* are obtained from Fisher's exact tests, all others are obtained from Chi-squared tests. P-values in bold highlighted are the correlations with statistical significance ($p < 0.05$).

Relationship of teachers' actions and children's comfort perceptions

To identify the differences of children's comfort perceptions between two groups of classrooms with different frequencies of teachers' actions (less than once a day vs. at least once a day), t-tests were conducted. As shown in Table 3.5, almost all the P-values were greater than 0.05: there was no statistically significant difference in children's comfort perceptions between the conditions that teachers performed these actions at least once a day and the conditions that teachers performed these actions less than once a day.

TABLE 3.5 Comparison of children's perceptions between two groups of classrooms with different frequencies of teachers' actions (less than once a day vs. at least once a day).

Children's perceptions	Teachers' actions ¹	All ² P _A	Traditional P _T	Non-traditional P _N
Thermal discomfort	Opening windows (warm)	0.776	0.611	-
	Closing windows (cold)	0.930	0.474	0.072
	Turning on heaters (cold)	0.605	0.387	0.823
	Turning off heaters (warm)	0.652	0.374	0.988
	Turning on cooling/ ventilation systems (warm)	0.167	0.132	0.389
	Turning off cooling/ventilation systems (cold)	0.524	0.597	0.081
	Lowering shades (warm)	0.238	0.713	0.010
Bothered by draught	Opening windows (stuffy air)	0.938	0.699	0.386
	Opening doors (stuffy air)	0.668	0.586	0.386
Bothered by smell	Opening windows (stuffy air)	0.341	0.933	0.097
	Opening doors (stuffy air)	0.827	0.564	0.097
Bothered by sunlight	Lifting shades (warm)	0.844	0.932	0.510
	Lowering shades (dark)	0.985	0.854	0.510
	Lowering shades (sun reflection)	0.989	0.874	-
Bothered by artificial light	Raising shades (dark)	0.181	0.333	0.640
	Lowering shades (sun reflection)	0.692	0.805	0.640
	Turning on lights (dark)	0.566	0.841	-
Bothered by noise	Closing door (noise)	0.007	0.002	0.232
	Closing windows (noise)	0.010	0.014	0.056

Notes: 1. The reasons for the requests are shown in parenthesis; 2. P-values are obtained from t-tests. P-values in bold highlighted are the correlations with statistical significance ($p < 0.05$).

However, some statistically relevant differences of children's perceptions were found between different frequency of teachers' actions. For all schools, the frequency of teachers' closing doors or windows was higher (at least once a day) in the classrooms with higher percentage of children bothered by noise. The tendency is the same for the classrooms of traditional schools. For the non-traditional schools, a statistically relevant difference was found for the thermal comfort aspect. The more children felt thermally uncomfortable in the classrooms, the higher frequency of teachers lowering shades (at least once a day). More details about these differences can be found in Appendix E.

3.4 Discussion

3.4.1 Difference between traditional schools and non-traditional schools

Different results between traditional schools and non-traditional schools can be found in Tables 3.3 - 3.5. The relationships between children's perceptions, children's requests, and teachers' actions only exist at traditional schools, and only for the acoustical aspect (Figure 3.5a). Children's poor noise perceptions resulted in more requests of adjusting windows/doors, and these increasing number of requests led teachers to more frequently open or close windows/doors. Further, the frequency of teachers' opening/closing windows/doors was proved to relate to children's noise perceptions. For other aspects of IEQ at traditional school, relationships were only found between children's requests and teachers' actions (Table 3.4 & Figure 3.5a). Thereby, these results indicate that although teachers did take actions at the request of children, these actions did not really improve children's comfort perception, because children's requests were not related to their comfort perceptions.

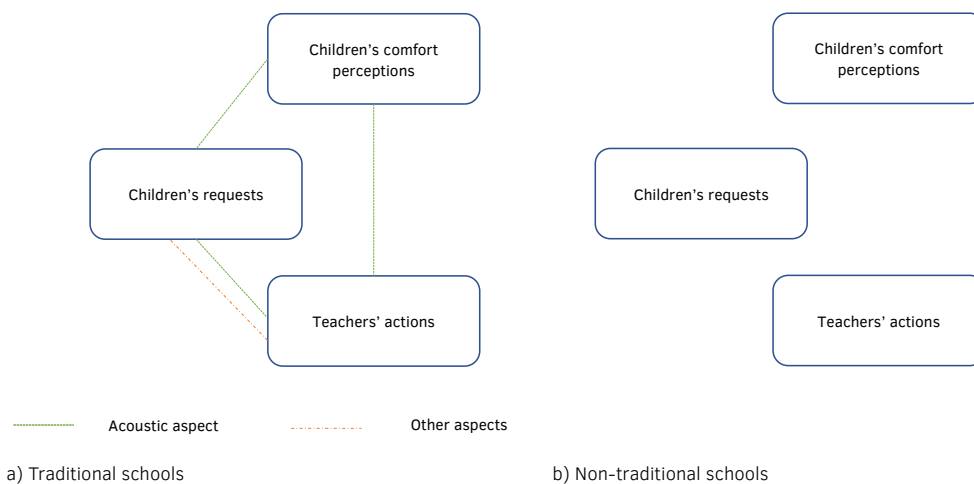

FIG. 3.5 Relationships between children's comfort perceptions, requests and teachers' actions at different schools.

There are two hypothesized reasons for the irrelative relations between children's requests and perceptions. It could be that teachers can only respond to one request at one moment, or it also could be that some children do not ask teachers' help even though they felt uncomfortable (some children are timid or some children just do not think teachers could help them). Concerning the disconnection between children's perceptions and teachers' actions, there are also two possible reasons. The first one is similar as the one mentioned before: teachers can only take one action to response to one child at one moment. The second one might be due to the limited options that teachers can do (on/off heaters; lift/lower shades; open/close windows) to change or control the IEQ in classrooms.

In terms of the non-traditional schools, the relationship circle could not be established among these three items (Figure 3.5b), and almost no single relationship was found between any two of them for all the aspects of IEQ, except two: one is between children's sunlight perceptions and their requests of adjusting shades (Table 3.3), and the other one is between children's thermal perceptions and the frequency of teachers' lowering shades (Table 3.5).

The disconnection among children's perceptions, children's requests and teachers' actions at non-traditional schools might be explained by their special pedagogy that children have much more freedom at these schools, and some of them even have individualized lessons [27]. In this context, children could ask more requests, but unfortunately, the more requests that children asked, the harder for teachers to receive them all and not to mention to response, especially when the requests were conflicting.

In fact, as a previous study showed, different children have different perceptions, and therefore different requests, in the same classroom because of their different personalities, and these children can be classified into six clusters based on their needs and perceptions of IEQ in classrooms [30]. This makes it difficult for teachers to take actions to make all children feel better. Although the non-traditional schools were not included in the previous study because of the limited data amount, it is not hard to deduce that children at non-traditional schools are also different from each other and their teachers are also not able to respond to their different requests at the same time. Therefore, it seems that no matter at which type of schools, teachers could not fulfil children's requests, because a request of one type of children could cause discomfort to another one.

3.4.2 Limitations and suggestions for future research

Although this study provides important insights into the relationships among children's comfort perceptions, their requests, and teachers' actions in the classrooms, the small age span of children could be a limitation. All the children that participated in this survey were between 9 to 12 years old. Thus, the results of this study cannot be generalised to all primary school children. Future research could possibly extend the study sample by taking younger children into account and more children of non-traditional schools. In addition, especially when younger children are involved, the data collection method (questionnaire survey) used in this study can be a limitation as well. Future research could apply other types of data collection methods, for example observations or interviews.

3.5 Conclusion

This study aimed to find out relationships between school children's comfort perceptions, their requests, and teachers' actions in their classrooms at traditional and non-traditional schools. For traditional schools, this study showed that even though most children felt uncomfortable with "noise" and "smell", the children cannot do a lot to change these conditions, except for asking for their teachers' help. With regard to acoustics, the significant relations between children's perceptions, their requests and teachers' actions indicated the positive relationship between children and teachers. Children could express their annoyance of noise by asking teachers' help and teachers could take actions at their requests. However, even so, noise is still the most annoying problem in classrooms. Regarding to the other factors of IEQ, although teachers' actions were proved to be related to children's requests, neither of them were found to be related to children's perception. In other words, teachers' actions could not really help these children since these requests were not stem from children's perception.

For non-traditional schools, this study could hardly establish the relationship between children' perception, their request and teachers' actions. One possible reason of this weak interaction could be that the special pedagogy applied in these schools ensure more freedom and right to children, so, they can easily change position or even adjust the IEQ by themselves. However, even in the relaxed learning environment, children still felt uncomfortable in terms of the IEQ in classrooms.

Therefore, to sum up, more effective methods seem worth investigating no matter at which type of schools. Knowing that different children have different preferences and needs, one teacher could not fulfil all of them at once, it is likely that different solutions are required. Since oneself is the expert of their own perception, everyone should have the right to change their local IEQ. Thus, a possible option in the future could be providing children with individually controlled devices as is already being used in the office environment.

References

- [1] Stranger, M., S. Potgieter-Vermaak, and R. Van Grieken, Comparative overview of indoor air quality in Antwerp, Belgium. *Environment International*, 2007. 33(6): p. 789-797.
- [2] Bluysen, P.M., D. Zhang, S. Kurvers, M. Overtoom, and M. Ortiz-Sanchez, Self-reported health and comfort of school children in 54 classrooms of 21 Dutch school buildings. *Building and Environment*, 2018. 138: p. 106-123.
- [3] Theodosiou, T. and K. Ordoumpozanis, Energy, comfort and indoor air quality in nursery and elementary school buildings in the cold climatic zone of Greece. *Energy and Buildings*, 2008. 40(12): p. 2207-2214.
- [4] Turunen, M., O. Toyinbo, T. Putus, A. Nevalainen, R. Shaughnessy, and U. Haverinen-Shaughnessy, Indoor environmental quality in school buildings, and the health and wellbeing of students. *International journal of hygiene and environmental health*, 2014. 217(7): p. 733-739.
- [5] Mendell, M.J., E.A. Eliseeva, M.M. Davies, M. Spears, A. Lobscheid, W.J. Fisk, and M.G. Apte, Association of classroom ventilation with reduced illness absence: a prospective study in California elementary schools. *Indoor air*, 2013. 23(6): p. 515-528.
- [6] Daisey, J.M., W.J. Angell, and M.G. Apte, Indoor air quality, ventilation and health symptoms in schools: an analysis of existing information. *Indoor air*, 2003. 13(1): p. 53-64.
- [7] Haverinen-Shaughnessy, U., A. Borrás-Santos, M. Turunen, J.P. Zock, J. Jacobs, E. Krop, L. Casas, R. Shaughnessy, M. Täubel, and D. Heederik, Occurrence of moisture problems in schools in three countries from different climatic regions of Europe based on questionnaires and building inspections—the HITEA study. *Indoor Air*, 2012. 22(6): p. 457-466.
- [8] Chatzidiakou, L., D. Mumovic, and A.J. Summerfield, What do we know about indoor air quality in school classrooms? A critical review of the literature. *Intelligent Buildings International*, 2012. 4(4): p. 228-259.
- [9] Mendell, M.J. and G.A. Heath, Do indoor pollutants and thermal conditions in schools influence student performance? A critical review of the literature. *Indoor Air*, 2005. 15(1): p. 27-52.
- [10] Bakó-Biró, Z., D. Clements-Croome, N. Kochhar, H. Awbi, and M. Williams, Ventilation rates in schools and pupils' performance. *Building and Environment*, 2012. 48: p. 215-223.
- [11] Wong, N.H. and S.S. Khoo, Thermal comfort in classrooms in the tropics. *Energy and buildings*, 2003. 35(4): p. 337-351.
- [12] ter Mors, S., J.L. Hensen, M.G. Loomans, and A.C. Boerstra, Adaptive thermal comfort in primary school classrooms: Creating and validating PMV-based comfort charts. *Building and Environment*, 2011. 46(12): p. 2454-2461.
- [13] Shield, B.M. and J.E. Dockrell, Acoustical barriers in classrooms: the impact of noise on performance in the classroom. *British Educational Research Journal*, 2006. 32: p. 17.
- [14] Shield, B.M. and J.E. Dockrell, The effects of noise on children at school: a review. *Building Acoustics*, 2003. 10(2): p. 97-116.
- [15] Klätte, M., J. Hellbrück, J. Seidel, and P. Leistner, Effects of classroom acoustics on performance and well-being in elementary school children: A field study. *Environment and Behavior*, 2010. 42(5): p. 659-692.
- [16] Wu, W. and E. Ng, A review of the development of daylighting in schools. *Lighting Research and Technology*, 2003. 35(2): p. 111-124.

- [17] Hathaway, W.E., Effects of school lighting on physical development and school performance. *The Journal of Educational Research*, 1995. 88(4): p. 228-242.
- [18] Bluysen, P.M., Health, comfort and performance of children in classrooms—new directions for research. *Indoor and Built Environment*, 2017. 26(8): p. 1040-1050.
- [19] Zhang, D., M.A. Ortiz, and P.M. Bluysen, Clustering of Dutch school children based on their preferences and needs of the IEQ in classrooms. *Building and Environment*, 2019. 174: p. 258-266.
- [20] UNESCO. School HVAC: High Performance School Characteristics. 2014 [cited 2018 10 July]; Available from: <http://www.unescocorp.com/sedial-eiusmod-tempor/>.
- [21] United States Environmental Protection Agency. Top Actions Teachers Can Take to Address IAQ. 2016 [cited 2018 10 July]; Available from: https://19january2017snapshot.epa.gov/iaq-schools/teachers-and-healthy-indoor-school-environments_.html#topactions.
- [22] United States Environmental Protection Agency. Teachers and Healthy Indoor School Environments. 2016 [cited 2018 10 July]; Available from: <https://www.epa.gov/iaq-schools/teachers-and-healthy-indoor-school-environments>.
- [23] Rathunde, K. and M. Csikszentmihalyi, Middle school students' motivation and quality of experience: A comparison of Montessori and traditional school environments. *American journal of education*, 2005. 111(3): p. 341-371.
- [24] Dik Trom. School for strong Dalton education [cited 2019; Available from: <https://obsdiktrom.nl/wp-content/uploads/Schoolguide-English-version.pdf>].
- [25] MONTESSORI NORTHWEST. Inside a Montessori Classroom. 2017 [cited 2019; Available from: <https://montessori-nw.org/inside-a-montessori-classroom>].
- [26] CHAN, K.W.P., Innovative learning environments (ILE): Inventory case study: Lok Sin Tong Leung Wong Wai Fong Memorial School, Hong Kong. 2012.
- [27] Lillard, A.S., Playful learning and Montessori education. *NAMTA Journal*, 2013. 38(2): p. 137-174.
- [28] Koski, M.-I. Dutch primary education: Montessori & The Dalton Plan. 2014 26 Aug; Available from: <https://www.iamexpat.nl/education/education-news/dutch-primary-education-montessori-dalton-plan>.
- [29] Koski, M.-I., Dutch primary education: Jenaplan & Steiner. 2014 26 Aug; Available from: <https://www.iamexpat.nl/education/education-news/dutch-primary-education-jenaplan-steiner>.
- [30] Zhang, D., M.A. Ortiz, and P.M. Bluysen, Clustering of Dutch school children based on their preferences and needs of the IEQ in classrooms. *Building and environment*, 2019. 147: p. 258-266.

Appendix 3.A / Teachers' questionnaire

School number: _____ Group: _____
Teacher's name: _____ Date: _____

Dear Teacher,

This questionnaire is intended to understand the actions you perform in your classroom to improve the indoor climate.

The questions deal with your actions and whether your pupils also ask you to change the indoor environment when they feel discomfort.

If something is not clear, you can of course always ask us.

Thanks in advance for your cooperation!

1- General questions

1.1- Is there a blackboard or a digiboard present?

- Digiboard
- Blackboard
- Both

1.2- I am allowed (by building management) to make changes to the indoor climate of the classroom (think of the thermostat, opening windows, ventilation, etc.)

- Yes, I am allowed
- No, I am not allowed

1.3- Where I teach I would prefer:

- Free manual control (opening/closing windows and shades, manual heating and cooling set points)
- Automatic control (mechanical ventilation, automatic shading and heating and cooling set points)

2- Thermal quality actions

Indicate how often you do the following things to adjust thermal quality:

	Less than 1x per week	1x per week	Less than 1x per day	1x per day	More than 1x per day
Opening windows when it is warm or when the children ask	<input type="radio"/>	<input type="radio"/>	<input type="radio"/>	<input type="radio"/>	<input type="radio"/>
Closing windows when it is cold or when the children ask	<input type="radio"/>	<input type="radio"/>	<input type="radio"/>	<input type="radio"/>	<input type="radio"/>
Turning on the heating when it feels cold or when the children ask	<input type="radio"/>	<input type="radio"/>	<input type="radio"/>	<input type="radio"/>	<input type="radio"/>
Switching off the heating when it is hot or when the students request it	<input type="radio"/>	<input type="radio"/>	<input type="radio"/>	<input type="radio"/>	<input type="radio"/>
Turning on the ventilation/cooling when it is hot or when the children ask	<input type="radio"/>	<input type="radio"/>	<input type="radio"/>	<input type="radio"/>	<input type="radio"/>
Switch off the ventilation/cooling when it is cold or when the children ask	<input type="radio"/>	<input type="radio"/>	<input type="radio"/>	<input type="radio"/>	<input type="radio"/>
Lowering the shades when it is warm or when the children ask	<input type="radio"/>	<input type="radio"/>	<input type="radio"/>	<input type="radio"/>	<input type="radio"/>

Indicate how often the children ask you to do the following actions:

	Less than 1x per week	1x per week	Less than 1x per day	1x per day	More than 1x per day
Children ask me to open/close the windows when they feel too hot/cold	<input type="radio"/>	<input type="radio"/>	<input type="radio"/>	<input type="radio"/>	<input type="radio"/>
Children ask me to switch the heating on/off	<input type="radio"/>	<input type="radio"/>	<input type="radio"/>	<input type="radio"/>	<input type="radio"/>

3- Light and visual quality actions

Indicate how often you do the following things to adjust visual quality:

	Less than 1x per week	1x per week	Less than 1x per day	1x per day	More than 1x per day
Lifting shades when it is dark or when the children ask	<input type="radio"/>	<input type="radio"/>	<input type="radio"/>	<input type="radio"/>	<input type="radio"/>
Lowering shades to reduce reflection or when the children ask	<input type="radio"/>	<input type="radio"/>	<input type="radio"/>	<input type="radio"/>	<input type="radio"/>
Turning on lights when it is dark or when the children ask	<input type="radio"/>	<input type="radio"/>	<input type="radio"/>	<input type="radio"/>	<input type="radio"/>

Indicate how often the children ask you to do the following actions:

	Less than 1x per week	1x per week	Less than 1x per day	1x per day	More than 1x per day
Children ask me to lower/lift shades	<input type="radio"/>	<input type="radio"/>	<input type="radio"/>	<input type="radio"/>	<input type="radio"/>

4- Indoor air quality actions

Indicate how often you do the following things to adjust indoor air quality:

	Less than 1x per week	1x per week	Less than 1x per day	1x per day	More than 1x per day
Opening windows when it is stale, or when the children believe it is stuffy	<input type="radio"/>	<input type="radio"/>	<input type="radio"/>	<input type="radio"/>	<input type="radio"/>
Opening doors when it is stale, or when the children believe it is stuffy	<input type="radio"/>	<input type="radio"/>	<input type="radio"/>	<input type="radio"/>	<input type="radio"/>

Indicate how often the children ask you to do the following actions:

	Less than 1x per week	1x per week	Less than 1x per day	1x per day	More than 1x per day
Children ask me to open windows/doors when it smells bad	<input type="radio"/>	<input type="radio"/>	<input type="radio"/>	<input type="radio"/>	<input type="radio"/>

4.1 The main reason for improving the quality of indoor air is:

- Stuffy air
- Bad smells
- Others: _____

5- Aoustical quality actions

Indicate how often you do the following things to control noise coming from outside:

	Less than 1x per week	1x per week	Less than 1x per day	1x per day	More than 1x per day
Closing doors when it is noisy, or when the children are bothered by it	<input type="radio"/>	<input type="radio"/>	<input type="radio"/>	<input type="radio"/>	<input type="radio"/>
Closing windows when it is noisy, or when the children are bothered by it	<input type="radio"/>	<input type="radio"/>	<input type="radio"/>	<input type="radio"/>	<input type="radio"/>

Indicate how often students ask you for the following thing:

	Less than 1x per week	1x per week	Less than 1x per day	1x per day	More than 1x per day
Students ask me to open windows/doors when it is noisy	<input type="radio"/>	<input type="radio"/>	<input type="radio"/>	<input type="radio"/>	<input type="radio"/>

6- Weekly schedule

The weather today:    

Monday, Tuesday, Thursday, Friday

Class time	Type of lesson	Children in the classroom	
		Number:	
Lesson	from _____ to _____	<input type="radio"/> yes	<input type="radio"/> no
Break	from _____ to _____	<input type="radio"/> yes	<input type="radio"/> no
Lesson	from _____ to _____	<input type="radio"/> yes	<input type="radio"/> no
Lunch	from _____ to _____	<input type="radio"/> yes	<input type="radio"/> no
Lesson	from _____ to _____	<input type="radio"/> yes	<input type="radio"/> no

Wednesday

Class time	Type of lesson	Children in the classroom	
		Number:	
Lesson	from _____ to _____	<input type="radio"/> yes	<input type="radio"/> no
Break	from _____ to _____	<input type="radio"/> yes	<input type="radio"/> no
Lesson	from _____ to _____	<input type="radio"/> yes	<input type="radio"/> no

Describe as far as possible how you control shades, ventilation, temperature etc. in the classroom:

Appendix 3.B / Part of the children's questionnaire

Part 3: Questions about your classroom

13- How do you feel now?

- I'm very cold I'm cold I'm fine I'm warm I'm hot



15- Do you feel draught at the place you are sitting (in the classroom)?

- Every day Sometimes Never (go to question 17)



16- Do you like the draught in your classroom?

- Yes Sometimes No

17- How often do you smell an odour in your classroom?

- Every day Sometimes Never (go to question 19)



18- Are you bothered by that odour in your classroom?

- Yes Often Sometimes No

20- How often do you hear sounds in your classroom?

- Every day Sometimes Never (go to question 23)



21- Are you bothered by the sounds in your classroom?

- Yes Often Sometimes No (go to question 23)

29- Are you bothered by the sunlight?

- Yes Usually Usually not No

Why: _____



30- Are you bothered by the lights when they are on in your classroom?

- Yes Usually Usually not No

Appendix 3.C

Children's comfort perceptions in classrooms with different frequency of children's requests.

Percentage of children bothered by noise in classrooms with children asking the teacher to adjust windows/doors less than once a day and at least once a day (all schools).

	Children ask the teacher to adjust windows/doors	N	Mean (%)	S.D.
Bothered by noise	less than once a day	27	84.03	10.41
	at least once a day	19	89.91	7.23

Percentage of children bothered by noise in classrooms with children asking the teacher to adjust windows/doors less than once a day and at least once a day in traditional schools.

	Children ask the teacher to adjust window/doors	N	Mean (%)	S.D.
Bothered by noise	less than once a day	22	84.83	11.26
	at least once a day	17	91.47	5.35

Percentage of children bothered by sunlight in classrooms with children asking the teacher to adjust shades less than once a day and at least once a day in non-traditional schools.

	Children ask the teacher to adjust shades	N	Mean (%)	S.D.
Bothered by sunlight	less than once a day	2	23.00	11.31
	at least once a day	7	46.31	11.70

Appendix 3.D

Analysis of the relationship between children's requests and teachers' actions.

In all schools.				
		Teacher close windows (cold)		
		less than once a day	at least once a day	total
Children ask to adjust windows (thermal discomfort)	less than once a day	64.3%	35.7%	100.0%
	at least once a day	13.2%	86.8%	100.0%
Total		26.9%	73.1%	100.0%
		Teacher turn on the cooling/ventilation systems (warm)		
		less than once a day	at least once a day	total
Children ask to adjust windows (thermal discomfort)	less than once a day	88.9%	11.1%	100.0%
	at least once a day	40.0%	60.0%	100.0%
Total		55.2%	44.8%	100.0%
		Teacher turn off the cooling/ventilation systems (cold)		
		less than once a day	at least once a day	total
Children ask to adjust windows (thermal discomfort)	less than once a day	100.0%	0.0%	100.0%
	at least once a day	52.6%	47.4%	100.0%
Total		67.9%	32.1%	100.0%
		Teacher turn on heaters (cold)		
		less than once a day	at least once a day	total
Children ask to adjust heaters (thermal discomfort)	less than once a day	71.1%	28.9%	100.0%
	at least once a day	33.3%	66.7%	100.0%
Total		62.0%	38.0%	100.0%
		Teacher turn off heaters (warm)		
		less than once a day	at least once a day	total
Children ask to adjust heaters (thermal discomfort)	less than once a day	68.4%	31.6%	100.0%
	at least once a day	25.0%	75.0%	100.0%
Total		58.0%	42.0%	100.0%
		Teacher lift shades (darkness)		
		less than once a day	at least once a day	total
Children ask to adjust shades (visual discomfort)	less than once a day	63.6%	36.4%	100.0%
	at least once a day	20.0%	80.0%	100.0%
Total		40.4%	59.6%	100.0%

>>>

In all schools.

		Teacher lower shades (sun reflection)		
		less than once a day	at least once a day	total
Children ask to adjust shades (visual discomfort)	less than once a day	50.0%	50.0%	100.0%
	at least once a day	0.0%	100.0%	100.0%
Total		22.4%	77.6%	100.0%
		Teacher turn on lights (darkness)		
		less than once a day	at least once a day	total
Children ask to adjust shades (visual discomfort)	less than once a day	38.1%	61.9%	100.0%
	at least once a day	7.7%	92.3%	100.0%
Total		21.3%	78.7%	100.0%
		Teacher close doors (noise)		
		less than once a day	at least once a day	total
Children ask to adjust windows/doors (noise)	less than once a day	51.9%	48.1%	100.0%
	at least once a day	10.5%	89.5%	100.0%
Total		34.8%	65.2%	100.0%
		Teacher close windows (noise)		
		less than once a day	at least once a day	total
Children ask to adjust windows/doors (noise)	less than once a day	74.1%	25.9%	100.0%
	at least once a day	21.1%	78.9%	100.0%
Total		52.2%	47.8%	100.0%

In traditional schools.

		Teacher close windows (cold)		
		less than once a day	at least once a day	Total
Children ask to adjust windows (thermal discomfort)	less than once a day	75.0%	25.0%	100.0%
	at least once a day	12.9%	87.1%	100.0%
Total		30.2%	69.8%	100.0%
		Teacher turn on heaters (cold)		
		less than once a day	at least once a day	total
Children ask to adjust heaters (thermal discomfort)	less than once a day	75.0%	25.0%	100.0%
	at least once a day	22.2%	77.8%	100.0%
Total		63.4%	36.6%	100.0%

>>>

In traditional schools.

		Teacher turn off heaters		
		less than once a day	at least once a day	total
Children ask to adjust heaters (thermal discomfort)	less than once a day	71.9%	28.1%	100.0%
	at least once a day	22.2%	77.8%	100.0%
Total		61.0%	39.0%	100.0%
		Teacher lift shades (darkness)		
		less than once a day	at least once a day	total
Children ask to adjust shades (visual discomfort)	less than once a day	65.0%	35.0%	100.0%
	at least once a day	27.8%	72.2%	100.0%
Total		47.4%	52.6%	100.0%
		Teacher lower shades (sun reflection)		
		less than once a day	at least once a day	total
Children ask to adjust shades (visual discomfort)	less than once a day	50.0%	50.0%	100.0%
	at least once a day	0.0%	100.0%	100.0%
Total		25.0%	75.0%	100.0%
		Teacher turn on lights (darkness)		
		less than once a day	at least once a day	total
Children ask to adjust shades (visual discomfort)	less than once a day	42.1%	57.9%	100.0%
	at least once a day	10.5%	89.5%	100.0%
Total		26.3%	73.7%	100.0%
		Teacher close doors (noise)		
		less than once a day	at least once a day	total
Children ask to adjust windows/doors (noise)	less than once a day	54.5%	45.5%	100.0%
	at least once a day	5.9%	94.1%	100.0%
Total		33.3%	66.7%	100.0%
		Teacher close windows (noise)		
		less than once a day	at least once a day	total
Children ask to adjust windows/doors (noise)	less than once a day	68.2%	31.8%	100.0%
	at least once a day	17.6%	82.4%	100.0%
Total		46.2%	53.8%	100.0%

Note: The reasons of the requests are shown in parenthesis.

Appendix 3.E

Children's comfort perceptions in classrooms with different frequency of teachers' actions.

Percentage of children bothered by noise in classrooms with the teacher closing the door less than once a day and at least once a day in all schools.

	Teacher close doors (noise)	N	Mean (%)	S.D.
Bothered by noise	less than once a day	16	81.39	10.60
	at least once a day	30	89.16	7.94

Percentage of children bothered by noise in classrooms with the teacher closing windows less than once a day and at least once a day in all schools.

	Teacher close windows (noise)	N	Mean (%)	S.D.
Bothered by noise	less than once a day	24	83.03	10.15
	at least once a day	22	90.20	7.51

Percentage of children bothered by noise in classrooms with the teacher closing the door less than once a day and at least once a day in traditional schools.

	Teacher close doors (noise)	N	Mean (%)	S.D.
Bothered by noise	less than once a day	13	81.13	11.80
	at least once a day	26	91.02	6.41

Percentage of children bothered by noise in classrooms with the teacher closing windows less than once a day and at least once a day in traditional schools.

	Teacher close windows (noise)	N	Mean (%)	S.D.
Bothered by noise	less than once a day	18	83.72	11.51
	at least once a day	21	91.16	6.15

Percentage of children bothered by noise in classrooms with the teacher lowering shades less than once a day and at least once a day in non-traditional schools.

	Teacher lower shades (warm)	N	Mean (%)	S.D.
Thermal discomfort	less than once a day	2	40.35	5.16
	at least once a day	7	15.26	9.49

Note: The reasons of the requests are shown in brackets.

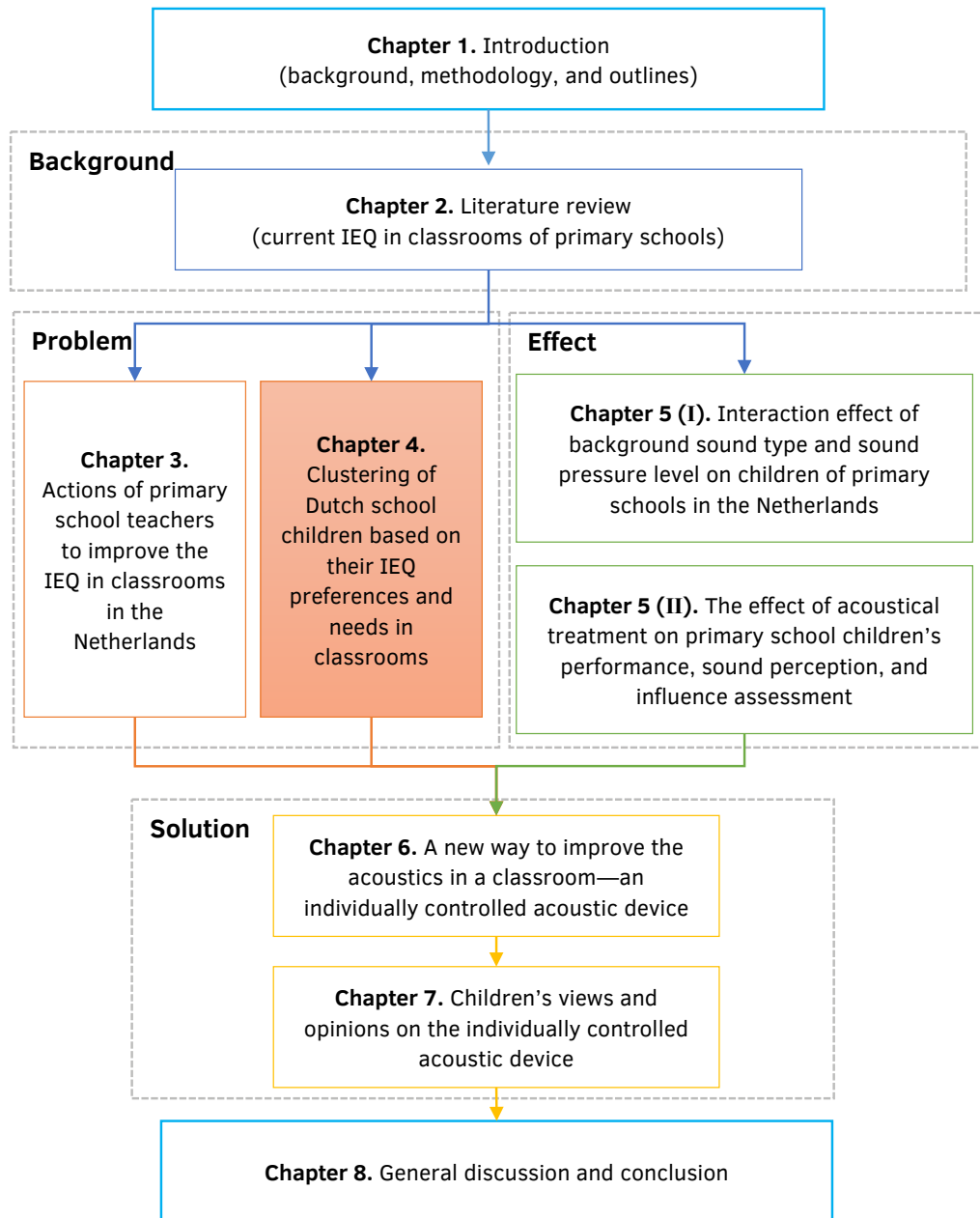

4 Clustering of Dutch school children based on their preferences and needs of the IEQ in classrooms

Teachers' current attempts to improve the IEQ in classrooms were proved, in the previous chapter, to be not effective enough to make children feel satisfied. To find a better way to improve both the IEQ in classrooms and children's satisfaction, one should first ascertain children's preferences and needs. Unfortunately, this information is still insufficient. Therefore, this chapter introduces a field study to identify different children's preferences and needs in terms of the IEQ in classrooms, and then classifies these children into different clusters based on these findings. This paves the way for future studies to figure out the most effective ways to create a more productive learning environment.

This chapter has been published as follows: Zhang, D., Ortiz, M. A., & Bluysen, P. M. (2019). Clustering of Dutch school children based on their preferences and needs of the IEQ in classrooms. *Building and Environment*, 147, 258-266. The layout has been adjusted to fit the style of this thesis.

ABSTRACT

Background: It is well-known that indoor environmental quality (IEQ) in classrooms can have an effect on school children's comfort, health and performance.

Unfortunately, information about the school children's perception of IEQ factors in their classrooms is still insufficient. The objective of this study was to better understand school children's IEQ preferences and needs in classrooms.

Methods: Perceptions, preferences, and needs regarding the IEQ in classrooms were collected by a questionnaire from 1145 school children (9 to 12 years) in 21 primary schools (54 classrooms) in the Netherlands. Descriptive analysis, correlation analysis, principal component analysis and two-step cluster analysis were used to analyse the data.

Results: Using two-step cluster analysis, this study identified six clusters (profiles) of children based on their comfort perceptions and the importance of environmental factors. Among them, four clusters of children had specific concerns related to the IEQ factors: the 'Sound concerned cluster', the 'Smell and Sound concerned cluster', the 'Thermal and Draught concerned cluster', and the 'Light concerned cluster'. However, the other two clusters of children did not show a specific concern, the 'All concerned cluster' was concerned about all IEQ factors in the classroom, while the 'Nothing concerned cluster' did not show any concern.

Conclusion: This study allows for a better understanding of the preferences and needs of primary school children from their own perspective and provides a foundation for future studies to improve both the IEQ in classrooms and school children's comfort and health.

KEYWORDS

School children's perspective; Perception; Questionnaire; Indoor Environmental Quality; Two-step cluster analysis

4.1 Introduction

Indoor environmental quality (IEQ), which includes indoor air quality, acoustical quality, visual quality, and thermal quality, affects occupants' comfort, health, and performance. These influences might be more obvious in classrooms, because children are more sensitive to environmental conditions than adults, especially to environmental pollutants and acoustics [1]. As a result, IEQ in classrooms and its impact on school children has attracted much attention in the last decades. Many studies have shown the influence of indoor air quality (IAQ) [2, 3], thermal comfort [4], light [5], and noise [6] on children at school, and these studies were performed in many countries around the world, for example in Italy [7], in Finland [8], in the US

[9], in China [10], in Australia [11], in Turkey [12] and in Malaysia [13]. However, most of these studies just concerned one or two of the four factors of IEQ, problems concerning all factors of IEQ in classrooms have hardly been addressed [14].

Additionally, as part of a large field study that was conducted in 54 classrooms of 21 primary schools in the Netherlands [15], it was found that teachers cannot fulfil every child's needs related to the IEQ in the classroom [16]. It was concluded there are two reasons for this: 1) each child has different needs; the teacher present cannot respond to each of these needs and 2) even if the teacher was able, there would not be enough available options in a classroom for the teacher to change or adapt the environment.

To create an efficient learning environment, many studies have been conducted to find effective solutions to improve the IEQ of classrooms. However, most of these solutions have been developed based on objective measurements [17] or simulations [12, 18] of IEQ factors in classrooms in relation to criteria set-up for adults, or were focused on financial gains [19]. Although school children were the target group in such studies, it seems that a classroom is nevertheless designed for adults. Fortunately, there are still several studies in which children were involved. For example, a study conducted in two schools in Malaysia showed that children were dissatisfied with the level of noise and air movement [13]. And in a study conducted by Valeski and Stipek, it was found that the way school children feel about their school has an impact on their academic performance [20]. Almost all of these studies assessed children's perceptions or feelings, however none of them did further research into children's needs and preferences of the IEQ in their classrooms.

Despite this research gap, it is worth mentioning that the similar studies about the needs and preferences of adults have been carried out in the office environment. Based on the results of these studies, several so-called Individually Controlled Devices (ICDs) have been designed and developed. These ICDs are meant to provide individual or personal control of the local environment, and can be divided into four types corresponding to the four factors of IEQ:

- Heated or cooled chairs [21, 22] and heating radiant panels [23].
- Personal ventilation [24, 25] and local air vents [25].
- Task-ambient light [26, 27].
- Headphones [28] and sound masking [29].

For improving IEQ, some European guidelines suggest that individual control of the micro-environment of each occupant is required [30], and therefore makes the use of ICDs an interesting topic of research. However, although the aforementioned

ICDs have shown to be beneficial for some office workers, research on children's preferences of the different IEQ factors is insufficient to conclude whether these particular ICDs could be useful for school children as well.

The objective of this study was therefore firstly: to identify the needs of children for the four IEQ factors in classrooms and their preferences for a selection of ICDs, because collecting every child's needs and preferences for IEQ in classrooms and to design specific solutions for each child is too meticulous. The second objective was: to investigate whether it is possible to cluster the school children based on their comfort perceptions and importance of environmental factors, as is often used in market research to segment customers according to their needs and preferences [31, 32].

4.2 Methods

4.2.1 Data collection

The underlying study is part of a larger field study that was conducted in 54 classrooms of 21 primary schools in the Netherlands in the spring of 2017 [15]. Out of the 21 primary schools studied, 17 schools (40 classrooms) (with 949 children) apply the traditional educational system, while the remaining five schools (14 classrooms) (with 196 children) adopt a more flexible education approach based on different educational theories such as Jena, Montessori or Dalton. Based on that, in this study, these two different types of schools were named “traditional schools” and “non-traditional schools”, respectively. The survey involved 1145 school children, consisting of 577 boys and 568 girls with a mean age of 10 years (9-12). All parents of the participating children were informed before the survey and they all signed a consent letter to allow their children to participate in this survey. Researchers handed out the questionnaire to every child in their own classrooms and collected the questionnaires as soon as the children were finished. Participants were given the opportunity to skip any questions or even withdraw their participation at any time. The detailed information about the selection of schools and the general procedure of the survey is presented in Bluysen et al. [15].

The children's questionnaire was based on the questionnaires used in SINPHONIE [33], a European-wide study in schools, and on a visual comfort study performed in Italy [34]. It contained five parts: general questions, questions about health, questions about the classroom environment, questions about individual control, and questions about their home. The questionnaire was made of 37 questions in total, and on average participants spent about 30 minutes to fill it out. In order to help children understand some of the questions, a few cartoon illustrations were included in the questionnaire. Besides, a short introduction was given before children filled in the questionnaire, and they could ask the researchers present in case they were confused about the questions.

This paper focuses on the questions concerning classroom environment and individual control. For the classroom environment, children's perceptions of comfort in terms of temperature, draught, smell, noise, and light in their classrooms are included. For individual control, two questions are included: the preference for six existing ICDs (including a heated chair, a heated desk, a heated back, a desk lamp, a personal ventilator and a headphone), and the importance of 10 indoor environmental factors to the children's school performance (including feet temperature, air temperature, chair temperature, scent, fresh air, light on desk, light on board, hearing teacher, outdoor sound, indoor sound). These factors were rated on a scale from 0 to 10 (10: very important, 0: not important at all). This rating is named the 'importance index' in this paper.

4.2.2 Data analysis

The data were analysed in four steps using SPSS version 23.0 (SPSS Inc. Chicago, IL, USA). First, the basic information (e.g. the mean and standard deviation of school children's comfort perceptions, importance indexes of environmental factors, preferences of ICDs) using descriptive analysis. The answers of school children were analysed at classroom level. It is worth mentioning that a new database was created based on the mean values in each classroom, and all the analysis conducted at classroom level was based on this new database.

Then, the relationships between school children's comfort perceptions and their preferences for ICDs were determined, not only at classroom level using bivariate correlations, but also at the individual level using Chi-squared tests. It should be noted that both the descriptive analysis and correlation analysis were conducted not only for all data together, but also for the traditional schools and non-traditional schools separately, since the differences in responses between the two types of schools could not be ignored [15].

Next step was the principle components analysis (PCA), which is recommended as the preparational step of any multivariate analysis to identify the structure of the dataset. It has several functions, such as data reduction, outlier detection, variable selection, and so on [35]. The PCA was used to simplify the original data into a smaller number, reflecting the large proportion of information contained in the original ones. It can be seemed as the data preparation for the next analysis, namely cluster analysis. As recommended by Field [36], the detailed setting of this analysis was as follows: the extraction was based on eigenvalues (Eigenvalues over 1); the rotation method was varimax; the cases with missing values were pairwise excluded (exclude the cases pairwise); and 0.4 was seen as a significant factor loading (suppress absolute values less than 0.4). This analysis was performed on the variables related to children's comfort perceptions and importance indexes, separately.

Lastly, the two-step cluster analysis was conducted using the new variables (components) identified by the PCA. The two-step cluster analysis has several reasons to be selected as the method in this study. Firstly, it is the only type of cluster analysis that permits continuous and categorical data to be analysed simultaneously. Secondly, two-step cluster analysis automatically selects the optimal number of clusters. Thirdly, it is suitable for large data sets [37, 38]. Besides, the two-step cluster analysis has been successfully used before in research studies [37] and has been proved to be an adequate approach to identify occupants' archetypes [39].

In this analysis, only traditional school children's data were used, because of the significant difference between children of traditional and non-traditional schools and the insufficient data of non-traditional school children. For the detailed setting of the two-step cluster analysis, the option of optimum number of clusters, log-likelihood distance measure and Akaike's Information Criterion were selected. After the analysis, according to Norušis [38], four tests were conducted to validate the final solution model. The first test is to determine the silhouette coefficient which is a measure of cohesion and separation that should be higher than the recommended level 0.0. Secondly, Chi-squared tests and ANOVA are conducted, to confirm that each variable was statistically significant related to these clusters. The third test checks whether all variables have a predictor importance higher than 0.02. Finally, in the last test the database is randomly split into two, and the final solution is applied to each of them, in order to check whether the outcome is similar.

4.3 Results

4.3.1 Descriptive analysis

The field study [15] collected children's comfort perceptions in classrooms by directly asking them 'Can you hear/smell/see...'. If they gave an affirmative answer (yes or sometimes), then they needed to answer a follow up question: 'Are you bothered by the noise/smell/light...?'. The affirmative answers to these questions were regarded as discomforts in this study. In general, as has been reported in [15], children felt less comfortable in classrooms of traditional schools than in non-traditional ones. 'Noise' caused the most discomfort (87% felt uncomfortable), 'Smell' was second (63% was bothered), sunlight third (42% was bothered), followed by 'Thermal discomfort' (35% was bothered), and 'Artificial light' and 'draught' came last (12% and 8% was bothered, respectively).

Figure 4.1 illustrates the mean value and standard deviation of the importance indexes of environmental factors. In general, all the importance indexes were higher in the traditional classrooms than in the non-traditional ones. 'Hearing teacher', with the highest average score and the lowest standard deviation (8.6 ± 0.55 for all classrooms, 8.6 ± 0.58 for traditional classrooms, 8.4 ± 0.34 for non-traditional classrooms) ranked first. This means children thought that 'Hearing teacher' is the most important impact on their school performance. The second and third most important factors were 'Fresh air' (7.9 ± 0.69 for all classrooms, 8.0 ± 0.68 for traditional classrooms, 7.5 ± 0.57 for non-traditional classrooms) and 'Air temperature' (7.2 ± 0.79 for all classrooms, 7.4 ± 0.70 for traditional classrooms, 6.5 ± 0.78 for non-traditional classrooms). 'Chair temperature' and 'Feet temperature' were the two least important factors, with average importance indexes lower than 5.0 (around 5.0 for traditional classrooms, around 4.2 for non-traditional classrooms), which could indicate that children didn't think the feet temperature and chair temperature are important for their school performance.

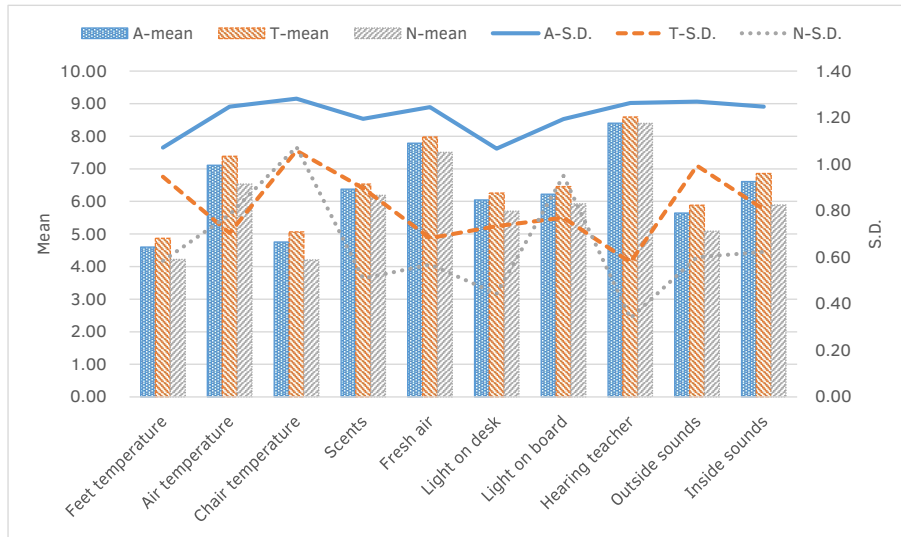

FIG. 4.1 Importance index of indoor environmental factors in all (A), traditional (T), and non-traditional (N) classrooms.

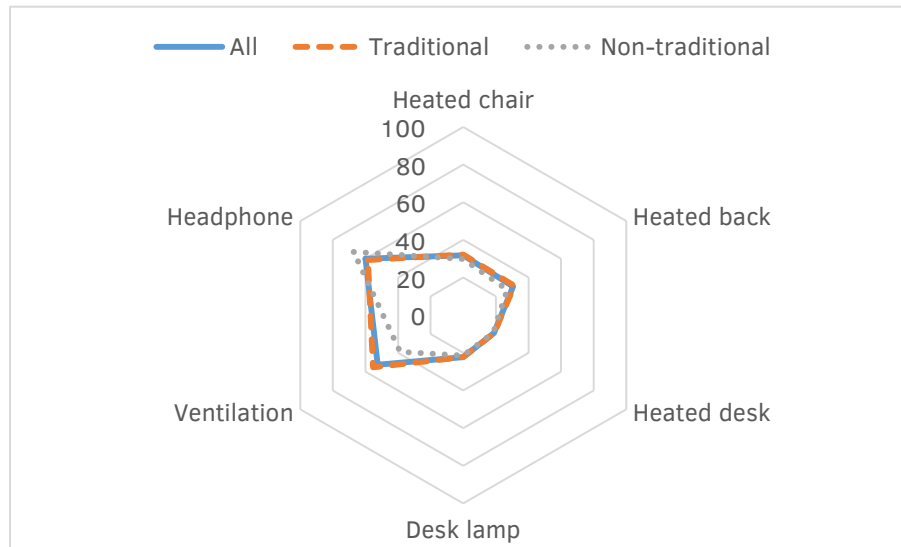

FIG. 4.2 Preference of the ICDS indicated by the school children.

Figure 4.2 depicts the results of the school children's preferences for ICDs. The most preferred device, according to the children's answers, was 'Headphone': around 60% of the children in a classroom of both traditional and non-traditional schools, indicated that they wanted to have a headphone. This combined with the highest importance index of 'hearing teacher' might indicate that the acoustical quality was the biggest problem for almost all the classrooms. The 'Ventilator at desk' was the second most favourite device: 53% of children, on average, in a classroom expressed interest in it. This also corresponded to the second and the third highest importance index of 'Fresh air' and 'Air temperature'. With respect to the other devices, only less than one third of children preferred to have them. From the comparison of the results of the traditional and the non-traditional schools, it can be concluded that the 'Headphone' is the only device that was more preferred by children from non-traditional schools, while all the others were more preferred by children from traditional schools.

4.3.2 Correlation analysis

Table 4.1 shows the relationship between school children's perceived comfort conditions and their preferences for ICDs. Almost no statistically significant relationship was found at classroom level, except for the one between 'bothered by draught' and 'preference for a ventilator' for the classrooms of all schools ($P_A=0.003$) as well as for the classrooms of the traditional schools separately ($P_T=0.003$).

At child level, relationships were found for all aspects. For the thermal aspect, the statistically significant relationship was only found between all school children's 'preference for a heated back' and their 'thermal discomfort' ($P_A=0.023$). For the air aspect, all school children's 'annoyance by draught' and 'smell' were related to their 'preference for a ventilator' ($P_A=0.000$), and these relationships were also found among children of traditional schools and children of non-traditional schools separately (for draught, $P_T=0.000$, $P_N=0.036$; for smell, $P_T=0.005$, $P_N=0.019$). For the visual aspect, all school children's 'annoyance by sunlight' was related to their 'preference for a desk lamp' ($P_A=0.016$), while if separated these children based on their school type, then this relationship could only be found among traditional school children ($P_T=0.034$). For the acoustical aspect, school children's 'annoyance by noise' was related to their 'preference for a headphone' ($P_A=0.000$), while this relationship can only be found among traditional school children ($P_T=0.001$) as well. These relationships indicate that every child's preference was only related to his or her own comfort perception, and these relationships could not be generalized at classroom level.

TABLE 4.1 Correlations between school children's comfort perceptions and their preference of ICDS.

Comfort perceptions	Preference of ICDS	All classrooms (P_A)		Traditional classrooms (P_T)		Non-traditional classrooms (P_N)	
		Classroom level	Child level	Classroom level	Child level	Classroom level	Child level
Thermal discomfort	Heated chair	0.158	0.809	0.311	0.961	0.075	0.805
	Heated back	0.244	0.023	0.382	0.104	0.252	0.076
	Heated desk	0.075	0.213	0.178	0.413	0.130	0.238
Bothered by draught	Ventilator at desk	0.003	0.000	0.003	0.000	0.197	0.036
Bothered by smell	Ventilator at desk	0.096	0.000	0.128	0.005	0.342	0.019
Bothered by sunlight	Desk lamp	0.779	0.016	0.355	0.034	0.112	0.258
Bothered by artificial light	Desk lamp	0.851	0.082	0.680	0.103	0.780	0.664
Bothered by noise	Headphone	0.636	0.000	0.302	0.001	0.915	0.180

Notes: P_A , P_T , P_N : p -values of Spearman's rank and Chi-squared test for class level and child level respectively; p -values in bold highlighted are the correlations with statistical significance ($P < 0.05$).

Table 4.2 shows the results of correlations between school children's comfort perceptions and the importance indexes of environmental factors. No relationship was found at classroom level except for the air aspect. For air quality, in all classrooms, the percentage of children 'bothered by smell' was related to the 'importance of scents' ($P_A=0.023$). In classrooms of traditional schools, relationships were established between the percentage of children 'bothered by smell' and the 'importance of scents' ($P_T=0.042$), and between the percentage of children 'bothered by smell' and the 'importance of fresh air' ($P_T=0.049$). While in classrooms of non-traditional schools, a relationship was found between the percentage of children 'bothered by draught' and the 'importance of scents' ($P_N=0.021$).

TABLE 4.2 Correlations between school children's comfort perceptions and importance indexes.

Comfort perceptions	Environmental factors	All classrooms (P_A)		Traditional classrooms (P_T)		Non-traditional classrooms (P_N)	
		Classroom level	Child level	Classroom level	Child level	Classroom level	Child level
Thermally uncomfortable	Feet temperature	0.934	0.623	0.369	0.376	0.699	0.115
	Air temperature	0.138	0.575	0.605	0.777	0.864	0.585
	Chair temperature	0.512	0.933	0.079	0.676	0.781	0.618
Bothered by draught	Scents	0.976	0.218	0.783	0.367	0.021	0.330
	Fresh air	0.615	0.125	0.362	0.086	0.728	0.868
Bothered by smell	Scents	0.023	0.053	0.042	0.081	0.185	0.791
	Fresh air	0.054	0.702	0.049	0.922	0.932	0.913
Bothered by sunlight	Light on desk	0.739	0.008	0.975	0.013	0.137	0.511
	Light on board	0.669	0.162	0.492	0.397	0.516	0.150
Bothered by artificial light	Light on desk	0.604	0.147	0.782	0.057	0.578	0.168
	Light on board	0.904	0.554	0.816	0.209	0.881	0.032
Bothered by noise	Hearing teacher	0.376	0.654	0.632	0.620	0.271	0.723
	Outside sounds	0.106	0.005	0.293	0.118	0.634	0.009
	Inside sounds	0.086	0.005	0.379	0.028	0.527	0.134

Notes: P_A , P_T , P_N : p-value of Spearman's rank; p-values in bold highlighted are the correlations with statistical significance ($P < 0.05$).

At child level, relationships were found in both visual and acoustical aspects. For visual quality, 'bothered by sunlight' was related to the 'importance of light on desk' for all school children ($P_A=0.008$), and it was also true among children of traditional schools separately ($P_T=0.013$), while for children of non-traditional schools, a relationship was found between 'bothered by artificial light' and the 'importance of light on board' ($P_N=0.032$). For acoustical quality, all school children's perception of 'bothered by noise' was related to the 'importance of outside sounds' ($P_A=0.005$) and the 'importance of inside sounds' ($P_A=0.005$), while it was only related to the 'importance of inside sounds' for children of traditional schools ($P_T=0.028$) and only related to the 'importance of outside sounds' for children of non-traditional schools ($P_N=0.009$). However, for the thermal aspect, no relationship, neither at classroom level nor at child level, could be found between children's 'thermal discomfort' and the 'importance of temperature'.

4.3.3 Principal component analysis

Using PCA, three components were identified related to comfort perceptions. Component 1 has a substantial loading for 'bothered by sunlight' and 'bothered by artificial light'. These variables are important for learning: they both influence the way reading on the board and/or at the desk. Therefore, component 1 was labelled as 'discomfort - related to learning'. Component 2 had a loading for 'bothered by smell' and 'bothered by noise', which are annoyances caused by fellow classmates, according to the children's answers, therefore component 2 was labelled as 'discomfort - related to classmates'. Component 3 had high loading for 'thermal discomfort' and 'bothered by draught' which are both about the classroom conditions, so component 3 was labelled as 'discomfort – related to classroom conditions'.

With respect to the importance indexes, the result of PCA suggested four components. 'Feet temperature' and 'chair temperature' were highly loaded in Component 1 and named 'important – temperature'. 'Fresh air', 'air temperature' and 'scent' were loaded in Component 2, which was therefore named 'important – air'. 'Light on board', 'light on table' and 'hearing teacher' were loaded in Component 3 and named 'important – learning media. And the other variables about sound were loaded in Component 4 and named 'important – sound'.

4.3.4 Two-step cluster analysis

In order to categorize the children of traditional schools, a two-step cluster analysis was conducted using the new variables generated by the PCA, and revealed six clusters, with 680 children (269 children, as incomplete sample, were automatically excluded by the process of factor analysis and Two-step analysis). The silhouette coefficient of the final solution is 0.3. The predictor importance of these variables in the final solution were: comfort-smell and noise (1.00) and comfort -thermal and draught (0.83), followed by important-temperature (0.35), comfort- light (0.27) and important - light (0.21), important –air being the least important (0.04). And all of these variables were confirmed to be statistically significant related to the six clusters. Additionally, after splitting the database in halves, only minor changes occurred (Table 4.3). All of these indicated that the six-cluster solution was justified [38].

TABLE 4.3 Cluster input with predictor importance.

Predictor importance	Final solution	First half solution	Second half solution
0.60-1.00	Discomfort - classmates (1.00) Discomfort - classroom conditions (0.93) Discomfort - learning aspects (0.60)	Discomfort - classmates (1.00) Discomfort - classroom conditions (0.66) Discomfort - learning aspects (0.65)	Discomfort - classmates (1.00) Discomfort - classroom conditions (0.82) Discomfort - learning aspects (0.73)
0.20-0.59	Important - temperature (0.39) Important - sound (0.30)	Important - learning media (0.35)	Important - air (0.37) Important - learning media (0.28)
0.00-0.19	Important - learning media (0.05) Important - air (0.02)	Important - temperature (0.17) Important - air (0.06) Important - sound (0.02)	Important - temperature (0.09) Important - sound (0.04)

4.3.5 Description of clusters

The description of clusters was based on data related to the school children's general and personal information, health status, comfort perceptions, preferences for ICDs, and the importance indexes of environmental factors. All of this information is presented in the Table 4.4.

TABLE 4.4 Characteristics of school children in different clusters.

	C1: Sound concerned (22.1%)	C2: All concerned (20.1%)	C3: Smell and sound concerned (19.1%)	C4: Thermal and draught concerned (11.6%)	C5: Light concerned (7.8%)	C6: Nothing concerned (19.3%)	Total
Personal information							
Gender							
Girl	51.3	58.4	53.1	57.0	50.9	47.3	52.9
Boy	48.7	41.6	46.9	43.0	49.1	52.7	47.1
Age (mean)	9.99	9.83	9.92	10.10	10.40	10.15	10.07
Ware glass/ lenses							
Yes	10.7	17.5	15.5	23.4	18.9	16.8	16.2
No	89.3	82.5	84.5	76.6	81.9	83.2	83.8
Commute methods							
Walking	33.3	40.4	36.7	36.7	52.8	41.2	38.8
Biking	51.3	49.3	47.7	46.8	34.0	51.1	48.3
Car	15.3	10.3	15.6	16.5	13.2	7.6	12.9
Commute time (mean)	6.53	6.55	6.91	6.68	6.35	7.01	6.73
Position in class (vertical)							
Front	37.6	43.5	34.9	35.9	26.5	30.7	36.0
Middle	41.6	42.6	48.6	40.6	41.2	48.5	44.4
Back	20.8	13.9	16.5	23.4	32.4	20.8	19.6
Near the window	52.9	49.4	56.5	56.1	52.8	47.5	52.3
Neat the door	36.5	39.1	37.6	26.3	41.7	36.3	36.3
Near the window and door	10.6	11.5	5.9	17.5	5.6	16.3	11.4
Disease							
Asthma*	4.7	6.7	2.4	12.8	15.1	4.7	5.3
Bronchitis	4.7	0.0	1.4	2.3	2.7	1.2	1.9
Hay fever*	16.4	19.8	14.3	19.7	30.8	8.8	16.2
Rhinitis	23.4	19.7	15.9	18.4	32.1	12.7	18.7
Allergies*	27.7	22.1	24.2	23.4	47.2	21.6	25.0
Eczema*	19.3	16.8	20.5	13.2	34.0	9.5	17.2
Diabetes	0.0	2.1	0.0	0.8	0.0	0.0	0.6
Symptoms							
Dry eyes	5.5	7.4	5.6	9.0	17.6	8.6	7.6
Itchy eyes*	14.2	16.2	9.4	18.2	27.5	16.3	15.3
Stuffed nose	6.7	15.3	8.7	16.7	17.6	9.9	11.3
Runny nose	7.5	11.8	12.7	11.8	10.0	10.1	10.3
Sneezing	14.0	18.5	21.1	11.5	28.8	15.4	17.2
Dry throat	9.5	16.2	10.3	13.2	26.0	9.4	12.4

>>>

TABLE 4.4 Characteristics of school children in different clusters.

	C1: Sound concerned (22.1%)	C2: All concerned (20.1%)	C3: Smell and sound concerned (19.1%)	C4: Thermal and draught concerned (11.6%)	C5: Light concerned (7.8%)	C6: Nothing concerned (19.3%)	Total
Difficult breathing*	8.8	7.4	0.8	9.1	10.0	7.8	6.8
Dry, itchy skin*	10.1	6.6	6.3	5.1	19.6	2.3	7.2
Headache	14.1	19.0	22.7	17.9	21.2	15.3	17.8
Comfort perception							
Thermal discomfort**	34.0	42.3	40.8	62.0	43.4	27.5	39.7
Bothered by draught**	0.7	0.0	2.3	100.0	5.7	0.8	12.8
Bothered by smell**	94.0	97.8	100.0	84.8	73.6	22.1	79.4
Bothered by noise**	100.0	100.0	100.0	94.9	96.2	58.0	91.0
Bothered by sunlight**	34.0	63.5	36.9	43.0	94.3	25.2	44.6
Bothered by artificial light**	3.3	8.8	0.0	16.5	100.0	2.3	12.6
Importance index							
Feet temperature**	2.8	7.1	4.9	5.6	5.9	4.6	5.1
Air temperature**	6.5	7.9	8.1	6.9	8.0	6.9	7.4
Chair temperature**	3.3	7.8	4.6	5.5	6.5	4.4	5.3
scent**	6.6	6.9	6.4	6.9	7.0	6.4	6.7
Fresh air**	7.9	7.4	8.7	7.6	8.2	8.1	8.0
Light on table**	5.2	6.9	6.6	6.7	7.8	6.2	6.6
Light on board**	5.4	6.7	6.9	7.1	7.8	6.6	6.8
Hearing teacher**	8.6	8.0	9.4	8.2	8.9	9.0	8.7
Outside sound**	7.5	7.0	2.8	6.9	6.6	5.3	6.0
Inside sound**	8.5	7.1	5.0	7.2	7.1	6.5	6.9
Preference							
Heated chair**	24.0	42.3	34.6	48.1	45.3	26.0	34.6
Heated back**	24.0	42.3	33.8	53.2	49.1	21.4	34.4
Heated desk**	13.3	24.1	20.8	38.0	39.6	13.7	21.9
Desk lamp*	21.3	29.2	23.8	24.1	22.6	22.1	24.0
Ventilator**	60.0	61.3	67.7	41.8	66.0	49.6	58.1
Headphone*	62.0	68.6	55.4	65.8	69.8	56.5	62.1

Notes: * means $p < 0.05$; ** means $p < 0.001$.

Cluster 1: Sound concerned

General information

Cluster 1 was the largest cluster with a sample size of 150, including 77 (51.3%) girls and 73 (48.7%) boys, representing 22.1% of all cases. The average age of children in Cluster 1 was 10.0 years (SD=1.3). This cluster had the smallest percentage (10.7%) of children who wore glasses/lenses. Besides, it also had the smallest percentage of children who came to school by walking, the largest percentage of children who came by bike, and the remaining 15.3% of children came by car.

Characteristics of children

The first cluster represented the highest percentage of children bothered by noise (100.0%). Besides, the percentage of children bothered by smell (94.0%) was also slightly higher compared to other clusters. However, the other discomfort perceptions were not obvious in this cluster, the percentage of children bothered by thermal discomfort (34.0%), draught (0.7%), sunlight (34.0%) and artificial light (3.3%) were all lower than the average levels. For the importance of 10 environmental factors, children in cluster 1 represented a relatively negative opinion, except for the outside sound (7.5) and inside sound (8.5), which were the highest among all the clusters. But for the others, such as feet temperature (2.8), chair temperature (3.3), light on table (5.2) and light on board (5.4), the importance indexes were the lowest among all clusters. Considering its highest percentage of children bothered by noise and highest importance indexes of indoor sound and outdoor sound, this cluster was named the 'Sound concerned cluster'.

Health condition of children

In general, children in cluster 1 had a high incidence of diseases. the percentage of the children who reported suffering from bronchitis (4.7%), was highest among all clusters; for hay fever (16.4%), rhinitis (23.4%), allergies (27.7%) and eczema (19.3%), the percentages of children were higher than the average level. Only the prevalence of diabetes (0.0%) and asthma (4.7%) were lower than in other clusters. In terms of building-related symptoms, the most prevalent ones were difficulty breathing (8.8%) and dry, itchy skin (10.1%). The other symptoms showed lower prevalence in this cluster, with the lowest prevalence of dry eyes (5.5%), stuffy nose (6.7%), runny nose (7.5%) and headache (14.1%), and the second lowest prevalence of itchy eyes (14.2%), sneezing (14.0%), and dry throat (9.5%).

Preference of ICDs

Cluster 1 showed lower preference for the offered ICDs. Children in this cluster had the lowest percentage who reported their preference for a heated chair (24.0%), a heated desk (13.3%), and a desk lamp (21.3%), the second lowest percentage who reported desire for a heated back (24.0%). Only for a ventilator (60.0%) and headphones (62.0%), more than half children in this cluster reported they wanted to have them, but these percentages were still lower than the average level.

Cluster 2: All concerned

General information

Cluster 2 was the youngest group, with an average age of 9.8 years (SD=1.6). It comprised of 80 (58.4%) girls, which was the highest girls' proportion among all clusters, and 57 (41.6%) boys, in total 137 children which represented 20.1% of the whole database. About 18% of children in this cluster wore glasses/lenses. For commuting, the ratio of walking, bike and car was 4:5:1.

Characteristics of children

Cluster 2 had a relatively high percentage of children bothered by thermal discomfort (42.3%), smell (97.8%), noise (100.0%) and sunlight (63.5%), while a relatively low percentage of children bothered by draught (0.0%) and artificial light (8.8%). Children in cluster 2 reported the second highest average importance index for the 10 environmental factors, and these important indexes varied in a small range, only from 6.7 to 8.0. This means that for these children, all of those factors are relatively important for their school performance. The high percentages of children bothered by almost all factors of IEQ and high importance indexes for all factors made this cluster to be the 'All concerned cluster'.

Health condition of children

Cluster 2 had the highest percentage of children with diabetes (2.1%), and the lowest percentage of children with bronchitis (0.0%), while the other diseases were close to the average level. For building-related symptoms, this cluster had a relatively high prevalence, with a higher than average percentage of children suffering from almost all symptoms except for dry eyes (7.4%) and dry itchy skin (6.6%).

Preference of ICDs

Children in cluster 2 showed interests in all of the six offered ICDs. Most of the children were interested in a desk lamp (29.2%), the second largest percentage of children who wanted to have headphones (68.6%), and the third largest percentage who wanted to have the other devices. All in all, in cluster 2 the percentages of children who wanted to have these devices were all higher than the average level.

Cluster 3: Smell and Sound concerned

General information

Cluster 3 comprised of 130 children, including 69 (53.1%) girls and 61 (46.9%) boys, representing 19.1% of the database. The average age of children in this cluster was 9.9 years (SD=1.6). 15.5% of them wore glasses/lenses. For commuting to school, about 37% of children in this cluster selected walking, 48% selected bike, and 16% selected car.

Characteristics of children

The discomfort perceptions reported by children in cluster 3 mainly concerned noise and smell; all children in this cluster were bothered by them. However, no child in this cluster reported being bothered by artificial light. The percentages of children who were bothered by the other discomfort sources had average levels. Children in this cluster showed the largest range of Importance index scores: from 2.8 to 9.4. This cluster reported the highest importance indexes for air temperature (8.1), fresh air (8.7) and hearing the teacher (9.4), and the lowest importance indexes for scent (6.4), outside sound (2.8) and inside sound (5.0). For the other factors, the importance indexes reported in this cluster were around the average level. Children in this cluster considered noise and smell as the most annoying aspects, and also reported the highest importance indexes for fresh air and hearing the teacher well. Therefore, this cluster was named the 'Sound and Smell concerned cluster'.

Health condition of children

In general, children in cluster 3 had relatively low incidences of diseases. The percentage of children suffered from asthma (2.4%) and diabetes (0.0%) were the lowest among all clusters. Bronchitis (1.4%), hay fever (14.3%), rhinitis (15.9%), and allergies (24.2%), were also lower than the average level. While only eczema (20.5%) had the second highest prevalence among all clusters. With respect to building-related symptoms, in cluster 3, the top three were headache (22.7%),

sneezing (21.1%) and runny nose (12.7%), and the percentages of children suffering from these symptoms were either the highest or the second highest among all clusters. However, for other symptoms, the percentages were lower than the average level.

Preference of ICDs

Cluster 3 presented the highest percentage of children who preferred a ventilator (67.7%). Children in this cluster didn't show much interest in the other devices: preferences for other devices were all lower than average and especially for headphones (55.4%), which presented the lowest percentage among all clusters.

Cluster 4: Thermal and Draught concerned

General information

Cluster 4 was the second smallest cluster, with the second highest percentage of girls. It comprised of 79 children, including 45 (57.0%) girls and 34 (43.0%) boys, representing 11.6% of the database. The average age of children in this cluster was 10.1 years (SD=1.44). Cluster 4 was the cluster with the highest percentage (23.4%) of children who wore glasses/lenses, it also had the highest percentage (16.5%) of them came to school by car.

Characteristics of children

In general, children in cluster 4 felt more discomfort than the others. This cluster had higher than average percentages of children who reported being bothered by almost all the discomfort sources except the sunlight which still rated third highest. Besides, it had the highest percentages for bothered by thermal discomfort (62.0%) and draught (100.0%). Interestingly, the importance indexes distribution in cluster 4 was almost the opposite of cluster 3, which means that the factors with higher scores in cluster 3 were always rated lower in this cluster and vice versa. For example, children in cluster 4 reported the lowest score for air temperature (6.9), and the second lowest score for fresh air (7.6) and hearing teacher (8.2), while cluster 3 had the highest importance indexes for these factors. For the other seven factors, children in this cluster rated higher than average scores and higher than the scores reported by cluster 3 as well. Cluster 4 was named the 'Thermal and Draught concerned cluster' because it had the highest percentages of children bothered by thermal discomfort and draught.

Health condition of children

Cluster 4 had an average health status compared to the other clusters. Neither the highest nor the lowest prevalence of any disease appeared in this cluster. While for the building-related symptoms, children in cluster 4 reported the unhealthiest status. The prevalence of almost all the symptoms were higher than average, only the prevalence of sneezing (11.5%) and dry, itchy skin (5.1%) were lower than the average.

Preference of ICDs

Cluster 4 had the highest percentages of children preferring a heated chair (48.1%) and a heated back (53.2%) and the second highest percentage of children preferring a heated desk (38.0%). Such preferences correspond to these children's thermal discomfort perceptions. Besides, this cluster had the lowest percentage of children preferring a ventilator, which might be related to their annoyance caused by draught. For the desk lamp (24.1%) and headphones (65.8%), the percentages were around the average level.

Cluster 5: Light concerned

General information

Cluster 5 was the smallest cluster with 53 children, of which 27 (50.9%) were girls, representing 7.8% of the whole database. It is also the oldest cluster, with a mean age of 10.4 years (SD=1.02). About 18.9% of children wore glasses/lenses. More than half, which was the highest percentage, of them came to school by walking, while only 34%, which was the lowest percentage, of them came by bike.

Characteristics of children

Children in cluster 5 were prone to be bothered by light; this cluster had the largest percentages of children who considered sunlight (94.3%) and artificial light (100.0%) as sources of annoyance. It also has the second largest percentage reporting thermal discomfort. As far as the importance indexes were concerned, this cluster presented the highest average importance indexes, and all its indexes were higher than average. In addition, they reported the highest rating for scent (7.0), light on table (7.8) and light on board (7.8), which might be related to their annoyances caused by sunlight and artificial light. Cluster 5 was named the 'Light concerned cluster' because it has the highest percentages of children bothered by sunlight and artificial light, and these children also reported the highest importance indexes for light on table and light on board.

Health condition of children

Cluster 5 had the worst health status. It had the highest prevalence for three conditions: hay fever (21.2%), rhinitis (26.8%) and allergies (29.1%), and the second highest prevalence of the other three diseases: asthma (7.9%), bronchitis (2.7%) and eczema (19.3%). This cluster also had the highest provenance of building-related symptoms. It had the highest percentages of children suffering from almost all the symptoms except headache (21.2%) and runny nose (10.0%).

Preference of ICDs

Children in cluster 5 showed a relatively higher interest in almost all of the ICDs. The percentages of children who wanted to have headphones (69.8%) and a heated desk (39.6%) were the highest, and the percentages of children who preferred a heated chair (45.3%), a heated back (49.1%) and a ventilator (64.7%) were the second highest. The desk lamp (22.6%), however, had a lower than average level, and this might be due to the fact that all the children in the cluster reported being bothered by artificial light.

Cluster 6: nothing concerned

General information

This cluster comprised of 131 children, 22.0% of the whole database, and it has the largest percentage of boys (52.7%). The average age of children in this cluster is 10.2 years (SD=0.93). 17% of them wore glasses/lenses. It was the cluster with fewest (7.6%) children coming to school by car.

Characteristics of children

Children in cluster 6 felt more comfortable than the rest, the percentages of children bothered by the assessed IEQ sources were much lower than the average levels. Besides, this cluster had the lowest percentage for being bothered by thermal aspects (27.5%), smell (22.1%), noise (58.0%), and sunlight (25.2%). The importance indexes reported by children were relatively lower. They rated the lowest scores for air temperature (6.3) and scent (6.4), and the second lowest scores for feet temperature (4.6), chair temperature (4.4), light on table (6.2), light on board (6.6), outside sound (5.3) and inside sound (6.5). The low percentage of children bothered by all of the IEQ aspects of classrooms and the low important indexes of the factors made this cluster to be the 'Nothing concerned cluster'.

Health condition of children

With respect to the health status, cluster 6 was the healthiest cluster. It had the lowest prevalence of hay fever (8.8%), rhinitis (12.7%), allergies (21.6%), eczema (9.5%) and diabetes (0.0%), and the second lowest prevalence of asthma (4.7%) and bronchitis (1.2%). Furthermore, they also had the lowest incidences of dry throat (9.4%) and dry, itchy skin (2.3%).

Preference for ICDs

Children in cluster 6 showed the least interest in the ICDs. The percentages of children who wanted to have them were all lower than average. Additionally, this cluster had the lowest percentage of children preferring a heated back (21.4%) and the second lowest percentages of children who preferred the other devices.

4.4 Discussion

4.4.1 Existing problems in classrooms studied

This study presents children's preferences and needs for IEQ conditions. First the global analysis was made among all schools, and subsequently, non-traditional and traditional schools were analysed separately because of the differences of school children's perceptions between these two types of schools [15]. Bluysen et al. [15] reported that although the extent of complaints in the classrooms of traditional and non-traditional schools is different, all children were bothered mostly by noise (87%), followed by smells (63%). Correspondingly, in both types of schools, according to the importance indexes of environmental factors, 'hearing teacher' and 'fresh air' were considered as very important (grade higher than 7 out of 10 scores). The analysed relationships between school children's perceptions and preferences were indeed only relevant at the child level. Similarly, the relationships between children's comfort perceptions and the importance indexes of environmental factors were also more relevant at child level than at classroom level. It seems therefore that IEQ problems in classrooms are difficult to generalize, because they differ from child to child, and so do the possible solutions. Since it is impossible to study the problem-solution relationships for each child individually, a possible way to investigate these

problem-solution relationships could be to group children into segments with similar preferences and needs. Eventually, profiles were developed based on the descriptive data of each of the segments.

4.4.2 School children's profiles

Similar to a study conducted among home occupants by Ortiz and Bluysen [34], the two-step cluster analysis proved to be a suitable method to distinguish clusters among classroom occupants, i.e. school children, and to provide better understanding of children's characteristics, preferences and needs. It provided a six-cluster solution for the children participating in this study, based on which, the school children's profiles, including their general information, comfort perceptions, health status and preferences for ICDs, were developed.

In general, these six clusters have their own particular characteristics regards to discomfort and the importance indexes. Children of the 'Sound concerned cluster' were all bothered by noise and they rated the highest scores, among all clusters, for the 'outside sound' and 'inside sound'. Children of the 'All concerned cluster' were concerned about all items assessed in their classrooms, and they had problems in all aspects of IEQ. Children of the 'Smell and Sound concerned cluster' were concerned more about air and sound. Similar as the 'Sound concerned cluster', children in this cluster were also all bothered by noise, but in terms of the importance indexes, they rated the highest scores for 'hearing teacher', while rated the lowest scores for 'inside/outside sounds'. Besides, air quality was also a focus point for these children since they were all bothered by smell and rated the highest scores for 'fresh air' and 'air temperature'. For children of the 'Thermal and Draught cluster', draught and thermal conditions of classrooms were their concerns. All of them were bothered by draught and more than half of them, which is the highest percentage, were bothered by the thermal condition. Children of the 'Light concerned cluster' were more concerned about light. These children were prone to be bothered by artificial light and sunlight, moreover, they rated the highest score for the light on desk and board. As for children of the 'Nothing concerned cluster', they were not concerned about any items in their classrooms, and they had hardly any problems with any of the aspects of IEQ, in fact the opposite of the children of the 'All concerned cluster'.

4.4.3 ICDs as a solution?

Using the information and the clusters identified by this study, methods for improving IEQ of classrooms could be customized for each cluster. Children of each cluster have significant different characteristics except for one thing: all clusters have a considerable large percentage of children reporting being uncomfortable from noise and their preferences for headphones. As a general problem, noise has been the focus of studies for 40 years [40, 41], but it seems that this problem needs to be tackled at both classroom and personal level, perhaps by using headphones as was pointed out by many children in the ‘Sound concerned cluster’. For the children of the ‘Smell and Sound concerned cluster’, both noise and air were the main problems, and a ventilator was the most preferred device. Children of the ‘Thermal and Draught concerned cluster’ had the highest percentage of children who wanted to have a heated chair and heated back, but the lowest percentage that preferred a ventilator. For the children of the ‘Light concerned cluster’, both artificial and natural light, were the main problems. Nevertheless, only less than one quarter of them preferred to have a desk lamp. For them perhaps the solution lies in the protection of sunlight, or, the possibility to control the artificial light instead of just providing them light. Future research is needed to support the insight gained in this survey in order to narrow down any possible design solutions.

The problems for the other two clusters were more complicated. Children of the ‘All concerned cluster’ felt uncomfortable with every aspect of IEQ and preferred all ICDs. Conversely, in the ‘Nothing concerned cluster’, fewer children wanted to have the proposed ICDs, they were comfortable and healthy. Changes in the IEQ conditions of their classroom cannot make them feel more comfortable, and more studies need to be done to gain insight into these clusters to better understand their characteristics and the psychological and social impact.

4.4.4 Limitations

This study had two limitations: first, the sample was limited to primary school children aged between 9 to 12 years old, and most of children were from traditional schools. Also, about one third of the children’s data were excluded in the two-steps cluster analysis because of the incompleteness of their questionnaires. Therefore, it is difficult to generalize for all children of primary schools. Second, the field-study was conducted from April to June, the outdoor climate could have had an impact on school children’s comfort perceptions, these influences are difficult to distinguish from the influence of indoor environmental quality since only one season was considered.

4.5 Conclusion

The main outcome of this study is the clustering of primary school children into six profiles including their personal characteristics, health status and preferences for IEQ and ICDS, by means of two-step cluster analysis: the 'Sound concerned cluster', the 'All concerned cluster', the 'Smell and Sound concerned cluster', the 'Thermal and Draught concerned cluster', the 'Light concerned cluster', and the 'Nothing concerned cluster'. The results indicate that children do have different annoyances and different preferences related to the IEQ in classrooms. Although more research is required to complement these findings, the children's profiles might be of help in the development of children-focused design solutions and/or devices, and to further improve the IEQ of classrooms as perceived by children.

Acknowledgements

This study was sponsored by Forbo International BV, the fellowship of Philomena Bluysen provided by the Delft University of Technology under the chair of Indoor Environment, and the China Scholarship Council (CSC). Stanley Kurvers and Marjolein E. Overtoom are thanked for their contribution to the field studies.

References

- [1] Klatte, M., J. Hellbrück, J. Seidel, and P. Leistner, Effects of classroom acoustics on performance and well-being in elementary school children: A field study. *Environment and Behavior*, 2010. 42(5): p. 659-692.
- [2] Haverinen-Shaughnessy, U., A. Borrás-Santos, M. Turunen, J.P. Zock, J. Jacobs, E. Krop, L. Casas, R. Shaughnessy, M. Täubel, and D. Heederik, Occurrence of moisture problems in schools in three countries from different climatic regions of Europe based on questionnaires and building inspections—the HITEA study. *Indoor Air*, 2012. 22(6): p. 457-466.
- [3] Chatzidiakou, L., D. Mumovic, and A.J. Summerfield, What do we know about indoor air quality in school classrooms? A critical review of the literature. *Intelligent Buildings International*, 2012. 4(4): p. 228-259.
- [4] Mendell, M.J. and G.A. Heath, Do indoor pollutants and thermal conditions in schools influence student performance? A critical review of the literature. *Indoor Air*, 2005. 15(1): p. 27-52.
- [5] Wu, W. and E. Ng, A review of the development of daylighting in schools. *Lighting Research and Technology*, 2003. 35(2): p. 111-124.
- [6] Shield, B.M. and J.E. Dockrell, The effects of noise on children at school: a review. *Building Acoustics*, 2003. 10(2): p. 97-116.
- [7] De Giuli, V., O. Da Pos, and M. De Carli, Indoor environmental quality and pupil perception in Italian primary schools. *Building and Environment*, 2012. 56: p. 335-345.
- [8] Haverin-Shaughnessy, U., M. Turunen, J. Metsämuuronen, J. Palonen, T. Putus, J. Kurnitski, and R. Shaughnessy, Sixth grade pupils' health and performance and indoor environmental quality in Finnish school buildings. *British Journal of Education Research*, 2012. 2(1): p. 42-58.
- [9] Chen, L., Jennison, B. L., Yang, W., & Omaye, S. T., Elementary school absenteeism and air pollution. *Inhalation Toxicology*, 2000. 12(11): p. 997-1016.
- [10] Zhao, Z., Z. Zhang, Z. Wang, M. Ferm, Y. Liang, and D. Norbäck, Asthmatic symptoms among pupils in relation to winter indoor and outdoor air pollution in schools in Taiyuan, China. *Environmental health perspectives*, 2008. 116(1): p. 90-97.
- [11] de Dear, R., J. Kim, C. Candido, and M. Deuble, Adaptive thermal comfort in Australian school classrooms. *Building Research & Information*, 2015. 43(3): p. 383-398.
- [12] Ekren, O., Z.H. Karadeniz, İ. Atmaca, T. Ugranlı-Cicek, S.C. Sofuoglu, and M. Toksoy, Assessment and improvement of indoor environmental quality in a primary school. *Science and Technology for the Built Environment*, 2017. 23(2): p. 391-402.
- [13] Samad, M.H.A., Z.A. Aziz, and M.H.M. Isa. Indoor environmental quality (IEQ) of school classrooms: Case study in Malaysia. in *AIP Conference Proceedings*. 2017. AIP Publishing.
- [14] Bluysen, P.M., Health, comfort and performance of children in classrooms—new directions for research. *Indoor and Built Environment*, 2017. 26(8): p. 1040-1050.
- [15] Bluysen, P.M., D. Zhang, S. Kurvers, M. Overtoom, and M. Ortiz-Sanchez, Self-reported health and comfort of school children in 54 classrooms of 21 Dutch school buildings. *Building and Environment*, 2018. 138: p. 106-123.
- [16] Zhang, D. and P. M. Bluysen, Actions of primary school teachers to improve the indoor environmental quality of classrooms in the Netherlands, *Intelligent Buildings International*, (2019) : DOI: 10.1080/17508975.2019.1617100.

- [17] Luther, M. Review of measurements in schools to improve IEQ. in *10th International Conference of Healthy Buildings, Queensland University of Technology, Brisbane, Queensland*. 2012.
- [18] Campbell, C., C. Svensson, and E. Nilsson. The challenge of meeting both acoustic and thermal comfort in 21st century school classrooms. in *INTER-NOISE and NOISE-CON Congress and Conference Proceedings*. 2014. Institute of Noise Control Engineering.
- [19] Kats, G., Greening America's Schools. *American Federation of Teachers, et al. Capital E*, 2006.
- [20] Valeski, T.N. and D.J. Stipek, Young children's feelings about school. *Child development*, 2001. 72(4): p. 1198-1213.
- [21] Pasut, W., H. Zhang, E. Arens, S. Kaam, and Y. Zhai, Effect of a heated and cooled office chair on thermal comfort. *HVAC&R Research*, 2013. 19(5): p. 574-583.
- [22] Pasut, W., H. Zhang, E. Arens, and Y. Zhai, Energy-efficient comfort with a heated/cooled chair: Results from human subject tests. *Building and Environment*, 2015. 84: p. 10-21.
- [23] Taub, M., H. Zhang, E. Arens, F. Bauman, D. Dickerhoff, M. Fountain, W. Pasut, D. Fannon, Y. Zhai, and M. Pigman, The use of footwarmers in offices for thermal comfort and energy savings in winter. 2015.
- [24] Melikov, A.K., Personalized ventilation. *Indoor Air*, 2004. 14(s7): p. 157-167.
- [25] Melikov, A.K., M. Skwarczynski, J. Kaczmarczyk, and J. Zabecky, Use of personalized ventilation for improving health, comfort, and performance at high room temperature and humidity. *Indoor Air*, 2013. 23(3): p. 250-263.
- [26] Yamakawa, K., K. Watabe, M. Inanuma, K. Sakata, and H. Takeda, A study on the practical use of a task and ambient lighting system in an office. *Journal of Light & Visual Environment*, 2000. 24(2): p. 15-18.
- [27] Tabuchi, Y., K. Matsushima, and H. Nakamura, Preferred illuminances on surrounding surfaces in relation to task illuminance in office room using task-ambient lighting. *Journal of Light & Visual Environment*, 1995. 19(1): p. 28-39.
- [28] Akhtar, S., C.G. Weigle, E.Y. Cheng, R. Toohill, and R.J. Berens, Use of active noise cancellation devices in caregivers in the intensive care unit. *Critical care medicine*, 2000. 28(4): p. 1157-1160.
- [29] Hongisto, V. Effects of sound masking on workers-a case study in a landscaped office. in *9th International Congress on noise as a Public Health Problem (ICBEN), Mashantucket, Connecticut, USA*. 2008.
- [30] CEN, C., Ventilation for Buildings: Design Criteria for the Indoor Environment. 1998.
- [31] Sarstedt, M. and E. Mooi, Cluster analysis, in *A concise guide to market research*. 2014, Springer. p. 273-324.
- [32] Punj, G. and D.W. Stewart, Cluster analysis in marketing research: Review and suggestions for application. *Journal of marketing research*, 1983: p. 134-148.
- [33] Csobod, E., I. Annesi-Maesano, P. Carrer, S. Kephelopoulos, J. Madureira, P. Rudnai, E.O. Fernandes, J. Barrero-Moreno, T. Beregszaszi, and A. Hyvärinen, SINPHONIE Schools Indoor Pollution and Health Observatory Network in Europe Final Report. *Google Scholar*, 2014.
- [34] De Giuli, V., Modeling and experimental results in daylighting analysis to improve visual comfort and to reduce energy demand in buildings. 2010.
- [35] Wold, S., K. Esbensen, and P. Geladi, Principal component analysis. *Chemometrics and intelligent laboratory systems*, 1987. 2(1-3): p. 37-52.
- [36] Field, A., Factor analysis using SPSS. *Retrieved March*, 2005. 17: p. 2009.
- [37] Rundle-Thiele, S., K. Kubacki, A. Tkaczynski, and J. Parkinson, Using two-step cluster analysis to identify homogeneous physical activity groups. *Marketing Intelligence & Planning*, 2015. 33(4): p. 522-537.
- [38] Norušis, M.J., IBM SPSS statistics 19 statistical procedures companion: Prentice Hall. *New York*, 2012. p. 375-404.
- [39] Ortiz, M.A. and P.M. Bluysen, Proof-of-concept of a questionnaire to understand occupants' comfort and energy behaviours: First results on home occupant archetypes. *Building and Environment*, 2018. 134: p. 47-58.
- [40] Bronzaft, A.L. and D.P. McCarthy, The effect of elevated train noise on reading ability. *Environment and Behavior*, 1975. 7(4): p. 517-528.
- [41] Zentall, S.S. and J.H. Shaw, Effects of classroom noise on performance and activity of second-grade hyperactive and control children. *Journal of Educational Psychology*, 1980. 72(6): p. 830.

5 Impact of different acoustic conditions on school children in the Netherlands

In the previous chapters, noise was proved to be the biggest IEQ problem in classrooms of Dutch primary schools. Although many studies have confirmed the negative impact of noise on children, some details, such as the impact of different sound pressure levels and different types of noise, still need to be identified. Thus, this chapter introduces an experiment conducted in the acoustic chamber of the SenseLab to further clarify the effect of background sound on school children. It consists of two parts: the first part identifies the interaction effect of background sound type (including traffic noise, children talking and music) and sound pressure level (either 45 dB(A) or 60 dB(A)) on school children; the second part shows the impact of acoustic treatment on children's performance, sound perception, and influence assessment.

The first part of this chapter has been published as follows: Zhang, D., Tenpierik, M., & Bluysen, P. M. (2019). Interaction effect of background sound type and sound pressure level on children of primary schools in the Netherlands. *Applied Acoustics*, 154, 161-169; the second part was presented at the conference Clima 2019 in Bucharest, Romania and that has been published as follows: Zhang, D., Tenpierik, M., & Bluysen, P. M. (2019, May). The effect of acoustical treatment on primary school children's performance, sound perception, and influence assessment. In *E3S Web of Conferences* (Vol. 111). The layout of these papers has been adjusted to fit the style of this thesis.

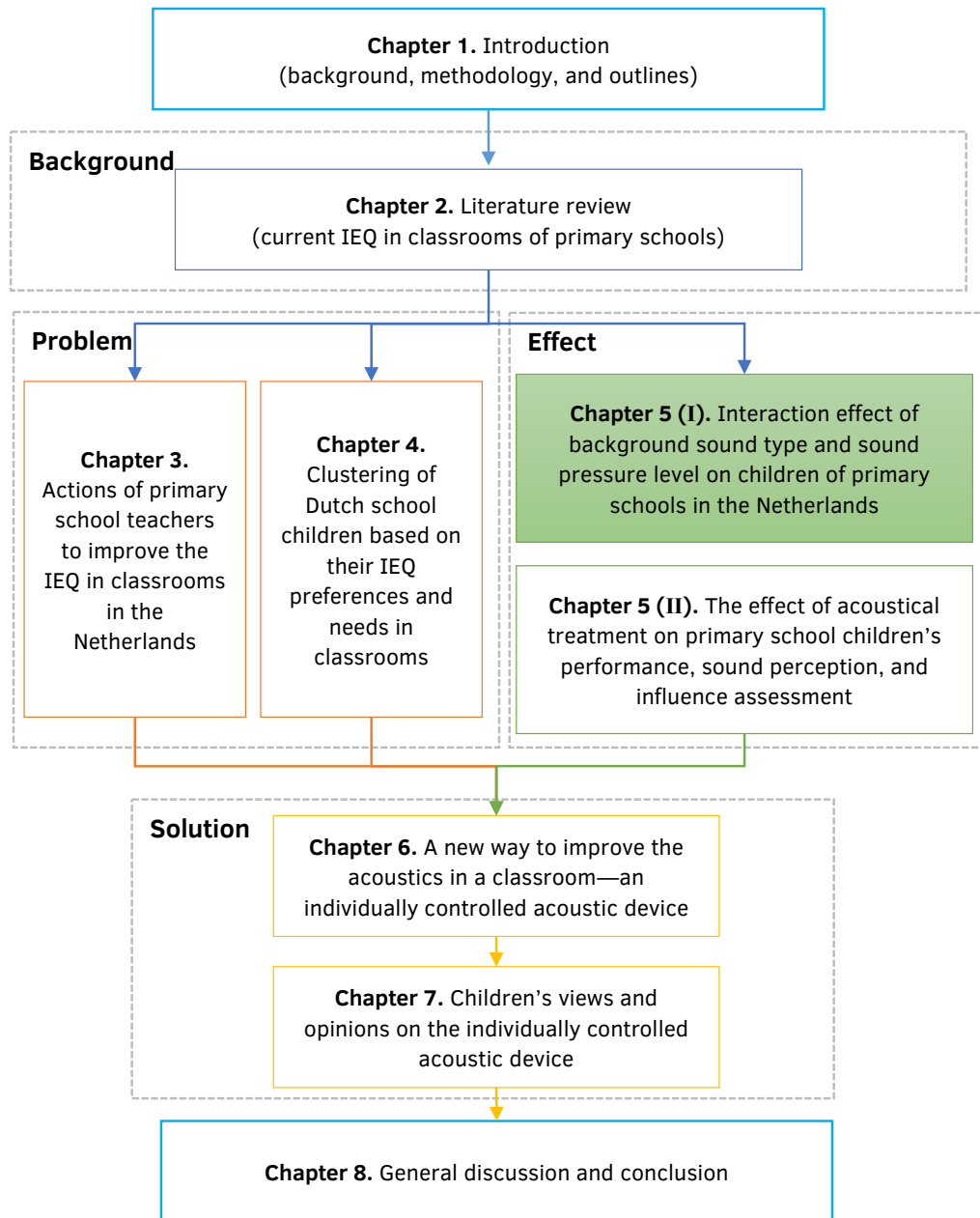

Part I / Interaction effect of background sound type and sound pressure level on children of primary schools in the Netherlands

ABSTRACT The acoustic conditions of classrooms received a lot of attention in the last decades because of its important role in school children's comfort and performance. In a previous field study of 54 classrooms from 21 schools in the Netherlands, more than 85% of the 1145 primary school children reported that they were bothered by noise in the classroom. The objective of this study is to identify the effect of background sounds on children's performance, sound evaluation and influence assessment based on a lab study conducted in the SenseLab. 335 school children (9 to 13 years old) from the previous studied schools participated in the lab study. They were subjected to a series of listening tests and evaluations in two acoustic test chambers (acoustically treated or untreated) with one of seven randomly played background sounds: 45 dB(A) or 60 dB(A) traffic noise, 45 dB(A) or 60 dB(A) children talking, 45 dB(A) or 60 dB(A) music, or no sound (≈ 30 dB(A)). A two-way ANOVA was applied to analyse the interaction effect of sound type and sound pressure level (SPL) on children's performance, sound evaluation and influence assessment in each of the chambers. Statistically significant interactions between the impact of sound type and SPL on children's phonological processing performance and their influence assessments were found in the untreated chamber.

KEYWORDS primary school children; phonological processing; noise; music; sound pressure level; interaction effect

5.1 Introduction

As a learning environment, classrooms' main function is to ensure the information of teachers can be clearly transferred to children [1]. According to a field study conducted by Bluysen et al. [2], noise is the most common annoyance for primary school children in the Netherlands; more than 85% of children reported that they were bothered by noise in their classrooms. Young children, especially younger than 13 years old, are more susceptible to noise than adults [3]. Therefore, the impact of the acoustic conditions of a classroom on children's sound perception and learning performance has attracted much concern throughout history. Many studies have examined the effects of different types of classroom noise, including external noise (e.g. aircraft noise, train noise and road traffic) and noise generated by the children themselves, while others have focused on the effect of different types of music (e.g. vocal music and instrumental music). These studies involved a large variety of performance tests including reading, mathematics, memory and attention tests. Besides, the sound pressure level (SPL) of background sound in classrooms and its impact have also been examined by several studies.

However, only few studies have compared the impact of music and noise on task performance. For these studies, their focuses were either on adults' performance [4] or on the relationship between personality (introverts or extraverts) and background sound [5, 6]. Almost none of them looked at the impact of music and noise on children's task performance. In addition, the interactions of background sound type and sound level on children's performance, sound evaluation and assessment of influence of sounds also has been neglected by these studies.

Therefore, in an attempt to fill the research gaps addressed above, 335 children from the previous studied schools were invited to participate in a series of experiments, which was part of an experimental study performed in the SenseLab under well-controlled environmental conditions [7]. The SenseLab comprises of four test chambers (to test the four indoor environmental factors separately: thermal comfort, air quality, acoustics, and light) and one experience room (for integral research of the four indoor environmental factors) [8]. This current paper shows the results of the experiments conducted in the acoustics chamber. It aims to address the effects of background sounds, including different sound types and SPLs, on children's phonological processing, sound evaluation, and influence assessment by comparing their answers under different background sound conditions. Additionally, the effect of age and gender were also taken into consideration in this paper.

5.2 Literature review

5.2.1 Impact of external noise

External noise consists of aircraft noise, train noise, road traffic noise, noise of outside people (including children on a playground), noise of lawn maintenance equipment, as well as the noise of nature, like rain. Some studies demonstrated that noise has a detrimental effect on children's performance, and this effect was more obvious on older children in primary schools because they suffer from noise in their classroom for a long time, and their school tasks require higher mental requirements [1, 9]. They also indicated that aircraft noise is more impairing than road traffic noise, which in turn is more impairing than train noise, especially in terms of the impact on long-term memory [10, 11]. However, there are also some studies indicating that noise may benefit children's performance. For example, a study conducted by Stansfeld [11] found that exposure to road traffic noise could improve children's episodic memory scores, and other studies involving white noise also concluded that continuous and persisting noise is beneficial for cognitive performance in children with Attention Deficit Hyperactivity Disorder (ADHD) [12]. Among all these external noises, road traffic, in particular cars, seems to be the most prevalent source, while aircraft noise was found to be the less common one [1].

5.2.2 Impact of internal noise

Internal noise inside classrooms includes the noise of teaching appliances (computers, projectors, etc.), noise of HVAC (Heating Ventilating and Air-conditioning) systems and plumbing systems, and noise generated by the children themselves (in their own classroom, in neighbouring classrooms or in corridors). Although in a field study conducted in 54 primary school classrooms in the Netherlands [2] children reported that the noise generated by themselves was the main annoyance in their classrooms, research into the impact of this type of noise has only started two decades ago. Hence, the knowledge could still be extended.

Shield and Dockrell [13] also found that the noise of children seems to be the dominant noise in the classrooms by conducting an internal noise survey in 140 primary school classrooms, and they proved that the presence of children, no

matter what they are doing, could increase the noise level in classrooms. Later, they examined the impact of the noise caused by children's babble on their performance (verbal and non-verbal tasks) among 158 children aged around 8 years [14]. The result showed that two different noise conditions, namely 'babble' condition (the noise created by children) and 'babble and environmental' combined condition (the noise created by children plus the environmental noise, such as sirens and lorries), affected verbal and non-verbal tasks in a different way. For the non-verbal tasks, compared with the 'base' condition (typical quiet classroom), children performed worse in the 'babble' condition, and even worse in the 'babble and environmental' condition. For verbal tasks, compared with the 'base' condition, children performed worse in the 'babble' condition, but better in the 'babble and environmental' condition. According to Shield and Dockrell [14], the different time control rules of these tasks might be one of the possible explanations of these different effects.

5.2.3 Impact of music

Music is an indispensable part of the life of adolescents who usually spend about three hours per day listening to music, which not only satisfies their emotional needs but also helps them to understand the outside world [15]. The effect of music has been studied throughout history. As early as the 1950s, music was proved to have a positive impact on comprehensive reading tasks [16, 17]. Several studies tried to find a theoretical understanding of how music affects people. Burleson [18] found music could reduce the off-task response and increase the task accuracy in psychotic children. This supported the previous studies by Fitzpatrick [19]. The reason why music could facilitate performance was explained by Richman [20]; he considered music as the mask of distractor (extraneous auditory) stimuli which could induce the off-task response. Hallam et al. [21] concluded that music could help school children to reach their arousal level so that they will perform tasks better. However, earlier studies are not consistent with these findings. Gianna and Raymond [5] compared the effect of music with high arousal potential (HA) and music with low arousal potential (LA). They found that both of them had a negative effect on task performance; and listening to HA music was more harmful than listening to LA music. This verified the conclusion of Konecni [22] and Hargreaves and North [23] that listening to music occupies cognitive capacity; so, the capacity for task performance would be impaired.

The different effects of music might be related to both the type of music and the type of task. Previous research has compared different types of music, and found a different effect of vocal music and instrumental music. Furnham et al. [24] found

the presence of lyrics could enhance the negative effect of music by analysing pupils' performance with background vocal music and instrumental music. Iwanaga and Ito [25] also concluded that vocal music was more distracting for memory tasks than instrumental music. The underlying theory could be that the lyrics may impair phonological processing, which could interfere with the processing of verbal information [5]. In addition, the task-related factors also should be taken into consideration. The general consensus is that music may have a negative impact on complex mental tasks [5]. However music also may have a positive impact on routine tasks, which was confirmed by Smith [26].

5.2.4 Academic performance tasks

Many different performance tasks were used in previous studies with regard to testing the impact of acoustic conditions or noise on children. The phonological processing test is one of the common ones. Kettle et al. [27] used a task named “odd-one-out” to test the phonological processing in children. Eight lists of three monosyllabic words or CVC (Consonant Vowel Consonant) nonwords were played via a speaker. A CVC word is a word that is made up of a consonant, vowel and consonant sound (e.g. cat, hot, tip, man, etc.) [28]. Children were asked to point out the odd one word whose initial or final sound was to be analysed. The same type of test also was used in the studies of Bradley and Bryant [29]. Spelling is also a very common test [14, 27]. Usually, in the spelling test, children were asked to write down the single words and sentences. Reading, including reading speed, reading accuracy and proof reading, is another common type of performance task used in previous studies [14, 30, 31]. Besides, memory tasks and mathematical tasks were also used as a method to measure learning performance in several studies [5, 14, 31, 32]. Detailed information of these tasks can be found in Appendix 3.A.

5.3 Method

5.3.1 Experimental setup

The acoustic experiment introduced here was part of a series of experiments in the SenseLab with children from the previous studied schools. The general procedure for these studies was introduced in the paper of Bluysen et al. [7]. The acoustic experiment was based on a three factorial randomized design. The three factors were 'sound type' (with three levels 'children talk', 'traffic' and 'music'), 'SPL' (with two levels 45 dB(A) and 60 dB(A)) and 'acoustic treatment' (with two levels 'treated' and 'untreated'). In total, 335 children from 7 primary schools participated in the experiment that took place on 10 different days between February 13th and April 5th 2018.

Acoustic test chamber

The experiment was carried out in the acoustic test chamber of the SenseLab (width 2.4 m, length 2.6 m, height 2.1 m), that was equally divided into two parts (or two chambers) by a thick curtain. The walls, floor and ceiling of the chambers comprised of sandwich panels with a core of 80 mm Polyurethane and covered by thin steel lining. One of the two chambers had 11.6 m² of "Ecophon Akusto Wall A" acoustic absorption panels attached on the three walls and ceiling, so it was named the acoustically treated chamber (chamber B). The other chamber did not have added sound absorption material, and was therefore named the untreated chamber (chamber A). The difference between these two chambers and the effect of acoustic treatment on children was reported by Zhang et al. [33]. The estimated RT of these two chambers is shown in Table 5.1.

TABLE 5.1 Estimated RT^* of the chamber.

Frequency [Hz]	$\frac{V}{6\bar{\alpha}S} \approx RT_{untreated}$ [s]	$\frac{V}{6\bar{\alpha}S} \approx RT_{treated}$ [s]
125	0.52	0.29
250	0.47	0.09
500	0.33	0.06
1000	0.24	0.06
2000	0.26	0.06
4000	0.29	0.06
Average 250-2000	0.33	0.07

Notes: * Since the two chambers are very small, modal behaviour was expected and it may therefore be difficult to define a reverberation time. The values in the table provide the calculated $V / 6\bar{\alpha}S$ (where V is the volume of the chamber [m^3], $\bar{\alpha}$ is the average coefficient [-], and S is the total geometrical area [m^2]) to give an indication of the amount of absorption in the chamber.

The layout and size of the two chambers were the same, each chamber had two small chairs and a loudspeaker placed in a corner of the room (see Figure 5.1). The loudspeaker was directed to the centre of the two chairs.

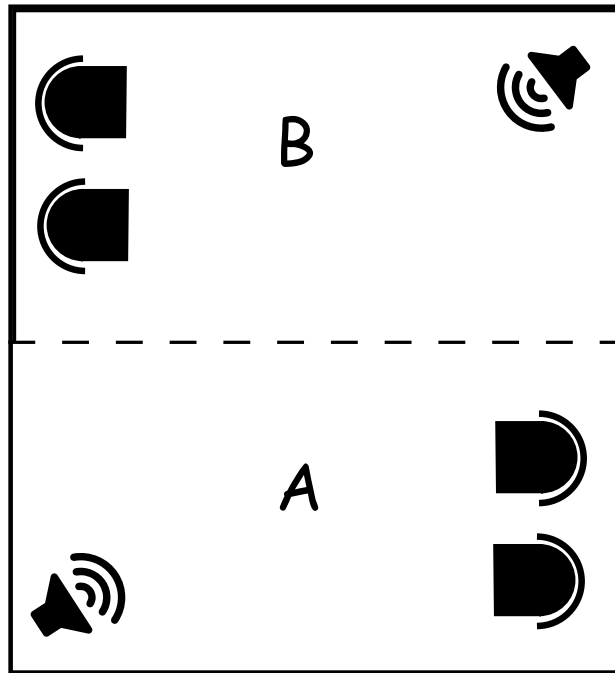

FIG. 5.1 The layout in the chambers.

Sound system

Each chamber was equipped with an ADAM A7X nearfield monitor connected to a Behringer U-Phoria UMC202HD audio-interface. The audio-interface was connected to a laptop from which the sound files were played through the software Audacity. The speakers were placed in a corner of the chamber having a distance of about 1.7 to 1.8 m from each of the chairs.

During the recording process, the words (see Appendix B) were read by a Dutch male speaker (age 38) in the acoustically treated chamber without any background sound and recorded with a Norsonic Nor 140 sound analyser that can also record and store a raw wave file. The wave files containing the words were then calibrated to have a SPL of a typical human voice at 1.8 m distance. There was about two seconds between words that belonged to the same question and 15 seconds between questions. Then these sound files were merged with calibrated sound files containing different background sounds at two different SPLs using the Adobe Audition software. In total, seven different background sound conditions were selected: 45 dB(A) or 60 dB(A) traffic noise, 45 dB(A) or 60 dB(A) classroom noise with children's talk, 45 dB(A) or 60 dB(A) piano music (a Bandari music named childhood memory), and silence (≈ 30 dB(A)). Each word-recording file was mixed with a 90 seconds episode of these background sounds.

Phonological processing task

The Phonological task that was performed in the experiments aimed to estimate children's hearing ability by only using spoken-words. It was similar as the 'odd one out' task used by Klatter [27], which contains four questions. In each question, three words, including two with similar pronunciation and one with different pronunciation were pronounced via a loudspeaker, and the children needed to pick up the different one. The children were not trained to do the tests but they were given instructions and one example to help them to understand the tests. All the words used in this test were CVC words (see Appendix B).

Daily procedure

At the beginning of the experiment, all children filled in a one-page personal information questionnaire, and then they were divided into groups of maximum 16 children. There was a maximum of three groups participating each experimental day. Every time only one group was further subdivided into four subgroups participating

in the experiments in the four test chambers (thermal, air, acoustics, and light). Thus, there was a maximum of four children as a subgroup participating in the acoustic experiment. Before the experiments, the instructor handed every child a one-page acoustic questionnaire, then carefully explained the procedure to the children and practiced with an example task. The experiment consisted of two similar sections, and it was performed in the two chambers simultaneously. During one section of the experiment, all the children performed a phonological processing task that was mentioned in the above paragraph, then reported their sound evaluation during the task by means of a five-point scale (very noise-noise-neutral-quiet-very quiet) and assessed the influence of the background sound on their performance by means of a three-point scale (bad influence-no influence-good influence). After section one, these children changed their seat to another chamber and repeated the same procedure with another background sound and/or level. Each section was three minutes in length. At the end of the experiment, they were asked to point out which chamber they liked better from an acoustics point of view and what the reason for that was.

Participants

In all, 335 children, including 167 girls and 168 boys from 10 classrooms of seven Dutch primary schools that were visited in the year before this study, participated in this study. The mean age of these children was 10.6 years old. Among them, 14 children reported having hearing problems; they were excluded from the analysis. Besides, the 27 children that participated in the first day were also excluded because of the use of a wrong questionnaire, and 4 children of school 4 were excluded because of sound speaker failure. After the filtering, the data of 290 children were left and were considered to be valid. Considering the fact that each child participated in the same test twice under two different experimental conditions, each child was regarded as two subjects. For these reasons, data of 580 cases were collected and used in this study. Their characteristics including age and gender were analysed under different conditions, as shown in Table 5.2, there's no statistically significant difference of these children among those conditions.

TABLE 5.2 Characteristics of children in different experiment conditions.

	45 dB (A) children talk	60 dB (A) children talk	45 dB (A) traffic	60 dB (A) traffic	45 dB (A) music	60 dB (A) music	No noise	P value
n	95	64	75	113	73	94	66	-
Age Mean (SD)	10.7 (1.0)	10.5 (1.0)	10.8 (1.0)	10.7 (1.1)	10.7 (1.1)	10.4 (1.1)	10.6 (1.1)	0.155 ^a
Gender (% Girls)	53.7	42.2	56.0	52.2	49.3	40.4	53.0	0.282 ^b

Notes: a. *p*-value obtained from ANOVA test; b. *p*-value obtained from Chi-squared test.

Ethical aspects

After recruitment of the schools, the parents received an information letter and a consent letter from the school management, which usually occurred two weeks before the visit. On the day of the visit, the research team received the consent forms usually from the teachers accompanying the children. For the children without permission to join the experiments, the school management generally decided not to have them join the visit. Furthermore, the children always had the option to opt out if they no longer wanted to participate.

The Ethics committee of the TU Delft gave approval for the study.

5.3.2 Data analysis

Descriptive analysis

Descriptive analysis was used to describe children's general information (including age, gender, hearing problems etc.), the mean value of scores of their tests, sound evaluations and influence assessments, and the comparison of their preferred chambers. For the analysis related to the test, sound evaluation and influence assessment, every child was regarded as two participants since each child participated twice in the experiment.

T-tests and Spearman's correlation tests

To check the learning effect, namely the influence of the sequence of tests on children's test scores, the Paired-Samples t-tests was used to compare children's scores between the first score and the second score. In terms of the evaluation of the effect of age and gender on children's performance, sound evaluation and influence assessment, the Independent-Samples t-test was used to compare children's responses between boys and girls (since there's no overlap of the participants in these two groups, they are independent from each other), and Spearman's correlation tests were applied to identify the relations between children's age and their responses. Additionally, this study tried to find the impact of children's sound perceptions in their real classrooms on the results got from the experiments. So, all the results were compared between children who were bothered by noise in their classrooms and children who were not by Independent-Samples t-test (because children in these two groups are different, they are independent from each other).

Two-way analysis of variance

Children's performance, sound evaluation and influence assessment were analysed with a two-way analysis of variance (ANOVA), with repeated measures on two factors: SPL with two levels (45 and 60 dB(A)) and sound type with three levels ('children talk', 'traffic' and 'music'). It should be noted that the test was conducted for the two chambers separately because every child participated in the experiment in both of the chambers. This means the participants in each chamber were the same, so the chamber could not be considered as another factor for the ANOVA. Differences between the levels of the within factors were examined by the comparison tests, and the effect of one factor was evaluated by holding the other factors fixed. If there was a statistically significant difference among the three levels of sound type, then three pairwise comparisons were conducted to compare each two levels.

5.4 Result

5.4.1 Performance test

Children's performance was evaluated by the phonological processing test scores; one score for each question. The t-test of the test score proved no significant effect of the test sequence ($t_{565,7} = -1.365$, $p = 0.173$), and no effect was shown ($r = 0.097$). The t-value measured the size of the difference relative to the variation in the sample data. The greater the t-value (either positive or negative), the greater the evidence that there was a significant difference. The average score for the first test was 2.92, while for the second test this was 3.03. In addition, the Spearman's correlation test showed no significant effect of age on the test score ($\rho = -0.015$, $p = 0.715$; ρ indicates the strength of the relation between these two variables, the greater the absolute value, the stronger the relations), which might be because the age range was narrow (8-13 years old). However, the scores differed significantly with respect to gender ($t_{552,4} = -3.493$, $p = 0.001$), and it represented a small effect ($r = 0.292$). In general, girls performed better (with an average score of 3.15) than boys (with an average score of 2.83).

5.4.2 Sound evaluation

The five-point scale (very noisy-noisy-neutral-quiet-very quiet) of the sound evaluation was coded into a score from 1 to 5 correspondingly in SPSS. The mean value was 2.85 ($SD = 1.11$). The noise evaluation approximately was normally distributed, with 38.5% of children voting for noisy (including very noisy), 34.4% of children voting for neutral, and 27.1% of children voting for quiet (including very quiet). According to the result of the Spearman correlation test and t-test, neither age ($\rho = -0.023$, $p = 0.582$) nor gender ($t_{552,8} = -0.130$, $p = 0.897$, $r = 0.009$) had a significant impact on children's sound evaluation.

5.4.3 Influence assessment

With regard to the assessment of influence of sounds on their school performance, the three-point scale (bad influence-no influence-good influence) was coded into a score from 1 to 3 in SPSS. The mean value of it was 1.87 ($SD = 0.75$). 35.4% of the children assessed the influence of sounds on their performance as bad, 41.9% of the children assessed it as “no influence”, and 22.7% assessed it as good. The assessment didn't differ significantly between boys and girls ($t_{543} = -0.331, p = 0.740, r = 0.027$), and it didn't have a relationship with age ($\rho = -0.080, p = 0.060$) based on the Spearman correlation test.

5.5 Discussion

The two-way ANOVA tests were conducted to examine the interaction of sound type and SPL on children's phonological processing performance, sound evaluation and assessment of the influence of sounds. Table 5.3 shows the main results of the tests. Only in the untreated chamber, the interaction between the impacts of SPL and sound type on children's phonological processing performance was statistically significant. The same was found for their influence assessment. Besides, the interaction between these impacts on children's sound evaluation tended to be significant for this chamber. The details of these results are discussed in this section.

TABLE 5.3 Results of the two-way ANOVA^a.

	Chamber A (untreated)			Chamber B (Acoustically treated)		
	SPL	Sound type	SPL* Sound type	SPL	Sound type	SPL* Sound type
Test scores	0.348	0.052	0.002	0.001	0.329	0.641
Sound evaluation	<0.001	<0.001	0.053	0.005	<0.001	0.253
Influence assessment	0.009	0.107	0.032	0.002	0.124	0.798

Notes: The *P* values are presented; *P*-values in bold mean statistically significant at the 5% level.

Comparing to the treated chamber A, there's no significant interaction between the sound type and SPL was found in the untreated chamber B, this might be caused by the difference between the nominal and the real SPLs of the sounds in chamber B. All the sound files were calibrated to have 45 dB(A) and 60 dB(A) in chamber A. At the seating position in chamber B, the same sound files actually sounded lower than in chamber A. According to the Sabine-Franklin-Jaeger's SPL equation, the difference of SPL between these two chambers was 12 dB(A). Therefore, at the seating position in chamber B, 45 dB(A) and 60 dB(A) were actually 33 dB(A) and 48 dB(A), respectively. This means that both of SPLs met the standard of the study room specified by BB93 [34], and these lower SPL sounds might be the reason that no significant interaction effect of SPL and sound types was found in this chamber.

5.5.1 Impact on children's performance

There was a statistically significant two-way interaction between the impacts of SPL and sound type on children's performance in chamber A, $F(2,280) = 6.278$, $p = 0.002$ (The F value is the ratio of two mean square values. A large F (either positive or negative) value means the null hypothesis is wrong, or in other words, the data are not sampled from populations with the same mean; The P value is determined from the F value). The means of children's test scores for the six conditions (two SPL \times three sound types) in chamber A are plotted in the left part of Figure 5.2. However, there was no statistically significant two-way interaction between SPL and sound type in chamber B, with respect to the impact on children's performance. The means of children's test scores in chamber B are plotted in the right part of Figure 5.2.

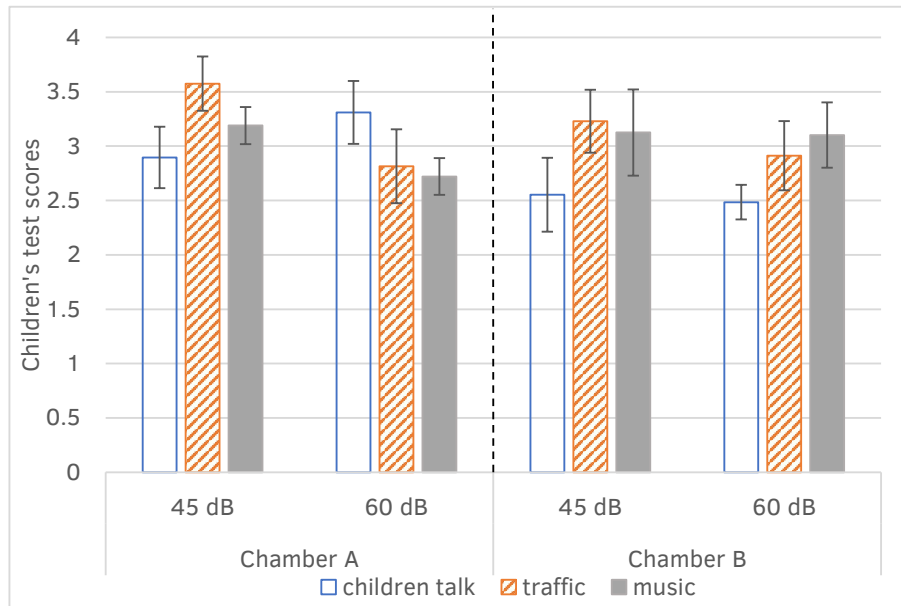

FIG. 5.2 Mean values of children's test scores in different experimental conditions for chamber A and B.¹

¹ Error bars that represent the 95% confidence interval (CI) of the mean values were added in Figure 5.2 of the published version.

In chamber A, a statistically significant difference of children's test scores between different sound types was found ($F(2, 280) = 4.318, p = 0.014$) for a SPL of 45 dB(A). When the sound was 'children talk' the mean value of children's test score was the lowest. When the sound was 'traffic' their average score increased significantly ($p = 0.004$). No other significant difference was found for the other two pairwise comparisons. When the SPL was 60 dB(A), no statistically significant difference of children's test scores was seen among these three types. When comparing the SPL situation of 60 dB(A) with 45 dB(A), no statistically significant difference of children's test scores was seen during the 'children talk' sound, but when 'traffic' sound was played, their test score was significantly higher in the 45 dB(A) situation, ($F(1, 280) = 11.388, p = 0.001$) and when 'music' sound was played, their test score showed a tendency to increase in the 45 dB(A) situation ($F(1, 280) = 3.740, p = 0.054$).

In chamber B, children's test scores differed significantly among different sound types in both SPL situations (45dB, $F(2, 276) = 4.724, p = 0.010$; 60dB, $F(2, 276) = 3.275, p = 0.039$). When the SPL was 45 dB(A), children's test score significantly increased during both the 'traffic' sound ($p = 0.005$) and the 'music' sound ($p = 0.022$) compared with the 'children talk' sound. In the situations with 60 dB(A) sounds, children's test score was significantly higher during the 'music' than the 'children talk' sound ($p = 0.012$), but no statistically difference of children's scores was found in the other two pairwise comparisons. There was no statistically significant difference of children's test score between 45 dB(A) and 60 dB(A) situations with any sound types. This could be explained by the fact that the SPL of sounds at the seating position in chamber B was 12 dB(A) lower their nominal values and the SPL of those sound files met the standards.

5.5.2 Impact on children's sound evaluation

There was a strong tendency for the interaction between the impacts of SPL and sound type on children's sound evaluation in chamber A ($F(2, 271) = 2.975$, $p = 0.053$). However, no statistically significant interaction between SPL and sound type on children's sound evaluation was found in chamber B. The means of children's sound evaluations in the six conditions in each of these two chambers are plotted in Figure 5.3.

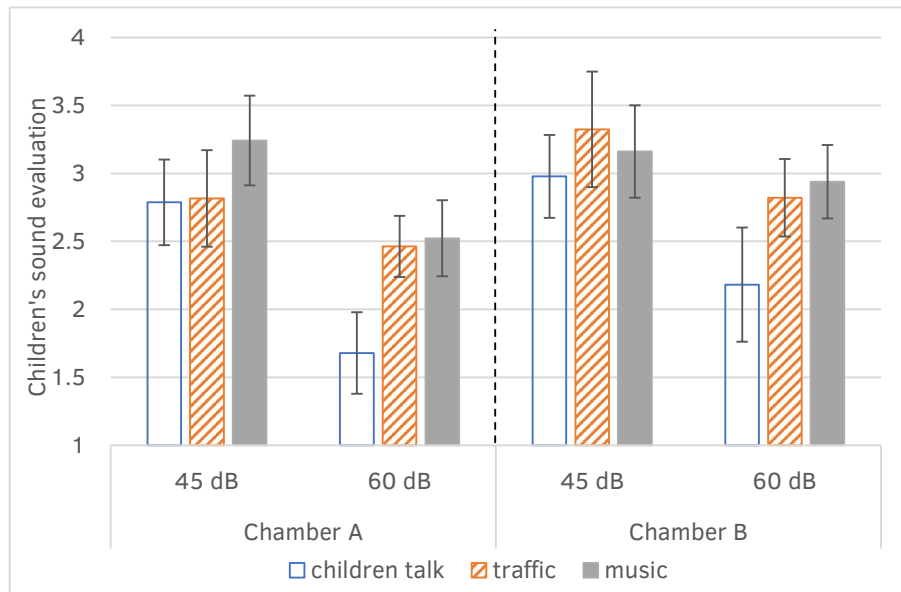

FIG. 5.3 Mean values of children's evaluations of sound in different experimental conditions for chamber A and B.²

In chamber A, no statistically significant difference of children's evaluation of sound was seen with an SPL of 45 dB(A). While with an SPL of 60 dB(A), a significant difference was found among the three sound types ($F(2, 271) = 7.626$, $p = 0.001$). However, only one significant pairwise difference was found between the situations with the 'children talk' sound and the 'music' ($p = 0.040$). Compared with 60 dB(A),

² Error bars that represent the 95% confidence interval (CI) of the mean values were added in Figure 5.3 of the published version.

children's evaluation scores of sounds were significantly higher (quieter) in the 45 dB(A) situations with the 'children talk' sound ($F(1, 271) = 22.815, p < 0.001$) or the 'music' ($F(1, 271) = 10.332, p = 0.001$), while no significant difference of children's evaluation was seen between 45 dB(A) and 60 dB(A) 'traffic' sounds.

In chamber B, still no statistically significant difference of children's evaluations of sounds was seen when the SPL was 45 dB(A), while a significant difference was found among the three sound types ($F(2, 268) = 5.504, p = 0.005$) when the SPL was 60 dB(A). Compared with the 'children talk' sound, children's evaluation scores for the 'traffic' sound ($p = 0.007$) and the 'music' sound ($p = 0.002$) were significantly higher. But there was no significant difference of children's evaluations between the 'traffic' sound and 'music'. For the comparison of children's evaluations of sounds between two SPLs, children evaluated the 45 dB(A) sounds significantly higher. This difference was statistically significant for the 'children talk' ($F(1, 268) = 10.650, p = 0.001$) and 'traffic' sound ($F(1, 268) = 4.709, p = 0.031$).

5.5.3 Impact on children's influence assessment

There was a statistically significant two-way interaction between the impacts of SPL and sound type on children's influence assessments in chamber A ($F(2, 265) = 3.495, p = 0.032$). The means of children's assessment in the six conditions in chamber A are plotted in the left part of Figure 5.4. No statistically significant two-way interaction among SPL and sound type in chamber B was found. The means of children's assessments in chamber B are plotted in the right part of Figure 5.4.

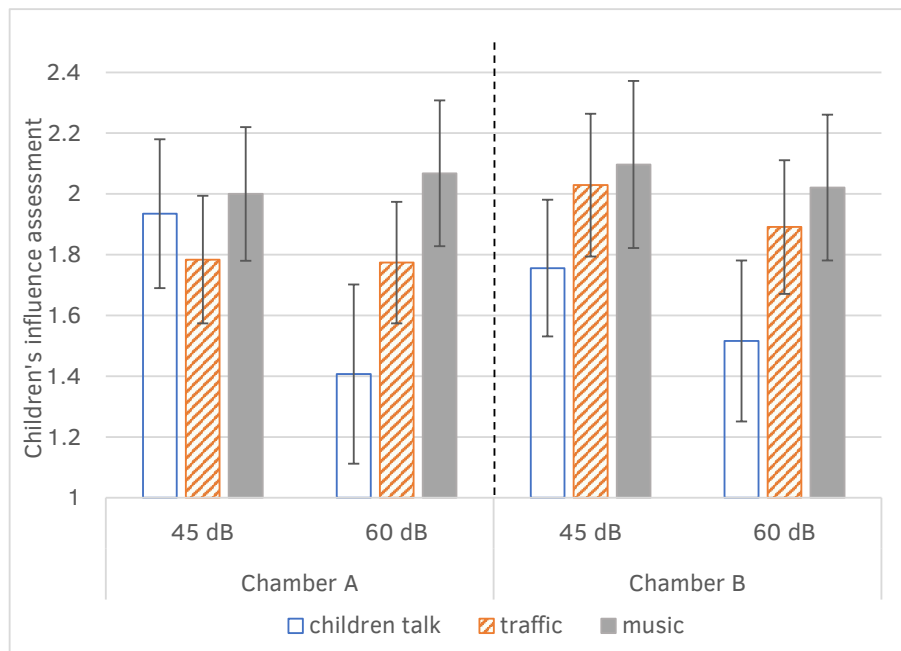

FIG. 5.4 Mean values of children's influence assessment in different experimental conditions for chamber A and B.³

In chamber A, with an SPL of 45 dB(A), no statistically significant difference of children's assessment of influence of sounds was seen between the three sound types, while when the SPL was 60 dB(A), there was a significant difference

³ Error bars that represent the 95% confidence interval (CI) of the mean values were added in Figure 5.4 of the published version.

($F(2, 265) = 6.886, p = 0.001$). The differences between each two sound types were also found to be significant: children thought the influence of the 'children talk' sound was the most negative, the 'traffic' sound was significantly better than the 'children talk' sound ($p = 0.035$), and the 'music' was significantly better than both the 'children talk' sound ($p < 0.001$) and the 'traffic' sound ($p = 0.049$). According to the results of the comparison of children's influence assessment between 45 dB(A) and 60 dB(A), only when the sound type was 'children talk' a significant difference of children's assessment scores of the influence of sounds was found ($F(1, 265) = 8.851, p = 0.003$).

In chamber B, when the SPL was 45 dB(A), still no statistically significant difference of children's assessments of the influence of sounds was seen among the three sound types. However, when the SPL was 60 dB(A), a significant difference was found ($F(2, 264) = 4.429, p = 0.013$): compared with the 'children talk' sound, children's assessment scores of the influence of the 'traffic' sound ($p = 0.026$) or the 'music' ($p = 0.004$) were significantly higher, but there was no significant difference between the 'traffic' sound and the 'music'. The comparison between 45 dB(A) and 60 dB(A) didn't show any significant difference of children's assessment of the influence of sounds, no matter what sound type it was. This might be due to the fact that the SPLs in Chamber B were lower than chamber A. In fact, both SPLs in chamber B met the standard of a classroom. So, they might not have had the negative influence on children's performance as was intended.

5.5.4 Relation to children's real classrooms

In the year before this study, a field study was conducted in the schools that the children participating came from. That study showed that 87% of children were bothered by noise in their classrooms [2]. Among the children who participated in this study, 220 children participated in the previous field study, and 90% (195) of these 220 children reported to be bothered by noise in their classrooms. To find out whether this previous assessment has an impact on children's response in this study, t-tests were conducted to compare the children who were bothered by noise in their classrooms and the children who were not. As shown in Table 5.4, there were statistically significant differences in children's test scores and influence assessment between these two groups of children, and both of them present small effects. Children who were bothered by the noise in their classroom got higher test scores, but evaluated lower on the influence assessment than children who were not bothered.

On one hand, this might be explained through some children's acute hearing. The previous field study showed that different children can have different concerns in terms of the factors of IEQ, and some children were more concerned about sound in their classrooms [35]. It is hypothesized that these children were prone to be bothered by noise, but at the same time, they could have a better performance in the phonological processing because of their acute hearing. On the other hand, it also might be explained through children's different intelligence. According to a publication of Psyke 59 Grader Nord, children with high intelligence are usually more sensitive to outside stimuli including sound, smell and taste [36]. Therefore, these gifted children could have a better performance in the test, but they might also be more easily distracted by irrelevant sounds. Most of these hypotheses need to be tested in the future.

TABLE 5.4 Comparison between children who were bothered by noise in their classrooms and children who were not.

Bothered by noise	Yes (Mean)	No (Mean)	t ^a	P-values ^b	Effect size
Test scores	3.06 (1.08)	2.70 (1.13)	$t_{432} = 2.075$	0.039	0.330
Sound evaluation	2.83 (1.10)	2.79 (1.01)	$t_{419} = 0.244$	0.808	0.037
Influence assessment	1.79 (0.74)	2.05 (0.72)	$t_{411} = -2.117$	0.035	0.352

Notes: a. The t-value obtained from t-tests, measured the size of the difference relative to the variation in the sample data. The greater the t-value (either positive or negative), the greater the evidence that there is a significant difference. / b. P-values obtained from t-tests. P-values in bold mean statistically significant at the 5% level.

5.5.5 Limitations

With respect to the limitations of this study, two main weaknesses should be mentioned. One is the setting of the experimental chambers, the small size and the thick curtain causing a low RT in the chambers, even for the untreated chamber. Both reached the highest class of the acoustic requirements for primary schools in the Netherlands. Future studies would better be conducted in real classrooms or in rooms with similar size and similar acoustic conditions as real classrooms.

The second limitation is the single performance task. Previous studies have demonstrated many different tasks. However, due to the limitations of time (pupils had to undergo many different tests also on other indoor environmental factors), only one phonological processing task was used in this study. So, the impact on children's other performance still needs to be evaluated. Future studies should adopt more tasks to conduct a full assessment of children's performance.

5.6 Conclusion

The current study provides evidence for the impact of acoustic conditions on children. In addition to the review of the well-documented influences of different types of sounds on children's performance, this study reported the interaction between sound type and SPL on children's performance, sound evaluation and influence assessment. Statistically significant interactions between the impact of SPL and sound type on children's phonological processing performance and assessment of the influence of sounds were demonstrated in the untreated chamber (whose RT interestingly got close to a class A classroom in the Netherlands according to the Requirement of Fresh Schools [37]). In this chamber, the simple main effects analysis showed that children performed better under the 45 dB(A) conditions than the 60 dB(A) conditions when the sound type was 'traffic', and children evaluated the 45 dB(A) sound to have a better influence than the 60 dB(A) sound when the sound type was 'children talk'. Additionally, a significant effect of sound type on children's performance was found when the SPL was 45 dB (A), and on children's influence assessment when the SPL was 60 dB (A).

Although this study was conducted in a lab environment and all the background sounds were played through a speaker, its findings still have practical significance, especially the one that showed the interaction effect of the sound type and SPL on children. Additionally, the study showed that the two-way ANOVA analysis method could be an appropriate method to test the interaction between two characteristics of a sound.

Acknowledgements

This study was sponsored by the fellowship of Philomena Bluysen provided by the Delft University of Technology under the chair of Indoor Environment and the China Scholarship Council (CSC).

References

- [1] Shield, B.M. and J.E. Dockrell, The effects of noise on children at school: a review. *Building Acoustics*, 2003. 10(2): p. 97-116.
- [2] Bluysen, P.M., D. Zhang, S. Kurvers, M. Overtoom, and M. Ortiz-Sanchez, Self-reported health and comfort of school children in 54 classrooms of 21 Dutch school buildings. *Building and Environment*, 2018. 138: p. 106-123.
- [3] Elliott, E.M., The irrelevant-speech effect and children: Theoretical implications of developmental change. *Memory & Cognition*, 2002. 30(3): p. 478-487.
- [4] Schlittmeier, S.J. and J. Hellbrück, Background music as noise abatement in open-plan offices: A laboratory study on performance effects and subjective preferences. *Applied Cognitive Psychology: The Official Journal of the Society for Applied Research in Memory and Cognition*, 2009. 23(5): p. 684-697.
- [5] Cassidy, G. and R.A. MacDonald, The effect of background music and background noise on the task performance of introverts and extraverts. *Psychology of Music*, 2007. 35(3): p. 517-537.
- [6] Dobbs, S., A. Furnham, and A. McClelland, The effect of background music and noise on the cognitive test performance of introverts and extraverts. *Applied cognitive psychology*, 2011. 25(2): p. 307-313.
- [7] Bluysen, P.M., D. Zhang, A.M. Eijkelenboom, and M. Ortiz-Sanchez, First SenseLab studies with primary school children: exposure to different environmental configurations in the Experience room. *Intelligent Buildings International*, 2019: DOI: 10.1080/17508975.2019.1661220.
- [8] Bluysen, P.M., F. van Zeist, S. Kurvers, M. Tenpierik, S. Pont, B. Wolters, L. van Hulst, and D. Meertins, The creation of SenseLab: a laboratory for testing and experiencing single and combinations of indoor environmental conditions. *Intelligent Buildings International*, 2018. 10 (1): p.5-18.
- [9] Shield, B.M. and J.E. Dockrell, The effects of environmental and classroom noise on the academic attainments of primary school children. *The Journal of the Acoustical Society of America*, 2008. 123(1): p. 133-144.
- [10] Hygge, S., Classroom experiments on the effects of different noise sources and sound levels on long-term recall and recognition in children. *Applied Cognitive Psychology*, 2003. 17(8): p. 895-914.
- [11] Stansfeld, S.A., B. Berglund, C. Clark, I. Lopez-Barrio, P. Fischer, E. Öhrström, M.M. Haines, J. Head, S. Hygge, and I. Van Kamp, Aircraft and road traffic noise and children's cognition and health: a cross-national study. *The Lancet*, 2005. 365(9475): p. 1942-1949.
- [12] Söderlund, G., S. Sikström, and A. Smart, Listen to the noise: noise is beneficial for cognitive performance in ADHD. *Journal of Child Psychology and Psychiatry*, 2007. 48(8): p. 840-847.
- [13] Shield, B.M. and J.E. Dockrell, External and internal noise surveys of London primary schools. *The Journal of the Acoustical Society of America*, 2004. 115(2): p. 730-738.
- [14] Shield, B.M. and J.E. Dockrell, Acoustical barriers in classrooms: the impact of noise on performance in the classroom. *British Educational Research Journal*, 2006. 32: p. 17.
- [15] North, A.C., D.J. Hargreaves, and S.A. O'Neill, The importance of music to adolescents. *British Journal of Educational Psychology*, 2000. 70(2): p. 255-272.
- [16] Hall, J.C., The effect of background music on the reading comprehension of 278 eighth and ninth grade students. *The Journal of Educational Research*, 1952. 45(6): p. 451-458.
- [17] Mitchell, A.H., The effect of radio programs on silent reading achievement of ninety-one sixth grade students. *The Journal of Educational Research*, 1949. 42(6): p. 460-470.
- [18] Burleson, S.J., D.B. Center, and H. Reeves, The effect of background music on task performance in psychotic children. *Journal of Music Therapy*, 1989. 26(4): p. 198-205.

- [19] Fitzpatrick, F., The use of rhythm in training severely subnormal patients. *American journal of mental deficiency*, 1959. 63(6): p. 981-987.
- [20] Richman, J.S., Background music for repetitive task performance of severely retarded individuals. *American Journal of Mental Deficiency*, 1976.
- [21] Hallam, S., J. Price, and G. Katsarou, The effects of background music on primary school pupils' task performance. *Educational studies*, 2002. 28(2): p. 111-122.
- [22] Konecni, V., Social interaction and musical preference, *The psychology of music*, 1982: p. 475-561. Academic Press.
- [23] North, A.C. and D.J. Hargreaves, Music and consumer behaviour. *Oxford handbook of music psychology*, 2009: p. 481-490.
- [24] Furnham, A., S. Trew, and I. Sneade, The distracting effects of vocal and instrumental music on the cognitive test performance of introverts and extraverts. *Personality and Individual Differences*, 1999. 27(2): p. 381-392.
- [25] Iwanaga, M. and T. Ito, Disturbance effect of music on processing of verbal and spatial memories. *Perceptual and motor skills*, 2002. 94(3_suppl): p. 1251-1258.
- [26] Smith, W., Effects of industrial music in a work situation requiring complex mental activity. *Psychological Reports*, 1961. 8(1): p. 159-162.
- [27] Klatte, M., J. Hellbrück, J. Seidel, and P. Leistner, Effects of classroom acoustics on performance and well-being in elementary school children: A field study. *Environment and Behavior*, 2010. 42(5): p. 659-692.
- [28] de Graaff, S., F. Hasselman, L. Verhoeven, and A.M. Bosman, Phonemic awareness in Dutch kindergartners: Effects of task, phoneme position, and phoneme class. *Learning and Instruction*, 2011. 21(1): p. 163-173.
- [29] Bradley, L. and P.E. Bryant, Categorizing sounds and learning to read—a causal connection. *Nature*, 1983. 301(5899): p. 419.
- [30] Clark, C., R. Martin, E. Van Kempen, T. Alfred, J. Head, H.W. Davies, M.M. Haines, I.L. Barrio, M. Matheson, and S.A. Stansfeld, Exposure-effect relations between aircraft and road traffic noise exposure at school and reading comprehension: the RANCH project. *American journal of epidemiology*, 2005. 163(1): p. 27-37.
- [31] Ljung, R., P. Sorqvist, and S. Hygge, Effects of road traffic noise and irrelevant speech on children's reading and mathematical performance. *Noise and Health*, 2009. 11(45): p. 194.
- [32] Klatte, M., T. Lachmann, and M. Meis, Effects of noise and reverberation on speech perception and listening comprehension of children and adults in a classroom-like setting. *Noise and Health*, 2010. 12(49): p. 270.
- [33] Zhang, D., M. Tenpierik, and P.M. Bluysen, The effect of acoustical treatment on primary school children's performance, sound perception, and influence assessment, in *E3S Web of Conferences, vol. 111. EDP Sciences*, 2019.
- [34] Department of Education, Building bulletin 93, Acoustic design of schools: Performance standards. 2015, The National Archives London.
- [35] Zhang, D., M.A. Ortiz, and P.M. Bluysen, Clustering of Dutch school children based on their preferences and needs of the IEQ in classrooms. *Building and environment*, 2019. 147: p. 258-266.
- [36] Psyke 59 Grader Nord. High intelligence combined with High sensitivity. 2018 [cited 2018 23 Oct]; Available from: <http://psyke59gradernord.com/english/9-high-intelligence/4-high-intelligence-combined-with-high-sensitivity>.
- [37] The Netherlands Enterprise Agency, Programma Van Eisen Frisse Scholen 2015. 2015.

Appendix 5.A

The list of studies that used performance tasks.

Type of tasks	Reference	Detail task	Main finding
Phonological processing	Klatte, 2010 [27]	Chose the different word from the others with respect to the initial or the final sound.	Children performed better in the classrooms with a short RT.
Spelling	Shield, 2006 [14]	The English spelling test: 15 age-appropriate items spelling test.	Compared with typical quiet classrooms, children performed better in the classrooms with babble and environmental noise, but worse in the classrooms only with babble.
	Klatte, 2010 [27]	The German spelling test: write down single words and sentences, the score is the number of correctly written graphemes.	There was no significant impact of the RT on children's spelling performance.
Reading	Shield, 2006 [14]	Reading test: Suffolk Reading Scale, A standardised reading test that consists of multiple-choice and sentence-completion questions.	Compared with typical quiet classrooms, children performed better in the classrooms with babble and environmental noise, but worse in the classrooms only with babble.
	Clark, 2005 [30]	Reading comprehension tests: nationally standardized tests were used (suitable for 8-13 years old children). In the UK, the 86-item Suffolk Reading Scale, level 2 was used; in the Netherlands, the 43-item CITO Readability Index for Elementary and Special Education was used; in Spain, the 27-item ECL-2 was used.	Aircraft noise had a detrimental effect on children's reading comprehension. This negative relation between aircraft noise exposure and children's reading comprehension were found in all three countries.
	Ljung, 2009 [31]	Reading speed and comprehension test: fill the intervals in a four-page story, in each interval, choose the appropriate word from three options.	With regard to reading speed, children performed slower in the traffic noise condition than in the silent or in the irrelevant speech conditions. Regarding reading comprehension, no significant effect of noise was found.
Memory	Cassidy, 2007 [5]	Immediate recall task: recall a short news story containing 21 'ideas'. Free recall task: recall 20 everyday six-letter words. Delayed recall task: recall the passage in the first immediate recall task.	Students performed worse on all tasks while listening to background sound, no matter whether it was music or noise.

>>>

The list of studies that used performance tasks.

Type of tasks	Reference	Detail task	Main finding
Mathematic	Shield, 2006 [14]	Arithmetic: basic computation without verbal component.	Children performed better in typical quiet classrooms than in classrooms with noise generated by children.
	Ljung, 2009 [31]	Arithmetic: three division problems and three multiplication problems. Geometric: name points in a coordinate system. Understand the relationship between fractional expressions and areas of figures. Understand the relationship between distance and numerical expressions; measure distances.	Compared with silence, road traffic noise had a negative influence on children's mathematical performance.
Listening comprehension	Klatte, 2010 [32]	Listening comprehension task: mark the appropriate drawings based on the listening instruction.	Both background speech and classroom noise had a negative impact on children's listening comprehension, the younger the children the more vulnerable.

Appendix 5.B

The list of words used in the phonological processing task.

1	kop	kup	fos
2	sif	num	nom
3	lir	ler	nim
4	rol	nem	rul
5	pok	men	min
6	pik	lor	pek
7	sof	suf	weg
8	fis	van	fes

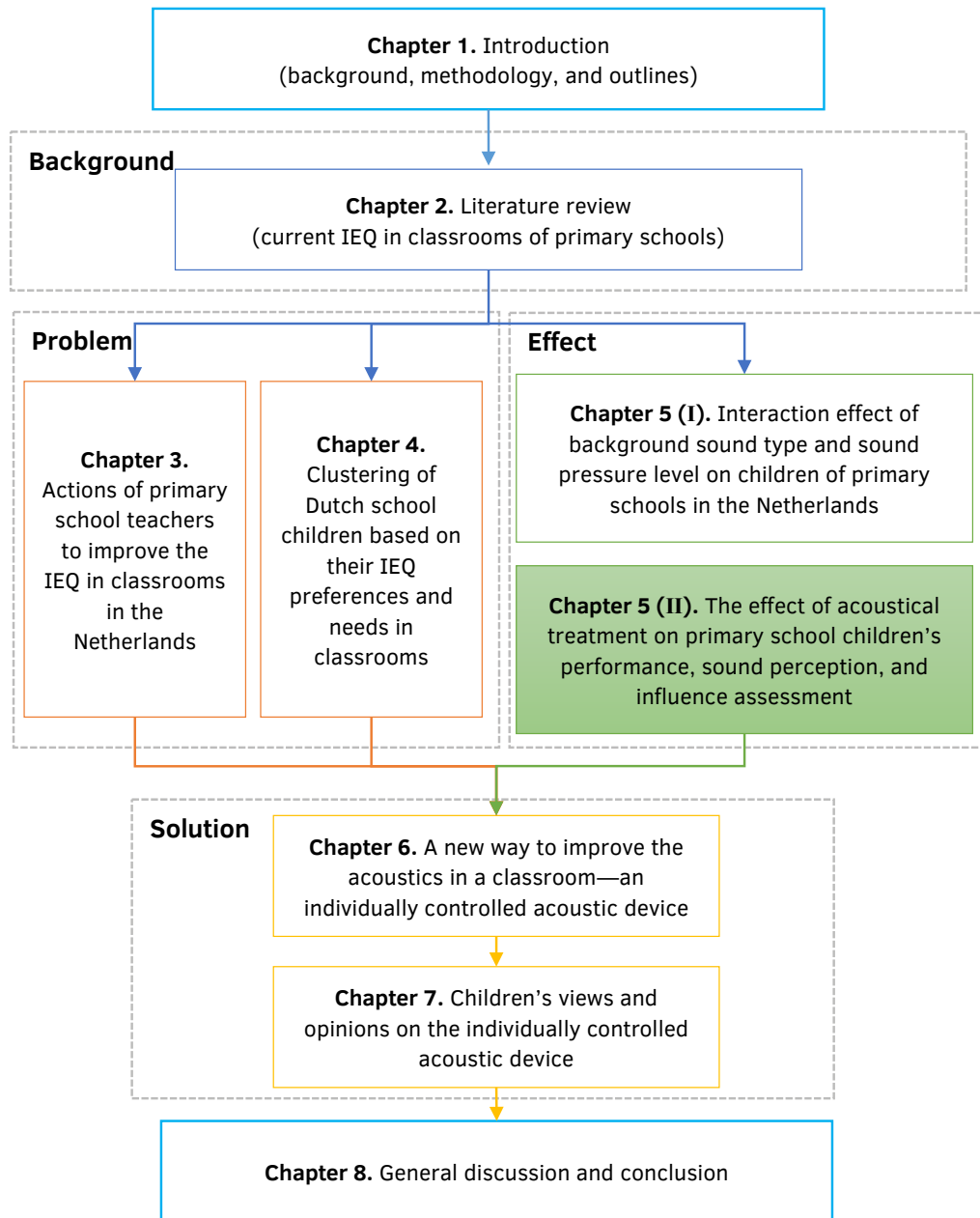

Part II / The effect of acoustical treatment on primary school children's performance, sound perception, and influence assessment

ABSTRACT A previous field study showed that more than 85% of Dutch children reported they were bothered by noise in the classroom. To investigate the impact of acoustical treatment on children's phoneme identification, 335 school children (9 to 13 years old) from the previously studied schools were invited to take part in a series of tests in the acoustical chamber of the SenseLab. All the children performed two series of listening tests and evaluations in chamber A (untreated) and chamber B (acoustically treated) respectively, while at the same time one of seven background sounds (45dB or 60dB traffic noise, 45dB or 60dB children talking, 45dB or 60dB music, or no sound) were randomly played in the chambers. T-tests were conducted to compare the results of children's phonological process tasks, sound perceptions, and influence assessments in these two chambers. Results showed a statistically significant difference in children's sound perceptions ($p=0.01$). Children reported the untreated chamber A to be noisier.

5.7 Introduction

Over the past decades, the acoustical condition of classrooms has arisen much attention because of its important role in school children's comfort and performance. Several previous studies indicated that children are much more impaired than adults by noise and exposure to noise may impair children's performance [1]. Results of a previous field study conducted by Bluysen et al. [2] showed that noise was the main annoyance for children in classrooms in the Netherlands. 98% of children could hear noise in their classroom and 87% of children reported to be bothered by the

noise. Such an unfavourable learning environment might have a negative impact on children's comfort, performance and health [3, 4]. Therefore, improvement of the acoustics in classrooms is an important topic to consider for research.

Reverberation time (RT), as one of the major parameters to measure the acoustics, is often used in guidelines, such as the Requirement of Fresh Schools in the Netherlands and the Building Bullentin 93 in the UK. Many studies have found that a longer RT could impair children's performance [3] [5], especially for children who have a hearing problem [6] and who are not native speakers [7].

Several ways to improve the RT in classrooms have been studied before, for example using acoustical ceiling tiles [8] or fleecy floor coverings (carpets) [9]. All of them have been proved to be effective to reduce the potential noise perception in a classroom. However, only few studies investigated children's response to these or other forms of acoustical treatment.

Therefore, to examine the effect of acoustical treatment of a room on children, this study was carried out. 335 primary school children were invited to participate in two series of experiments in the acoustical chamber of the SenseLab, which was divided into an acoustically treated and an untreated part [10]. In these two chambers, children were asked to perform two series of tasks and evaluations, while one of seven background sounds (45 dB(A) or 60 dB(A) children talk, 45 dB(A) or 60 dB(A) traffic, 45 dB(A) or 60 dB(A) music, or no sound (≈ 30 dB(A))) was randomly playing. This current paper shows the result of the comparison of children's performance, sound perceptions, and the influence assessment between these two chambers. The effect of sound type and sound pressure level on children will be reported elsewhere.

5.8 Methodology

5.8.1 Study design

This study was part of a series of tests performed in the SenseLab [9], with 335 children from seven primary schools that took place on 10 different days between February 13 and April 5, 2018 [10].

5.8.2 Facilities



FIG. 5.5 The set-up in one of the chambers.

The study reported here was conducted in the acoustical chamber of the SenseLab (width 2.4 m, length 2.6 m, height 2.1 m). The chamber was equally divided into two parts (or two chambers) by a thick curtain. One of them did not have any acoustical treatment, so it was called the untreated chamber A, while in the other one acoustical absorption panels were attached to the three walls and ceiling by magnets, and was named the acoustically treated chamber B. The estimated RTs of these two chambers were 0.33 and 0.07 seconds, respectively (average from 250 to 2000 Hz). In each chamber, there was a speaker placed in a corner and two chairs placed on the opposite side (see Figure 5.5). Both of the speakers in these chambers were controlled through a laptop and played the same sound files at the same time.

5.8.3 Performance task

To test performance, a phonological processing task, aimed to evaluate children's hearing ability, was used. In each of the questions, three consonant-vowel-consonant Dutch words, including two with similar pronunciation and one with different pronunciation (e.g. cop, cup, fos), were played together with the background sounds via the speakers. Children were asked to select the [38] one with the different pronunciation and to mark the corresponding answer on the questionnaire (see Figure 5.6). Before the test, all the words were spoken by a 38 years old Dutch male and recorded by a sound analyser (type Norsonic Nor 140), were merged with seven different background sounds respectively, using Adobe Audition software, and were calibrated in the chamber to get the correct sound pressure levels.

5.8.4 Procedure

On the day of the study, all the children first filled in a one-page personal information questionnaire, and then were divided into groups with maximum 16 children. On each experimental day, two or three groups participated. During the series of tests in the test chambers, the participating group was further divided into four subgroups and started each in one of the four test chambers of the SenseLab (the thermal, air, light and acoustics test chamber). After 7-8 minutes, the groups moved on to the next test chamber, until they had visited all of the test chambers. Before the children entered the acoustics chamber, an instructor carefully explained the procedure of the acoustic test to them, and demonstrated how to answer the questions with an example task, and then handed them a one-page questionnaire (see Fig. 2).

The acoustic test consisted of two parts, of which each comprised of four phonological processing questions, one sound perception evaluation with a five-point scale and one influence assessment with a three-point scale (see Fig. 2). Children in both parts of the chamber (A and B), started the test at the same time. After the first part, they changed positions to the other part of the chamber and repeated the test. Each had a duration of three minutes. After the second time, children were asked to answer one more question: "Which chamber do you like better? And why?"

Acoustics

School name: _____ Group: _____
Person ID: _____ Date: _____

Chamber

1- Listen to the pronunciation of three words; two of them have the same sound, one is different. Please mark the different one.

1 A B C

2 A B C

3 A B C

4 A B C

2- What do you think of the background noise?

very quiet quiet neutral noisy very noisy

3- What do you think of the influence of the background noise on your preference?

good influence no influence bad influence

Extra question

1- Which chamber do you like better? and why?

Chamber A Chamber B Because: _____

2- Hoe denk je dat achtergrondgeluid jouw schoolprestaties beïnvloedt?

goede invloed geen invloed slechte invloed

FIG. 5.6 Excerpt from acoustical chamber questionnaire for the listening task.

5.8.5 Data management and analysis

All the data were manually typed in and stored in IBM SPSS Statistics 24.0. For the performance tasks, one point was given for each correct answer. The total scores of each child for both tests (in Chamber A and B) were calculated. For the sound perception, the five-point scale (very noisy-noisy-neutral-quiet-very quiet) was coded into a score from 1 to 5 correspondingly. Similarly, for the influence assessment, the three-point scale (bad influence-no influence-good influence) was coded into a score from 1 to 3.

Descriptive analysis was used to show children's personal information (e.g. age, gender etc.), and the general result of children's performance tasks, sound perceptions, and their influence assessments. In all of the analyses, except for their personal information, every child was regarded as two subjects, each one corresponding to one part of the test.

In addition, comparative analysis was also conducted to evaluate the effect of the acoustical treatment, by means of the independent-samples t-test. Results of children's performance tasks, sound perceptions, and their influence assessments were all compared between these two chambers A and B.

5.8.6 Ethical aspects

The parents of the children that participated, received and signed a consent form before the experimental day. All the forms were collected on the experimental day. Only the children whose parents agreed on their participation took part in the series of tests. The ethics committee of the TU Delft gave approval for the study.

5.9 Results

5.9.1 Participants

In all, 335 children including 167 girls and 168 boys participated. Among them, 14 children reported having hearing problems, 27 children of the first day used the wrong version of the questionnaire, and four children of the sixth day skipped one part because of speaker failure. All of them were excluded from the analysis. After the filtering, 290 children, including 145 girls and 145 boys, with an average age of 10.6 years (SD of 1.1 years), were left.

Performance test

According to the result of the t-tests, there was no statistically significant difference of children's test scores between Chambers A and B ($p=0.29$). The mean value was 3.0 in chamber A and 2.9 in chamber B (see Table 5.5). As shown in Figure 5.7, the percentage of children who got the full score were higher in the chamber A than in chamber B, while for the other scores, the percentage of children for those scores were almost same for the two chambers.

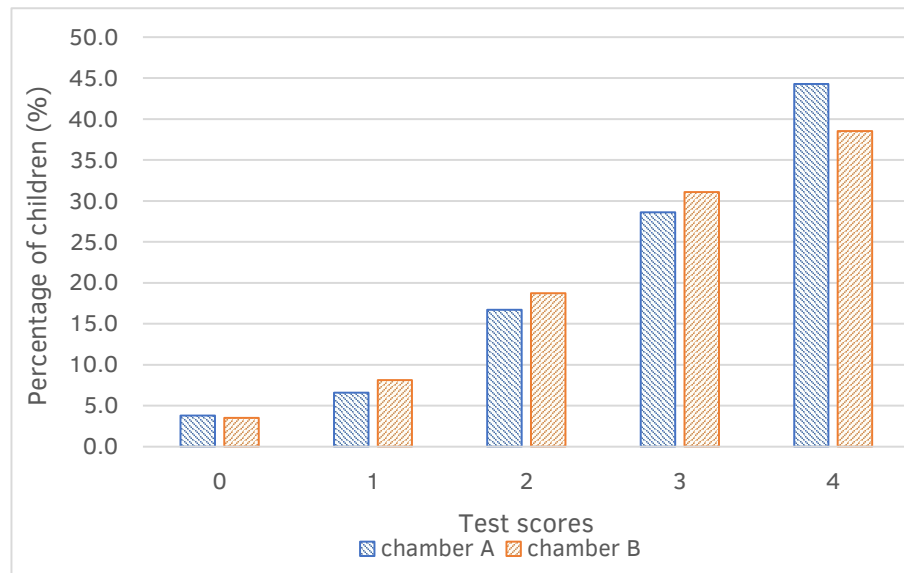

FIG. 5.7 The distribution of children's test scores.

Sound perception

According to the result of the t-tests, there was a statistically significant difference of children's sound perceptions between the two chambers ($p<0.05$). Children evaluated chamber A to be noisier (mean=2.7) than chamber B (mean=3.0) (see Table 5.5). As shown in Figure 5.8, the percentages of children that selected 'very

'noisy' and 'noisy' were higher in chamber A than in chamber B, while for the 'neutral', 'quiet' and 'very quiet', the percentage of children was higher in chamber B than in chamber A.

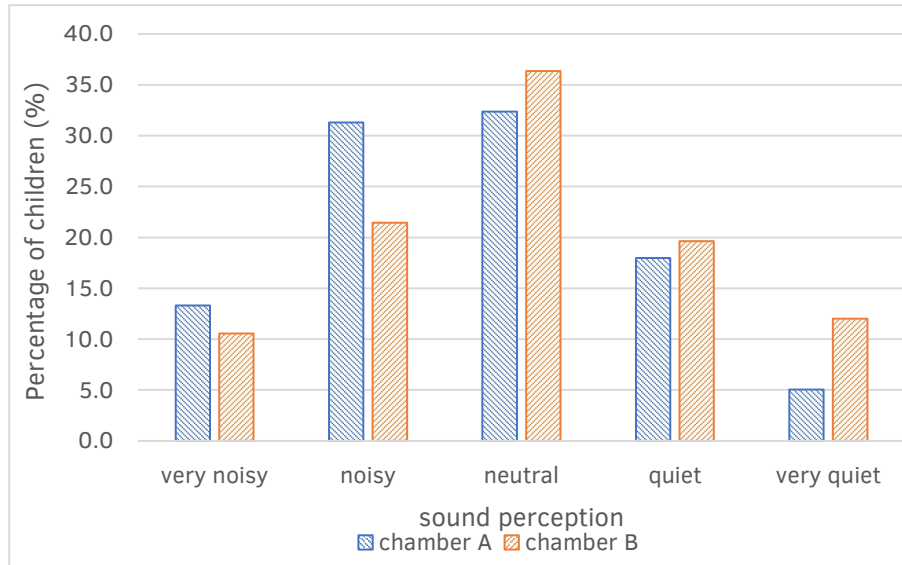

FIG. 5.8 The distribution of children's sound perceptions.

Influence assessment

With respect to the assessment of influence, there was no statistically significant difference of children's answers between the two chambers ($p=0.78$). The mean value of children's influence assessment in these chambers were almost identical: 1.87 for chamber A and 1.89 for chamber B (see Table 5.5). The distributions of children's answers (Figure 5.9), were also almost identical.

TABLE 5.5 Comparison of children's test scores and evaluation scores between Chamber A and B.

	Chamber A	Chamber B	t ^a	P-values ^b
Test scores	3.03 (1.11)	2.93 (1.10)	$t_{568} = 1.065$	0.287
Sound perception	2.70 (1.07)	3.01 (1.15)	$t_{551} = -3.282$	0.001
Assessment of the influence of sounds	1.87 (0.75)	1.89 (0.76)	$t_{541} = -0.278$	0.781

Notes: a. The t-value obtained from t-tests, measured the size of the difference relative to the variation in the sample data. The greater the t-value (either positive or negative), the greater the evidence that there is a significant difference. / b. P-values obtained from t-tests, P-values in bold mean statistically significant at the 5% level.

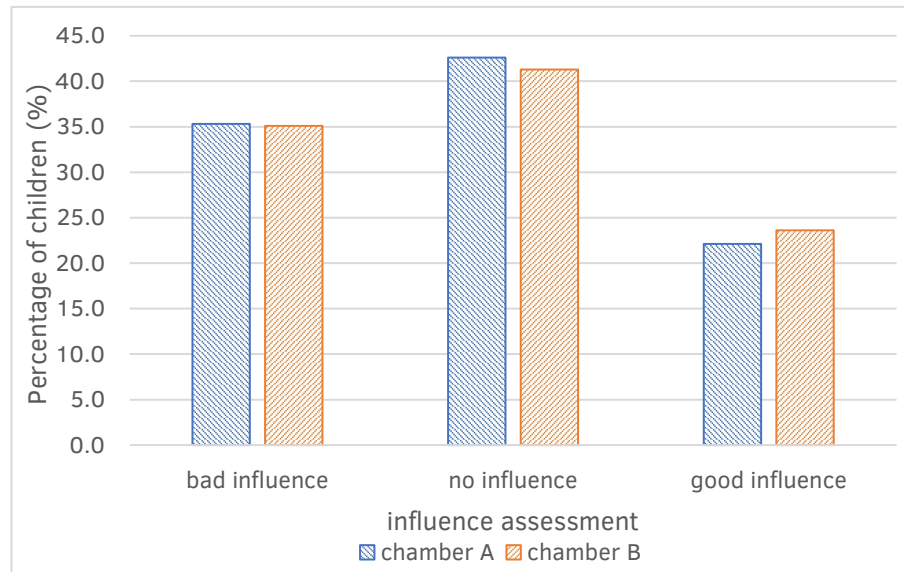

FIG. 5.9 The distribution of children's influence assessment.

5.9.3 Comparison in different background sound conditions

To further clarify the effect of the acoustical treatment of a room on children, all the data were separated into seven files based on the seven background sounds, and then the comparison between these two chambers was conducted again in each of these conditions. The results were shown in Table 5.6.

TABLE 5.6 Comparison between chamber A and chamber B for the different conditions.

	Test scores		Sound perception		Influence assessment	
	t ^a	p ^b	t	p	t	p
45 dB(A) children's talk	$t_{93} = 1.563$	0.121	$t_{90} = -0.872$	0.386	$t_{89} = 1.086$	0.280
60 dB(A) children's talk	$t_{60} = 3.469$	0.001	$t_{59} = -1.926$	0.059	$t_{56} = -0.562$	0.576
45 dB(A) traffic	$t_{73} = 1.847$	0.069	$t_{70} = -1.864$	0.066	$t_{69} = -1.588$	0.117
60 dB(A) traffic	$t_{109} = -0.420$	0.675	$t_{108} = -1.977$	0.051	$t_{106} = -0.793$	0.430
45 dB(A) music	$t_{67} = 0.251$	0.803	$t_{62} = 0.347$	0.730	$t_{62} = -0.569$	0.572
60 dB(A) music	$t_{90} = -1.704$	0.092	$t_{91} = -2.139$	0.035	$t_{90} = 0.278$	0.781
No sound	$t_{62.2} = -1.038$	0.303	$t_{59} = -2.253$	0.028	$t_{57} = 0.368$	0.380

Notes: a. The t-value that obtained from the t-tests measured the size of the difference relative to the variation in the sample data; The greater the t-value (either positive or negative), the greater the evidence that there is a significant difference; b. P-values obtained from the t-tests; P-values in bold mean statistically significant at the 5% level.

Performance test

The differences of children's test scores were not significant in almost all the sound conditions, except for one: the '60 dB(A) children's talk' (p=0.001). Under this condition, as shown in Figure 5.10, children performed significantly better in chamber A (mean=3.1) than in chamber B (mean=2.5). Besides, this tendency can also be seen under the '45 dB(A) children's talk' and '45 dB(A) traffic' sound conditions, although the differences were not significant. On the contrary, when the background sound was '60 dB(A) music' or 'no sound', children performed slightly better in chamber B.

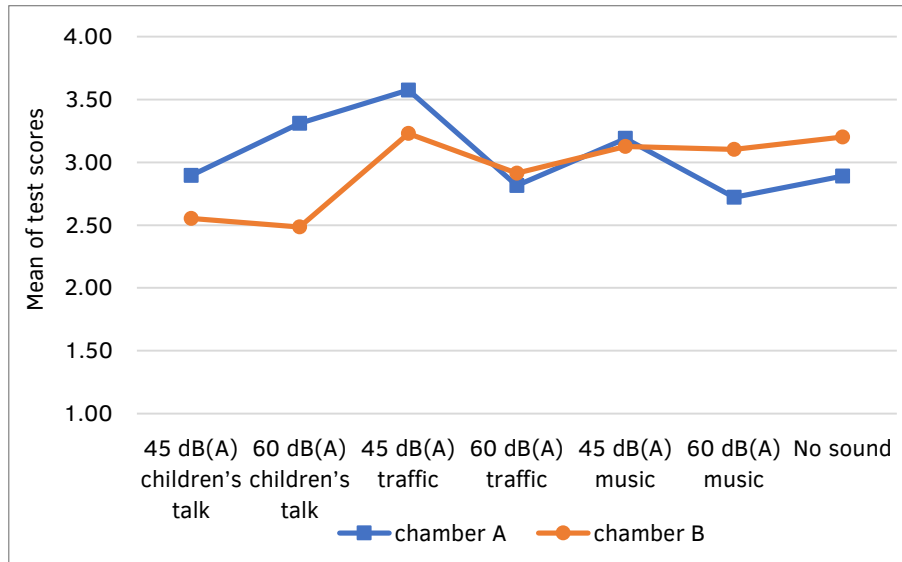

FIG. 5.10 Difference of children's test scores between Chamber A and B.

Sound perception

Among the seven sound conditions, the statistically significant differences of children's sound perceptions between these chambers can be found in the '60 dB(A) music' ($p=0.035$) and the 'no sound' ($p=0.028$) conditions. Under these two conditions, as shown in Figure 5.11, children evaluated chamber A to be noisier than chamber B. The same tendency can be seen in most of the other conditions, except for the '45 dB(A) music'. Under this condition, children's sound perceptions were almost the same for the two chambers.

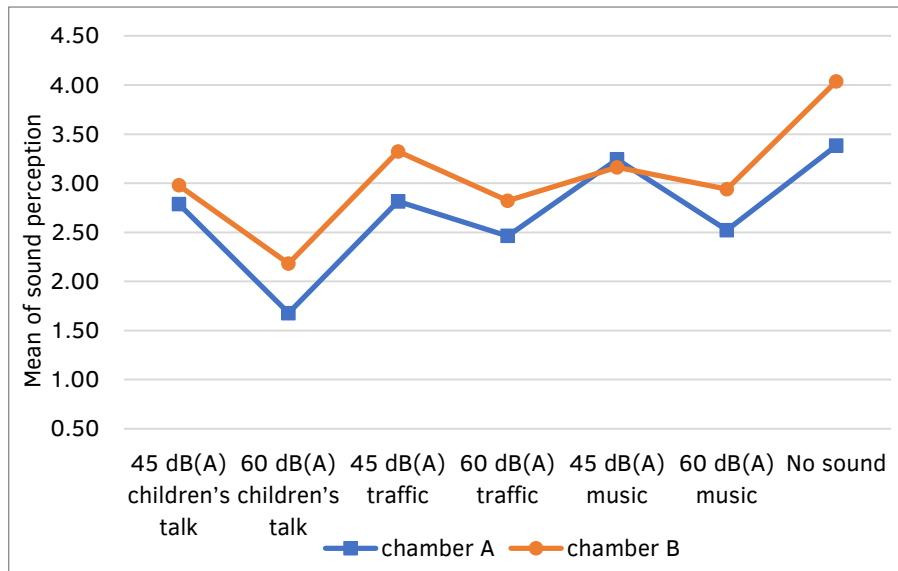

FIG. 5.11 Difference of children's sound perceptions between Chamber A and B.

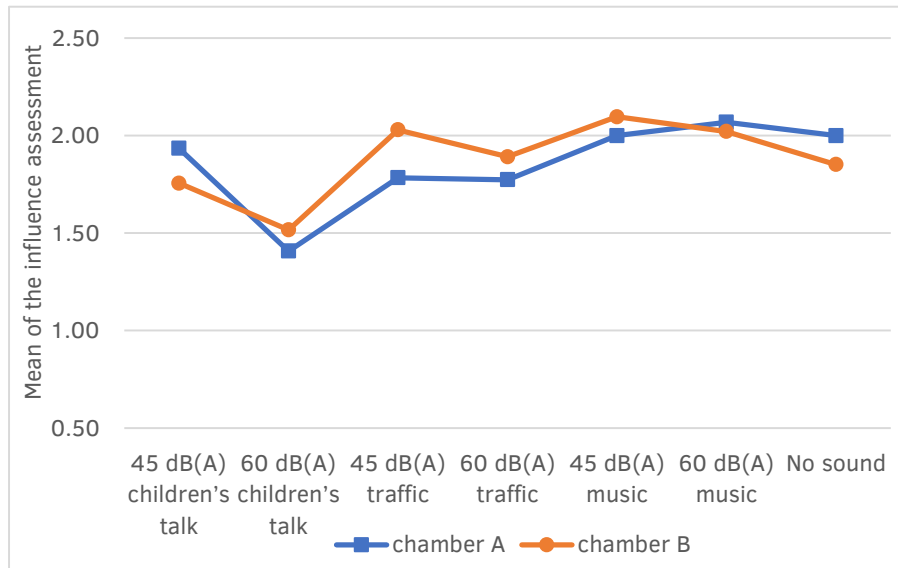

FIG. 5.12 Difference of children's influence assessment between Chamber A and B.

Influence assessment

With respect to the differences of children's influence assessment between these chambers, none of them was statistically significant under these background sound conditions. The fluctuation of children's assessment for these background sounds was quite small, the differences between the highest and the lowest assessment scores were only around 0.6 for both chambers. Children rated either no influence or bad influence for all the background sounds in both chambers.

5.9.4 Children's preference of these chambers

Concerning the last question about the preference of chambers, results showed that more children (58%) preferred chamber B over chamber A. After the separation of data based on the seven background conditions, the same preference was seen in most conditions except for the 'no sound' condition, in which there were slightly more children (53%) preferring chamber A.

5.10 Discussion

Children's talk is the most common noise in classrooms. How to minimize its adverse effect on children's performance and comfort is one of the most important research topics. This study found that under this type of noise, children performed better in the untreated chamber ($RT=0.33s$) than the acoustically treated chamber ($RT=0.07s$). This raised the question about the RT as applied in our guidelines for classrooms. It seems that a lower RT is not always better. At this point, Nijs and Rychtáriková [11] suggested that 0.3s may be the appropriate RT for a quiet classroom with high signal-to-noise ratio; If the RT is too low then overdamping may occur and the loudness of the signal may get too low, then the speech intelligibility might be high but the audibility low. Therefore, the reason why children, in general, performed worse in the treated chamber under noisy conditions might be because of this overdamping and the corresponding low audibility. They performed better in the treated under the 'music' or 'no sound' conditions might be because of the high speech intelligibility. In other words, if there is no noise in the treated chamber, the high speech intelligibility could compensate for the low audibility, while under noisy

conditions, an appropriate RT is much more important. Both the speech intelligibility and the audibility should be kept at its optimum value.

Nevertheless, although the acoustical treatment was not always beneficial to children's performance, it seemed to work well for children's sound perceptions, no matter which type of background sounds. The results attained from this study indicate that the acoustical treatment does have the potential to reduce noise perception, and this is also confirmed by earlier findings on the impact of acoustical covering on noise perception [9].

In addition, this study found that from children's point of view all the background sounds, no matter whether it was noise or music and no matter with or without acoustical treatment, might have an adverse effect on their performance. This verified the conclusion of Shield and Dockrell [12] that noise has a detrimental effect on children's performance, and the conclusion of Hagreaves and Noth [13] that listening to music might impair children's performance since it occupies their cognitive capacity (e.g. identify the instrument, the musical components), and this impact will be more obvious when listening to high arousing music.

5.11 Conclusions

The current study was part of a series of tests performed in the SenseLab [10]. It investigated the effect of acoustical treatment of a room on children's phonological processing performance, sound perception and influence assessment by conducting a series of tests in a laboratory environment.

A statistically significant difference of children's sound perceptions between the acoustically treated chamber and the untreated chamber was found, which demonstrated the positive effect of the acoustic treatment. However, the treatment is not the more the better. It should be done moderately since over-treatment could have adverse effects on children's performance, especially with the 'children's talk' as the background sound.

Based on children's preference of these two chambers, one more conclusion might be attained: as long as there is a background sound, the acoustically treated environment was more welcomed by the children.

References

- [1] Elliott, E.M., The irrelevant-speech effect and children: Theoretical implications of developmental change. *Memory & Cognition*, 2002. 30(3): p. 478-487.
- [2] Blyussen, P.M., D. Zhang, S. Kurvers, M. Overtom, and M. Ortiz-Sanchez, Self-reported health and comfort of school children in 54 classrooms of 21 Dutch school buildings. *Building and Environment*, 2018. 138: p. 106-123.
- [3] Klatte, M., J. Hellbrück, J. Seidel, and P. Leistner, Effects of classroom acoustics on performance and well-being in elementary school children: A field study. *Environment and Behavior*, 2010. 42(5): p. 659-692.
- [4] Catalina, T. and T. Banu, Impact of indoor environmental conditions on students intellectual performance. *Buletinul Institutului Politehnic din Iasi. Sectia Constructii, Arhitectura*, 2014. 60(3): p. 23.
- [5] Rogers, C.L., J.J. Lister, D.M. Febo, J.M. Besing, and H.B. Abrams, Effects of bilingualism, noise, and reverberation on speech perception by listeners with normal hearing. *Applied Psycholinguistics*, 2006. 27(3): p. 465-485.
- [6] Plomp, R. and A. Duquesnoy, Room acoustics for the hearing impaired. *The Journal of the Acoustical Society of America*, 1982. 71(S1): p. S19-S19.
- [7] Nelson, P., K. Kohnert, S. Sabur, and D. Shaw, Classroom noise and children learning through a second language: Double jeopardy? *Language, Speech, and Hearing Services in Schools*, 2005. 36(3): p. 219-229.
- [8] Maxwell, L.E., A safe and welcoming school: What students, teachers, and parents think. *Journal of Architectural and Planning Research*, 2000: p. 271-282.
- [9] Tanner, C.K. and A. Langford, The Importance of Interior Design Elements as They Relate to Student Outcomes. 2003
- [10] Blyussen, P.M., F. van Zeist, S. Kurvers, M. Tenpierik, S. Pont, B. Wolters, L. van Hulst, and D. Meertins, The creation of SenseLab: a laboratory for testing and experiencing single and combinations of indoor environmental conditions. *Intelligent Buildings International*, 2018. 10(1): p. 5-18..
- [11] Nijs, L. and M. Rychtáriková, Calculating the optimum reverberation time and absorption coefficient for good speech intelligibility in classroom design using U50. *Acta Acustica united with Acustica*, 2011. 97(1): p. 93-102..
- [12] Shield, B. and J. Dockrell. The Effects of classroom and environmental noise on children's academic performance. in *9th International Congress on Noise as a Public Health Problem (ICBEN)*, Foxwoods, CT. 2008.
- [13] North, A.C. and D.J. Hargreaves, Music and consumer behaviour. *Oxford handbook of music psychology*, 2009: p. 481-490.

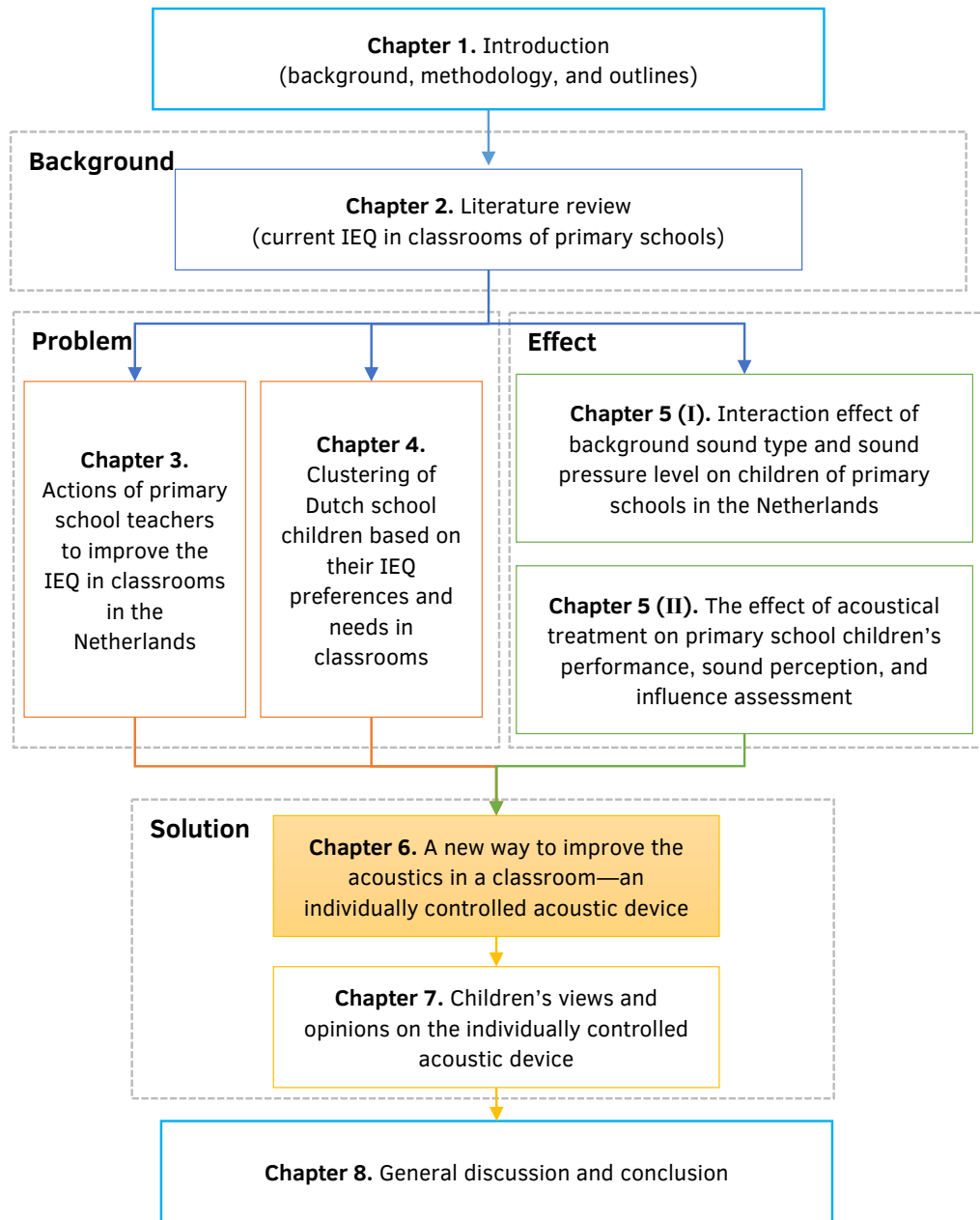

6 Individual control as a new way to improve classroom acoustics: a simulation-based study

The previous chapters indicate that noise is the most serious IEQ problem in classrooms and that it has a detrimental impact on school children; therefore, an urgent action is needed to improve the acoustic quality in classrooms. In recent decades, individually controlled devices have been developed and proved to be capable of improving the IEQ and occupants' satisfaction effectively. However, most of these devices focus on thermal quality or air quality; acoustic-related devices, except headphones, are seldom found in the market. And little research has been done to investigate the effect of individual control of acoustics in classrooms. So, how can one achieve such control, and how well does it work? This chapter pioneers a new individually controlled acoustic device that can be used in classrooms and assesses its function by means of a series of computer simulations and a simple experiment. The result of the simulations demonstrates the effectiveness of this device, and the children's feedback shows the positive response to it.

This chapter is based upon the following article: Zhang, D., Tenpierik, M., & Bluysen, P. M. (2020). A new way to improve the acoustics in a classroom—individual control devices. *Under review (Applied Acoustics)*.

ABSTRACT Previous studies indicate that acoustic improvements at classroom-level, such as using ceiling panels, do not work well to solve noise problems in classrooms. Therefore, this study introduced a new way - individual control - to improve classroom acoustics. The acoustic effect of five different classroom settings is simulated: two individual-level acoustic improvement settings (“Single-sided canopies” and “Double-sided canopies”), two classroom-level acoustic improvement settings (“Half-ceiling” and “Full-ceiling”), and one “Control” setting. The simulation was accomplished with Computer Aided Theatre Technique (CATT-Acoustic™), which is a ray-tracing-based room acoustics prediction software. The simulations were run for two situations: instruction situation and self-study situation, and the Lombard Effect was taken into consideration in the self-study situation. The results showed that for the acoustic environment, all of these settings were better than the “Control” setting, and the individual -level improvements worked better than the classroom-level improvements. It is recommended to produce and test different individually controlled devices in a lab or real classroom to validate these results.

KEYWORDS room acoustics, individual control, ray-based simulation, Lombard effect

6.1 Introduction

In the past decades, the acoustic conditions in classrooms have drawn much attention. Current conditions of acoustic quality in classrooms as well as effects of poor acoustics on children’s health and performance have been studied, and many acoustic guidelines have been issued. A previous Dutch study indicated that noise is the biggest indoor environmental problem in classrooms: 87% of primary school children reported to be bothered by it [1]. One year later, a lab study involved some of the same group of children demonstrated that children perceived sounds better in the acoustically treated room than in the untreated room [2]. Besides, some other studies also showed that poor room acoustics have an adverse impact, not only on children’s school performance [3], but also on their later life [4, 5]. To create an effective learning environment, many recommendations and standards on classroom acoustics have, therefore, been developed.

Most countries have their own acoustic criteria for schools. For example, the United Kingdom Building Bulletin 93 [6] provides a comprehensive guidance and recommendations for the acoustic design of schools. According to it, the teaching and studying space should provide a suitable Reverberation time (RT)

for “clear communication of speech between teacher and student” and for “clear communication between students”. Besides, the Nordic countries also have their own performance criteria, and a previous study found that the RT limits are getting tighter (shorter RT) in these countries [7]. In 2015, the Netherlands tightened its own primary school guidelines which classify three different quality levels (A: very good; B: good; C: acceptable) for the acoustics of classrooms [8].

According to these guidelines and some previous studies, classroom acoustic conditions are usually evaluated by the following parameters: reverberation time (RT), Speech Transmission Index (STI) – or any other speech intelligibility variable –, and Sound Pressure Level (SPL, which is often written as L_p) [6, 9-11]. RT is regarded as an important evaluation indicator in many standards, sometimes it even is the only indicator, and usually only an upper limit is clearly defined, while a lower limit is rarely mentioned [12]. Over the past decades, the requirements concerning RT have become much stricter. Take the Dutch guidelines as an example, even for the classroom with the worst performance level (class C), the average RT (over the 250 to 2000 Hz octave bands) should be lower than 0.8 s, while for the best level (class A), the required RT should be lower than 0.4 s [8]. However, a too low RT could also be a problem since it could lead to overdamping and negatively impact the audibility of sound. Therefore, an extremely low RT should also be avoided [2]. Additionally, the STI is a common index used in many school acoustics guidelines [13]. As a speech metric, the STI describes the effect of room reflections and ambient noise on speech intelligibility [14]. Table 6.1 describes the interpretation of the STI value for the evaluation of speech intelligibility. With respect to the SPL, although it is not used often to assess classroom acoustics, is another vital acoustic parameter that cannot be ignored, especially when it comes to speech intelligibility [15].

TABLE 6.1 Corresponding relation between the STI value and speech intelligibility evaluation.

STI ranges	0.00-0.30	0.30-0.45	0.45-0.60	0.60-0.75	0.75-1.00
Speech intelligibility evaluation	bad	poor	fair	good	excellent

After the implementation of these standards and regulations, much effort has been given to improve the acoustics of many classrooms. A common way is the use of sound absorption materials, such as acoustical ceiling tiles, carpet, and sometimes acoustic wall panels [16]. However, most of these improvements are made at classroom-level; little has been done concerning the preferences and needs of individual child. Only for children with special requirements, some individually controlled devices are available, for example, the use of individual amplification systems for children with hearing loss [17]; or special headphones or earmuffs for

children with autism spectrum disorder or with attention deficit disorder [18, 19]. In fact, individual control, as an effective way to increase satisfaction, has already been used to improve many aspects of indoor environmental quality, such as thermal, air or light quality [20-23]. But is it possible to apply individual control to improve classrooms acoustics? If so, how well do individually controlled acoustic devices work? And what are the pros and cons of individual-level control compared with classroom-level control?

To answer these questions, this present paper, as a first attempt, simulated the acoustic performance of two types of individually controlled acoustic devices in a classroom, and compared the results with the effects of two types of traditional acoustic improvements. Additionally, to clearly demonstrate the acoustic performance of all of these improvements (both at individual-level and at classroom-level), the results were also compared with a control setting without any acoustic improvement. All of the simulations were conducted in two different situations, i.e. the instruction situation and the self-study situation.

6.2 Method

The present study comprised of several computer simulations, conducted by a ray-tracing-based room acoustics prediction software named Computer Aided Theatre Technique (CATT-Acoustic™) [24].

6.2.1 The classroom layout

In this study, the simulated classroom refers to the Experience room in the SenseLab [25]. The room is a box of 6.5 m long, 4.2 m wide, and 3.3 m high. As shown in Figure 6.1, this room contains a glass door (0.98 m × 2.8 m), two windows (0.6 m × 0.8 m), two plenums (below and above), and 16 desks and chairs. A suspended ceiling is installed under the upper plenum, 2.8 m above the floor. It comprises of several lighting panels, perforated steel panels with speakers or air supply (used in the case of mixing ventilation) behind them and sound absorption panels. On the long side of the upper plenum, the air is exhausted via line grills (in the case of displacement ventilation). The computer floor, on top of a plenum 0.45 m above

the ground floor, comprises of panels with linoleum flooring material. Both the floor and the ceiling panels can be changed. All the walls are made of 2 x 8 mm laminated safety glass and can be covered by sound-absorbing wall panels. Along the bottom of the wall, there is a 0.2 m plinth with small holes through which air can be supplied on the long side (in the case of displacement ventilation) and exhausted on the short side (for the mixing ventilation setting).



FIG. 6.1 Experience room in the SenseLab [25].

In the present study, as shown in Figure 6.2, the acoustic conditions of five different settings were simulated. The first one was the “Control” setting (see Figure 6.2(a)), in which no acoustic improvement was implemented. All the surfaces, including the ceiling, were set as reflecting materials (only a little bit of sound absorption). This is an extreme setting and not used in the real room. The second and third settings (see Figure 6.2(b) and (c)) represented classroom-level improvements, with either half or complete covering of the ceiling with acoustic tiles; the wall surfaces comprised entirely of glass. The fourth and fifth settings (see Figure 6.2(d) - (g)) represented the individually controlled improvements, 16 either single or double-sided sound-absorbing canopies were hung above each desk inside the classroom. These canopies had two working modes: open mode (see Figure 6.2(d) and (f)), used during teacher’s instructions, and closed mode (see Figure 6.2(e) and (g)), used during self-study of the school children.

6.2.2 Acoustic model

One of the main difficulties for an accurate simulation is the availability of acoustic information of the materials. In this study, the information of most materials was not available. Therefore, the initial simulation model was built based on estimated values of the sound absorption and scatter coefficients found in literature; then the input data was adjusted correspondingly to make sure that the simulated results were close enough to the values measured inside the room.

In the simulation, all the materials, including ceiling tiles, wall panels, glass, floor and furniture, were set as the same materials used in the Experience room of the SenseLab. Two of them were sound-absorbing materials, namely the ceiling tiles “Ecophon Master™ A” and the wall panels “Ecophon Akusto Wall A”. Their data was taken from the manufacturer’s website, while for the other materials the values were taken from two absorption coefficients tables from previous studies [26, 27]. Based on this, the first simulation was conducted and the results were compared with the measured results. Then, the absorption coefficients and the scatter coefficients of these materials were adjusted accordingly to run the next simulation. After several iterations, the final absorption and scatter coefficients of all the materials were set (Table 6.2). The final comparison between the simulated and the measured results, being the validation of the simulation model, is introduced in the next section.

TABLE 6.2 Absorption and scattering coefficients of different materials.

	125 HZ	250 HZ	500 HZ	1k HZ	2k HZ	4k HZ
Ecophon Focus A	0.50	0.70	0.60	0.58	0.70	0.55
	<i>0.10</i>	<i>0.10</i>	<i>0.10</i>	<i>0.10</i>	<i>0.10</i>	<i>0.10</i>
Ecophon Akusto Wall A	0.40	0.50	0.65	0.76	0.90	0.99
	<i>0.10</i>	<i>0.10</i>	<i>0.10</i>	<i>0.10</i>	<i>0.10</i>	<i>0.10</i>
Linoleum	0.08	0.07	0.05	0.05	0.06	0.02
	<i>0.10</i>	<i>0.10</i>	<i>0.10</i>	<i>0.10</i>	<i>0.10</i>	<i>0.10</i>
Glass	0.09	0.05	0.07	0.068	0.025	0.01
	<i>0.10</i>	<i>0.10</i>	<i>0.10</i>	<i>0.10</i>	<i>0.10</i>	<i>0.10</i>
Metal	0.10	0.08	0.04	0.04	0.05	0.01
	<i>0.10</i>	<i>0.10</i>	<i>0.10</i>	<i>0.10</i>	<i>0.10</i>	<i>0.10</i>
Furniture	0.02	0.02	0.02	0.02	0.04	0.03
	<i>0.10</i>	<i>0.10</i>	<i>0.10</i>	<i>0.10</i>	<i>0.10</i>	<i>0.10</i>

Note: All the upright values are the absorption coefficients, and all the italic values are the scatter coefficients.

The amount of sound-absorbing material used in each setting was calculated to evaluate its effectiveness. As shown in Figure 6.2, for the “Control” setting (a), no sound-absorbing material was used, so, the amount of the additional sound-absorbing material was 0 m². For the “Half ceiling” setting (b), half of the ceiling was covered with sound-absorbing ceiling tiles, the geometric amount of which was 13.5 m². This setting corresponded to the real setting in the Experience room. The ceiling panels that do not contain sound absorbing panels contain lighting fixtures or perforated panels with speakers or air supply. For the “Full ceiling” settings (c), as the name suggests, the whole ceiling was covered with sound-absorbing ceiling tiles, and the geometric amount of it was 27.0 m². For the “Single-sided canopies” setting (d) and (e), 16 canopies, whose inner sides were covered by sound-absorbing material, were hung above the desks, and the total geometric amount of sound-absorbing material used in this setting is the same as setting (b), which was 13.5 m². Lastly, for the “Double-sided canopies” setting (f) and (g), there were also 16 canopies but with both sides covered by sound-absorbing material: 27.0 m².

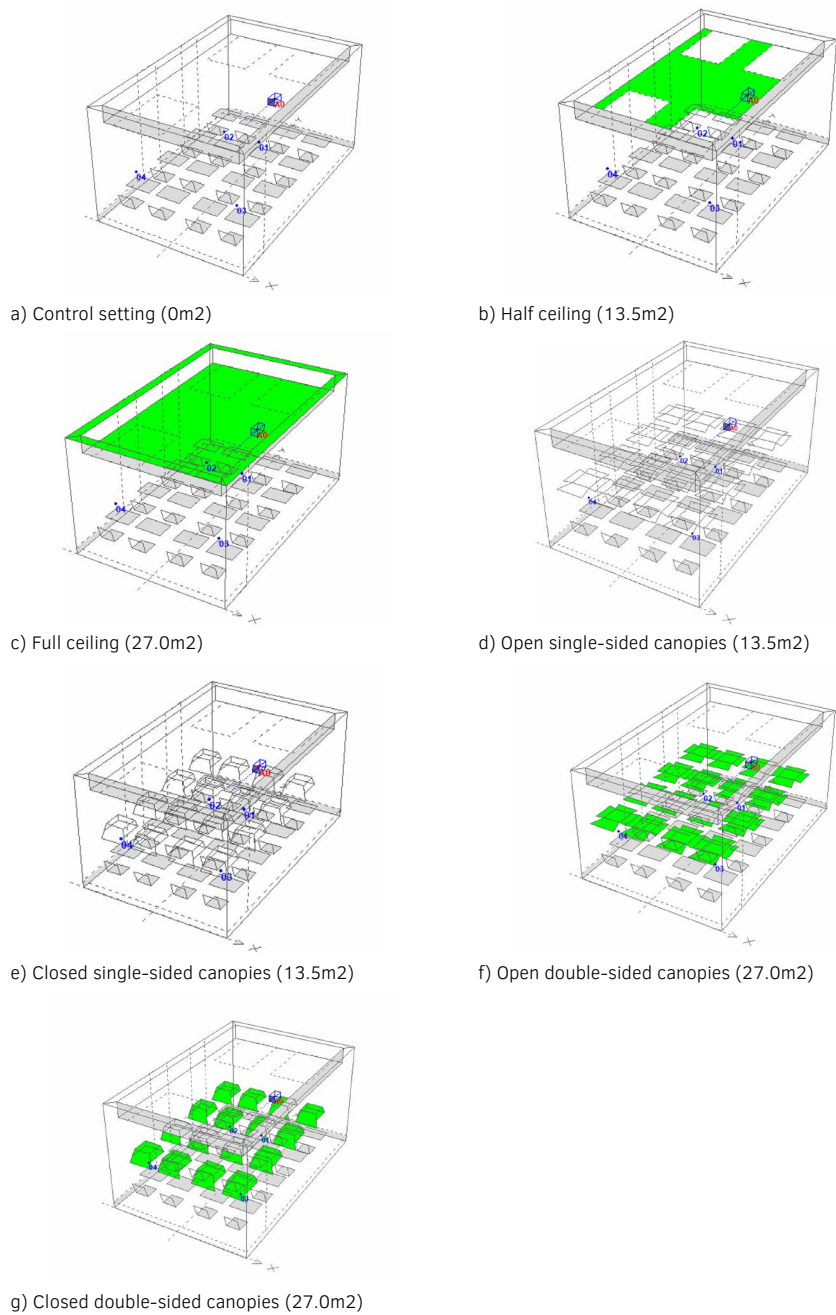
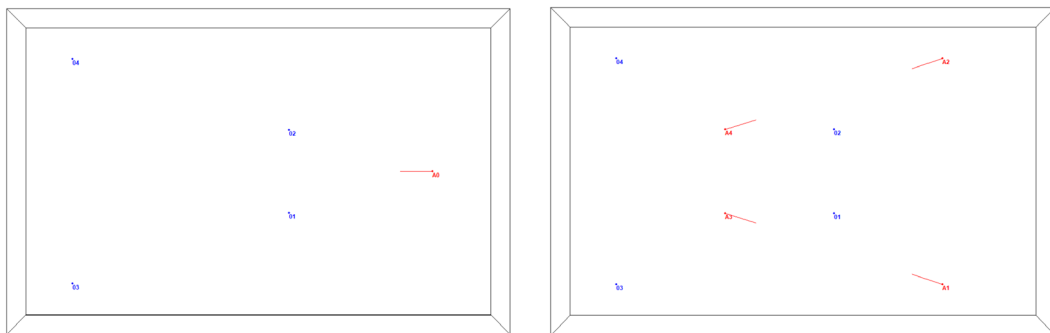

FIG. 6.2 Schematic diagrams of the settings.

6.2.3 Settings of simulations

Sources and receivers

Five sources and four receivers were implemented in the simulation. One source represented the teacher, located at a height of 1.5 m on the centreline of the room, 1.0m from the front wall, and it directed towards the centre of the classroom. This was the only source that was used in the instruction situation (see Figure 6.3(a)). The other four sources represented four talking children, and they were located at a height of 1.1 m in four positions distributed throughout the classroom. These four sources were used in the self-study situation, they were set as two pairs of chatting children: O1 talked with O3, and O2 talked with O4 (see Figure 6.3(b)). The four receivers represented four children and were located at a height of 1.2 m in four positions distributed throughout the classroom. These four receivers were used in both situations. The locations O1 and O2 were chosen on the mean free path from the source A0; the locations O3 and O4 were chosen nearby the corners of the room with 1.0 m distance from the two walls.



a) Instruction situation

b) Self-study situation

FIG. 6.3 Distribution of sources (A0-A4) and receivers (O1-O4).

Prediction method

Three prediction methods can be applied in the CATT-Acoustic™ [24]. The ray-tracing type “Predict S×R” was used in this study because of its advanced algorithms and detailed results for all the combinations of sources and receivers. In terms of the ‘Algorithm’, “Longer calculation with detailed auralization” was selected since it is a

more advanced prediction based on actual diffuse ray split suitable for more difficult cases with uneven absorption. Also, it gives a low random run to run variation at the expense of a longer calculation time. ‘Number of rays’ was set to “auto”, and it can be continuously fine-tuned using the algorithm. ‘Echogram length’ was set to the default value (1000 ms) for most settings, except for the “Control setting”, in which the ‘Echogram length’ was set to “auto”, to make sure it is longer than the estimated longest RT of all frequencies. The simulated physical environment was 20 °C with 50 % relative humidity, based on which the air absorption was estimated by the software. Because of the surfaces of the education furniture and the canopies, edge-diffraction was included in the simulations and the ‘specular to diffraction’ option⁷ was selected as a balance between the actual situation and computation time.

6.2.4 Lombard effect

If only one child speaks in a classroom, a certain SPL will be generated; while when several children talk in that classroom, as a common phenomenon, they will begin to speak louder to make sure that their voices can be heard. This effect is known as the Lombard effect [28], and is affected by the presence of absorption materials in a room. In a poor acoustic environment with little absorption, generally the sound pressure level will be higher as a result of which, people will start to speak even louder; while in a good acoustic environment with much sound absorption, the SPL will be lower and the speech intelligibility higher as a result of which people will tend to speak less loud and the number of people who speak will drop as well [29, 30].

To further specify the impact of the Lombard effect, several models were developed in the literature to quantify the influence of this effect on the total SPL in a room with N speakers. For example, Nijs et al. [29] developed a model to determine the vocal output of a speaker under different acoustic conditions, which is expressed as follow:

$$L_{W,mean} = 10 \log \left(10^{C/10} + 10^{(D+EL_{noise})/10} \right) \quad (1)$$

Where $L_{W,mean}$ represents the mean value of the vocal power output [dB], L_{noise} represents the background noise level [dB], and C, D, E are three empirical constants. This model is based on a curve which is shown in Figure 6.4 with two asymptotic lines: the horizontal line corresponds to the low noise level, and the inclined line corresponds to the high noise level. It describes two conditions:

1) a lower background noise level, in which the vocal power output is assumed to be more or less constant, and 2) a higher background noise level, larger than the inflection level (around 50 dB), in which the vocal power output rises with a slope called the Lombard slope. According to this model, the Lombard slopes varies from 0.2 dB/dB at a background level of 50 dB to 0.5 dB/dB at a background level of 80 dB.

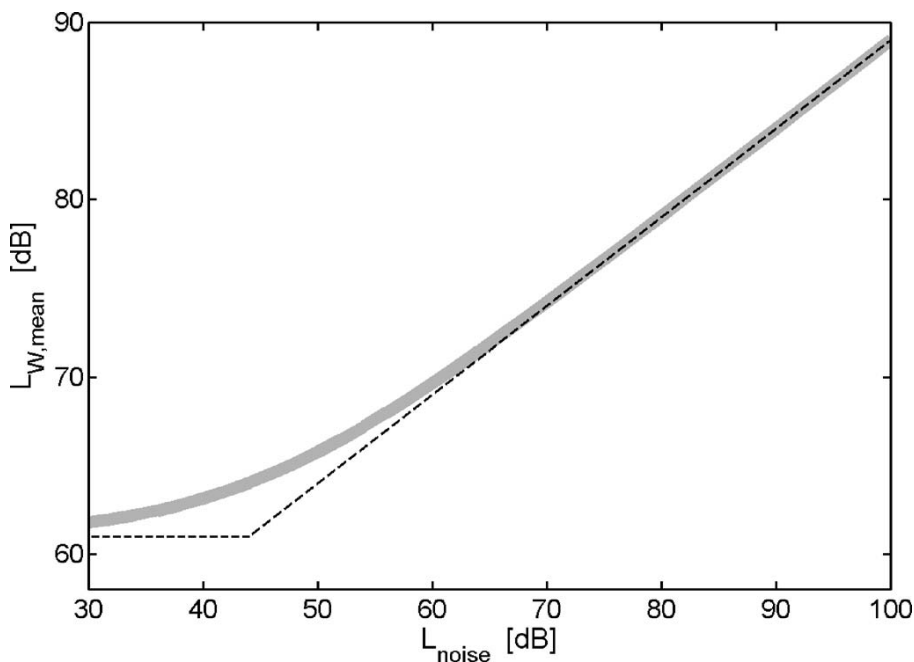

FIG. 6.4 A model to describe the Lombard effect [29].

In addition, Lazarus put forward another formula to describe communication under noisy conditions [31]. It is given for the SPL at 1 m:

$$SPL \text{ at } 1 \text{ m} = c(L_{NA} - 44) + 54 + DLs \quad (2)$$

Where, $c=0.5$, represents the Lombard slope [dB/dB];

L_{NA} represents the ambient noise level [dB];

$DLs = 0 - 6$ dB, represents the speech level increase.

Also, de Ruiter has studied this problem, and his ideas are reflected in Equation (3) [32]. He first came up with the concept of “ $A / N_{present}$ ”, which represents the number of square meters of absorption per person.

$$SPL = K_0 - 20 \log(p) - 20 \log \left(\frac{A}{N_{present}} \right) \quad (3)$$

In this formula, p indicates the number of speakers per person present, K_0 is a value depending on p (see Table 6.3), and $A / N_{present}$ is the amount of sound absorption per person [m^2 Sabin].

TABLE 6.3 The value of K_0 .

Percentage of speakers	20	25	30	35
K_0	93.0	91.0	89.5	88.6

All of these models have been compared and analysed in a previous study, of which detailed information can be found in [33]. However, most of these models were built based on measurements with adults. However, according to Whitlock and Dodd [34], the difference of the Lombard effect between adults and children cannot be ignored. Therefore, they developed another model (see Equation (4)) to predict the total SPL in classrooms with talking children.

$$F = \frac{B - SL + 10 \log N - 20 \log \left(0.057 \sqrt{\frac{V}{T}} \right)}{1 - L} \quad (4)$$

Where:

B is the base (resting) voice level [dB];

S is the starting level for the Lombard effect [dB];

L is the Lombard coefficient, [dB/dB];

N is the number of speaking children, -;
V is the volume of the classroom [m^3];
T is the reverberation time of the classroom [s].

Based on their experiments with children, the coefficients were determined as follow:
B=53.4 dB(A), S=25.7 dB(A), and L=0.19 dB/dB.

6.3 Validation of the simulations

As mentioned in section “6.2.2 Acoustic model”, several RT measurements were performed to validate the simulation results inside the Experience room in the SenseLab for the different settings. During the measurements an omni-directional source (Norsonic Nor276) with power amplifier (Norsonic Nor280) was used, connected to a laptop via a Behringer UCA222 audio interface, and a sound analyser (Norsonic Nor140) as microphone, connected to the same laptop via the same audio interface, was used. The height of the centre of the speaker was 1.4 m above the floor and of the microphone 1.2 m above the floor. Via the computer, logarithmic sweep signals were generated and played by the sound source. The raw signal was recorded by the sound analyser and transferred to the laptop where it was analysed in a custom-made MATLAB script. Per measurement 4 sweeps were generated and averaged before calculating the RT (T-20 and T-30) using regression analysis. The size of the room was exactly the same as the simulated classroom and unoccupied during the measurements. Only the instruction situation was taken into consideration; the position of the speaker was the same as the source no. 1 in the simulations; the receiver points were the same as the four receivers in the simulations (see Figure 6.5 and Figure 6.6).



FIG. 6.5 Setting of the classroom in the SenseLab.

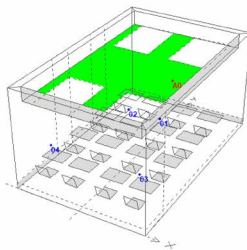

a) Glass wall (27.3 m²)

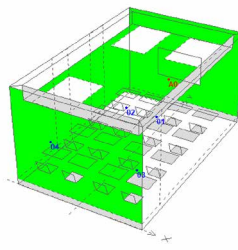

b) Half-acoustic wall (54.7 m²)

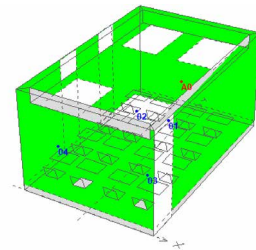

c) All-acoustic wall (97.1 m²)

FIG. 6.6 Figure 6.6 Settings in the verified simulation.

The geometric amounts of sound-absorbing material used in these settings (for the validation of the model only) were as follows:

- Setting (a), the whole ceiling, except for the lighting area, was covered with sound-absorbing material, and the corresponding geometric area was 27.3 m²;
- Setting (b), next to the ceiling, additionally the front and rear walls of the room were covered with acoustic panels, the corresponding geometric area was 54.7 m²;
- Setting (c), next to the ceiling, additionally all the walls, except for the windows and door area, were covered with sound-absorbing materials, the corresponding geometric area was 97.1 m².

The results of the measurements and the simulations are shown in Table 6.4. In the “No panel” setting (a) and “All panels” setting (c), the differences between the simulation results and the measurement results were quite small (less than 0.1 s, which is the just noticeable difference for reverberation time). As indicated by previous studies [35], the simulated results can hardly be identical to the measured ones because of the measurement errors and discrepancy between the real object and its physical and mathematical model. Therefore, in this study, 0.1 s difference between the simulated and measured RTs was assumed to be satisfactory, which was achieved in the “All panels” and “No panel” settings. For the “Half panel” setting (b), the difference was larger, which might be caused by the non-diffuse sound field due to the uneven distribution of the sound-absorbing materials, namely the higher absorption of the two short walls and the lower absorption of the two long walls. Considering all of these settings, the simulation model was considered to be valid enough for the purpose of this study. For the remainder of this study – the actual simulations – the walls were not covered with absorption material but were all comprising of glass.

TABLE 6.4 Comparison of reverberation Time resulting from measurements and simulations.

No panel	125	250	500	1k	2k	4k	Average (125-4K)
Position 1	0.79	0.92	0.86	0.88	1	1.15	0.93
	<i>0.63</i>	<i>1.00</i>	<i>0.75</i>	<i>0.81</i>	<i>1.02</i>	<i>1.26</i>	0.91
Position 2	0.79	0.9	0.86	0.87	0.98	1.15	0.93
	<i>0.68</i>	<i>0.99</i>	<i>0.76</i>	<i>0.81</i>	<i>1.01</i>	<i>1.30</i>	0.93
Position 3	0.81	0.91	0.87	0.89	1.07	1.16	0.95
	<i>0.94</i>	<i>0.93</i>	<i>0.77</i>	<i>0.76</i>	<i>0.96</i>	<i>1.12</i>	0.91
Position 4	0.87	0.93	0.87	0.88	0.99	1.16	0.95
	<i>0.92</i>	<i>0.81</i>	<i>0.78</i>	<i>0.76</i>	<i>0.96</i>	<i>1.19</i>	0.90
Average (4 positions)	0.82	0.92	0.87	0.88	1.01	1.16	0.94
	<i>0.79</i>	<i>0.93</i>	<i>0.77</i>	<i>0.79</i>	<i>0.99</i>	<i>1.22</i>	0.91
Half panels	125	250	500	1k	2k	4k	Average (125-4K)
Position 1	0.56	0.56	0.52	0.51	0.55	0.55	0.54
	<i>0.69</i>	<i>0.67</i>	<i>0.68</i>	<i>0.68</i>	<i>0.69</i>	<i>0.76</i>	0.70
Position 2	0.56	0.57	0.52	0.51	0.55	0.56	0.55
	<i>0.77</i>	<i>0.75</i>	<i>0.70</i>	<i>0.68</i>	<i>0.63</i>	<i>0.69</i>	0.70
Position 3	0.56	0.56	0.52	0.52	0.56	0.57	0.55
	<i>0.65</i>	<i>0.73</i>	<i>0.67</i>	<i>0.67</i>	<i>0.65</i>	<i>0.71</i>	0.68
Position 4	0.56	0.57	0.52	0.52	0.58	0.59	0.55
	<i>0.70</i>	<i>0.74</i>	<i>0.68</i>	<i>0.68</i>	<i>0.68</i>	<i>0.74</i>	0.70
Average (4 positions)	0.56	0.56	0.52	0.51	0.56	0.57	0.55
	<i>0.70</i>	<i>0.72</i>	<i>0.68</i>	<i>0.68</i>	<i>0.66</i>	<i>0.73</i>	0.70
All panels	125	250	500	1k	2k	4k	Average (125-4K)
Position 1	0.37	0.29	0.26	0.23	0.19	0.20	0.25
	<i>0.37</i>	<i>0.21</i>	<i>0.22</i>	<i>0.17</i>	<i>0.14</i>	<i>0.15</i>	0.21
Position 2	0.36	0.28	0.25	0.24	0.19	0.20	0.26
	<i>0.27</i>	<i>0.25</i>	<i>0.22</i>	<i>0.17</i>	<i>0.15</i>	<i>0.16</i>	0.20
Position 3	0.37	0.29	0.26	0.27	0.20	0.22	0.27
	<i>0.36</i>	<i>0.29</i>	<i>0.19</i>	<i>0.19</i>	<i>0.16</i>	<i>0.16</i>	0.23
Position 4	0.36	0.29	0.27	0.23	0.21	0.21	0.26
	<i>0.45</i>	<i>0.27</i>	<i>0.19</i>	<i>0.15</i>	<i>0.16</i>	<i>0.17</i>	0.23
Average (4 positions)	0.36	0.29	0.26	0.24	0.20	0.21	0.26
	<i>0.36</i>	<i>0.26</i>	<i>0.21</i>	<i>0.17</i>	<i>0.15</i>	<i>0.16</i>	0.22

Notes: All the italics represent the measurement results; all upright numbers the simulation results.

6.4 Results of the simulations

The simulations were conducted for two different scenarios: one without the Lombard Effect (both the instruction and the self-study situation), and one with the Lombard Effect (only the self-study situation).

6.4.1 Instruction situation (without Lombard Effect)

In the instruction situation (with frontal teaching), the ultimate purpose of the classroom was to provide an acoustic environment in which the teacher's voice can be clearly transmitted to each child, which corresponds to a high STI and a short RT. Considering that, the acoustic performance in the "Control setting" was the worst among the five simulated settings. As shown in Table 6.5, the average (over 250 to 2k Hz octave bands) T-30 in the "Control" setting was 1.66 s which is significantly higher than the maximum value allowed by the Dutch guidelines (Fresh Schools 2015) [8] for the worst level (class C), and the STI just reached the fair level (see Table 6.1). Compared with the "Control setting", all the improvement settings, both the addition of acoustic ceiling tiles and the implementation of acoustic canopies, did achieve better acoustics, namely by shortening the average RT and increasing the average STI significantly.

TABLE 6.5 General acoustic simulation results in the instruction situation.

Situation	Settings	RT (s)	SPL (dB(A))	STI (-)
Instruction (Teacher's speaking)	Control	1.66	59.3	0.49
	Half ceiling	0.93	55.8	0.63
	Full ceiling	0.87	53.8	0.69
	Single-sided canopies	0.92	56.1	0.64
	Double-sided canopies	0.85	54.2	0.70

Note: all the results are the average values of 4 positions and RT and SPL averaged as well over the 250 to 2k Hz octave bands.

In general, the results of the "Double-sided canopies" setting and the "Full ceiling" setting were similar because of the same amount of sound-absorbing materials used in these two settings. Similarly, the results of the "Single-sided canopies" setting and the "Half ceiling" setting were also similar. In general, the settings with more absorption material worked better because of the lowest RTs and the highest STIs. And among these, the "Double-sided canopies" setting was even slightly better

because in this setting not only the RT was lower and the STI higher, but also the SPL was slightly higher, so that all of the children could better hear and understand their teacher's speech.

The detailed results for the four different receiver positions are shown in Figure 6.7. No matter for which position, the improvement settings led to better acoustic conditions as compared with the "Control setting". Concerning RT, among the four improvements, the "Double-sided canopies" provided the shortest average value, but showed more variation among the four receiver points as compared to the other settings. The RT in the rear positions was longer than in the front positions, and this trend was most clearly found for this setting. Concerning SPL, compared with the other improvements, the "Single-sided canopies" led to the highest value. For all the improvements, the distribution of SPL among these positions was quite uneven, the SPL in the rear positions was lower than in the front positions. Concerning the STI, the "Double-sided canopies" provided the best result and an even distribution among all positions.

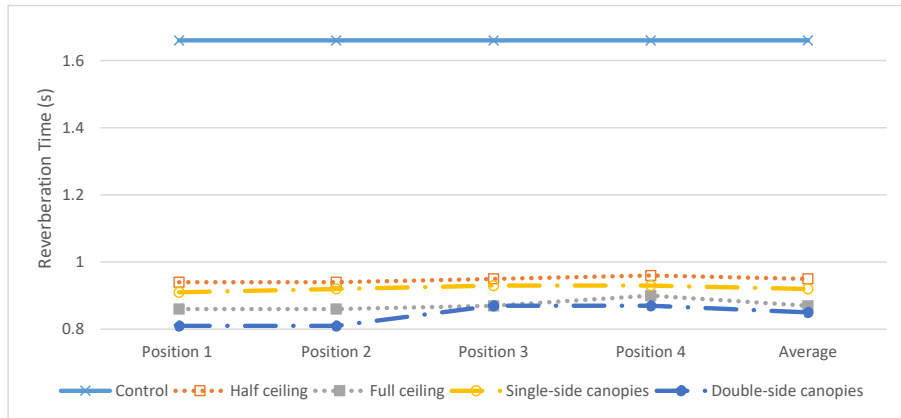

a)

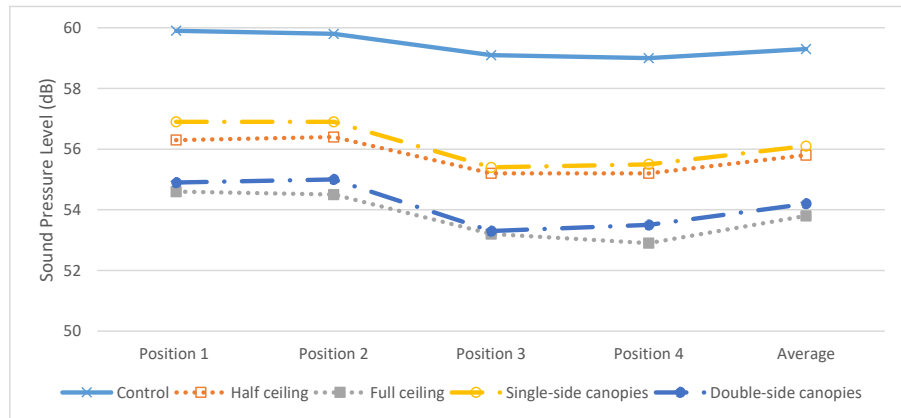

b)



c)

FIG. 6.7 Acoustic simulation results in different positions in the instruction situation.

6.4.2 Self-study situation without Lombard effect

In the self-study situation (with children talking), a quieter classroom provides a better learning environment. In a quiet environment, every child should be able to concentrate on their own schoolwork and avoid being distracted by other children's conversation. In this case, as shown in Table 6.6, the "control" setting was still the worst since the average SPL in this setting was the highest. Moreover, the RT and STI in this setting were also poor, and the values were similar to the results in the instruction situation. A plausible explanation could be that the simulated configurations in these two situations were the same, only the sound source was changed from one frontal source (in the instruction situation) to four sources distributed throughout the room (in self-study situation).

TABLE 6.6 General acoustic simulation results in the conversation situation.

Situation	Settings	RT	SPL	STI
Self-study (children's talking)	Control	1.66	63.1	0.49
	Half ceiling	0.95	59.8	0.63
	Full ceiling	0.89	58.0	0.69
	Single-sided canopies	0.72	58.8	0.70
	Double-sided canopies	0.68	57.5	0.74

In contrast to the "Control setting", the acoustic improvements in the other four settings are clear: both the RT and SPL decreased, and the STI increased significantly. Comparing these improved settings, the "Double-sided canopies" setting was the best because in this setting both the RT and SPL were the lowest. Next were the "Single-sided canopies" and the "Full ceiling". The average results for these two settings were similar although the amount of sound absorbing materials used in the "Full-ceiling" setting was twice as much as in the "Single-sided canopies" setting. The worst acoustic environment occurred in the "Half ceiling" setting.

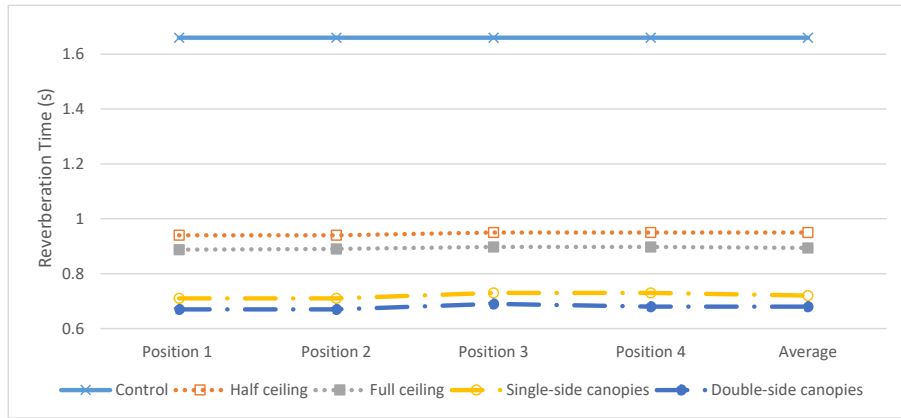

a)

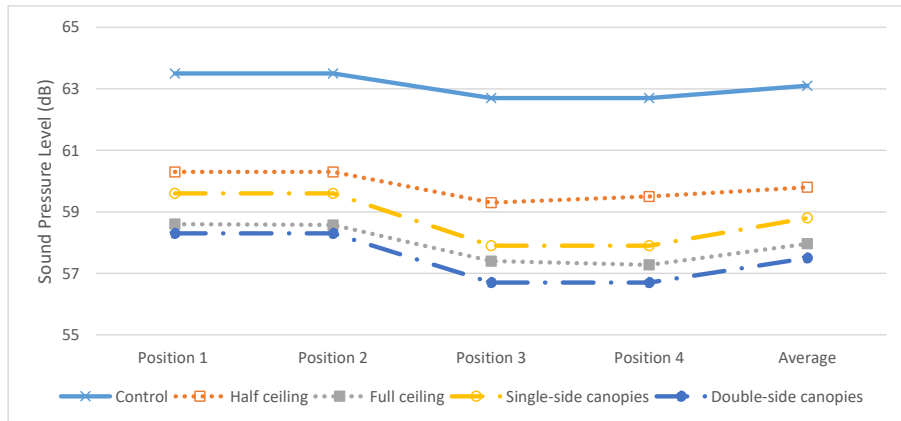

b)

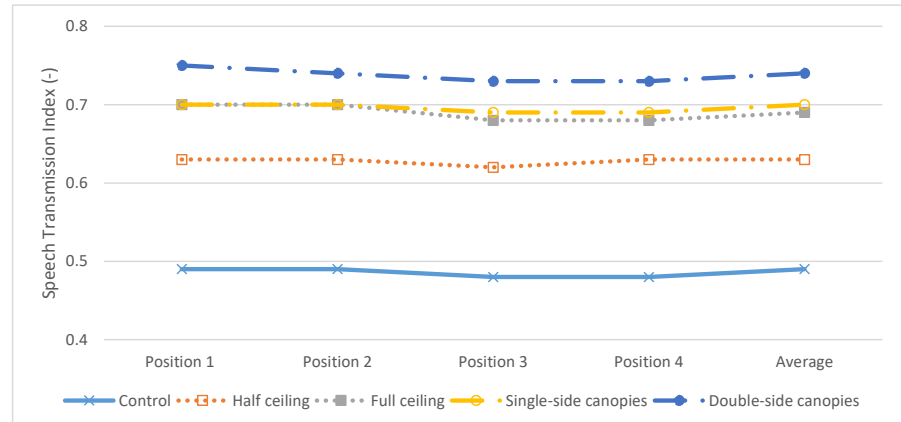

c)

FIG. 6.8 Acoustic simulation results in different positions in the self-study situation.

The detailed results for the different positions are shown in Figure 6.8. Concerning RT, the values in the two “canopies” settings were similar. The same also applied for the two “Ceiling” settings. Moreover, the “Canopies” settings were better than the “ceiling” settings. For all the settings, the differences in RT among the different positions were not significant. In terms of the SPL, the “Double-sided canopies” setting was the best, next were the “Full ceiling” and the “Single-sided canopies” settings, while the “Half ceiling” setting was the worst. For all settings, the SPLs in the rear positions were lower than in the front positions, which might be caused by the fact that positions 1 and 2 were just in between four talking children (see Figure 6.3(b)), while positions 3 and 4 were only close to two talking children. With respect to the STI, the highest value occurred in the “Double-sided canopies” setting, followed by “Single-sided canopies” and “Full ceiling” settings, in which similar results were observed, while the “Half ceiling” setting resulted in the lowest index among the improved settings. Additionally, the distribution of the STIs among the four positions was relatively even.

6.4.3 Self-study situation with Lombard Effect

To make the simulations more accurate, the Lombard Effect was accounted for, but only in the self-study situation (with children talking) because in the instruction situation only one sound source, namely the teacher, was assumed to be present. In the simulation involving the Lombard Effect, the total SPL in the classroom should be higher than in the simulation without the Lombard Effect. To simulate this effect, the increase of each speaker’s voice level was calculated as follows:

- 1 Assuming a base condition where only one child is talking in a classroom. According to Equations (4), the SPL in this room should be:

$$L_{p,\text{base}} = \frac{B - SL + 10 \log 1 - 20 \log \left(0.057 \sqrt{\frac{V}{T}} \right)}{1 - L} = \frac{B - SL - 20 \log \left(0.057 \sqrt{\frac{V}{T}} \right)}{1 - L} \quad (5)$$

- 2 Increasing the number of talking children to 4. If the Lombard Effect was taken into account, then according to Equations (4), the SPL in this room should be:

$$\begin{aligned}
L_{p,4\text{children with LE}} &= \frac{B - SL + 10\log 4 - 20\log\left(0.057\sqrt{\frac{V}{T}}\right)}{1 - L} \\
&= L_{p,\text{base}} + \frac{10\log 4}{1 - L} = L_{p,\text{base}} + 7.41
\end{aligned}
\tag{6}$$

- 3 If the Lombard Effect was not involved, based on the formula to calculate the combined SPL mentioned in [36], the total SPL in this room should be:

$$\begin{aligned}
L_{p,4\text{children without LE}} &= 10\log\left(N10^{\frac{L_{p,\text{base}}}{10}}\right) \\
&= 10\log\left(410^{\frac{L_{p,\text{base}}}{10}}\right) = L_{p,\text{base}} + 10\log 4 = L_{p,\text{base}} + 6
\end{aligned}
\tag{7}$$

(4) Adjusting the sound pressure level of the sources by comparing the results between the calculation with and without Lombard Effect. The difference of children's voice level additionally increased by 1.41 dB(A) in the simulation involving the Lombard Effect.

Because of the Lombard Effect, in the simulations conducted in this section, therefore, the SPL of each source was increased by 1.41 dB(A), but keeping all the acoustic and geometrical settings the same as in the simulations without the Lombard Effect (i.e. Section 6.4.2). Thus, comparing the results with Lombard Effect to the results without Lombard Effect showed that RT and STI were almost the same, only the SPL was higher (see Table 6.6 and Table 6.7). Moreover, the ranking of these parameters among these five settings were also the same as in the last section. Concerning the RT and the STI, from the "Control" setting to the "Half-ceiling" setting, to the "Full-ceiling" setting, to the "Single-sided canopies" setting, to the "Double-sided canopies" setting, the acoustic conditions become better; while concerning the SPL, the rank of "Full ceiling" and "Single-sided canopies" changed; in this situation, the "Full ceiling" provided a slightly quieter environment than the "Single-sided canopies".

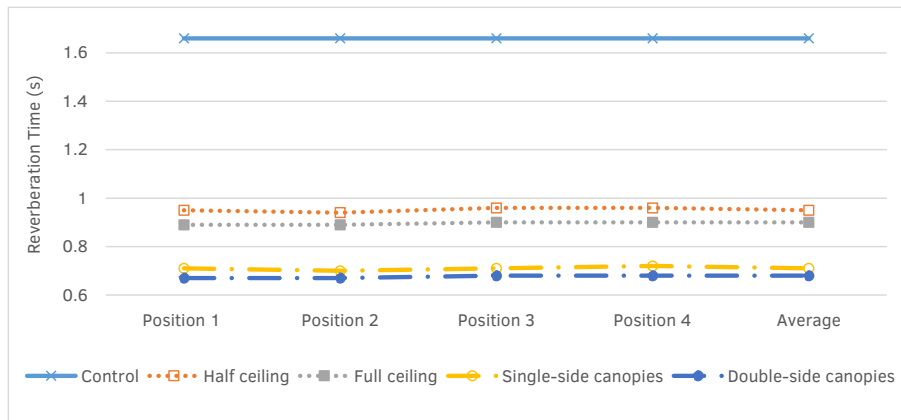

a)

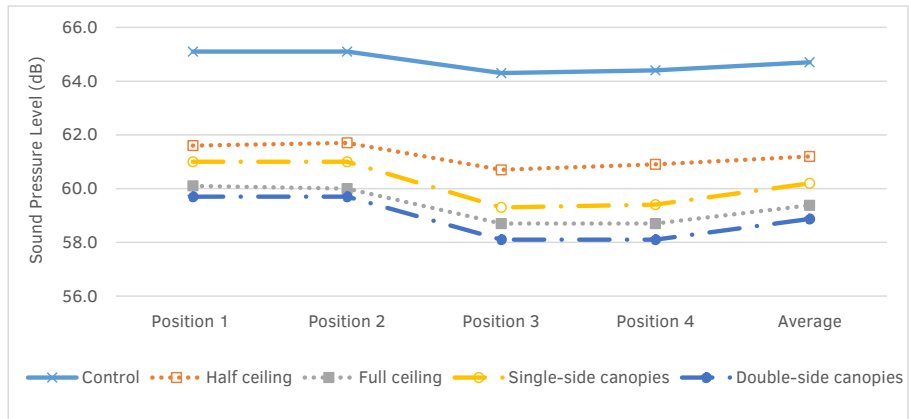

b)

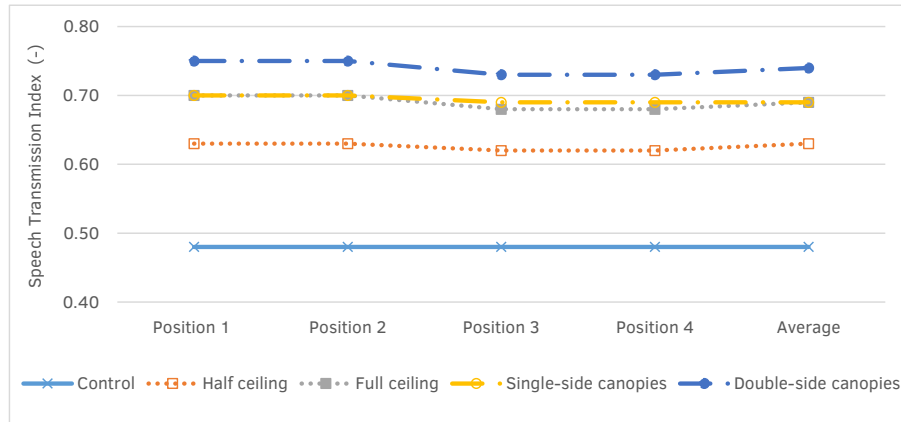

c)

FIG. 6.9 Acoustic simulation results in different positions in the conversation situation.

TABLE 6.7 General acoustic simulation results in the conversation situation.

Situation	Settings	RT	SPL	STI
Self-study (children talking)	Control	1.66	64.7	0.48
	Half ceiling	0.95	61.2	0.63
	Full ceiling	0.90	59.4	0.69
	Single-sided canopies	0.71	60.2	0.70
	Double-sided canopies	0.68	58.9	0.74

The detailed results for the different positions are shown in Figure 6.9. The ranking of the RTs and STIs for the four positions were also the same as for the simulations without the Lombard Effect. This makes sense since the setting of these two series of simulations were exactly the same and only the SPL of the sources was increased in these simulations.

6.5 Discussion

The present study evaluated the acoustic quality in a simulated classroom for five different settings: one control setting, two classroom-level improvements (Half ceiling and Full ceiling) and two individual-level improvements (Single-sided and Double-sided canopies). In each of these settings, two situations were run: instruction situation (frontal teaching) and self-study situation (children talking). The requirements of the acoustic quality in these two situations are different because of the difference in learning activities. During instruction, the transmission of knowledge from teacher to children is the main purpose of the classroom; it should help the teachers' voice to be clearly and loudly transferred to every child's ear. Therefore, achieving a short reverberation time and high speech intelligibility and at the same time keeping the loudness of the teachers' voice should be the aim of the classroom's acoustic design. However, during self-study, the main purpose of the classroom is to create a quiet environment and to keep children from being disturbed by their classmates. In this case, the SPL reduction of children's voices should be the aim. Based on these requirements, the simulated results of these settings were compared and analysed.

6.5.1 **Effect of the classroom-level improvement**

For the ceiling improvements, both the “Half ceiling” and the “Full ceiling” led to a better acoustic environment compared with the “control” setting, and as can be expected, the “Full ceiling” worked better than the “Half ceiling” in terms of shortening the RT. However, the difference in RT between these two settings was not as significant as the difference of the amount of sound-absorbing materials used in these settings. This just proves the conclusion found by Bistafa and Bradley [35] that the more absorption is added, the less accumulated reductions in the average RT can be measured. And in this study, this result might be explained by the fact that the several reflecting zones on the ceiling could contribute to the transmission of the voice to the rear positions. According to the comparison between the results obtained from the instruction situation and the self-study situation, no significant difference in RT and STI was found between these two situations; only the SPL was higher in the self-study situation which is caused by the multiple speakers.

6.5.2 **Effect of the individual-level improvement**

Concerning the individual-level improvements, namely the canopies, the acoustic quality also improved considerably compared with the “Control setting”. Similarly, the “Double-sided canopies” worked better than the “Single-sided” canopies concerning RT and STI, and also here, the difference was not as big as the difference of the amount of sound-absorbing materials used in these settings.

For the comparison between the results obtained from the instruction situation and the self-study situation, the differences of the acoustic variables were significant for both the “Single-sided” and “Double-sided” canopies, although the amount of the sound-absorbing material was exactly the same. Therefore, it could be concluded that the mode/shape of the canopies and the nearness of the absorption material played an important role in the acoustic improvement. The closed canopies in the self-study situation lead to a shorter RT and higher STI than the open canopies in the instruction situation. Bistafa and Bradley [35] found similar results: different RT were achieved when the same amount of absorption was used in different configurations. In the present study, the significant differences between the two situations can be explained by the fact that in the self-study situation the sound sources were located under the canopies when the side wings of the canopies were dropped down, so that the sound-absorbing materials were closer to the sound sources.

6.5.3 The classroom-level improvement vs. individual-level improvement

In terms of RT and STI, both ceiling tiles and individual canopies were found to lead to significant improvements of the acoustic quality in the classroom. In general, the “canopies” provided an even better acoustic environment than the “ceilings”, since the “canopies” tended to result in shorter RT and higher STI than the “ceilings”. When the amount of sound-absorbing materials was kept the same, then the advantages of the “canopies” was even more obvious. In other words, the “Single-sided canopies” were better than the “Half ceiling”, in terms of the acoustic quality, and the “Double-sided canopies” were better than the “Full ceiling”. This difference might be caused by the relatively lower height and the changeable shape of the canopies. In the instruction situation, the open canopies looked like a suspended ceiling below the existing ceiling. In the self-study situation, the closed canopies looked like umbrellas partly covering the sound source, as a result of which the sound could be better absorbed keeping other children from being distracted.

6.5.4 Simulation involving Lombard Effect

To increase the accuracy of the simulation, the Lombard Effect was accounted for in the present study. Although the relationship between people’s speech level and ambient noise level (i.e. Lombard Effect) has been identified by many studies, most of them only focused on adults. However, according to a study conducted by Whitlock and Dodd [34], the Lombard slope is different for children, and based on their formula, the difference of the SPL in the room due to the Lombard Effect was calculated as:

$$\Delta L_p = \frac{10 \log N}{1-L} - 10 \log N = \frac{L}{1-L} 10 \log N \quad (8)$$

Therefore, as the first attempt, this study adjusted the children’s voice level based on this equation (8) in the computer simulation. This adjustment almost did not change the results, except for the SPL, as compared to the original simulations. Nonetheless, the Lombard Effect still needs to be considered when conducting such simulations because it is a real phenomenon, and the closer to reality, the more realistic the simulation will be.

6.5.5 Limitation and strength

This study applied only one research method, namely computer simulation, to test the function of the new individually controlled devices, which might be an optional limitation since there are always differences between simulated and experimental results.

For CATT-Acoustic™, a ray-tracing-based acoustic simulation software, simulating diffraction is a challenge because diffraction inherently is a wave-based phenomenon. In this study, this limitation was minimized by using the latest version of the software which has diffraction implemented in its simulation, albeit in a simplified way. Moreover, in order to further guarantee sufficient accuracy of the simulation, as model validation several repeated trials and comparisons between the simulated and measured results were conducted to reach suitable settings and material properties.

Moreover, currently no individually controlled acoustic improvement device is available to test in an experimental set-up with actual users. While computer simulation is a good way to study a number of different conditions without any risk or additional costs. So, as a “better-faster-cheaper” method, computer simulation can be considered as a strength of this study.

6.5.6 Future studies

Individual control is a general and broad idea; the individually controlled devices simulated in this paper are just two examples of how can individual control could be used to improve classroom acoustics. There are many other types, shapes, and sizes of individually controlled devices possible to be used. In the future, some of them might be produced and tested in a real (field study) or lab environment, providing more information about the functioning of these devices, which could lead to further improvements.

6.6 Conclusion

In conclusion, all the acoustic improvements worked effectively in terms of providing a good acoustic learning environment. But, no matter in which situation, instruction or self-study situation, the individually controlled canopies provided a better acoustic environment than the traditional improvement, the ceiling tiles. In the comparison between the two canopies, the “Single-sided canopies” might be superior to the “Double-sided canopies” for the following two reasons. First, for the RT and STI, in both situations the difference between the two were not significant, while the “Single sided canopies” only uses half of the amount of absorbing materials as the “Double-sided canopies”. Second, for the SPL, in the instruction situation, the “Single-sided canopies” led to a louder environment with teacher’s voice reaching further into the classroom, while in the self-study situation, a marginal difference was observed between these two settings. Based on these results, the “Single-sided canopies” are considered to be the best improvement of the four improvements tested.

References

- [1] Bluysen, P.M., D. Zhang, S. Kurvers, M. Overtoom, and M. Ortiz-Sanchez, Self-reported health and comfort of school children in 54 classrooms of 21 Dutch school buildings. *Building and Environment*, 2018. 138: p. 106-123.
- [2] Zhang, D., M. Tenpierik, and P.M. Bluysen. The effect of acoustical treatment on primary school children's performance, sound perception, and influence assessment. in *E3S Web of Conferences*. 2019. EDP Sciences.
- [3] Zhang, D., M. Tenpierik, and P.M. Bluysen, Interaction effect of background sound type and sound pressure level on children of primary schools in the Netherlands. *Applied Acoustics*, 2019. 154: p. 161-169.
- [4] Anderson, K., Kids in noisy classrooms: What does the research really say. *Journal of Educational Audiology*, 2001. 9: p. 21-33.
- [5] James, D., M. Stead, D. Clifton-Brown, and D. Scott, A cost benefit analysis of providing a 'sound'environment in educational facilities. *Proceedings of the Acoustical Society of Australia*, 2012: p. 21-24.
- [6] Department of Education, Building bulletin 93, Acoustic design of schools: Performance standards. 2015, The National Archives London.
- [7] Rasmussen, B., J. Brunskog, and D. Hoffmeyer. Reverberation time in class rooms—Comparison of regulations and classification criteria in the Nordic countries. in *Joint Baltic-Nordic Acoustics Meeting 2012*.
- [8] The Netherlands Enterprise Agency, Programma Van Eisen Frisse Scholen 2015. 2015.
- [9] Mikulski, W. and J. Radosz, Acoustics of classrooms in primary schools—results of the reverberation time and the speech transmission index assessments in selected buildings. *Archives of Acoustics*, 2011. 36(4): p. 777-793.
- [10] Rabelo, A.T.V., J.N. Santos, R.C. Oliveira, and M.d.C. Magalhães. Effect of classroom acoustics on the speech intelligibility of students. in *CoDAS*. 2014. SciELO Brasil.
- [11] Hirvonen, M., V. Hongisto, M. Kylliäinen, and K. Lehtonen, Standardi SFS 5907 rakennusten akustisesta luokituksesta. 2005, Akustiikkapäivät.
- [12] Christensson, J., Good acoustics for teaching and learning. *The Journal of the Acoustical Society of America*, 2017. 141(5): p. 3457-3457.
- [13] Bradley, J.S., Speech intelligibility studies in classrooms. *The Journal of the Acoustical Society of America*, 1986. 80(3): p. 846-854.
- [14] International Electrotechnical Commission, IEC 60268-16: Sound system equipment-Part 16: Objective rating of speech intelligibility by speech transmission index. 2011.
- [15] Jianxin, P., Chinese speech intelligibility at different speech sound pressure levels and signal-to-noise ratios in simulated classrooms. *Applied Acoustics*, 2010. 71(4): p. 386-390.
- [16] Siebein, G.W., M.A. Gold, G.W. Siebein, and M.G. Ermann, Ten ways to provide a high-quality acoustical environment in schools. *Language, speech, and hearing services in schools*, 2000. 31(4): p. 376-384.
- [17] McKay, S., J.S. Gravel, and A.M. Tharpe, Amplification considerations for children with minimal or mild bilateral hearing loss and unilateral hearing loss. *Trends in amplification*, 2008. 12(1): p. 43-54.
- [18] Ikuta, N., R. Iwanaga, A. Tokunaga, H. Nakane, K. Tanaka, and G. Tanaka, Effectiveness of Earmuffs and Noise-cancelling Headphones for Coping with Hyper-reactivity to Auditory Stimuli in Children with Autism Spectrum Disorder: A Preliminary Study. *Hong Kong Journal of Occupational Therapy*, 2016. 28: p. 24-32.
- [19] Cook, A., C. Johnson, and S. Bradley-Johnson, White noise to decrease problem behaviors in the classroom for a child with attention deficit hyperactivity disorder (ADHD). *Child & Family Behavior Therapy*, 2015. 37(1): p. 38-50.
- [20] Pasut, W., H. Zhang, E. Arens, S. Kaam, and Y. Zhai, Effect of a heated and cooled office chair on thermal comfort. *HVAC&R Research*, 2013. 19(5): p. 574-583.
- [21] Taub, M., H. Zhang, E. Arens, F. Bauman, D. Dickerhoff, M. Fountain, W. Pasut, D. Fannon, Y. Zhai, and M. Pigman, The use of footwarmers in offices for thermal comfort and energy savings in winter. 2015.
- [22] Melikov, A.K., M. Skwarczynski, J. Kaczmarczyk, and J. Zabecky, Use of personalized ventilation for improving health, comfort, and performance at high room temperature and humidity. *Indoor Air*, 2013. 23(3): p. 250-263.
- [23] Yamakawa, K., K. Watabe, M. Inanuma, K. Sakata, and H. Takeda, A study on the practical use of a task and ambient lighting system in an office. *Journal of Light & Visual Environment*, 2000. 24(2): p. 15-18.
- [24] CATT. CATT-Acoustic™ v9.1 powered by TUCT™ v2. 2019 [cited 2018 Aug 2018]; Available from: www.catt.se.

- [25] Bluysen, P.M., F. van Zeist, S. Kurvers, M. Tenpierik, S. Pont, B. Wolters, L. van Hulst, and D. Meertins, The creation of SenseLab: a laboratory for testing and experiencing single and combinations of indoor environmental conditions. *Intelligent Buildings International*, 2018. 10(1): p. 5-18..
- [26] Cox, T. and P. d'Antonio, Acoustic absorbers and diffusers: theory, design and application. 2016: Crc Press.
- [27] Acoustic Project Company. ABSORPTION COEFFICIENTS. [cited 2018; Available from: http://www.acoustic.ua/st/web_absorption_data_eng.pdf.
- [28] Lombard, E., Le signe de l'elevation de la voix. *Ann. Mal. de L'Oreille et du Larynx*, 1911: p. 101-119.
- [29] Nijs, L., K. Saher, and D. den Ouden, Effect of room absorption on human vocal output in multitalker situations. *The Journal of the Acoustical Society of America*, 2008. 123(2): p. 803-813.
- [30] Rindel, J.H., Verbal communication and noise in eating establishments. *Applied Acoustics*, 2010. 71(12): p. 1156-1161.
- [31] Lazarus, H., New methods for describing and assessing direct speech communication under disturbing conditions. *Environment International*, 1990. 16(4-6): p. 373-392.
- [32] de Ruiter, E.P.J. Lombard effect, speech communication and the design of large (public) spaces. in *Forum Acusticum*. 2011.
- [33] Delft University of Technology. The model for the lombard effect compared to literature data. Available from: https://bk.nijsnet.com/O226030_TH34_Lombardliteratuur.aspx.
- [34] Whitlock, J. and G. Dodd, Classroom acoustics—controlling the cafe effect... is the Lombard effect the key. *Proceedings of ACOUSTICS, Christchurch, New Zealand*, 2006: p. 20-22.
- [35] Bistafa, S.R. and J.S. Bradley, Predicting reverberation times in a simulated classroom. *The Journal of the Acoustical Society of America*, 2000. 108(4): p. 1721-1731.
- [36] Hansen, C.H., Fundamentals of acoustics. Occupational Exposure to Noise: Evaluation, Prevention and Control. *World Health Organization*, 2001: p. 23-52.

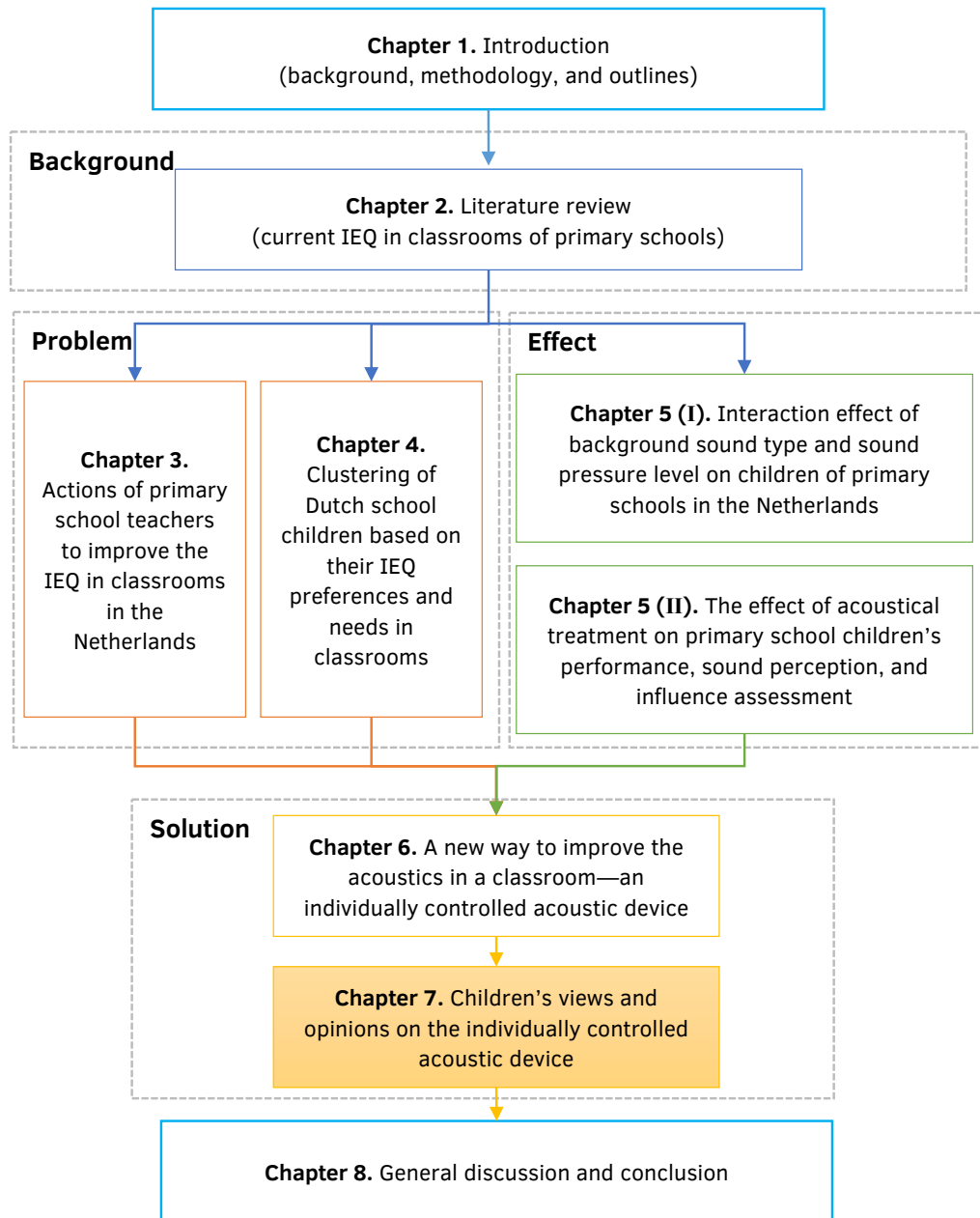

7 A child-centred experiment to test a new individually controlled acoustic improvement device

In recent years, individual control has raised attention in the IEQ field because of its considerable potential to increase occupants' satisfaction and performance. However, compared with that given to the use of individually controlled devices (ICDs) in office buildings, the application of these devices in primary schools does not receive enough deserved attention. Currently, almost all the ICDs are designed for adults. This study, therefore, designed an individually controlled acoustic improvement device (ICAID) for children, and the previous chapter proved its effectiveness. What, then, is children's opinion about it? This chapter presents a test of the usability of the ICAID in the SenseLab with primary school children. The results of this experiment show that most children believe that it is necessary to reduce noise in their classroom, and the ICAID can achieve that goal.

This chapter is based upon the following article: Zhang, D., Tenpierik, M., & Bluysen, P. M. (2020). A child-centred experiment to test a new individually controlled acoustic improvement device. *Under review (Indoor and Built Environment)*.

ABSTRACT In a previous simulation-based study, individually controlled noise-reducing devices (ICND) proved to be an effective way to improve classroom acoustics. In the current study, one type of ICND was designed, prototyped and tested. This device looks like a canopy hanging above a desk. It has two modes, i.e. open and closed, and can be easily changed by a remote controller. With this prototype, school children can control their local acoustic environment by themselves. This paper mainly describes an experiment to test a prototype of this ICND with more than 200 primary school children in the acoustics test chamber of the SenseLab. Apart from the experiment, preliminary simulations and measurements were carried out to further identify the functionalities of this device. Descriptive analysis, relationship analysis and content analysis were used to analyse the data received from the school children. The results showed that 83% of the children liked this device and 61% of them wanted to have it in their own classroom. The measurement and simulation results also showed a positive effect of this device on local room acoustics. However, since this is a prototype, improvements are required. Based on the children's feedback, this study summarizes suggestions for future modifications.

KEYWORDS **Keywords:** noise reduction; individual control; primary school classrooms; user experience; sound strength G

7.1 Introduction

In recent decades, noise perceived in classrooms of primary schools has drawn worldwide attention. According to an investigation conducted among 1145 Dutch primary school children, noise was reported to be the biggest indoor environmental problem in primary school classrooms [1], and the sound generated from children themselves and their classmates was described to be the main noise source [1-3]. Poor acoustics in classrooms has also been observed in Brazil, where the teachers and children reported noise created in their neighbouring classrooms as the main source of annoyance [4]. In the United States, inferior acoustics in classrooms is also a common problem. Seep et al. [5] found that the speech intelligibility rating in many American classrooms was 75% or less due to excessive noise, which means that students with normal hearing on average missed one word among every four spoken words in these classrooms.

Apart from the research on perceived sound, many studies have been conducted including objective acoustic measurements in classrooms [4, 6, 7]. Unfortunately,

the measured acoustical quality in most studies rarely reached the standards set for primary schools around the world. For example, in a study conducted in 26 classrooms of seven schools in Medellin, Colombia, none of these classrooms met the related acoustic requirements [8]. A survey of acoustic conditions of unoccupied classrooms in Canada demonstrated that even in most of the newly renovated classrooms, the background noise level and reverberation time (RT) could not meet the standard [9]; and in the United States, a study on the acoustics of classrooms showed that the ambient noise level in only one among the 16 tested classrooms met the national standard [10].

Since hearing and understanding verbal information is important for a good learning process, many researchers began to pay attention to the observed poor acoustics of classrooms. Therefore, the impact of poor acoustics on school children have been well studied [11-14]. An experimental investigation conducted by Valente et al. showed that excessive noise and a too long reverberation time could impair speech intelligibility and, therefore, has a negative effect on children's learning performance [15]. Similar results have been found by Klatte et al. [11], who identified the relationship between perceived noise in classrooms and children's poor performance in verbal tasks. They demonstrated that the long-term exposure to noise may have adverse impact on children's cognitive development. Moreover, in primary schools, the speech perception of younger children is more affected by noise than with older children [16].

Considering the poor acoustics in classrooms and its impact on school children, it is urgent and important to find a way to reduce noise that improves the acoustical quality of classrooms. To do so, in the past decades, many schools have been renovated by adding sound absorption ceiling (and/or wall) panels. As a common acoustic-improving method, adding acoustic panels demonstrated to be useful in some studies [17-19]. However, in recent studies this conventional method showed to be not effective enough. In a study of the renovation of a children's playground, Chmelik et al. concluded that the influence of roof materials on the sound pressure level (SPL) around the playground area was very low [20]. Also, in a field study conducted in 21 primary schools in the Netherlands, the children were bothered by noise even though almost all of the investigated classrooms had sound absorbing ceilings [1]. For those classrooms it can be concluded that a more effective noise-reducing solution is needed.

The acoustics of a classroom is difficult to assess by simply using average values for the whole classroom because there is much variation in children's sound perceptions and speech intelligibility scores under the same acoustical conditions [12, 16, 21]. Therefore, it makes more sense to assess the acoustics individually. Additionally,

Zhang et al. [22] also found that children are different from each other in terms of their IEQ needs and preferences, some being more sensitive to noise than others. Thus, they suggested to apply individually controlled devices for each child to improve the learning environment. A recent simulation study conducted by the same team, proved an individually controlled noise-reducing device (ICND) to be a better solution than an absorbing ceiling [23]. Therefore, as follow-up research, the present study designed and prototyped such an ICND for primary school children and tested it with more than 200 school children. Moreover, measurements and simulations of the sound strength G in a test chamber were also carried out to further indicate the effect of the ICND on the acoustics.

7.2 Method

In general, this study involved two different types of tests to demonstrate the effectiveness of the ICND: one is a subjective test (with children) by means of a user-centred experiment, which tests the usability of the device; while the other is an objective test (without children) including measurements and simulations, which test the SPL reduction effect of the device.

7.2.1 Experimental design

The experiment was carried out during Dutch school holidays between the 20th of August and the 27th of October, in the acoustics chamber of the SenseLab [24] located in the Science Centre Delft, The Netherlands. In total, there were 25 test days, including 8 days during the summer holidays, 8 days during weekends, and 9 days during the autumn holidays. More than 300 visitors, including children and adults, participated in the experiment and 274 of them completed the questionnaire. All participants were normal visitors of the Science Centre Delft and their involvement in this experiment was on a voluntary basis. As one of the normal programmes of the Science Centre, this experiment was conducted during three sequences on a test day, each of which lasted around 40 minutes: 12:00-12:40, 14:00-14:40 and 16:00-16:40.

Test chamber setup

The acoustics test chamber is a rectangular room of circa 2.5 m (l) × 2.3 m (w) × 2.1 m (h). In this chamber, two identical ICNDs were installed above two sets of school desks and chairs (see Figure 7.1). The ICNDs could be controlled by a remote controller with three buttons, corresponding to “open”, “closed” and “pause” (which was not used in this experiment). During the experiment, children could open or close the device by pressing one of these buttons. Moreover, as can be seen in Figure 7.1, on the back wall, two information letters (one in Dutch; one in English) and two posters (one in Dutch; one in English) explained the reasons for the design of this device and showed the safety instructions (e.g., do not touch the device). This information helped participants to better understand and complete the experiment.



FIG. 7.1 The layout in the test chamber.

Test procedure

Before participants came into the test chamber, a researcher first introduced them to the purpose of the experiment and its procedure, and then gave them a double-sided, one-page questionnaire and a remote controller. Two children could test the ICNDs at the same time. During the testing time, children had around 3 minutes to experience the device and were free to talk with each other, created noise, and could open or close the device at any time. No extra artificial noise was played during the test, all the noise was generated through children's talking, moving chairs, and clicking pens, just like what they usually do in their classrooms. After this experience, they were given another 3 minutes to complete the questionnaire. On average, the whole procedure took around 7 minutes. During the test, at least one researcher waited outside the chamber, so that the participants could ask questions whenever necessary. Additionally, since this was a voluntary experiment, participants could skip any questions or even leave the chamber at any moment.

Device design

A prototype of the ICND was designed and prototyped as shown in Figure 7.2. This device consisted of one main (fixed, horizontal) panel and six (movable) side panels, all comprised of one MDF (medium-density fibreboard) inner and two outer layers of acoustic foams with an average thickness of 30 mm. The main panel is a hexagon, and each side panel consists of two trapezoids connected under an angle of 171° (see Figure 7.2). These sizes were based on the real size of education furniture in the Netherlands. These six side panels were connected to a linear motor (the blue part on top of the hexagon in Figure 7.2) with steel cables (the blue lines in Figure 7.2), and to make the cables move smoothly, six wheels were placed at the middle of each edge of the main panel. The whole prototype weights around 2 kg. As shown in Figure 7.2, it has two modes: open (Figure 7.2 b) and closed (Figure 7.2 a), which can be changed easily using a remote controller with two push buttons. The depth of the closed ICND, namely the vertical distance between the edge of the main panel and the edge of the side panels, was 163 mm. A short manual for the use of the remote controller was placed on top of the desk during the test. The cost of making this prototype was around 80 Euros.

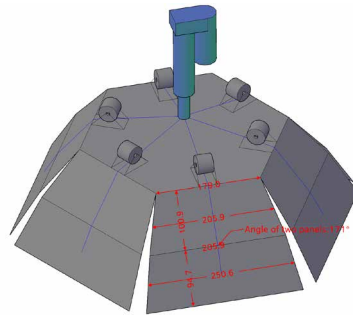

a) close

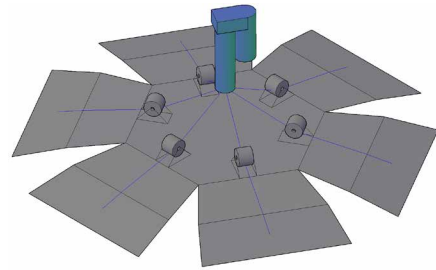



b) open

FIG. 7.2 The schematic diagram of the ICND.

Questionnaire design

2. Is this device able to create a quiet learning environment?

Yes, it works very well 

Yes, it works 

No, it doesn't work 

I don't know

4. What is the impact of this device on your school performance?

Good impact 

No impact 

Bad impact 

I don't know

5. Do you think the device is easy to use?

Yes 

I don't know 

No 

FIG. 7.3 Examples of icons added to the questionnaire to increase understandability.

The questionnaire contained three parts: a brief introduction, 5 questions about personal information and 9 questions about feedback on the ICND (see Appendix 7.A). The introduction ended with a short permission letter to ask the parents' permission to allow their child to take part in the test. To make the questions easier to understand for children, several icons were added to some questions (see Figure 7.3).

7.2.2 Data Analysis

All data from the questionnaires were manually typed and stored into a digital database, and then analysed using SPSS version 23.0 (SPSS Inc. Chicago, IL, USA). Three data analysis methods were used in this study, namely descriptive analysis, relationship analysis and content analysis.

First, all general information of the participants, such as their age and gender, were analysed using descriptive analysis. Additionally, this analysis was also applied to all the device-related questions to get a general understanding of the children's opinion on this device. Next, to identify the reason why children liked or wanted to have this device, a Chi-squared test was used to analyse the relationships between these two questions and the five previous questions that were about the usability and functionality of the device. Lastly, content analysis was used to sort out children's various answers on three open questions, i.e. the reason why they liked/disliked the device, the reason why the device was wanted/not wanted, and their suggestions for improvement. Before this analysis, all the children's written answers were coded into several different categories based on keywords and main ideas.

7.2.3 Measurements

As a further proof of the functioning of the ICND, room acoustics measurements were also carried out in the same test chamber for five different settings, including one control setting and four testing settings (four open/closed combinations of two ICNDs). The measuring equipment included:

- an omni-directional speaker (Norsonic Nor276);
- a power amplifier (Norsonic Nor280);
- a sound analyser (Norsonic Nor140) as microphone;
- a Behringer UCA222 audio interface;
- and a laptop.



FIG. 7.4 The setting inside (left) and outside the test chamber [27] during the measurement.

The speaker was placed 1.1 m above the floor and the microphone 1.2 m above the floor, according to the average heights of ears and mouths of seated Dutch children (aged 8-12 years). During the measurement, no one was inside the room; the procedure was controlled from a laptop placed outside the room (see Figure 7.4). Logarithmic sweep signals were generated by the laptop and played through the speaker. The microphone received and recorded the sound signal and transferred it to the laptop. Then the signal was analysed using a custom-made MATLAB script on the laptop. For each measurement, 4 sweeps were generated, and the incoming signals averaged. Regression analysis was used to calculate the most important room acoustics variables.

Since the test chamber is too small to generate a diffuse (statistical) sound field, the RT could hardly be accurately measured in this study. Also, the speech transmission index (STI) might not be an interesting parameter in this case because the small distance between source and receiver always leads to a high STI. Furthermore, the SPL or its relative counterpart “strength of sound G” was found to be a valid indicator of perceived loudness and annoyance [25, 26], and a reduction of SPL/G is one of the most important goals the ICNDs need to achieve. Therefore, taking all these points into account, this study just focuses on the measured results of the “strength of sound G”. It should be noted that during the measurements, there were no desks and chairs inside the test chamber because the limited space was occupied by the measuring equipments.

7.2.4 Simulation

Finally, a series of room acoustics simulations were performed with Computer Aided Theatre Technique (CATT-Acoustic™), which is a ray-tracing-based room acoustics prediction software. The size and layout of the simulated room was exactly the same as the experiment room. The source and receiver were set under the ICND in both the simulations and the measurements, because according to the results reported by Dutch primary school children, the main noise source in their classrooms is the sound created by their classmates. Similar to the measurement, the simulations were also run for the same four situations (see Figure 7.4).

In terms of the absorption and scattering coefficients of materials, some of them, such as the walls of the chamber and the furniture, were found from the literature, while for the material used to build the ICND, its absorption coefficients were measured using a two-microphone impedance tube measurement and the results were shown in Table 7.1. With respect to the prediction method, the ray-tracing type ‘Predict S×R’ was used in this study because of its advanced algorithms; ‘Longer calculation with detailed auralization’ was selected as the ‘Algorithm’ because of its more advanced prediction; ‘Number of rays’ and ‘Echogram length’ were set to ‘auto’; the air absorption was estimated by the software; and the diffraction caused by the edge source was also included in this simulation.

TABLE 7.1 Absorption and scattering coefficients of different materials.

	125 HZ	250 HZ	500 HZ	1k HZ	2k HZ	4k HZ
ICND	0.05	0.07	0.11	0.21	0.41	0.67
	<i>0.10</i>	<i>0.10</i>	<i>0.10</i>	<i>0.10</i>	<i>0.10</i>	<i>0.10</i>
Surfaces	0.10	0.08	0.04	0.04	0.05	0.01
	<i>0.10</i>	<i>0.10</i>	<i>0.10</i>	<i>0.10</i>	<i>0.10</i>	<i>0.10</i>
Furniture	0.02	0.02	0.02	0.02	0.04	0.03
	<i>0.10</i>	<i>0.10</i>	<i>0.10</i>	<i>0.10</i>	<i>0.10</i>	<i>0.10</i>

Note: All the upright values are the absorption coefficients, and all the italic values are the scatter coefficients.

In total, six different settings were simulated, including the two control settings (without and with furniture) and four testing settings (see Figure 7.5). The layout of the control without furniture setting was the same as the control setting in the measurement. Therefore, the comparison of these two results could be considered as the validation of the simulation method. Concerning the other settings with the furniture, they were the same as the real settings used in the experiment and in the real classroom. Therefore, these results could provide more information about the function of the ICNDs in the real situations. The positions of the sources and

receivers in these simulations were kept the same in all settings: one source at a height of 1.1 m and one receiver at a height of 1.2 m; the distance between the source and the receiver was 1.2 m; and both of them were set below the ICNDs (see Figure 7.5). Only one difference should be noted: the source in the control without furniture setting was omni-directional, which was the same as for the measurements. While in the other settings, the source was a speaking person facing the receiver.

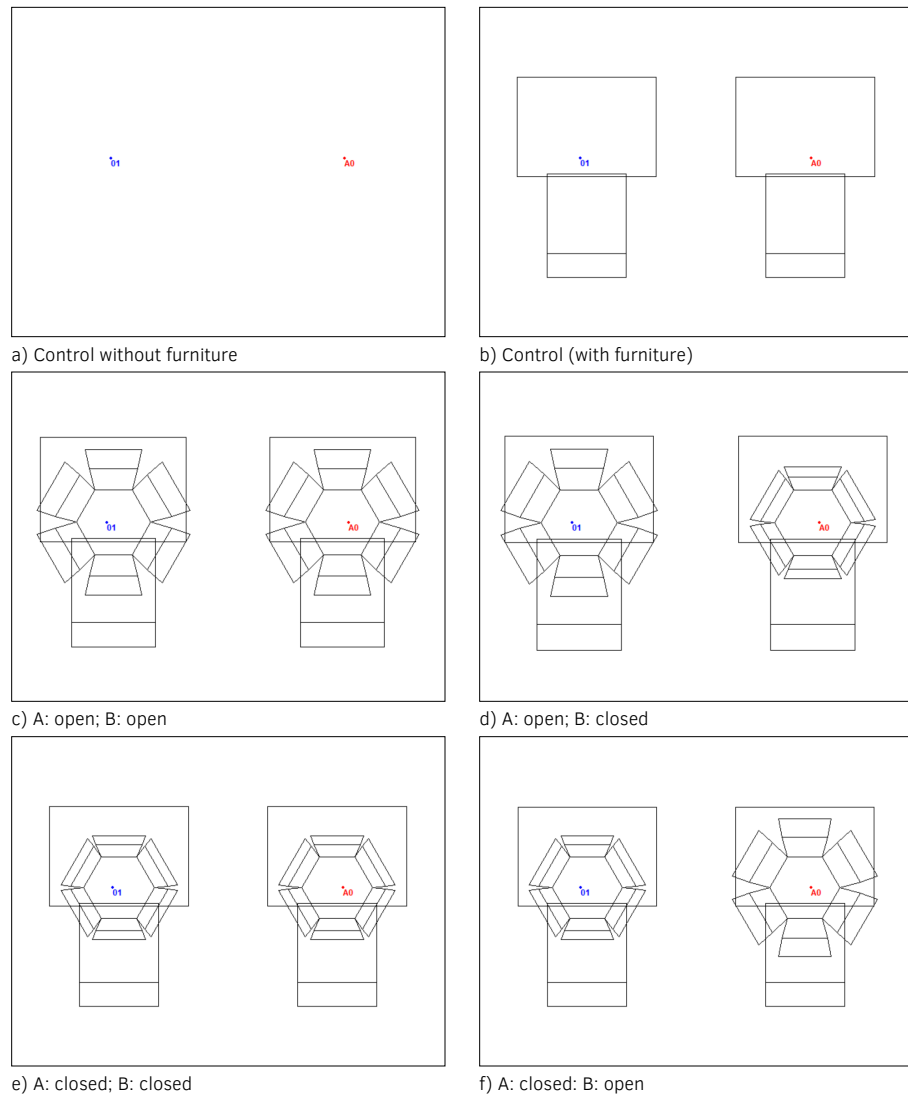

FIG. 7.5 The layout of the simulated room and the positions of the source (A0) and receiver (O1).

7.2.5 Ethical aspects

Before the experiment, all the parents or supervisors of the participating children were asked for their consent by signing an approval form. Moreover, the participants could skip any question or step out of the experiment at any time if they wanted. The Ethics committee of the TU Delft gave approval for the study.

7.3 Results

7.3.1 Participants

In total, 274 participants participated and completed the questionnaire during the 25 test days. Among them, 17 people were excluded from the analysis because of a hearing problem, and eight people were excluded because they answered less than half (four out of eight) of the device-related questions. Besides, the participants whose age was not between 5-13 (Dutch primary school children age range), and/or whose schools were not in the Netherlands, were excluded. After the filtering, 201 participants, including 95 girls and 106 boys, were left. The average age of these participants was 9.5 (SD 1.9) years old.

7.3.2 Descriptive analysis results

Children's feedback on the device was collected by asking them questions such as: "Is this device able to create a quiet learning environment?", "What is the impact of this device on your school performance?", "Do you think this device is easy to use?" (see Table 7.2). For the first three questions, all the affirmative answers were combined - for example, "yes, it works" and "yes, it works very well" were combined as "yes, it works" -, while all the other answers were kept in their original version. All the device-related questions were classified into three categories: questions 1-5 were about the functionality and usability of the device; questions 6 and 7 were about the overall impression of the device; and question 8 was about the imaginary user behaviour.

The results of the descriptive analysis, except for the open questions, are shown in Table 7.2. For questions 1-5, the values in parentheses show the results excluding the answer “I do not know”.

TABLE 7.2 Result of the descriptive analysis.

Questions	%
1. Is it necessary to reduce noise in classrooms?	75.6 (86.4)
Yes, it is necessary	11.9 (13.6)
No, it is not necessary	12.4
I do not know	
2. Is this device able to create a quiet learning environment?	49.4 (70.4)
Yes, it is	20.7 (29.6)
No, it is not	29.9
I do not know	
3. Will reduction of noise help you with your school performance?	75.0 (91.5)
Yes, it will	70.0 (8.5)
No, it will not	18.0
I do not know	
4. What will the impact of this device be on your school performance?	35.5 (64.1)
Good impact	15.1 (27.2)
No impact	4.8 (8.7)
Bad impact	44.6
I do not know	
5. Do you think the device is easy to use?	81.9 (94.2)
Yes	5.0 (5.8)
No	13.1
I do not know	
6. Do you like the device?	82.8
Yes	17.2
No	
7. Would you like to have one in your classroom?	61.3
Yes	38.7
No	
8. If you have one in your classroom, how often will you change its mode?	55.6
Several times a day	21.2
Once or twice per day	3.2
Less than once a day	20.1
Almost never	

Note: the numbers in the parentheses mean the results obtained excluding “I do not know”.

In general, all the answers were quite positive. For the overall impression, 83% of the participants liked this device and 61% of them wanted to have one in their classroom. With respect to the acoustical quality in their classrooms, 76% of the children thought it was necessary to reduce noise and 49% (70%, excluding “I do not know” answers) thought this device could create a quiet learning environment. Concerning their performance evaluation, 75% of the participants thought reducing noise could benefit their school performance and 36% (64%, excluding “I do not know” answers) of them thought this device would have a good impact on their performance. And in terms of the usability, 82% (94%, excluding “I do not know” answers) thought this device was easy to use, and if they had one, 56% would change its mode several times a day.

7.3.3 Relationship analysis results

Considering that questions 1-5 were about the functionality and usability of the device, which could be regarded as the reasons for why the participants liked or wanted to have the device (questions 6 and 7), it is interesting to test whether there is a relationship between them. Table 7.3 shows the results of the chi-squared analysis between questions 1-5 and questions 6-7. There are statistically significant relationships between these questions, except for the relationship between “It is necessary to reduce noise in classrooms” and “I like the device”. Moreover, the standardized residuals showed that children who liked the device somewhat more frequently, were of the opinion that “reducing noise contributes to good performance”, “this device is able to create a quiet learning environment and is easy to use”, and “it will have a good impact on performance”. Similarly, the standardized residuals also showed that children who wanted to have this device more frequently, found that “it’s necessary to reduce noise in classrooms”, “reducing noise contributes to good performance”, “this device is able to create a quiet environment and is easy to use”, and “it will have a good impact on performance”.

TABLE 7.3 Result of the Chi-squared analysis between the questions.

	I like the device. χ^2 (p)	I want to have one in classrooms. χ^2 (p)
It is necessary to reduce noise in classrooms.	1.60 (0.659)	17.17 (0.001)
This device is able to create a quiet learning environment.	24.18 (<0.001)	29.02 (<0.001)
Reducing noise contribute to good school performance.	21.68 (<0.001)	21.76 (<0.001)
The device has a good impact on school performance.	11.80 (0.008)	31.50 (<0.001)
This device is easy to use.	37.81 (<0.001)	30.73 (<0.001)

Furthermore, this study also analysed the relationship between whether the participants liked the device and whether they wanted to have it. The results showed that a statistically significant relationship did exist between these questions ($\chi^2(2) = 26.95$, $p < 0.001$). The standardized residuals indicated that the participants who liked the device inclined to wanted to have it in their classroom. This relationship did make sense: usually when one likes something, one is more eager to want it, and to some extent, the existence of this relationship between these questions might imply the reliability and logicity of children's answers.

7.3.4 Content analysis results

To further understand the children's opinion on this device, this study used content analysis to qualify the presence, meaning and relationships of the children's answers to the three open questions. For each question, several short sentences summarized the children's original answers. Next, these sentences were classified into three categories (appearance, functionality, and usability) complying with the three emphases that users have when they buy products [28]. Six experienced researchers were individually asked to group all these sentences into the three categories and the most frequent categorisation was further used in this study. The interrater reliability was checked using the kappa score, which was higher than 0.4 [21], indicating a strong agreement among these researchers. Based on that outcome, the classifications presented in this paper could be considered reliabl.

Open question 1: Why do/don't you like the device

In total, 124 out of 164 children who liked this device and 21 out of 34 children who did not like this device wrote down the legible reason why they had such an impression. For those who liked it, two, four, and two subcategories were identified under the categories of appearance, usability and functionality. While for those who didn't like it, only one subcategory under each category was identified (see Figure 7.6).

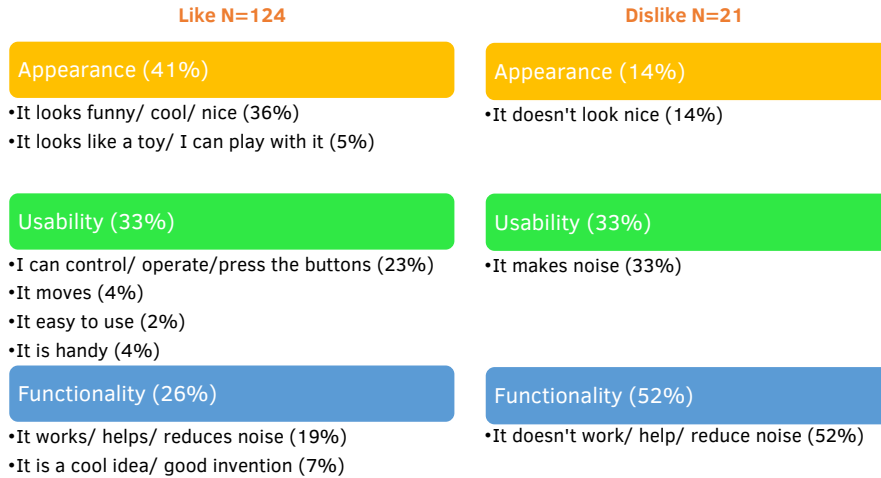

FIG. 7.6 The classification of subcategories based on the “like/dislike” question.

Figure 7.6 indicates that the reason why many children liked this device was almost evenly distributed into these three categories, with appearance as a slightly more important reason. While the reason why some children disliked it, was mainly because of its insufficient expected functioning.

Open question 2: Why do/don't you want to have this device in your classroom?

For this question, 82 out of 117 children who wanted to have this device and 51 out of 74 children who didn't want to have the device gave their clear reasons. According to the content of their answers, the subcategories were classified and presented in Figure 7.7.

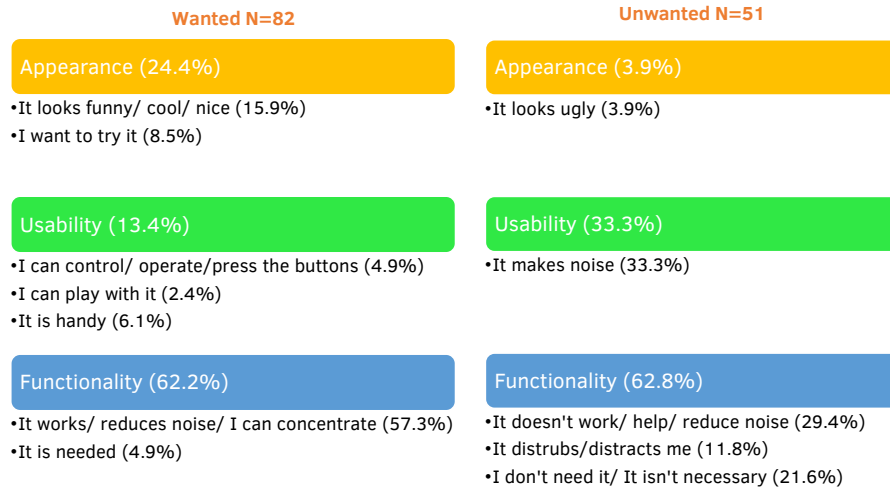

FIG. 7.7 The classification of subcategories based on the "wanted/unwanted" question.

It is interesting to see that the reason why children wanted to have this device was mainly because of its expected functioning. Most of the children who wanted to have it thought it worked/ helped/ reduced noise. Likewise, functionality was also the main reason why some children did not want to have it. So, functionality seems to be the key factor for children to decide whether they want to have this device or not.

Open question 3: How do you want to improve this device?

With respect to suggestions for improvement, 121 children expressed their ideas clearly, and 10 of them mentioned more than one idea. Therefore, 131 ideas were collected, and according to the content of these ideas, the subcategories were classified and presented in Figure 8. As can be seen, the children's suggestions were mainly focused on the usability. Most of the children wanted to make it lower and closer to their ears. Furthermore, many children reported that they preferred the linear motor to make less noise.

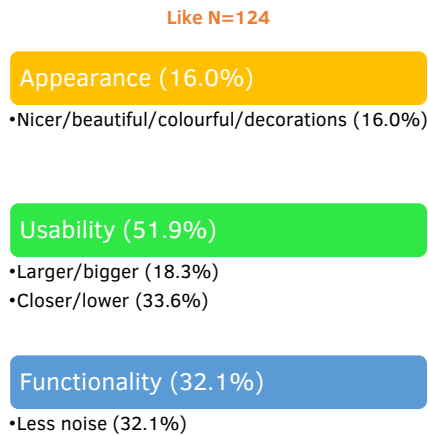

FIG. 7.8 The classification of subcategories based on the “improvement suggestions”.

7.3.5 Measurements

The G-value reflects the sound pressure level measured inside the room relative to the sound pressure level that would be obtained by the same source in an anechoic chamber at 10 m distance; a higher value indicates a louder sound level. As shown in Table 7.4, compared with the control setting, the average G-values (over the 250 to 2000 Hz octave bands) were 1.4 to 1.8 dB lower in the settings with ICNDs. The most important reason is the sound absorption material that is added to the room by the ICNDs.

Among the four ICNDs settings, the G-value was the lowest in the setting with two closed devices and it was the highest in the setting with two opened devices. This means that in the situation where a child is talking in a room equipped with such

closed devices, then this child's neighbour could be a little less bothered. However, the differences among the settings were smaller than 0.4 dB which means that they were much smaller than the just noticeable difference (JND) for sound pressure level (1 dB), the reasons being largely that the amount of sound absorption material was the same in all of these settings. So, the small difference might only be caused by the shielding of the ICNDs and edge diffraction. It is worth mentioning that because of the absence of the furniture, the reflection from the desks was lost during the measurements. Therefore, the measured SPLs were most likely lower than the SPLs perceived in the experiment.

TABLE 7.4 The measurement results (no tables and desks).

G	125	250	500	1k	2k	4k	average (125-4k)
Control	32.9	32.2	34.2	32.1	34.8	35.1	33.3
A open; B open	33.2	31.9	33.1	30.6	31.9	30.2	31.9
A open; B closed	33.3	31.8	33.0	30.1	31.7	30.4	31.7
A closed; B closed	33.4	31.8	32.8	29.9	31.5	30.3	31.5
A closed; B open	33.4	31.9	32.8	30.2	31.6	30.1	31.6

7.3.6 Simulations

Table 7.5 shows the simulation results. Similar to the measurements, only G was used in this study. The first simulated setting, i.e. control without furniture, was the same as the first measured situation, and the difference between the results obtained from the simulation and the measurement was within the limit of the JND. The similar results indicate that the simulation method could be considered as accurate and valid.

Given that there are desks and chairs in the testing chamber during the experiment and in real classrooms as well, only the results obtained from the simulations including the furniture were used. This might be shown in Table 5, the G-value in the control (with furniture) setting was higher than in the control without furniture setting, which can be explained by the sound reflection of the furniture surfaces. A comparison among the settings with furniture showed that the loudness was reduced in the settings with the devices, no matter whether they were opened or closed; and G was marginally lowest in the situation where both ICNDs were closed. However, the difference between these settings was even less obvious than in the measurement results, which might be also due to the sound reflection of the furniture.

TABLE 7.5 The simulation results

G (dB)	125	250	500	1k	2k	4k	average (250-2k)
<i>Control without furniture</i>	30.9	32.0	35.2	35.2	34.1	38.5	34.1
Control	32.2	33.3	36.0	36.1	35.1	39.0	35.1
A open; B open	32.2	33.5	35.6	35.2	33.9	35.4	34.5
A open; B closed	32.1	33.2	35.5	35.3	33.9	35.4	34.5
A closed; B closed	32.2	32.9	35.6	35.2	33.7	35.4	34.4
A closed; B open	32.1	33.1	35.6	35.2	33.9	35.4	34.5

7.4 Discussion

7.4.1 Acoustic problem in classrooms

The analysis results of the questions related to the acoustics in classrooms revealed a poor acoustical quality in Dutch primary schools: 76% of the children thought it necessary to reduce the noise in their classrooms and 75% thought they would have a better performance if their learning environment was quieter. This confirms the results reported by a previous field study which showed that most children were bothered by noise in their classrooms and reported that “hearing teacher” and “indoor sounds” were two important factors that could have an impact on their performance [22]. Even though many classrooms did have absorbing ceiling panels, the acoustics still seemed not good enough to provide a quiet learning environment [1]. The study reported here confirmed the importance of the need of providing more effective acoustic treatment.

7.4.2 Feedback from children

201 completed questionnaires were analysed. The relationships between the answers to different questions implied that the children’s answers were consistent and reliable [23]. Generally speaking, their feedback on the ICNDs was positive, most of them liking it and wanting to have one in their classroom. The relationship between

these two questions and other questions indicated that the reason why children liked the device and wanted to have it, is that they believed this device is able to reduce noise and therefore will have a good impact on their school performance. Furthermore, the content analysis of the open questions studied the direct reasons of the children's preference. They liked this device mainly because it looked funny/cool, and they wanted to have it mainly because it worked/helped/reduced noise. In terms of the negative feedback, the reason why some children did not like the device or did not want to have it was mainly because they thought this device did not work for them or because this device itself also made noise. Indeed, the linear motor of this device made noise when it moved, which is contrary to its design purpose for reducing noise. Therefore, this might be the reason why many children suggested to reduce the noise created by the device.

7.4.3 Effect of the ICND on room acoustics

Apart from the perceived impact of the ICND, the measurement and simulation results demonstrated its quantifiable impact on room acoustics. In the measurements and simulations, the loudness of sound at the position of a child's seat was tested, while assuming that the neighbour is talking. Since in several studies [1, 24] classmates were mostly pointed out as the main sources of noise in classrooms, the settings of the sound source and receiver in the simulations and measurements were considered to be acceptable. Compared with the room without the ICNDs, a noticeable reduction of the loudness of sound was found at the child's seat in the room with the ICNDs, whereas there was not much difference between the four settings with different open/ closed combinations of the two devices. A possible reason for this might be that in the testing chamber the distance between the sound source and receiver was quite small, and the direct sound was dominant in this situation. So, the difference caused by changing the modes of the devices could hardly be noticed. However, real classrooms are much larger than the testing chamber and the distance between the sound source and receiver will most likely be larger than the reverberation radius. Therefore, the reverberant field will be dominant, and in this context, the ICNDs are expected to work more effectively in real classrooms, resulting in a bigger effect.

7.4.4 Application potential of ICNDs in real classrooms

In a previous study the effect of ICNDs on acoustics in a classroom was simulated by means of CATT-Acoustic™ [25]. The results showed that the ICNDs worked better than the addition of acoustical ceiling panels (the conventional used method), in terms of lowering RT, increasing speech transmission index, and the reduction of noise. This simulation study provided the theoretical basis of applying ICNDs in classrooms. Additionally, in the underlying study a prototype was built and tested with school children. The positive responses from the participating children further demonstrated the application potential of the ICNDs. However, as mentioned in section 4.3, the limited size of the test chamber affected the performance of the ICNDs. In a real classroom, the effect of the ICNDs on the acoustics should, therefore, theoretically be better.

7.4.5 Possible improvement of the current device

According to the children's feedback in this study and the results reported in previous studies [21], an ICND may be a possible solution for children to control their individual acoustical environment. However, in this study it was seen that there are still some problems with the device designed and tested, such as the noise produced by the linear motor during operation and its boring appearance. The suggested improvements by the children were mainly focused on reducing this noise and changing its height. Many children suggested to lower the height of the device. However, a too low height might cause accidents, such as children bumping their heads against it. Therefore, a better solution might be to change the moving pattern from open/closed to up/down. There are several possibilities to do this, for example, by changing the motor or using a mechanical method (e.g. a rope), which could also reduce the noise created by the device. All these possible improvements might be put into practice in future studies.

Apart from the children's suggestions, the noise-reducing effect of this device could also be further improved. In this context, increasing the thickness of the acoustical foam layer of the device might be an effective and feasible method. For example, if the thickness of the acoustic foam layer increases from 30 mm to 50 mm, then the simulated noise-reducing effect will be improved from 0.7 dB to 2.3 dB (See Appendix B).

7.4.6 Limitations and future studies

Two potential limitations can be put forward. The first one is about the measurements and simulations. Due to the size limitation of the test chamber, the measurement of RT is likely to be inaccurate, therefore only one parameter – Strength G – was shown to demonstrate the acoustic improvement by the devices. The second one concerns the questionnaire survey. Several questions considered children’s future experiences in their classrooms. Children had to answer these questions based on their imagination, so many of them choose “I do not know”, which was honest but not useful for the study. These limitations suggest that future studies should test the device in a real classroom with school children that can assess the performance of the device.

7.5 Conclusion

In this study an individually controlled noise-reducing device (ICND) was designed and tested with more than 200 school children. Based on the outcome, it can be concluded that this ICND was very welcomed by the school children. They reported that the device would likely reduce noise and make them concentrate better. Additionally, the measurement and simulation results confirmed the noise-reducing ability of this device to some extent. Because there is still room for further improvement, new versions should be designed and developed, and further tests need to be performed with school children in the future. Still, this study demonstrated the potential of a hanging open/closed ICND to reduce noise produced by talking children in classrooms.

References

- [1] Bluysen, P.M., D. Zhang, S. Kurvers, M. Overtoom, and M. Ortiz-Sanchez, Self-reported health and comfort of school children in 54 classrooms of 21 Dutch school buildings. *Building and Environment*, 2018. 138: p. 106-123.
- [2] McAllister, A.M., L. Rantala, and V.I. Johnsdottir, The others are too loud! Children's experiences and thoughts related to voice, noise and communication in Nordic preschools. *Frontiers in psychology*, 2019. 10: p. 1954.
- [3] Brännström, K.J., E. Johansson, D. Vigertsson, D.J. Morris, B. Sahlén, and V. Lyberg-Åhlander, How children perceive the acoustic environment of their school. *Noise & health*, 2017. 19(87): p. 84.
- [4] Zannin, P.H.T. and C.R. Marcon, Objective and subjective evaluation of the acoustic comfort in classrooms. *Applied Ergonomics*, 2007. 38(5): p. 675-680.
- [5] Seep, B., R. Glosemeyer, E. Hulce, M. Linn, and P. Aydar, Classroom Acoustics: A Resource for Creating Learning Environments with Desirable Listening Conditions. ASA, Technical Committee on Architectural Acoustics and University of Kansas Architectural Engineering Program. 2000.
- [6] Mikulski, W. and J. Radosz, Acoustics of classrooms in primary schools—results of the reverberation time and the speech transmission index assessments in selected buildings. *Archives of Acoustics*, 2011. 36(4): p. 777-793.
- [7] Astolfi, A., G.E. Puglisi, S. Murgia, G. Minelli, F. Pellerey, A. Prato, and T. Sacco, The influence of classroom acoustics on noise disturbance and well-being for first graders. *Frontiers in Psychology*, 2019. 10: p. 2736.
- [8] Aguilar, J.R. and L.M. Tilano, Measurement of Classroom Acoustic Parameters in the Public Schools of Medellin. *INTERNATIONAL JOURNAL OF ACOUSTICS AND VIBRATION*, 2019. 24(1): p. 50-55.
- [9] Hadavi, S. and J. Lee, A Survey of The Unoccupied Acoustic Conditions of Active Learning Classrooms in Montreal. *Canadian Acoustics*, 2019. 47(1): p. 81-86.
- [10] Kvernstoen Rønholm and Associates INC, classroom acoustical study. 2007.US.
- [11] Klätte, M., K. Bergström, and T. Lachmann, Does noise affect learning? A short review on noise effects on cognitive performance in children. *Frontiers in psychology*, 2013. 4: p. 578.
- [12] Zhang, D., M. Tenpierik, and P.M. Bluysen, Interaction effect of background sound type and sound pressure level on children of primary schools in the Netherlands. *Applied Acoustics*, 2019. 154: p. 161-169.
- [13] Klätte, M., J. Spiłski, J. Mayerl, U. Möhler, T. Lachmann, and K. Bergström, Effects of aircraft noise on reading and quality of life in primary school children in Germany: Results from the NORAH study. *Environment and Behavior*, 2017. 49(4): p. 390-424.
- [14] Gheller, F., E. Lovo, A. Arsie, and R. Bovo, Classroom acoustics: Listening problems in children. *Building Acoustics*, 2019: p. 1351010X19886035.
- [15] Valente, D.L., H.M. Plevinsky, J.M. Franco, E.C. Heinrichs-Graham, and D.E. Lewis, Experimental investigation of the effects of the acoustical conditions in a simulated classroom on speech recognition and learning in children. *The Journal of the Acoustical Society of America*, 2012. 131(1): p. 232-246.
- [16] Bradley, J.S. and H. Sato, The intelligibility of speech in elementary school classrooms. *The Journal of the Acoustical Society of America*, 2008. 123(4): p. 2078-2086.
- [17] Mir, S.H. and A.A. Abdou, Investigation of sound-absorbing material configuration of a smart classroom utilizing computer modeling. *Building Acoustics*, 2005. 12(3): p. 175-188.
- [18] Siebein, G.W., M.A. Gold, G.W. Siebein, and M.G. Ermann, Ten ways to provide a high-quality acoustical environment in schools. *Language, speech, and hearing services in schools*, 2000. 31(4): p. 376-384.
- [19] Russo, D. and A. Ruggiero, Choice of the optimal acoustic design of a school classroom and experimental verification. *Applied Acoustics*, 2019. 146: p. 280-287.
- [20] Chmelik, V., J. Kuran, and M. Rychtarikova, Optimization of a membrane structure design for existing project of children's playground in the city of Krupina. in *TensiNet Symposium 2019, Softening the habitats, 3-5 June 2019*, Politecnico di Milano.
- [21] Zhang, D., M. Tenpierik, and P.M. Bluysen, The effect of acoustical treatment on primary school children's performance, sound perception, and influence assessment. in *E3S Web of Conferences*. 2019. EDP Sciences.
- [22] Zhang, D., M.A. Ortiz, and P.M. Bluysen, Clustering of Dutch school children based on their preferences and needs of the IEQ in classrooms. *Building and environment*, 2019. 147: p. 258-266.
- [23] Zhang, D., M. Tenpierik, and P.M. Bluysen, Individual control as a new way to improve classroom acoustics: a simulation-based study. *Applied Acoustics*, 2020 (under review).

- [24] Bluysen, P.M., F. van Zeist, S. Kurvers, M. Tenpierik, S. Pont, B. Wolters, L. van Hulst, and D. Meertins, The creation of SenseLab: a laboratory for testing and experiencing single and combinations of indoor environmental conditions. *Intelligent Buildings International*, 2018. 10(1): p. 5-18.
- [25] Beranek, L., The sound strength parameter G and its importance in evaluating and planning the acoustics of halls for music. *The Journal of the Acoustical Society of America*, 2011. 129(5): p. 3020-3026.
- [26] Nilsson, M.E., A-weighted sound pressure level as an indicator of short-term loudness or annoyance of road-traffic sound. *Journal of Sound Vibration*, 2007. 302(1-2): p. 197-207.
- [27] Duffy, J.F. and K.P. Wright Jr, Entrainment of the human circadian system by light. *Journal of biological rhythms*, 2005. 20(4): p. 326-338.
- [28] Nishizaki, Y., T. Doi, and T. Yamaoka, Which Design Seems Easy to Use? An Analysis of Individual Differences in Mental Models, in *Advances in Affective and Pleasurable Design*. 2017, Springer. p. 79-86.
- [29] Nichols, T.R., P.M. Wisner, G. Cripe, and L. Gulabchand, Putting the kappa statistic to use. *The Quality Assurance Journal*, 2010. 13(3-4): p. 57-61.
- [30] Morrison, J. Assessing Questionnaire Reliability. 2019; Available from: <https://select-statistics.co.uk/blog/assessing-questionnaire-reliability/>.

Appendix 7.A



Hello!

My name is Dadi Zhang, and I've designed an individually controlled device that could reduce classroom noise. I want to ask your help to test this device and then answer a few questions. These questions are about who you are and about your opinion about the new device. If something is not clear, you can always ask me.

If you think it is no problem that your answers will be used to improve this device, you can ask one of your parents or supervisors sign below, and after finish the questionnaire, please put it in the letterbox on the wall.

Yes, I give permission

Signature of parent / supervisor::

Date:

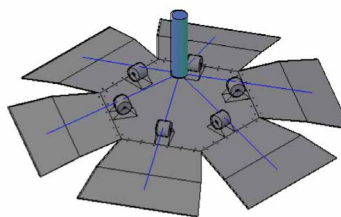
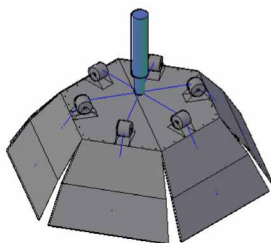

Personal Information:

First name: _____

Nationality: _____

Age: _____ years old

You are a:

girl

boy

How are you feeling today?

Good

Not so good

Bad

Do you have hearing impairment?

Yes

No



I don't know

Questions about the device:

1. Is it necessary to reduce noise in your classroom?

- Yes, it's very necessary Yes, it's necessary
 No, it's not necessary I don't know



2. Is this device able to create a quiet learning environment?

- Yes, it works very well 
 Yes, it works 
 No, it doesn't work 
 I don't know



3. Will reducing noise help you with your school performance?

- Help a lot Help a little
 Not help I don't know

4. What is the impact of this device on your school performance?

- Good impact 
 No impact 
 Bad impact 
 I don't know

5. Do you think the device is easy to use?

- Yes 
 I don't know 
 No 

6. Do you like the device?

- Yes No Why? _____

7. Would you like to have one in your class?

- Yes No Why? _____

8. If you have one in your classroom, how often will you change its mode (open/close)?

- several times a day once or twice per day
 less than once a day almost never

9. How would you improve this device or make it different if you were allowed to do that?

Thank you! And don't forget to ask your parent/supervisor to sign it!!

Appendix 7.B

The simulation results (with thicker acoustic foams).

G (dB)	125	250	500	1k	2k	4k	average (250-2k)
Control	32.2	33.3	36.0	36.1	35.1	39.0	35.1
A open; B open	31.6	32.3	33.4	33.2	32.7	34.5	32.9
A open; B closed	31.5	32.2	33.4	33.3	32.8	34.5	32.9
A closed; B closed	31.4	31.9	33.4	33.3	32.7	34.5	32.8
A closed; B open	31.5	32.0	33.4	33.1	32.7	34.5	32.8

Note: the absorption coefficients of the thicker acoustic foams at 125 250 500 1k 2k 4k frequencies were 0.20 0.60 0.82 0.99 1.00 1.00 respectively.

8 Conclusion

8.1 Introduction

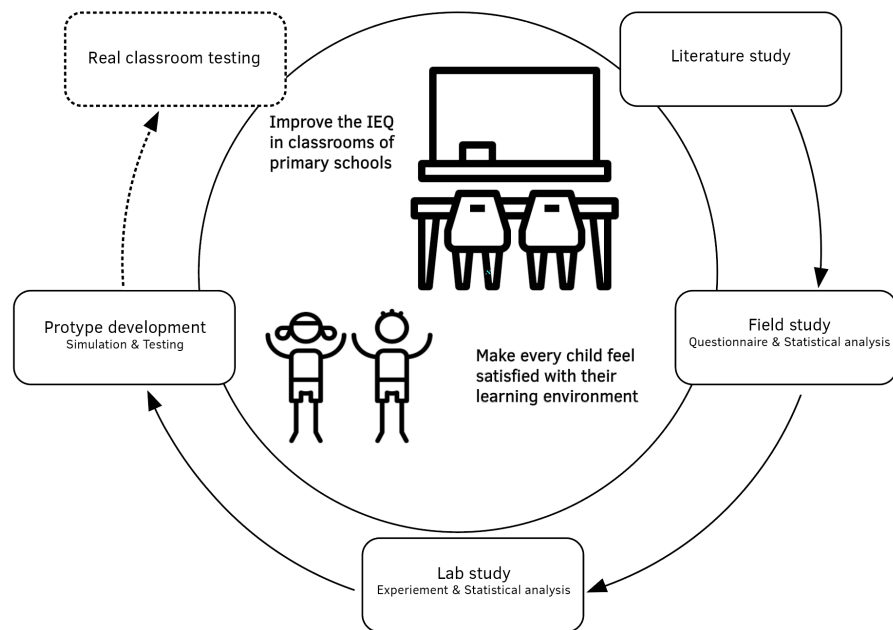

FIG. 8.1 The main stages and the main aims of this PhD study.

Note: the 'Real classroom testing' is a plan for the future. So, it is in a dashed line box.

This PhD study aimed to explore the possibility of introducing individually controlled devices into primary school classrooms to improve the IEQ and make every child feel satisfied with their learning environment. To achieve this aim, as shown in Figure 8.1, four sub-studies were conducted: literature study, field study, lab study

and prototype study. Several data collection techniques (such as questionnaires, physical measurements, and simulations) and several data analysis methods (such as descriptive analysis, independent t-test, Chi-squared test, and two-step cluster analysis) were used. A mixed methods design was applied in the prototype testing: both quantitative and qualitative data were collected.

This chapter presents the general conclusions drawn from this PhD study. First, in section 8.2 the answers to the sub-questions are given, which lead to a comprehensive answer to the main question of this research. Then, section 8.3 describes the limitations of this research. Next, in section 8.4 the practical implications of the overall results are discussed. Finally, section 8.5 concludes this chapter with suggestions for further research.

8.2 Answers to the research questions

8.2.1 sub-questions

1 What are the IEQ-related problems and solutions in classrooms of primary schools? (ch. 2)

This question aimed to identify and summarise the current IEQ problems and solutions in primary school classrooms. To answer this question, a number of scientific articles about IEQ in classrooms, particularly in relation to comfort and performance were reviewed. In addition, current solutions were searched for; individual control was one of them. Most of these peer-reviewed papers were published in the last 20 years, and they were found through keywords searches in electronic databases, such as TU Delft library, Web of Science, Engineering Village and the American Society of Heating, Refrigerating and Air-conditioning Engineers (ASHRAE). All the detailed information about these studies are described in chapter 2.

The most important finding of this chapter is that the indoor environment in a large number of classrooms is unhealthy and uncomfortable for children, which can impair their learning ability [1, 2]. Although many studies have been conducted to

investigate and solve these IEQ-related problems, most of them were focused on a single factor of IEQ (e.g. acoustical quality, IAQ, lighting quality, or thermal comfort). As a result, the cross-effects between these factors and the integrated effects of all these factors are still not well understood [3]. Moreover, it was seen in previous studies that school children did not have the possibility to change the indoor environment even though they felt uncomfortable with it.

Apart from listing the IEQ problems and solutions, in this chapter a new and challenging method - individual control - to fix these problems was identified. Because people, no matter whether children or adults, are different from each other and they have different preferences towards IEQ, individual control seems a good solution. Several studies have proved the effectiveness of individually controlled devices in improving IEQ in offices with adults [4, 5]. The same or a similar effect may also be expected when applying individual control in classrooms.

2 What are the underlying reasons for these problems?

In order to answer this question, questionnaire data from 54 teachers and 1145 children from a field study conducted in 54 classrooms of 21 primary schools in the Netherlands were analysed. To get a comprehensive understanding, this sub-question was investigated from two different perspectives, namely the children's perspective and the teachers' perspective. Each of them is corresponding to one chapter of this thesis, and the following two sections present the main findings of these two chapters, which are also the answers to sub-questions 2a and 2b.

2 A How do available ways to control the indoor environment work? (ch. 3)

In almost all classrooms of primary schools, the teacher is the only one who has the ability to control the IEQ. Therefore, it is interesting to identify what teachers usually do to change the IEQ in classrooms and what the effect of these actions on children's IEQ perceptions is. To find out, 54 teachers from different classrooms of 21 Dutch primary schools were asked to complete the teachers' questionnaire about the frequencies of their IEQ-improving actions (see Figure 8.2) and the children's requests to conduct these actions. Besides, the answers of 1145 children from the same classrooms to a series of questions about their IEQ perceptions in classrooms were included in the analysis.

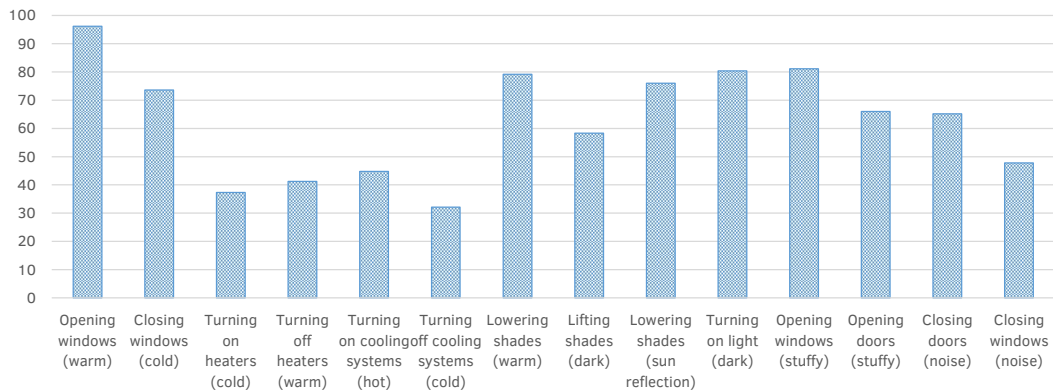

FIG. 8.2 Percentage of teachers who performed these actions at least once a day in the classrooms.

Three correlation analyses were conducted among teacher’s actions to improve IEQ, children’s requests related to IEQ and children’s perception of IEQ. The results did indicate a statistically significant relationship between teachers’ actions and children’s requests. For example, the most common action conducted by teachers was opening windows because of being “too warm”, and the most frequent request of the children was also opening windows because of thermal discomfort. However, neither a relationship was found between teachers’ actions and children’s perception of IEQ nor between children’s requests and their perceptions of IEQ, except for noise. This means that since children’s requests did not relate to their perceptions, even though teachers did take actions based on children’s requests, they could not improve children’s perceptions of IEQ.

A possible reason for the non-existing relationship between children’s requests (received by teachers) and their perceptions of IEQ could be that different children had different perceptions of IEQ, and thereby had different requests, but the teacher could only act upon one request at a time. Additionally, the reason why there is no relationship between teachers’ actions and children’s perception might be that the actions teachers could take to control the IEQ in classrooms were very limited. Therefore, a more effective method to improve IEQ that can be controlled by every individual child seems needed.

2 B What are the preferences and needs for IEQ of different school children? (ch. 4)

The most common way to investigate the IEQ in a classroom is to analyse the data collected from the children in this classroom as a whole and to only consider the average values. Moreover, most studies only focused on children's IEQ perceptions; little attention has been paid to their IEQ preferences and needs. To fill these knowledge gaps, this part of the study aimed to identify school children's IEQ perceptions, preferences, and needs at individual level.

To do that, in the questionnaire for the 1145 school children of the field study, apart from the questions about their perceived IEQ, special questions were included to identify children's preferences and needs: they were asked to choose their favourite individually controlled devices among six provided devices (including personal ventilation, desk lamp, heated chair, heated desk, and heated back) that were shown in a cartoon figure (see Figure 8.3), and to rank 10 common indoor environmental factors (including feet temperature, air temperature, chair temperature, scents, fresh air, light on desk, light on board, hearing teacher, outside sounds, inside sounds) in order of importance. Then, the children's IEQ perceptions, preferences and needs were analysed by descriptive analysis, correlation analysis and two-step cluster analysis.



FIG. 8.3 The cartoon figure added in the children's questionnaire (with permission from Robert Laszlo Kiss).

The results showed that different children had different IEQ perceptions, preferences and needs, based on which six clusters were identified: 'Sound concerned', 'Smell and Sound concerned', 'Thermal and Draught concerned', 'Light concerned', 'All concerned' and 'Nothing concerned' (see Table 8.1). Considering their different IEQ perception, preferences, and needs, the traditional way to improve the IEQ on the room level cannot satisfy every child in the classroom, and that is why there are always complaints about the IEQ in classrooms. In this context, providing a customised solution for each child in a classroom would be a more effective way to fulfil school children's IEQ needs in the future.

3 What is the effect of the main IEQ problem - noise - on children's sound perception and school performance? (ch. 5)

According to the field study, noise was identified as the biggest IEQ problem in classrooms of Dutch primary schools; 87% of children reported that they were bothered by noise [6]. Then, the following question arised: what is the effect of noise on school children? To figure out the answer, chapter 5 presented an acoustic experiment conducted in the SenseLab.

During the experiment, the test chamber was divided into two chambers of each 6.0 m³ by a thick curtain: in the untreated chamber A, there was no acoustic treatment and the reverberation time was 0.30 s; in the acoustically treated chamber B all the walls and ceilings were covered by sound absorption panels and the reverberation time was 0.07 s. The experiment was conducted in these two chambers at the same time. In total, 335 school children (9 to 13 years old) participated in the experiment, during which they were asked to perform a series of listening tests (odd-one-out tests) under one of seven randomly played background sounds: 45 dB(A) or 60 dB(A) traffic noise, 45 dB(A) or 60 dB(A) children talking, 45 dB(A) or 60 dB(A) music, or no sound. Besides, their sound perceptions and expectations concerning the impact of these sounds on their school performance were collected.

By analysing the children's answers, this study found a statistically significant interactive impact of sound type and sound pressure level on children's performance and their self-assessment of the expected impact of these sounds on school performance, but only for the untreated chamber. Moreover, the second part of this study demonstrated the effect of acoustic treatment on children's sound perception and performance by comparing the results from these two chambers. The results showed that children reported the acoustically treated chamber to be significantly quieter than the untreated chamber, but they performed worse in the treated chamber than in the untreated chamber under common background sound in classrooms (namely 60 dB(A) children babble). This implies that a too short

reverberation time may cause overdamping. A minimum reverberation time should therefore also be stipulated in standards.

TABLE 8.1 Summary of the six profiles of children identified by this study.

Clusters	C1: Sound concerned (22.1%)	C2: All concerned (20.1%)	C3: Nothing concerned (19.3%)	C4: Smell and sound concerned (19.1%)	C5: Thermal and draught concerned (11.6%)	C6: Light concerned (7.8%)
Characteristics	100% of them were bothered by noise; they rated highest importance indexes for "indoor sound" and "outdoor sound"	Relatively high percentages of children were bothered by thermal discomfort, smell, noise and sunlight; all the IEQ factors were important for them	Relatively low percentages of children were bothered by the assessed IEQ sources; they rated low importance indexes for all the factors	100% of them were bothered by smell and noise; they rated highest importance indexes for "air temperature", "fresh air" and "hearing the teacher"	100% of them were bothered by draught and 62% (highest) of them were bothered by thermal discomfort	100% of them were bothered by artificial light and 94% of them were bothered by sunlight; they rated highest importance indexes for "light on table", "light on board"
Preferences of ICDs	62% of them wanted to have headphones	They were interested in all the six offered ICDs.	They showed least interests in all ICDs	68% of them preferred the ventilator	Highest percentage of them preferred heated chair and heated desk	They showed high interests in almost all ICDs, except for desk lamp.

4 How can we solve the main IEQ problem by means of individual control in classrooms of primary schools? (ch. 6)

To solve the acoustical problem in classrooms, two individually controlled devices ('single-sided canopies' and 'double-sided canopies') were proposed and tested by computer simulations in this part of the PhD study. These devices look like small cubical canopies that hang above each desk. They have two working modes: open and closed, which were used respectively in two common scenarios in classrooms: instruction with frontal teaching and self-study with children discussing among each other.

To test their effect on acoustic improvement of a classroom, a series of computer simulations were run in CATT-Acoustic™. The model was first calibrated with measurements in the Experience Room of the SenseLab. Then, these results were compared with the simulated results obtained from two traditional acoustic improvements ('half ceiling tiles' and 'full ceiling tiles') and a control setting where

no acoustic improvement was implemented. Therefore, in total, the acoustical conditions of five different classroom settings were simulated under two scenarios (instruction and self-study).

The results of the simulations indicated that both the individually controlled devices and the ceiling tiles could provide a better acoustic learning environment (namely, shorter reverberation time and higher speech transmission index) than the control setting, and the individually controlled devices worked better than the ceiling tiles even though the amounts of sound absorption materials were the same in these settings. In addition, the 'double-sided canopies' were better than the 'single-sided canopies', and the 'full-ceiling' was better than the 'half-ceiling', but the difference was not big. These results proved the feasibility and effectiveness of these individually controlled devices to improve acoustic quality in classrooms.

5 How well does an individually controlled acoustic device work from an acoustic and a user perspective? (ch. 7)

The simulation results from the previous chapter demonstrated the potential of the individually controlled devices to improve the acoustics. In chapter 7, one device was prototyped. Identical to the simulated devices, this prototype also had two modes (open and closed) that could be controlled using a remote controller. As shown in Figure 8.4, this prototype has six side fins, and all of them were covered with acoustic foams made from polyethylene.

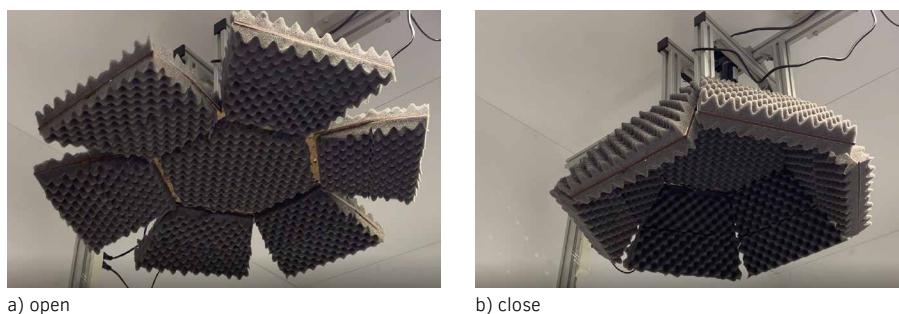

FIG. 8.4 The prototype of the individually controlled noise-reducing device.

In order to test their real function from a user's perspective, two identical devices were installed in the test chamber of the SenseLab, and a child-centred experiment was conducted with more than 200 school children. During the experiment, the participating children were invited to try these devices and then complete a short

questionnaire about their user experiences. Besides, a set of measurements and simulations were conducted to further test the effect of these devices on the acoustics.

Both the measurement and simulation results demonstrated the noise reduction effect of these devices. Moreover, descriptive analysis of the children's feedback showed a positive response to this device: 83% of the children liked this device; 83% thought it was easy to use; 64% thought it would have a good impact on their school performance; and 61% wanted to have this device in their classrooms. Furthermore, the content analysis of the children's answers identified the reasons for their preferences: they liked this device mainly because of its appearance, while they wanted to have it mainly because of its functionality. However, since this was just a prototype, there still is room for improvement and many children offered their suggestions, such as reducing the noise made by the motor, making it more colourful, and so on. If all these improvements could be achieved, then the device would work more effectively and it would be welcomed by more children.

8.2.2 main question

How to solve the main indoor environmental problem in classrooms of primary schools?

The answer was found through four research stages: literature study, field study, lab study and prototype study.

In the first study, a large number of peer-reviewed articles about IEQ and individual control were studied. The knowledge gap in previous research was identified, background information was provided, and a new research direction was proposed: the application of individual control in classrooms to improve both the IEQ and school children's satisfaction.

In the second study, data obtained from questionnaires completed by 1145 children and 54 teachers of 21 Dutch primary schools was analysed. The results indicated that there are many IEQ-related problems in classrooms, with noise being the main one. It was also found that the current solutions, namely the actions teachers take to control IEQ, were not useful for improving children's IEQ perceptions because a) different children have different IEQ perceptions and requests; and b) even though the teachers received the requests, they could not take effective actions to help the children because of the limited options they had. Therefore, a more effective IEQ control method is needed, preferably controlled by every individual child.

Before developing this more effective method, a deeper understanding of the main problem – noise – was needed. Therefore, the third study comprised of a lab study on the impact of noise in the SenseLab. 335 school children's sound perceptions, listening performances, and self-assessments of the expected influence of the sounds on their school performance were collected and analysed. The results demonstrated the effect of acoustic treatment and the significant interactive impact of sound type and sound pressure level on children's sound perception and performance.

After identifying the main indoor environmental problem and understanding its impact in classrooms, the last study focused on solving this problem by developing an individually controlled device. With this device, every child could control their local acoustic environment by themselves. At first, the design and test processes were completed by means of simulations. After confirming its effectiveness, a prototype was made and tested with children. Children's feedback further confirmed its feasibility: most of the children liked this device, thought it could reduce noise, and wanted to have it in their classrooms.

In conclusion, in this PhD research it was found that school children may have different IEQ perceptions, preferences and needs, and that they should be treated as individuals. Therefore, it is suggested to use individual control to improve the IEQ in classrooms of primary schools. Furthermore, to solve the main IEQ problem in classrooms – noise –, an individually controlled device for noise reduction was developed. This device can be hung above each school child's head and can be controlled by every school child individually. The effectiveness of this device was proven by simulations. Moreover, a user-centred test showed that this device was beloved and wanted by the participating children.

8.3 Limitations of the research

This PhD research included several rigorous and continuous studies, the results of which could answer the research questions, and further meet the aims of this research to a substantial extent. Nevertheless, there are still some limitations of this research. To promote the individually controlled device more widely and to make the research replicable, the following three limitations of this research need to be addressed.

First, the subjects of this research were primary school children. However, both the field survey and the first lab experiment only involved children aged from 9 to 12 years old. Therefore, the results might not be applicable to all primary school children. Future research needs to extend the study sample by involving more and younger children. The extended sample also could be used to further develop and perfect the children's IEQ-profiles.

The second limitation concerns the data collection methods. Due to the language barrier, verbal communication methods, such as interviews, were not applied. Questionnaires were the main method used to collect children's feedback about the IEQ in their classrooms and about the tested devices. Most of the questions were answered by choosing options. These answers were easy to be analysed, but, the provided options might have affected or limited children's thoughts. Therefore, a more open data collection method, such as an interview or a focus group, could be used in the future.

Finally, the individually controlled device developed was not mature enough to enter into the market and to be used in real classrooms. There is still room for improvement based on the children's feedback. Moreover, this device only focused on acoustics; the other IEQ-problems still need to be dealt with and an integrated individually controlled device is still missing. The potential of the ICND in improving the local acoustics was demonstrated. So, the positive effect of the integrated individually controlled device is also expected to improve the overall IEQ in classrooms.

8.4 Practical implications

The main outcomes of this PhD research are a) six children's profiles that describe different children's IEQ perceptions, preferences and needs, and b) an ICND that was demonstrated to be helpful in improving the acoustical quality and children's sound perception and performance. The specific implications of these outcomes are presented below:

Develop more specific classroom IEQ guidelines taking account of individual control.

The six children's profiles described in chapter 4 implied that different children have different IEQ needs in their classrooms. So, one-size-fits-all requirements for IEQ cannot guarantee a comfortable learning environment for all children in the same classroom. However, developing different guidelines for different children also seems unpractical. Given that the individual control was proposed as an effective way to improve both the IEQ and children's satisfaction rate in classrooms, it would make more sense to add some individual control related items in the guidelines. For example, the adjustment range of each IEQ factor that children could change by themselves would be an important value that should be clarified.

Apply individually controlled devices in real classrooms

The ICND developed was tested to be useful through computer simulations and laboratory tests. However, how well it works in real classrooms is still not understood. There are much more different noise sources in real classrooms, it might be difficult to predict its real function based on the results obtained. Therefore, a field test of this device should be conducted before introducing this device into real classrooms. Nevertheless, as mentioned in chapter 7, in real classrooms the reverberant field will be dominant. So, the devices should work more effectively than in the small test chamber since more sound waves would pass the devices before they arrive at the receivers in the classrooms. Therefore, a more obvious effect of the ICNDs is expected to be found in real classrooms.

Apart from the ICND, more individually controlled devices targeting the other IEQ-factors are also needed in classrooms to improve the overall IEQ-perceptions. Several studies have designed and developed such devices (e.g. personal ventilation, heated chair, desk lamp etc.) for adults in offices and proved their effectiveness in improving occupants' satisfaction and performance [7-9]. Both the results of applying individually controlled devices in offices and the results of the present PhD research imply that there is a potential for introducing individually controlled devices in classrooms.

8.5 Future research

This PhD research presented several new outcomes, such as the children's profiles and the ICND, that could be further developed in the future. Some related suggestions are listed below:

Improvement of the ICND based on the children's feedback

As mentioned in chapter 7, the ICND developed was just a prototype, there is still room for improvement. Some recommendations are presented below:

- Reduce the noise created by the device by means of replacing the motor to a quieter one or using manual control (i.e. by pulling ropes) instead of electric control.
- Improve its noise-reducing effect by increasing the thickness of the acoustic absorption layers.
- Make the height of it adjustable so that children can lower its height when they want to concentrate.
- Make it more beautiful and colourful by adding some decoration on it.

If all of these improvements are achieved, then the ICND will be more effective in creating a better environment in which the act of learning will be done in the best way with minimal discomfort and every child will feel more satisfied with their local acoustic environment.

Develop a multi-functional individually controlled device by combining the control over all IEQ factors

Besides the promotion of the ICND, there is a need for future research on developing a multi-functional individually controlled device or an integrated individually controlled system that could improve the overall IEQ-perception. Currently, fundamental research on and technical support for designing individually controlled devices targeting single IEQ-factors is well on track. However, an integrated system that covers all of them is still waiting to be developed. Moreover, the individually controlled devices that have been studied often and/or can be found on the market have all been designed for adults. The subject of designing individually controlled devices for school children is entirely unexplored. Furthermore, it would be interesting to identify the interactive impact of these control functions on school

children's IEQ-perception and performance. Summing up the above, developing a multi-functional individually controlled device for children should be a meaningful and valuable topic for future research.

To achieve this goal, the ICND presented in this PhD research could be viewed as the first step in this process, because noise was found to be the biggest problem in primary school classrooms and almost all the children were bothered by it. Then, the next step might be that combining it with other devices targeting other IEQ-factors, such as personal ventilation, a desk lamp, or a radiant heating panel. In this step, many mature devices designed for adults could be seen as references.

Test the device in real classrooms

Based on the results obtained from the simulations and laboratory tests, one could conclude that the ICNDs could improve the acoustical quality in classrooms and most children liked and wanted to have it in their classrooms (see chapters 6 and 7). However, the impact of these devices in real classrooms is still unknown. Given the fact that many individually controlled devices were demonstrated to be effective to increase the work performance [4, 10] and most children thought the ICND presented could reduce noise and would have good impact on their school performance, the positive effect of individually controlled devices on children's IEQ-perception and school performance in real classrooms needs to be tested in the future.

To do this, a pre- and post- intervention study might be a feasible and effective method to limit the impact of individual differences. Besides, future field studies should involve not only self-reporting questionnaires and performance tasks, but also physical measurements of all IEQ-factors. By doing so, future research could obtain a clear and comprehensible understanding of the effect of the individually controlled devices in classrooms of primary schools.

References

- [1] Johnson, P.D. and W.A. Kritsonis, Greener Schools, Greater Learning, and the LEED Value, *Online Submission*, 2010. 7(1).
- [2] Kats, G., Greening America's Schools, *American Federation of Teachers, et al. Capital E*, 2006.
- [3] Bluysen, P.M., 2019. Towards an integrated analysis of the indoor environmental factors and its effects on occupants, Intelligent Buildings International, DOI: 10.1080/17508975.2019.1599318.
- [4] Melikov, A.K., M. Skwarczynski, J. Kaczmarczyk, and J. Zabecky, Use of personalized ventilation for improving health, comfort, and performance at high room temperature and humidity, *Indoor Air*, 2013. 23(3): p. 250-263.
- [5] Zhang, H., Arens, E., Kim, D., Buchberger, E., Bauman, F. and Huizenga, C., 2010. Comfort, perceived air quality, and work performance in a low-power task–ambient conditioning system, *Building and Environment*, 45(1), pp.29-39..
- [6] Bluysen, P.M., D. Zhang, S. Kurvers, M. Overtoom, and M. Ortiz-Sanchez, Self-reported health and comfort of school children in 54 classrooms of 21 Dutch school buildings, *Building and Environment*, 2018. 138: p. 106-123.
- [7] Melikov, A.K., H. Groengeak, and J.B. Nielsen, Personal Ventilation: from research to practical use, *Proceedings of CLIMA, Helsinki, 2007*.
- [8] Pasut, W., H. Zhang, E. Arens, S. Kaam, and Y. Zhai, Effect of a heated and cooled office chair on thermal comfort, *HVAC&R Research*, 2013. 19(5): p. 574-583.
- [9] Tabuchi, Y., K. Matsushima, and H. Nakamura, Preferred illuminances on surrounding surfaces in relation to task illuminance in office room using task–ambient lighting, *Journal of Light & Visual Environment*, 1995. 19(1): p. 28-39.
- [10] Wyon, D.P., Individual control at each workplace: the means and the potential benefits, *Creating the productive workplace*, 2000: p. 192-206.

Curriculum Vitae



- 07.1991** Born in Beijing, China
- 09.2009 – 06.2013** Bachelor of Engineering,
University of Science and Technology Beijing, China
- 01.2013 – 07.2013** Assistant Engineer,
China Academy of Building Research, Beijing, China
- 09.2013 – 01.2016** Master of Engineering,
University of Science and Technology Beijing, China
- 09.2016 – 07.2020** PhD candidate, Chair of Indoor Environment,
Faculty of Architecture and the Built Environment, TU Delft,
the Netherlands
- 02.2020 – 04.2020** Teaching assistant, Technoledge Climate design,
Faculty of Architecture and Built Environment, TU Delft,
the Netherlands

List of publications

Journal papers

Zhang, Dadi, Martin Tenpierik, and Philomena M. Bluysen. “Individual control as a new way to improve classroom acoustics: a simulation-based study.” *Applied acoustics*. Under review.

Zhang, Dadi, Martin Tenpierik, and Philomena M. Bluysen. “A child-centred experiment to test a new individually controlled acoustic improvement device.” *Indoor and Built Environment*. Under review.

Zhang, Dadi, Marco A. Ortiz, and Philomena M. Bluysen. “Clustering of Dutch school children based on their preferences and needs of the IEQ in classrooms.” *Building and Environment* 147 (2019): 258-266.

Zhang, Dadi, and Philomena M. Bluysen. “Actions of primary school teachers to improve the indoor environmental quality of classrooms in the Netherlands.” *Intelligent Buildings International* (2019): DOI: 10.1080/17508975.2019.1617100.

Zhang, Dadi, Martin Tenpierik, and Philomena M. Bluysen. “Interaction effect of background sound type and sound pressure level on children of primary schools in the Netherlands.” *Applied Acoustics* 154 (2019): 161-169.

Bluysen, Philomena M., **Dadi Zhang**, Stanley Kurvers, Marjolein Overtoom, and Marco Ortiz-Sanchez. “Self-reported health and comfort of school children in 54 classrooms of 21 Dutch school buildings.” *Building and environment* 138 (2018): 106-123.

Bluysen, Philomena M., **Dadi Zhang**, Dong Hyun Kim, AnneMarie Eijkelenboom, and Marco Ortiz-Sanchez. “First SenseLab studies with primary school children: exposure to different environmental configurations in the experience room.” *Intelligent Buildings International* (2019): DOI:10.1080/17508975.2019.1661220.

Conference papers

Zhang, Dadi, Martin Tenpierik, and Philomena M. Bluysen. "The effect of acoustical treatment on primary school children's performance, sound perception, and influence assessment." In *E3S Web of Conferences*, vol. 111. EDP Sciences, 2019, 02046, CLIMA 2019, May 25-29 2019, Bucharest, Romania.

Ortiz, Marco A., **Dadi Zhang**, and Philomena M. Bluysen. "Table top surface appraisal by school children under different lighting conditions tested in the Senselab." In *E3S Web of Conferences*, vol. 111. 2019, 02040, CLIMA 2019, May 25-29 2019, Bucharest, Romania.

Bluysen, Philomena M., **Dadi Zhang**, Arend-Jan Krooneman, and Arno Freeke. "The effect of wall and floor colouring on temperature and draught feeling of primary school children." In *E3S Web of Conferences*, vol. 111. EDP Sciences, 2019, 02032, CLIMA2019, May 25-29 2019, Bucharest, Romania..

Armijos Moya, Tatiana, **Dadi Zhang**, and Philomena M. Bluysen. "Perceived Air Quality of different sources of smell evaluated by primary school children." In *E3S Web of Conferences*, vol. 111. EDP Sciences, 2019, 06043, CLIMA 2019, May 25-29 2019, Bucharest, Romania..

Zhang, Dadi, Martin Tenpierik, and Philomena M. Bluysen. "Designing an Individually Controlled System based on children's' perception and preferences of IEQ in a classroom. 2018". Presented at *the Indoor Air 2018: 15th Conference of the International Society for Indoor Air Quality and Climate (ISIAQ)*, Philadelphia, United States, paper 399.

Zhang, Dadi, Stanley Kurvers, David Keyson, Philomena M. Bluysen, "Local control of IEQ in classrooms: what do we know? ," presented at *the Healthy Buildings 2017 Europe*, Lublin, Poland, 2017, paper ID 0033.

Individually controlled noise reducing devices to improve IEQ in classrooms of primary schools

Dadi Zhang

It is well-known that the indoor environmental quality (IEQ) at schools affects the health, comfort and performance of school children. Considering the need for a more effective way to improve both the IEQ in primary school classrooms and children's satisfaction, along with the positive potential of individual control, this thesis aimed to propose a new way - individual control - to improve the IEQ in classrooms of primary schools and to increase children's satisfaction in the Netherlands.

First the main IEQ problem in classrooms as well as IEQ perceptions and preferences of the school children were identified through literature and field studies. The outcome showed that noise was the main IEQ problem in classrooms of Dutch primary schools, children could be clustered in according to their IEQ perceptions and preferences, and the reported IEQ-improving actions of the teachers could not effectively improve the IEQ for each child.

As a follow-up, lab studies were performed in the SenseLab to explore the effect of background sound on children's sound perception and performance. Together with the outcome of the field studies, results suggested that individual control is a better way to improve IEQ in classrooms.

Therefore, to address the main problem - noise - in classrooms, an individually controlled noise-reducing device was designed, prototyped and tested with school children in the SenseLab. The results obtained from the simulations, measurements, and children's feedback on the prototype of the device, demonstrated the feasibility of such devices in classrooms at primary schools.