

Corporate Real Estate alignment

a preference-based design
and decision approach

Monique Arkesteijn



Corporate Real Estate alignment

a preference-based design
and decision approach

Monique Arkesteijn



A+BE | Architecture and the Built Environment | TU Delft BK

19#12

Design | Sirene Ontwerpers, Rotterdam

Cover art | Janet Vollebregt

Keywords | Corporate real estate alignment, design and decision approach, adding value, preference measurement

ISBN 978-94-6366-226-0

ISSN 2212-3202

© 2019 Monique Arkesteijn

Digital version freely available at abe.tudelft.nl

All rights reserved. No part of the material protected by this copyright notice may be reproduced or utilized in any form or by any means, electronic or mechanical, including photocopying, recording or by any information storage and retrieval system, without written permission from the author.

Unless otherwise specified, all the photographs in this thesis were taken by the author. For the use of illustrations effort has been made to ask permission for the legal owners as far as possible. We apologize for those cases in which we did not succeed. These legal owners are kindly requested to contact the publisher.

Corporate Real Estate alignment

a preference-based design
and decision approach

Dissertation

for the purpose of obtaining the degree of doctor
at Delft University of Technology
by the authority of the Rector Magnificus, prof.dr.ir. T.H.J.J. van der Hagen
chair of the Board for Doctorates
to be defended publicly on
Wednesday, 4 December 2019 at 10:00 o'clock

by

Monique Hendrina ARKESTEIJN
Master of Science Architecture, Urbanism and Building Sciences,
Delft University of Technology, The Netherlands
born in Delft, The Netherlands

This dissertation has been approved by the promotor.

Composition of the doctoral committee:

Rector Magnificus	chairperson
Prof.ir. H. de Jonge	Delft University of Technology, promotor
Prof.dr. J. Barzilai	Dalhousie University, promotor

Independent members:

Prof.dr.ir. A. Verbraeck	Delft University of Technology
Prof.dr. G.P.M.R. Dewulf	University of Twente
Prof.dr.ir. P.J.V. van Wesemael	Eindhoven University of Technology
Prof.dr.ir. M.H. Hermans	Delft University of Technology
Prof.ir. M.F. Asselbergs	Delft University of Technology
Prof.dr. P.W. Chan	Delft University of Technology, reserve member

This research was partially funded by the Facility Management and Real Estate department of the TU Delft.

Preface

In 2003, I started my academic career at Delft University of Technology (TU Delft) after an intensive period of travelling abroad. After finishing an executive MBA with a focus on personal leadership and innovation I wondered about the meaning of life. I could not believe that life was only about working and earning (more) money, so I decided to withdraw myself from this “career highway” and do something I loved: travelling. I experienced that you are able to slow down time, although life seems to go faster when you get older, I encountered beautiful people and experienced a different side of life: meditation, walking, being in nature and being peaceful. And most importantly, it brought me my love Eric and our beautiful daughter Danielle.

When I came back to TU Delft, I had a new perspective on real estate: I wanted to specialize myself in ‘love and the built environment’. My assumption was that “whatever we make or do becomes better when we approach it with love, as if we build for our children or our parents”. Because, you would want the best for them. I also realized that ‘the best’ depends on what a person wants; it could be something beautiful, functional, affordable or any combination in between and at the same time understanding the consequences of their demands. However, since ‘love’ is difficult to operationalize I started to focus on ‘value’, as value -or adding value- was one of the main research themes in our real estate management section. Over the years, our section explored these concepts from many perspectives.

This was why the famous sentence ‘Everything of value is defenseless’ from Lucebert was repeatedly quoted by our professor Hans de Jonge. Often I implicitly and immediately agreed with the meaning of this sentence. It appeals in general, because it felt true. Not only in life, but also in the domain of corporate real estate, where everything of value often can be overwhelmed by, for instance, finances. This brought me to look at the concept of value more closely. In examining Luceberts’ poem ‘*De zeer oude zingt*’ (1974), Lucebert expert Hofman wrote in his Trouw article that the poem is “... rather philosophical and needs to be quietly taken into you” (Hofman, 2006). He indicates that the core of the poem is that “Only when it is about that what is, here and now, it becomes serious. The quality of being is determined in the absolute now: how conscious you are present in the here and now” Hofman (2006). This is important for my research, because as Hofman states: “... ‘the heart of time’ is the present, in which everything of value can be touched, and is closer than we think”.

In my PhD research, I am presently convinced that everything of value can be made more defensible. It is defensible, because we can be as conscious in the present as possible. And we can do more: we can make that what we value explicit and measurable. Value to me is not objective, 'Value is in the eye of the beholder'. So, the (added) value will differ from one person to another. I was challenged by the question 'how do you *actually* know if CRE adds value to an organization in the strategy formation process, i.e. the decision making process, and especially whether the organization is optimally attuned? In answering this question I chose a different route, when I connected to associate professor Peter Paul van Loon with his scientific and philosophical approach to inter-organizational design, and to doctor Ruud Binnekamp with his preference-based design procedure and to professor Jonathan Barzilai with his fundamental knowledge on decision making and the measurement of preference. This brought me to examine value closer, and to define value as technically equivalent to preference, quality, and utility in this PhD research. By doing so, everything of value can be made more defensible.

I have always been surprised that although many people agree with the statement 'Value is in the eye of the beholder' and therefore value is 'subjective'. Nonetheless, there still is a need to 'objectify' at the same time, as if the 'objective' is better than the 'subjective'. In this thesis PAS is labelled as an (inter)subjective rational approach, because the input in the model is subjective, connected to a subject, a (group of) person(s). The person determines the norm, i.e. what he or she values. It is up to the person whether this norm or preference has been created intuitively or whether it has been rationally substantiated. On the other hand, the outcome of the model can be described as rational. No interpretation is needed, because given the subjective input, the logical result is always the same.

In this thesis, I made (all types of) value defensible by making them measurable, not only in financial terms, but by translating everything into preference. However, this does not mean that I claim that this is the best approach to CRE alignment. I offer an approach that would enable CRE managers to measure the added value of their CRE portfolios. I am not stating that this new PAS approach is better than others or that all organizations should use this approach. I do say that if organizations want an approach that enables them in an operational way to measure the added value of new CRE portfolios taking into account all types of value, PAS offers a way to do that.

As such, I limited myself to enhancing a part of the prescriptive schools towards strategy design in the field of CRE alignment. The prescriptive schools are distinguished by Mintzberg, Ahlstrand and Lampel (1998) in '*Strategy Safari*' and focus on how strategies *should be created*. The descriptive schools on the other hand focus on how a strategy *is created in practice*. The third group combines the

others and is called by Mintzberg et al. the configuration school. They developed a typology of ten different schools of thought based on these three attitudes to the way strategies are generated. The three prescriptive schools are the planning, positioning and design school. Later on, in '*Strategy bites back*' Mintzberg, Ahlstrand and Lampel (2005) present seven views on strategy formation based on the way strategies approach synthesis. They formulate their view on strategy formation as follows "Only when you, as a reader, put them together - see them in juxtaposition and combine them in application – do they come usefully alive. As Gary Hamel put it, starkly, 'The dirty little secret of the strategy industry is that it doesn't have any theory of strategy creation'. Strategy has to come out of a creative process conducted by thoughtful people" (Mintzberg et al., 2005, p. 5). De Jonge et al. (2009) also use strategy pluralism approach in accommodation strategy design by using ideas, concepts and models from different strategy perspectives that could support the design of an accommodation strategy.

I hope that the result of this thesis will be used as part of the prescriptive schools and will be combined with the descriptive schools to form/make/design CRE strategies in order to create a complete strategy picture.

Contents (concise)

1 Introduction 43

2 Corporate Real Estate alignment 57

- 2.1 Corporate Real Estate alignment an overview of the state of the art 59
- 2.2 Assessment of CRE alignment models from a design and decision making point of view 72
- 2.3 Conclusion 86

3 Basic concepts and definitions of the PAS design and decision system 93

- 3.1 Basic concepts and definitions 94
- 3.2 Preference measurement 122
- 3.3 Preference-Based Design methodology 127
- 3.4 Foundations in different scientific fields 134
- 3.5 Conclusion and comparison 139

4 Preference-based Accommodation Strategy design and decision approach 145

- 4.1 Research methods to develop, test and evaluate PAS 146
- 4.2 Main concepts and components PAS 150
- 4.3 PAS steps 156
- 4.4 Stakeholders and activities in PAS 165
- 4.5 PAS generic mathematical models 173
- 4.6 Conclusion and coherence between three PAS components 178

5 PAS steps to achieve alignment 183

- 5.1 Pilot study 1: TU Delft's food facilities 185
- 5.2 Pilot study 2: TU Delft's lecture halls 207
- 5.3 Pilot study 3: Oracle's office locations 221
- 5.4 Pilot study comparison and conclusion 230

6	PAS stakeholders & activities to achieve alignment	235
6.1	Pilot study 1: TU Delft's food facilities	238
6.2	Pilot study 2: TU Delft's lecture halls	249
6.3	Pilot study 3: Oracle's office locations	267
6.4	Pilot study comparison and conclusion	273
7	PAS mathematical models to achieve alignment	279
7.1	Pilot study 1: TU Delft's food facilities	282
7.2	Pilot study 2: TU Delft's lecture halls	294
7.3	Pilot study 3: Oracle's office locations	296
7.4	Pilot study comparison and conclusion	300
8	PAS evaluation	303
8.1	Pilot study 1: TU Delft's food facilities	304
8.2	Pilot study 2: TU Delft's lecture halls	308
8.3	Pilot study 3: Oracle's office locations	316
8.4	Pilot study comparison and conclusion	322
9	Reflecting upon PAS	329
9.1	PAS as add-on to existing CRE alignment models	330
9.2	PAS as design methodology	332
9.3	PAS design decision management system	337
9.4	Conclusion	357
10	Conclusions and recommendations	361
10.1	Conclusions	361
10.2	Recommendations	368

Contents

List of Tables	17
List of Figures	19
Acronyms	25
Summary	27
Samenvatting	33

1 Introduction 43

2 Corporate Real Estate alignment 57

2.1	Corporate Real Estate alignment an overview of the state of the art	59
2.1.1	Understanding CRE alignment	60
2.1.2	Understanding the cognitive objects being aligned	61
2.1.3	Understanding the alignment directionality	63
2.1.4	Understanding the multi-valent relationship between the business and CRE	64
2.1.5	Understanding forms of alignment	65
2.1.6	CRE alignment's building blocks	66
2.1.7	Designing an Accommodation Strategy frame (DAS)	71
2.2	Assessment of CRE alignment models from a design and decision making point of view	72
2.2.1	First assessment of CRE alignment models	74
2.2.2	Second assessment of CRE alignment models	77
2.2.3	Third assessment of CRE alignment models	82
2.2.4	Summary of assessment criteria	85
2.3	Conclusion	86

3 Basic concepts and definitions of the PAS design and decision system 93

3.1	Basic concepts and definitions	94
3.1.1	Three types of decision making rationality in PAS	95
3.1.2	PAS as a goal-oriented human system	96
3.1.3	The concept of the overall performance measure in PAS	98
3.1.4	Definitions of problems, goals and value as applied in PAS	100
3.1.5	Multiple criteria as applied in PAS	103
3.1.6	Specification and modeling of design problems in PAS	104
3.1.7	PAS as a multi actor design-decision-management system	106
3.1.8	PAS as a prescriptive mathematical decision system	107
3.1.9	Preference measurement in PAS	109
3.1.10	The overall preference score as performance measure in PAS	111
3.1.11	PAS as a problem solving system	113
3.1.12	PAS as an operational representation of the design (solution) space	116
3.1.13	The Preference-Based Design method as applied in PAS	118
3.1.14	PAS as a design management system	119
3.1.15	PAS as Human Activity System	121
3.2	Preference measurement	122
3.2.1	Measurement of psychological properties	122
3.2.2	Mathematical foundations	124
3.2.3	Preference Function Modeling	127
3.3	Preference-Based Design methodology	127
3.3.1	Objective and foundations of the Preference-Based Design methodology	128
3.3.2	Design concept of the Preference-Based Design procedure	129
3.3.3	Preference-Based Design procedure	130
3.3.4	Preference-Based Design applications	132
3.3.5	Preference-Based Design methodology conclusions and recommendations	132
3.4	Foundations in different scientific fields	134
3.5	Conclusion and comparison	139

4 Preference-based Accommodation Strategy design and decision approach 145

- 4.1 **Research methods to develop, test and evaluate PAS** 146
 - 4.1.1 Main aim 146
 - 4.1.2 Research method to develop and test PAS 147
 - 4.1.3 Research method to determine the successfulness of PAS 148
 - 4.2 **Main concepts and components PAS** 150
 - 4.2.1 Two main concepts 150
 - 4.2.2 Three components of PAS 151
 - 4.2.3 Main development phases of PAS and its components 152
 - 4.3 **PAS steps** 156
 - 4.3.1 First version of PAS steps 156
 - 4.3.2 Final version of PAS steps 162
 - 4.4 **Stakeholders and activities in PAS** 165
 - 4.4.1 Relevant stakeholders for PAS 166
 - 4.4.2 PAS activities 169
 - 4.5 **PAS generic mathematical models** 173
 - 4.5.1 Principal formulas of the mathematical model 173
 - 4.5.2 Basic structure of the mathematical model 176
 - 4.5.3 Two techniques to generate the optimal alternative 176
 - 4.6 **Conclusion and coherence between three PAS components** 178
- ## 5 PAS steps to achieve alignment 183
-

- 5.1 **Pilot study 1: TU Delft's food facilities** 185
 - 5.1.1 Introducing the pilot study 185
 - 5.1.2 Stakeholders specified decision variables (step 1) 189
 - 5.1.3 Stakeholders determined preferences (step 2) 197
 - 5.1.4 Stakeholders assigned weights (step 3) 201
 - 5.1.5 Stakeholders determined design constraints (step 4) 202
 - 5.1.6 Stakeholders designed and chosen the best alternative (step 5a and 6) 203

5.2	Pilot study 2: TU Delft's lecture halls	207
5.2.1	Introducing the pilot study	207
5.2.2	Stakeholders specified decision variables (step 1)	212
5.2.3	Stakeholders determined preference curves (step 2)	212
5.2.4	Stakeholders assigned weights (step 3)	214
5.2.5	Stakeholders determined design constraints (step 4)	215
5.2.6	Stakeholders designed and chosen the best alternative (step 5a and 6)	216
5.3	Pilot study 3: Oracle's office locations	221
5.3.1	Introducing the Oracle pilot study office locations	222
5.3.2	Stakeholders chosen the best alternative (step 6)	226
5.4	Pilot study comparison and conclusion	230

6 PAS stakeholders & activities to achieve alignment 235

6.1	Pilot study 1: TU Delft's food facilities	238
6.1.1	Interfaces to design alternatives (step 5)	238
6.1.2	Workshops to design alternatives (step 5)	246
6.1.3	Iterating between alternatives (step 5) and requirements (steps 1 to 4)	247
6.2	Pilot study 2: TU Delft's lecture halls	249
6.2.1	Interfaces to design alternatives (step 5)	249
6.2.2	Workshops to design alternatives (step 5)	264
6.2.3	Iterating between alternatives (step 5) and requirements (steps 1 to 4)	266
6.3	Pilot study 3: Oracle's office locations	267
6.3.1	Interfaces to design alternatives (step 5)	267
6.3.2	Workshops to design alternatives (step 5)	270
6.3.3	Iterating between alternatives (step 5) and requirements (steps 1 to 4)	271
6.4	Pilot study comparison and conclusion	273

7 PAS mathematical models to achieve alignment 279

7.1	Pilot study 1: TU Delft's food facilities	282
7.1.1	Model's structure	282
7.1.2	Model's Formulas	282
7.1.3	Optimization tool	291

7.2	Pilot study 2: TU Delft's lecture halls	294
7.2.1	Model's structure	294
7.2.2	Model's Formulas	296
7.3	Pilot study 3: Oracle's office locations	296
7.3.1	Model's structure	297
7.3.2	Model's Formulas	299
7.3.3	Model's optimization tool	299
7.4	Pilot study comparison and conclusion	300

8 PAS evaluation 303

8.1	Pilot study 1: TU Delft's food facilities	304
8.1.1	The stakeholders' evaluation	304
8.1.2	The observers' evaluation	306
8.2	Pilot study 2: TU Delft's lecture halls	308
8.2.1	The stakeholders' evaluation	308
8.2.2	The observers' evaluation	314
8.3	Pilot study 3: Oracle's office locations	316
8.3.1	The stakeholders' evaluation	317
8.3.2	The observers' evaluation	321
8.4	Pilot study comparison and conclusion	322

9 Reflecting upon PAS 329

9.1	PAS as add-on to existing CRE alignment models	330
9.2	PAS as design methodology	332
9.3	PAS design decision management system	337
9.3.1	Basic features and structure of PAS design decision management model	338
9.3.2	PAS steering subsystem	343
9.3.3	PAS programming subsystem	345
9.3.4	PAS modeling subsystem	349
9.3.5	PAS design subsystem	353
9.4	Conclusion	357

10 Conclusions and recommendations 361

10.1 Conclusions 361

10.2 Recommendations 368

10.2.1 Improving PAS 368

10.2.2 Professionalizing PAS 370

References 373

Appendix A Designing an Accommodation Strategy (DAS) 378

Appendix B Link assessment criteria and labels 384

Appendix C Example of the Preference-Based Design procedure 385

Appendix D Preference ratings objects 389

Appendix E Additional design tools 390

Appendix F Matlab source for decision variable minimum walking time 397

Appendix G Descriptions of the functions 399

Appendix H Overview dates pilot studies 403

Acknowledgements 405

Curriculum vitae 409

List of Tables

- 2.1 Alignment directionality Note adapted from Heywood and Arkesteijn, 2017, p. 151 63
- 2.2 Alignment' words and their relationships' semantic quality. Note adapted from Heywood and Arkesteijn, 2017, p. 147 64
- 2.3 Criteria in the three assessments 74
- 2.4 Assessment of CREM and PREM models. 76
- 2.5 Second assessment of CRE alignment models 80
- 2.6 Summary of assessment criteria 85
- 3.1 Three types of rationality (based on Kickert, in De Leeuw, 2002) 95
- 3.2 Value matrix Note from De Vries et al., 2004 visualized by Van der Zwart, 2014, p. 219 102
- 3.3 Categories and characteristics of management science modeling techniques Note from Ragsdale 2008, p. 6. From Ragsdale. Managerial Decision Modeling, Revised, International Edition (with Student CD-ROM, Microsoft Project Management 2007 and Crystal Ball Pro Printed Access Card), 1E. © 2008 South-Western, a part of Cengage, Inc. Reproduced by permission. www.cengage.com/permissions 109
- 3.4 Summary of cases Binnekamp (2010) 132
- 4.1 Problem solving at three levels 148
- 4.2 Interview 1 149
- 4.3 Interview 2 and subsequent interviews 149
- 4.4 Decision variables and associated decision maker's preference ratings Note adapted from Arkesteijn & Binnekamp, 2013, p. 96 160
- 4.5 Decision variables and assigned decision maker's weights Note from Arkesteijn & Binnekamp, 2013, p. 97 161
- 4.6 Current portfolio and portfolio with highest overall preference score (Legend interventions 0=remove, 1=keep, 2=renovate) Note adapted from Arkesteijn & Binnekamp, 2013, p. 97 162
- 4.7 Stages used in developing PAS steps 165
- 4.8 Terminology of relevant groups 167
- 4.9 Questions in interview 1 170
- 4.10 Questions in interview 2 171
- 4.11 Assignments in workshop 2 172
- 5.1 Overview of food facilities and basic data (ordered on building number) 187
- 5.2 Scheduling result, for design alternative d_0 [current] and d_1 [future]. The input value can be changed by the decision makers to optimize the scheduling result (layout adapted) Note from Arkesteijn et al., 2015, p. 114 217
- 5.3 Categories of interest covered by criteria Note from De Visser, 2016, p. 62 226
- 5.4 Comparison of optimum portfolio alternatives to the current portfolio and the actual choice by LOB 1 Note adapted from De Visser, 2016, p. 83 legend: Locations in purple are part of 3 or more alternatives 227
- 5.5 Pilot comparison achieved added value alternative CRE portfolio design (step 5a) 230

5.6	Pilot comparison achieved added value alternative CRE portfolio design generated by optimization tool (step 5a&b)	231
5.7	Pilot study comparison on characteristics	231
6.1	Best alternatives as designed in the second workshop	247
6.2	Overview links PAS and DAS	264
6.3	Best alternatives as designed in the second workshop	265
7.1	Workspace pilot 1	287
7.2	Overall preference scores state vectors found by search algorithm	292
8.1	Checklist for evaluating DSSs and their development process Note adapted from De Visser, 2016, p. 89	316
9.1	Description conditions related to the four PAS systems	342
9.2	Description of PAS set up subsystem	344
9.3	Description of programming subsystem	346
9.4	Description of PAS modeling subsystem	350
9.5	Description of design subsystem	354
10.1	Achieved added value of the best design alternative (step 5a and 5b) in all pilots	365

List of Figures

- 1.1 Faculty of Architecture and the Built Environment building (corporate real estate) © Rob 't Hart Fotografie 42
- 1.2 Three components of PAS with each a different shade of purple Note adapted from Arkesteijn et al., 2017, p. 245 47
- 1.3 PAS development phases and focus 48
- 1.4 Readers guide (Note this guide is repeated at each chapter) 49
- 1.5 Simplified DAS Frame Note adapted from De Jonge, et al., 2009, p. 36, Van der Zwart et al., 2009, p. 3. and Den Heijer, 2011, p. xv. 52
- 1.6 Stakeholder perspectives Note from Den Heijer, 2011, p. xiv 53
- 2.1 Context and core of PhD research Note CP = conference paper JP = journal paper, R = reader, BC = book chapter and P = presentation. Dark purple publications (co-) author. 58
- 2.2 Timeline of CRE alignment authors (Arkesteijn & Heywood, 2013) 61
- 2.3 Business and CRE-related cognitive objects in the alignment models Note adapted from Heywood & Arkesteijn, 2017, p. 150 62
- 2.4 Forms of alignment Legend: number of authors and % of total authors that mention the alignment form. Note adapted from Heywood & Arkesteijn, 2017, p. 147 66
- 2.5 CRE alignment building blocks and components Note from Heywood & Arkesteijn, 2017, p. 17, NB. This categorization differs slightly from previous publication in Heywood (2011) as subsequent work has tested and refined the original work resulting in different components and names. 67
- 2.6 DAS frame (Den Heijer, 2011 adapted from De Jonge et al., 2009) 71
- 2.7 Focus of this research visualized in DAS Note adapted from De Jonge et al., 2009; Den Heijer, 2011; Van der Zwart et al., 2009 87
- 3.1 Problem origination Note adapted from De Leeuw, 2002, p. 36 101
- 3.2 Performance measurement as input-output system Note adapted from De Leeuw, 2002, p. 303 105
- 3.3 Diagnosis-design-change-model Note adapted from De Leeuw, 2002, p. 217 114
- 3.4 Prescriptive design process © Dym, C., & Little, P., (2004), Figure p. 24, Engineering Design: A Project-Based Introduction, Hoboken. In: NJ.: John Wiley & Sons Inc. Note Used with permission. All rights reserved. No part of this publication may be reproduced, stored in a retrieval system, or transmitted, in any form or any means, electronic, mechanical, photocopying, recording, scanning or otherwise, except as permitted Sections 107 or 108 of the 1976 United States Copyright Act, without prior permission of the original publisher. 115
- 3.5 Design space in LP with negotiable constraints Note from Van Loon et al., 2008, p. 11 117
- 3.6 SU/SS system Note adapted from De Leeuw, 2002, p. 155 120
- 3.7 A scale is a mapping of the objects in the empirical system into the objects in the mathematical system Note from Binnekamp, 2010, p. 25 123
- 3.8 Two example of an ordinal scale; since only order is determined both scales are the same regardless the exact position of digits 2,3 and 4. 124

3.9	Mathematical systems	125	4.8	Stakeholders & activities as component of PAS Note adapted from Arkesteijn et al., 2017, p. 245	166
3.10	Points on a straight line	126	4.9	CREM model Note from Den Heijer, 2011, p. 106	168
3.11	DAS simplified visualization Note simplified DAS adapted from De Jonge, et al., 2009, p. 36), Van der Zwart et al., 2009, p. 3. and Den Heijer, 2011, p. xv	134	4.10	Models as component of PAS Note adapted from Arkesteijn et al., 2017, p. 245	173
3.12	Dym and Little's steps compared to DAS Note simplified DAS adapted from De Jonge, et al., 2009, p. 36), Van der Zwart et al., 2009, p. 3. and Den Heijer, 2011, p. xv	137	4.11	Visualization generic mathematical PAS model Note based on de Visser 2016, p. 70	176
3.13	De Leeuw's DDC model compared to DAS Note simplified DAS adapted from De Jonge, et al., 2009, p. 36), Van der Zwart et al., 2009, p. 3. and Den Heijer, 2011, p. xv	137	4.12	Visualization global and local optimum	177
3.14	Barzilai's PFM and Tetra compared to DAS Note simplified DAS adapted from De Jonge, et al., 2009, p. 36), Van der Zwart et al., 2009, p. 3. and Den Heijer, 2011, p. xv	138	4.13	PAS Flowchart Note adapted from Arkesteijn et al., 2017, p. 248	179
3.15	Binnekamp's PBD compared to DAS Note simplified DAS adapted from De Jonge, et al., 2009, p. 36), Van der Zwart et al., 2009, p. 3. and Den Heijer, 2011, p. xv	138	5.1	Focus in this chapter Note adapted from Arkesteijn et al., 2017, p. 245	183
3.16	Added value visualized in DAS frame Note simplified DAS adapted from De Jonge, et al., 2009, p. 36), Van der Zwart et al., 2009, p. 3. and Den Heijer, 2011, p. xv	140	5.2	PAS Flowchart; emphasis on steps Note adapted from Arkesteijn et al., 2017, p. 248	184
4.1	PAS components and rationalities Note adapted from Arkesteijn et al., 2017, p. 245	152	5.3	Three areas on the TU Delft's campus Note adapted from Arkesteijn et al., 2017, p. 250 Legend: purple circles: coffee corner, pink circle restaurant; number in circle g.f.a and size of circle corresponding to size of facility. Building numbers added in squares corresponding to Table 5.1.	186
4.2	PAS development phases and the focus on the components	153	5.4	Photos food facilities continued Note photos by Arkesteijn & Valks	188
4.3	Focus in each of the PAS development phases	154	5.5	Photos food facilities continued Note photos by Arkesteijn & Valks	189
4.4	PAS development phases, pilots and publications	155	5.6	Decision makers and their variables Note adapted from Arkesteijn et al., 2017, p. 252	190
4.5	Steps as component of PAS Note adapted from Arkesteijn et al., 2017, p. 245	156	5.7	Summary of problems, objectives and decision variables student council	191
4.6	Examples of preference curves	159	5.8	Summary of problems, objectives and variables faculty secretary	193
4.7	Lagrange curve relating preference rating to percentage of buildings within the portfolio serving societal goals Note adapted from Arkesteijn & Binnekamp, 2013, p. 96	160	5.9	Summary of problems, objectives and variables for the works council	194
			5.10	Summary of problems, objectives and variables for the project leader social innovation	196

- 5.11 Comparison of unique variables (U1 to U11) to numbered variables (1 to 17) 196
- 5.12 Lagrange curve for the variable “ability to work in the food facility” (see also in Figure 5.17, variable 9); the curve represents the demand and relates the preference rating (vertical axis) to variable value (on the horizontal axis) Note adapted from Arkesteijn et al., 2017, p. 253 198
- 5.13 Preference curves works council 198
- 5.14 Preference curves student council 199
- 5.15 Preference curves faculty secretary 200
- 5.16 Preference curves project leader social innovation 200
- 5.17 Variables and coordinates of the curves relating decision variable values to preference ratings. Note adapted from Arkesteijn et al., 2017, p. 252 201
- 5.18 Maximum walking time in minutes per decision maker Note adapted from Arkesteijn et al., 2017, p. 253 201
- 5.19 The division of weights per variable, as determined by each decision maker. Note adapted from Arkesteijn et al., 2017, p. 254 202
- 5.20 Design constraints Note adapted from Arkesteijn et al., 2017, p. 254 203
- 5.21 Main interface for generating design alternatives depicting the chosen alternative. Purple circles coffee corners. Pink circles restaurants. Green circles new concept *middle* and blue circles new concept *large* Note adapted from Arkesteijn et al., 2017, p. 255 204
- 5.22 Preference score per variable; current (referred to as column D_0) and chosen design alternative (referred to as column D_1) Note adapted from Arkesteijn et al., 2017, p. 256 205
- 5.23 PFM overall preference score of the current situation and the final design (Tetra) 206
- 5.24 PFM overall preference scores and added value food facilities Note adapted from De Jonge, et al., 2009, p. 36), Van der Zwart et al., 2009, p. 3., Den Heijer, 2011, p. xv. 206
- 5.25 TU Delft, large lecture halls (160+ seats) Note adapted from Arkesteijn et al., 2015 , p. 108 Building numbers are shown in the squares. 208
- 5.26 Figure 5.25 Photos of large lecture halls continued Note photos by Valks 209
- 5.27 Relationship demand for educational space and supply of lecture halls 211
- 5.28 Tensions between teachers, E&S Affairs and FMRE 211
- 5.29 Participating stakeholders in the pilot study Note from Arkesteijn et al., 2015 , p. 109 212
- 5.30 Lagrange curve relating preference rating to the occupancy rate (criterion 32) of the university’s portfolio of lecture halls Note from Arkesteijn et al., 2015 , p. 111 213
- 5.31 Criteria and their respective preferences Note adapted from Arkesteijn et al., 2015 , pp. 110-111 213
- 5.32 The division of weights per criterion, as determined by each stakeholder Note Arkesteijn et al., 2015 , p. 112 215
- 5.33 Design constraints incorporated into the scheduling model Note adapted from Arkesteijn et al., 2015 , p. 112 216
- 5.34 Portfolio result, current and future. The numbers A-H2 correspond with the interventions named above Note from Arkesteijn et al., 2015 , p. 115 218
- 5.35 Preference score per variable; current (d_0) and future design alternative (d_1) Note from Arkesteijn et al., 2015 , p. 116 219
- 5.36 PFM overall preference score of the current situation and the final design (Tetra) 220

- 5.37 PFM overall preference scores current situation and best alternative as well as added value lecture halls Note adapted from De Jonge, et al., 2009, p. 36, Van der Zwart et al., 2009, p. 3, Den Heijer, 2011, p. xv. [221](#)
- 5.38 The process followed in [original] study Note adapted from Davenport in De Visser, 2016, p. 60 [223](#)
- 5.39 Indicators for attracting millennials Youthful-Cities in De Visser, 2016, p. 61 [225](#)
- 5.40 PFM overall preference scores current situation and optimum design (step 5a) and global optimum (step 5b) as well as added value office locations Note adapted from De Jonge, et al., 2009, p. 36, Van der Zwart et al., 2009, p. 3, Den Heijer, 2011, p. xv. [228](#)
- 5.41 Comparison PAS and original scorecard study Note adapted from de Visser, 2016, p. 75 [229](#)
- 6.1 Focus on PAS component stakeholders & activities Note adapted Arkesteijn et al., 2017, p. 245 [236](#)
- 6.2 Flowchart of PAS; emphasis on stakeholders & activities Note adapted Arkesteijn et al., 2017, p. 248 [237](#)
- 6.3 Main design interface Note from Arkesteijn et al., 2017, p. 250 [239](#)
- 6.4 Main design interface displaying the chosen alternative Note from Arkesteijn et al., 2017, p. 255 [240](#)
- 6.5 Intervention interface (a) on the left without pull down menu and (b) on the right with pull down menu open [241](#)
- 6.6 Design information per stakeholder and per design variable [243](#)
- 6.7 Design information per stakeholder and per design variable [243](#)
- 6.8 Enriched input interface [244](#)
- 6.9 Input interface with overview per stakeholder of step 1 to 3 [245](#)
- 6.10 Impression second workshop [246](#)
- 6.11 Two alternative designs (alternative 1 on top, alternative 2 at the bottom) [247](#)
- 6.12 Iteration between interviews (requirements) and workshops (alternatives). A green arrow means that the criterion was incorporated in the model; a red arrow means that it was not incorporated in the model. A box with the letter "A" in it means that a criterion was adjusted in an interview. [248](#)
- 6.13 Main design interface [251](#)
- 6.14 Intervention interface [252](#)
- 6.15 Interface step 1 assessing the current campus; DAS frame [255](#)
- 6.16 Intervention interface step 2 exploring changing demand; portfolio level showing current situation [256](#)
- 6.17 Interface step 2 exploring changing demand; portfolio level [258](#)
- 6.18 Interface step 2 exploring changing demand; match [259](#)
- 6.19 Object Data [261](#)
- 6.20 Design information per stakeholder per criterion [262](#)
- 6.21 Design information per stakeholder per constraint [263](#)
- 6.22 Interface assessing the current campus; overview of requirements (step 1 to 4) [263](#)
- 6.23 Impression second workshop first assignment Note from Valks, 2013, p. 65 [265](#)
- 6.24 Iteration between requirements and alternatives Note from Arkesteijn et al., 2015, p. 117 SR stands for student council, C stands for criterion, RV for boundary condition [266](#)
- 6.25 Main design interface Note from De Visser, 2016, p. 71 [268](#)
- 6.26 Input interface with overview per stakeholder of step 1 to 3 Note from De Visser, 2016, p. 67 [269](#)

- 6.27 Iteration between requirements and alternatives Note from De Visser, 2016, p. 93 [272](#)
- 6.28 Overview of interfaces [274](#)
- 6.29 Comparison of the information provided in the user interfaces [276](#)
- 7.1 Focus on PAS component mathematical model Note adapted from Arkesteijn et al. 2017, p. 245 [280](#)
- 7.2 PAS flowchart with emphasis on mathematical models Note adapted from Arkesteijn et al. 2017, p. 248 [281](#)
- 7.3 Feasible states per food facility (grey = infeasible and green = feasible) [283](#)
- 7.4 Feasibility of the state vector (red = infeasible and grey = feasible) [293](#)
- 7.5 Models' structure; combining PAS and LP Note adapted from Valks, 2012, p. 54. In the two upper figures a constraint is modified to enlarge the set of feasible solutions; in the two lower figures the grey areas depict the overall preference score of the alternatives and enables the decision maker to choose the best one. The circle depicts the best alternative in LP given the objective (OBJ). [295](#)
- 7.6 Model structure overall preference score Note adapted from De Visser, 2016, p. 70 [298](#)
- 7.7 Model structure individual location preference score Note adapted from De Visser, 2016, p. 71 [298](#)
- 8.1 Positive aspects and areas of improvement of PAS visualized. Legend: Each circle line represent a pilots, with the third pilot at the outer edge. A full line means an aspect was mentioned; a dotted line it was not. A green line means an aspect evaluated positively, an orange line indicates a possible improvement. The grey ovals group related aspects. [325](#)
- 9.1 PAS (indicated with dotted lines) implemented in DAS Note from Arkesteijn et al., 2017, p. 261 and DAS from Den Heijer, 2011, based on De Jonge et al. 2009 [330](#)
- 9.2 PAS steps (indicated with black dotted lines) implemented in Alignment model (Edwards & Ellison, 2003, p. 18) © Used with permission. All rights reserved. No part of this publication may be reproduced, stored in a retrieval system, or transmitted, in any form or any means, electronic, mechanical, photocopying, recording or otherwise, except as permitted by the UK Copyright, Designs and Patents Act 1988, without prior permission of the original publisher. Note Figure from Arkesteijn et al., 2017, p. 261 [331](#)
- 9.3 Design methodology for PAS steps 1 to 3 ordered by stakeholder [332](#)
- 9.4 PAS steps 1 to 3 ordered by decision variables [333](#)
- 9.5 PAS step 4 ordered by decision variables (Table with turned direction for readability; original Table added at next page to be used in digital version) [334](#)
- 9.6 PAS step 4 a designed alternative with overall preference score ordered by decision variables [336](#)
- 9.7 Type of system Note adapted from De Leeuw, 2002, p. 103 [340](#)
- 9.8 Relationship between the four PAS management subsystems [341](#)
- 9.9 PAS set up subsystem [343](#)
- 9.10 Reticulation of programming subsystem [345](#)
- 9.11 PAS programming subsystem [346](#)
- 9.12 Flowchart programming subsystem [348](#)
- 9.13 Reticulation of modeling subsystem [349](#)
- 9.14 PAS modeling subsystem [350](#)
- 9.15 Flowchart modeling subsystem [352](#)
- 9.16 Reticulation of design subsystem [353](#)

9.17 PAS design subsystem 354

9.18 Flowchart design subsystem 356

10.1 PAS Flowchart Note adapted from Arkesteijn et al. 2017, p. 248. The stakeholders & two activities, interviews and workshops are displayed in the first four columns (darkest purple), the six steps are given in the intermediate columns (intermediate purple) while the model building is presented in the last column (lightest purple). 363

Acronyms

AP	Advanced Planning team
CATWOE	Clients, Actors, Transformation, Weltanschauung, Owner, Environment
CRE	Corporate Real Estate
CREM	Corporate Real Estate Management
DAS	Designing an Accommodation Strategy
DSS	Decision Support System
FMRE	Facility Management and Real Estate
G.F.A.	Gross floor area
GUI	Graphical User Interface
HAS	Human Activity System
I	Information
IP	Input
KPI	Key Performance Indicator
LOB	Line of Business
LP	Linear Programming
MCDA	Multiple Criteria Decision Analysis
MCDM	Multiple Criteria Decision Making
OP	Output
OPS	Overall Preference Score
OR	Operations Research
PAS	Preference-based Accommodation Strategy
PBD	Preference-Based Design
PBPD	Preference-Based Portfolio Design
PFM	Preference Function Modeling
PoR	Program of Requirements
PREM	Public Real Estate Management
RLS	Real Life System
RM	Responsible Manager
S	Stakeholders
SE	System Engineer
SS	Steered System
SU	Steering Unit
TU Delft	Delft University of Technology
U	Steering measures
UDR	Urban Decision Room

Summary

One of the long-standing issues in the field of corporate real estate management is the alignment of an organization's real estate to its corporate strategy. In the last thirty years, fourteen Corporate Real Estate (CRE) alignment models have been made. In some of these CRE alignment models it is indicated that they strive for maximum or optimum added value. Even though extensive research into these existing CRE alignment models has provided us with valuable insights into the steps, components, relationships and variables that are needed in the alignment process, these models still fall short in two ways. Most models pay little to no attention to

- 1 The design of new CRE portfolios;
- 2 The selection of a new CRE portfolio that adds most value to the organization.

How a CRE manager is able to design and select an optimum alternative in an operational way remains a black box in many alignment models.

In CRE alignment models, the authors generally use either the stakeholder or the shareholder approach. Both approaches received criticism in the past. Kaplan and Norton (2006) state that the shareholder approach with purely financial measures of performance are not sufficient to yield effective management decisions. Jensen (2010) criticizes the stakeholder approach and states that managers in an organization need to define what is better and what is worse which forms the basis of making decisions. In his view, putting them in opposite positions is not correct because both are of a different nature. In fact, Jensen (2010, p. 33) states " ... whether firms should maximize value or not, we must separate two distinct issues;

- 1 Should the firm [organization] have a single-valued objective?;
- 2 And, if so, should that objective be value maximization or something else ...?"

I agree with Jensen's view that a single-valued objective function is needed, but argue that in our CREM domain a financial measure is not fully suitable. A financial measure is not suitable, because values (also referred to as qualities) of buildings fall in two general categories.

These categories are often interrelated and overlap in practice as explained by Volker (2010, p. 17), the categories are:

- “technical, physical, hard, functional, objective or tangible qualities;
- perceptual, soft, subjective, judgmental or intangible values.”

These intangibles are vital to CRE management but often suppressed. Real estate decision making therefore needs to be able to include all of these values in order to be purposeful. If they are treated separately, the restriction is that one effect can be more difficult to monetize than the other effect, as shown by Mouter (2012) and if multiple measures are used as in the stakeholder approach “if you take one set of quantifiable impacts and one set of non-quantifiable impacts in an appraisal, one set will dominate” (Mishan, in Mouter, 2012, p. 10).

Research aim: The aim of this research is to enhance CRE alignment by improving CRE decision making in such a way that corporate real estate managers are able to determine the added value of a particular corporate real estate strategy quickly and iteratively design many alternative real estate portfolios.

Conclusions about developing the Preference-based Accommodation Strategy design and decision approach

This research successfully developed, tested and evaluated a new design and decision approach in corporate real estate alignment that makes it possible to design alternative CRE portfolios and then to select the portfolio that adds most value to the organization. The originality of this research to (1) define value as technically equivalent to preference and (2) use a design and decision approach for the alignment problem. This new approach is called the Preference-based Accommodation Strategy design and decision approach (PAS). PAS was developed and tested in accordance with the five stages of an operations research project. PAS is constructed upon fifteen basic concepts and definitions from management science, decision theory and design methodology.

Preference Measurement and Preference-Based Design are the most important basic concepts. By using the overall preference (value) score as overall performance measure, based on a single-valued objective function, CRE managers are able to select a new CRE portfolio that adds the most value to the organization. Following Barzilai (2010), all tangible and intangible values are categorized either as *physical* or *non-physical properties* of an object. To enable the application of mathematical operations to these non-physical properties, such as preference, Barzilai (2010) developed a theory of (preference) measurement as well as a practical evaluation methodology

Preference Function Modeling for constructing proper preference scales. To enable the design of alternatives the Preference-based Design method (Binnekamp, 2011) is used as particular technique in the domain of design and decision systems. By adjusting this method it can be used on portfolio level.

PAS is structured around three decision making rationalities (Kickert, in De Leeuw, 2002). The three components are; the steps (procedural rationality), the stakeholders & activities (structural rationality) and the mathematical model (substantive rationality) as shown in **Figure S.1**. The *substantive rationality* enables the decision maker to choose an alternative based on the bounded rationality perspective. The *procedural rationality* enables the decision maker to take into account the time perspective when selecting an alternative and the *structural rationality* enables that more than one decision maker is involved. By using all concepts past experience has benefited the development of PAS. For PAS to be operational all components are connected coherently.

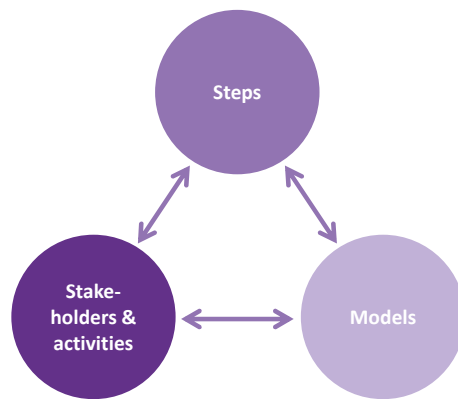

FIG. S.1 Three components of PAS Note adapted from Arkesteijn et al., 2017, p. 245

The coherence between the components is shown in a flowchart in **Figure S.2**. In the steps, decision makers define decision variables representing accommodation aspects that make the accommodation strategy tangible and iteratively test and adjust these variables by designing new alternative real estate portfolios. The alternative design that adds most value to the organization, i.e. has the highest overall preference score, is the portfolio that optimally aligns real estate to corporate strategy. The activities that the participants perform are a series of interviews and workshops, while the system engineer builds the accompanying mathematical models. The approach overcomes the problems inherent to the current models and uses explicit scales for measuring preference, i.e. value, defined by stakeholders themselves.

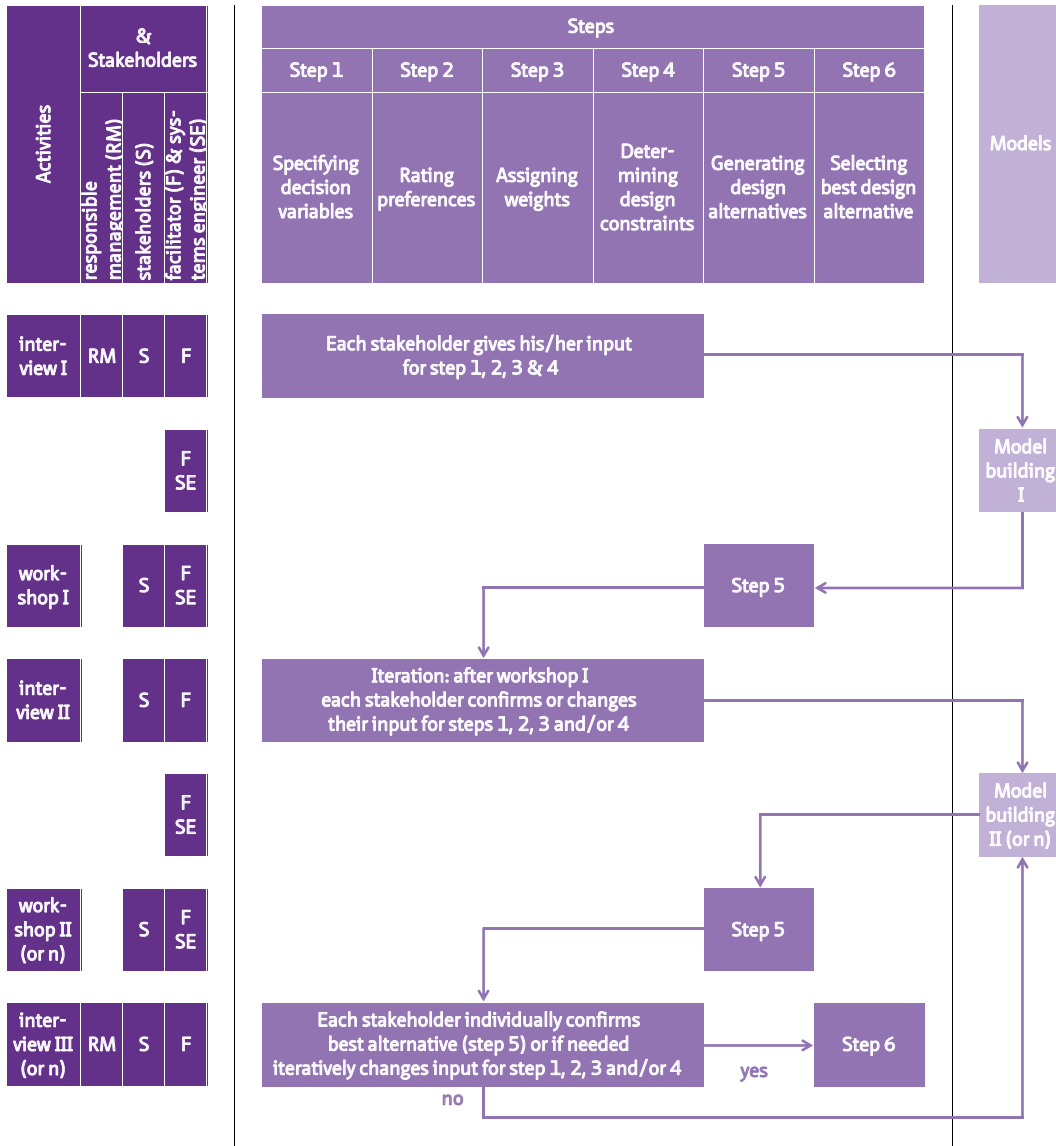

FIG. S.2 PAS Flowchart Note adapted from Arkesteijn, et al., 2017, p. 248

Conclusions about testing PAS

PAS is tested successfully in three pilot studies. All pilot studies show that the stakeholders were able to perform all the steps and activities, including the steps to determine preference curves (step 2) and the design alternatives themselves

(step 5). The stakeholders were able to design an alternative CRE portfolio with a higher overall preference than in the current situation **Table S.1**. An added value of 54, 17 and 5 (out of a 100) was achieved either by the stakeholders (in step 5a) or the optimization tool (in step 5b). In the last step, all stakeholders accepted that alternative as the final outcome. Next to that, there is an indication, based on the third pilot study, that the use of the preference curves in PAS improved the representation of the stakeholders preferences than in their current scorecard system.

In the first and third pilot, alternative CRE portfolios have been generated with an optimization tool (step 5b). Due to the nature of third pilot the brute force approach was used successfully in generating a global optimum (see **Table S.1**). In the first pilot, the algorithm (step 5b) was not able to generate a local optimum because a subset of the alternatives was infeasible. The feasible set of alternatives could not be characterized mathematically and was not available to the algorithm. The brute force approach is preferable to the search algorithm as it finds a global optimum instead of a local optimum but has as disadvantage that it often cannot be used when a pilot is too complex. In PAS, stakeholders design alternatives (step 5a), and use the PFM algorithm to rate them as has been done for the first two pilots.

TABLE S.1 Pilot comparison most added value chosen design alternatives (step 5a and 5b)

Results (based on PFM algorithm)	1 st pilot study food facilities TU Delft	2 nd pilot study lecture halls TU Delft	3 rd pilot study office locations Oracle
Overall preference score current portfolio	41	53	61
Overall preference score design alternative	95 (step 5a)	70 (step 5a)	66 (step 5b)
Added value	54	17	5

Conclusions about evaluating PAS; iteration is the key

In all three pilots the stakeholders as well as the observers evaluated PAS very positively. According to the stakeholders, determining preferences and refining and adjusting them in collective workshops is the attractive part of PAS.

The participants indicated that, whilst the method of determining preferences is easy, accurately determining which preference is related to a certain decision variable value is not. Assigning preference scores to decision variable values can be arbitrary at first. By repeating the cycle of determining preferences and making designs a number of times, the stakeholders see the effect of the decisions made in the design, and how their preferences affect those decisions. In all pilot studies the decision makers used the opportunity to either add or remove decision variables and change curves, weights or constraints. The use of such a learning process in the context of work practice and problem solving is described by Schön (1987) as reflection in action.

Conclusions about reflecting upon PAS

PAS as design and decision approach can be used as add-on to existing CRE alignment management models. However, using PAS as add-on in these models creates methodical difficulties. The structure of these models is often not congruent with the PAS structure. To avoid these difficulties, PAS is also described both from a systems' management perspective (De Leeuw, 2002).

The three pilot studies showed that PAS can be applied in different organizations, and for different types of problems with a different level of complexity. In comparison, the first two pilots were more complex because more stakeholders were involved and more interventions were possible. Applying this approach to multiple context-dependent cases has yielded more valuable results than just applying it to one case. Based on the results of this study, it is justified that PAS can be used for a wide range of real estate portfolio types.

Samenvatting

Een slepend vraagstuk op het gebied van strategisch vastgoedmanagement is de afstemming van de vastgoedportefeuille op de bedrijfsstrategie: hoe kan het vastgoed bijdragen aan de doelstellingen van de organisatie? In de afgelopen dertig jaar zijn er veertien modellen gemaakt voor de aanpak van deze afstemmingsproblematiek, een problematiek die in het algemeen bekend staat onder de Engelse term Corporate Real Estate (CRE) alignment. In sommige van de CRE-afstemmingsmodellen wordt aangegeven dat gestreefd wordt naar maximale of optimale toegevoegde waarde. Uitgebreid onderzoek naar deze bestaande CRE-afstemmingsmodellen heeft waardevolle inzichten opgeleverd in de stappen, componenten, relaties en variabelen die nodig zijn in het afstemmingsproces. Echter deze modellen schieten in het algemeen op twee punten tekort. De meeste modellen besteden weinig tot geen aandacht aan:

- 1 Het ontwerp van nieuwe CRE-portefeuilles;
- 2 De selectie van een nieuwe CRE-portfolio die de meeste waarde toevoegt voor de organisatie;

Hoe de CRE manager operationeel een alternatieve CRE portefeuille kan ontwerpen en het alternatief met de optimale toegevoegde waarde kan kiezen blijft in veel modellen een blackbox.

In CRE-afstemmingsmodellen wordt meestal gekozen om óf de aandeelhouderswaarde (shareholder) centraal te stellen, óf uit te gaan van de wensen en behoeften van de direct belanghebbenden (stakeholder). Beide benaderingen hebben in het verleden kritiek gekregen. Kaplan en Norton (2006) stellen dat de aandeelhoudersbenadering met puur financiële prestatie maatstaven niet voldoende is om effectieve managementbeslissingen te nemen. Jensen (2010) bekritiseert juist de benadering die uitgaan van het betrekken van de direct belanghebbenden in de organisatie en stelt dat managers in een organisatie moeten definiëren op basis van welke criteria de beslissingen dienen te worden genomen. Naar zijn mening dienen beide bovengenoemde benaderingen niet tegenover elkaar gezet te worden, omdat ze verschillend van aard zijn. Feitelijk stelt Jensen (2010, p. 33): "... of een organisatie waarde dient te maximaliseren of niet, het van belang is twee afzonderlijke vragen te onderscheiden;

- 1 Moet de onderneming [organisatie] gericht zijn op het nastreven van een zogenaamde 'single-valued objective'¹?
- 2 en, zo ja, zou dat doel dan waarde-maximalisatie moeten zijn of iets anders ?"

Ik onderschrijf Jensen's opvatting dat een 'single-valued objective' nodig is, maar ben ook van mening dat in ons CREM domein een financiële maatstaf alleen, geen volledig beeld van 'waarde' geeft. Een financiële maatstaf schiet tekort voor het beschrijven van de waarde van een vastgoedportefeuille of een gebouw, omdat de gangbare opvattingen uitgaan van twee categorieën die deze waarde of kwaliteiten beschrijven. Deze categorieën zijn vaak met elkaar verbonden en overlappen elkaar in de praktijk, zoals uitgelegd door Volker (2010, p. 17):

- "Technische, fysieke, harde, functionele, objectieve of tastbare kwaliteiten (ook wel eigenschappen);
- Perceptuele, zachte, subjectieve, oordelende of ongrijpbare waarden".

Met name subjectieve waarden zijn essentieel voor CRE management, maar worden in besluitvorming over vastgoed vaak verdrongen door de 'hardere' criteria. Deze zachtere waarden moeten daarom in de besluitvorming meegenomen worden. Echter, als zachtere en hardere factoren afzonderlijk worden beschouwd, is de beperking dat sommige effecten gemakkelijker in geld zijn uit te drukken of op andere wijze te kwantificeren zijn dan andere, zoals Mouter (2012) laat zien. Als er verschillende maatstaven gebruikt worden, zoals in de stakeholder-benadering, gebeurt het volgende "Als je een beoordeling of afweging baseert op een set van zowel kwantificeerbare effecten als ook niet-kwantificeerbare effecten, dan zal één set die beoordeling overheersen en bepalen" (Mishan, in Mouter, 2012, p.10).

Doel van het onderzoek: Het doel van dit onderzoek is om de afstemming van de vastgoedportfolio op de bedrijfsstrategie (CRE alignment) te verbeteren door CRE-managers in staat stellen bij de besluitvorming over strategische vastgoedbeslissingen de toegevoegde waarde van een bepaalde vastgoedstrategie snel te bepalen en in dit proces op iteratieve wijze veel verschillende alternatieve CRE portefeuilles te ontwerpen.

¹ Dit begrip wordt in paragraaf 3.1.3. nader toegelicht

Conclusies over de ontwikkeling PAS

Dit onderzoek ontwikkelde, testte en evalueerde met succes een nieuwe aanpak voor het besluitvormingsproces voor strategisch vastgoedmanagement. Met die aanpak wordt het mogelijk om alternatieve CRE portefeuilles te ontwerpen en daaruit vervolgens de portefeuille te selecteren met de grootste toegevoegde waarde voor de organisatie. De originaliteit van dit onderzoek zit in de keuze om (1) het begrip 'waarde' te definiëren als het technisch equivalent van 'voorkeur' en (2) een ontwerp- en beslissingsaanpak te gebruiken voor het afstemmingsprobleem. De aanpak kreeg de naam PAS: een op voorkeur gestuurde aanpak van het ontwerp- en besluitvormingsproces ten behoeve van de ontwikkeling van een huisvestingsstrategie. Door de totale voorkeursscore te gebruiken als algemene prestatie maatstaf kunnen CRE-managers een nieuwe CRE-portefeuille selecteren met de hoogste toegevoegde waarde voor de organisatie. PAS werd ontwikkeld en getest in overeenstemming met de vijf fasen van een operationeel onderzoeksproject. PAS is gebouwd op vijftien methodische basisconcepten en definities uit managementwetenschap, besluitvormingstheorie en ontwerpmethodologie.

Van de vijftien basisconcepten die aan PAS ten grondslag liggen, zijn Preference Measurement ('Voorkeursmeting') en Preference-Based Design ('op voorkeuren gebaseerd ontwerpen') de belangrijkste. In dit onderzoek worden in navolging van Barzilai (2010) alle tastbare en immateriële waarden gecategoriseerd als fysieke of niet-fysieke eigenschappen van een object. Om wiskundige bewerkingen op deze niet-fysieke eigenschappen, zoals voorkeur, mogelijk te maken, heeft Barzilai (2010) een (voorkeur)meettheorie ontwikkeld, evenals een praktische evaluatiemethode (Preference Function Modeling) voor het construeren van juiste schalen om voorkeur te bepalen en meten. Om het ontwerpen van alternatieven mogelijk te maken, wordt de specifieke methode voor op voorkeuren gebaseerd ontwerpen (Preference-based Design Method) van Binnekamp (2011) uit het domein van de ontwerp- en besluitvorming gebruikt. Deze methode is aangepast om hem op vastgoedportefeuilleniveau te kunnen gebruiken.

PAS is gestructureerd rond drie besluitvormingsrationaliteiten (Kickert, in De Leeuw, 2002). De drie componenten zijn de stappen (procedurele rationaliteit), de stakeholders & activiteiten (structurele rationaliteit) en het wiskundige model (inhoudelijke rationaliteit) zoals weergegeven in **Figuur S.NL.1**. De inhoudelijke rationaliteit stelt de beslisser in staat om een alternatief te kiezen op basis van het begrensde rationaliteitsperspectief. De procedurele rationaliteit stelt de beslisser in staat om rekening te houden met het tijdsperspectief bij het selecteren van een alternatief en de structurele rationaliteit maakt het mogelijk dat meer dan één beslisser betrokken is.

De ontwikkeling van PAS heeft geprofiteerd van de ervaringen die reeds zijn opgedaan met deze drie concepten in het verleden. Om PAS operationeel te maken, zijn alle componenten op samenhangende wijze verbonden.

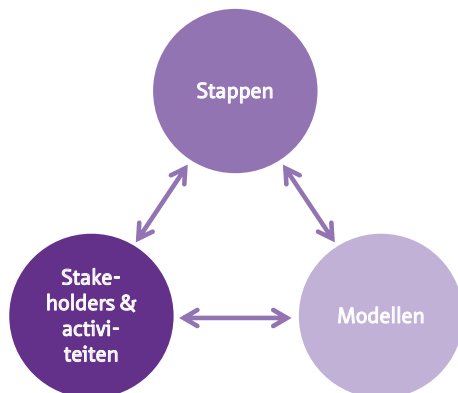

FIG. S.NL.1 Drie componenten van de PAS Noot aangepast van Arkesteijn et al., 2017, p. 245

De samenhang tussen de componenten wordt weergegeven in een stroomdiagram in **Figuur S.NL.2**. In de stappen definiëren besluitvormers de beslissingsvariabelen of criteria die huisvestingstrategie concretiseren en op iteratieve wijze worden deze criteria getest en aangepast in het ontwerpproces om te komen tot nieuwe, mogelijke vastgoed portefeuilles. Het alternatieve ontwerp dat de meeste waarde toevoegt aan de organisatie, d.w.z. de hoogste totale voorkeursscore heeft, is de vastgoedportefeuille die het meest optimaal is afgestemd op de bedrijfsstrategie. De activiteiten die de deelnemers uitvoeren bestaan uit een reeks interviews en workshops, terwijl de systeemingenieur de bijbehorende wiskundige modellen bouwt. Deze aanpak komt tegemoet aan de tekortkomingen van reeds beschikbare modellen en maakt gebruik van expliciete schalen voor het meten van de voorkeuren (waarden) die de belanghebbenden zelf inbrengen.

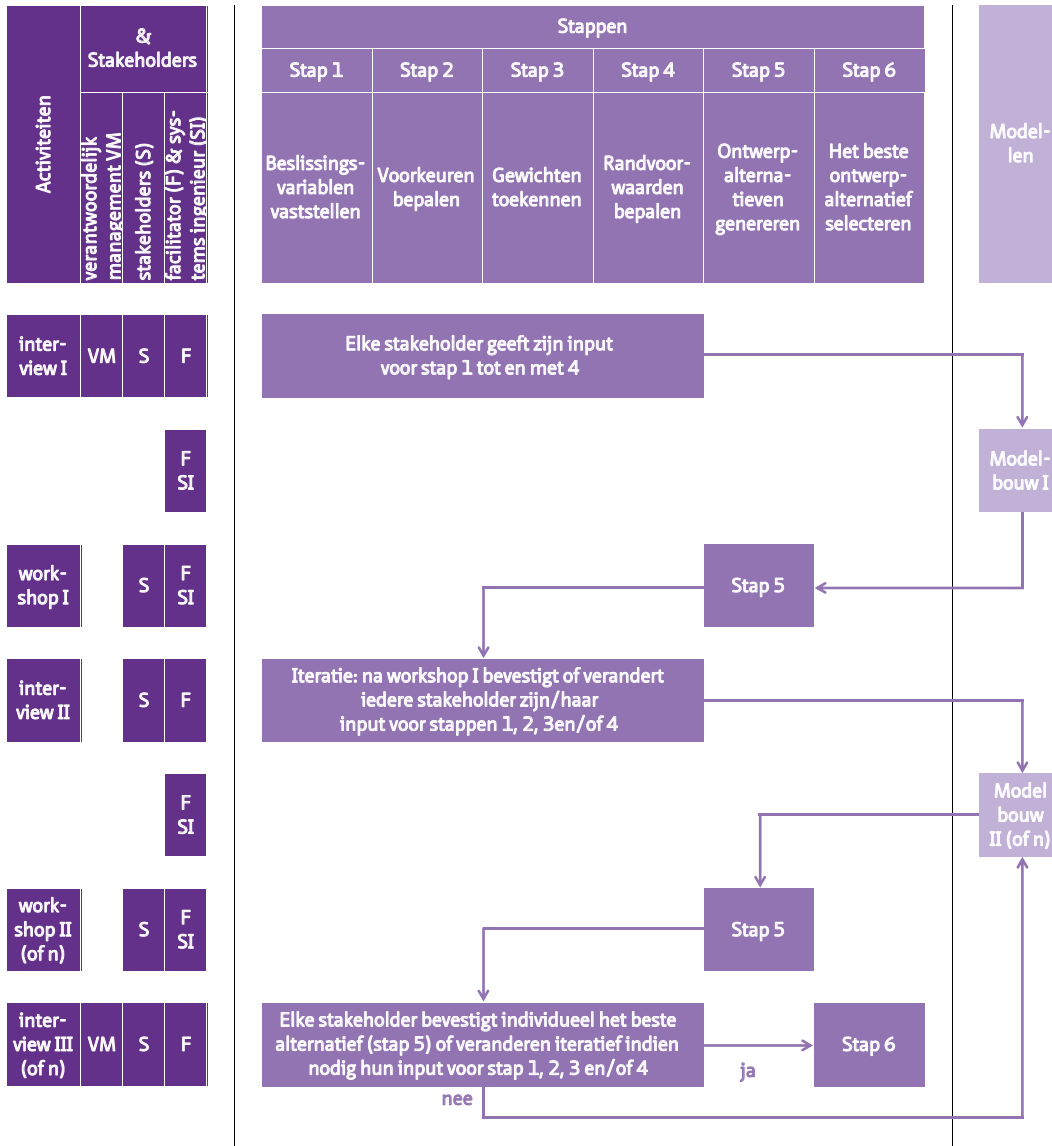

FIG. S.NL.2 Schema samenhang componenten Noot aangepast van Arkesteyn et al., 2017 p. 248

Conclusies over het testen van PAS

PAS is met succes getest in drie pilotstudies. Uit alle pilotstudies is gebleken dat de belanghebbenden in staat waren om alle stappen en activiteiten uit te voeren, inclusief de voor hen nieuwe stappen om voorkeurscurves te bepalen (stap 2) en het ontwerpen van alternatieven (stap 5). De belanghebbenden bleken met deze aanpak in staat om een alternatieve CRE-portefeuille ontwerpen met een hogere voorkeurscore dan de huidige vastgoed portefeuille (zie [Tabel NL.S.1](#)). Een toegevoegde waarde van respectievelijk 54, 17 en 5 (van de 100) werd bereikt door het genereren van alternatieven of door de stakeholders (stap 5a) of door inzet van de optimalisatie-tool (stap 5b). In de laatste stap accepteerden alle belanghebbenden dat 'beste' alternatief als het uiteindelijke resultaat. Daarnaast geeft de derde pilotstudie een indicatie dat het gebruik van de voorkeurscurves in PAS leidt tot een verbeterde weergave van de voorkeuren van belanghebbenden ten opzichte van hun huidige scorekaartsysteem.

In twee van de pilots zijn alternatieve CRE-portefeuilles gegenereerd door de inzet van een optimalisatietool (stap 5b); dit betreft de eerste en derde pilot. Vanwege de aard van de derde pilot werd hier (met succes) de brute force-aanpak gebruikt als optimalisatietool bij het genereren van een globaal optimum (zie [Tabel S.NL.1](#) hieronder). In de eerste pilot kon het algoritme (stap 5b) geen lokaal optimum genereren omdat een subset van de alternatieven niet haalbaar was. Dit betekende dat de mogelijke reeks alternatieven wiskundig niet kon worden gekarakteriseerd en daardoor niet beschikbaar was voor het algoritme. De 'brute force'- benadering heeft als voordeel ten opzichte van het zoekalgoritme dat het een globaal optimum in plaats van een lokaal optimum vindt, maar heeft als nadeel dat het kan vaak niet worden gebruikt als een pilot te complex is. In PAS ontwerpen stakeholders haalbare alternatieven (stap 5a) en wordt het PFM-algoritme gebruikt om deze te beoordelen, zoals is gedaan voor de eerste en tweede pilotstudie.

TABEL S.NL.1 Vergelijking van de toegevoegde waarde van het gekozen ontwerp in elk van de pilot studies (stap 5a en 5b)

Resultaten (gebaseerd op PFM algoritme)	1 ^e pilot studie restauratieve voorzieningen TU Delft	2 ^e pilot studie collegezalen TU Delft	3 ^e pilot studie kantoorlocatie Oracle
Totale voorkeurscore huidige CRE portefeuille	41	53	61
Totale voorkeurscore van het gekozen ontwerp	95 (step 5a)	70 (step 5a)	66 (step 5b)
Toegevoegde waarde	54	17	5

Conclusies over de evaluatie van PAS: iteratie is de sleutel

In alle drie de pilots evalueerden zowel de belanghebbenden als de waarnemers PAS zeer positief. Volgens de stakeholders is het bepalen van voorkeuren en het verfijnen en aanpassen daarvan in collectieve workshops het aantrekkelijke deel van PAS. De deelnemers gaven aan dat, hoewel de methode om voorkeuren te bepalen eenvoudig is, het nauwkeurig bepalen welke voorkeur gerelateerd is aan een bepaalde beslissingsvariabele-waarde dat niet is. Het toewijzen van voorkeurscores kan in het begin willekeurig lijken. Door de cyclus van het bepalen van voorkeuren en het maken van ontwerpen een aantal keren te herhalen, ervaren de belanghebbenden het effect van hun voorkeuren op de beslissingen die in het ontwerp beïnvloeden. In alle pilotstudies gebruikten de besluitvormers de mogelijkheid om beslissingsvariabelen toe te voegen of te verwijderen en de voorkeurscurves, gewichten of randvoorwaarden te wijzigen. Het gebruik van een dergelijk leerproces in de context van probleemoplossing in de praktijk wordt door Schön (1987) beschreven als 'reflectie in actie'.

Reflectie op PAS

PAS als ontwerp- en beslissingsbenadering kan worden gebruikt als aanvulling op bestaande CRE-afstemmingsmodellen. Het gebruik van PAS als toevoeging aan deze modellen levert echter methodische problemen op. De structuur van deze modellen is vaak niet congruent met de PAS-structuur. Om deze problemen te voorkomen, wordt PAS ook beschreven als operationeel managementsysteem (De Leeuw, 2002).

De drie pilotstudies toonden aan dat PAS kan worden toegepast in verschillende organisaties, voor verschillende soorten problemen en bij een verschillend niveau van complexiteit. Ter vergelijking: de eerste twee pilots waren complexer omdat er meer belanghebbenden bij betrokken waren en er meer interventies mogelijk waren. Het toepassen van de PAS benadering op meerdere, contextafhankelijke cases heeft meer waardevolle resultaten opgeleverd dan wanneer de benadering op slechts één pilot zou zijn toegepast. Op basis van de resultaten uit dit onderzoek is de conclusie gerechtvaardigd dat PAS kan worden gebruikt voor een breed scala aan vastgoedportfolio vraagstukken.

1 Introduction



FIG. 1.1 Faculty of Architecture and the Built Environment building (corporate real estate) © Rob 't Hart Fotografie

Corporate Real Estate

Corporate real estate is real estate that is necessary for an organization to conduct its business. CRE can be owned or leased space and is different than commercial real estate. CoreNet Global (2015) describes that in commercial real estate, real estate is core business, and the goal is to provide a risk adjusted return to the investor; whereas, in corporate real estate, real estate supports the business function. Corporate real estate represents the demand side or user side of real estate, while commercial real estate focuses on the supply side to meet that demand.

CRE function lacks tools to deliver the most business impact

Sharp (2013) concluded based on 636 survey responses that CRE teams face barriers to meet present challenges. The barriers are “C-suite resistance to capital expenditure; the sometimes small and fragmented structure of the CRE function; inadequate access to deep data and analytics to measure value; and a fundamental skill and knowledge gap within CRE teams Furthermore, many CRE departments lack the tools and training to effectively identify, shape and execute the broader business strategies that would ultimately deliver the most business impact. Only 28 percent regard themselves as ‘well equipped’ to meet the various tactical and strategic demands now being placed upon them” (Sharp, 2013, pp. 232-233).

What if CRE departments were better equipped

... with an approach that enables them to choose the best CRE strategy and portfolio design that adds most value to all stakeholders in the organization?

1 Introduction

Corporate real estate management and CRE alignment

One of the long-standing issues in the field of Corporate Real Estate Management (CREM) is the alignment of an organization's real estate to its corporate strategy. CRE alignment is even defined by some as the *raison d'être* of CREM, as the range of activities undertaken to attune corporate real estate optimally to corporate performance (Krumm, Dewulf, & De Jonge, 2000, p. 32). Aligning all of an organization's cost and value creation activities (including CREM) is important in achieving enterprise-wide value (Kaplan & Norton, 2006). This makes alignment a core technology in CREM. Alignment is often used in CREM, but in chapter 2, it becomes clear that alignment is often not defined and more complex than assumed. Even though extensive research into existing CRE alignment models has provided us with valuable insights into the steps, components, relationships and variables that are needed in the alignment process, these models still fall short in two ways. Most models pay little to no attention to the design and selection of a new portfolio that adds the most value to the organization.

Stakeholder and shareholder perspective in CRE alignment

In CRE alignment, the models' authors generally use either the *shareholder* or the *stakeholder* approach as will become clear in chapter 2. In the shareholder approach firm value is maximized and in the stakeholders approach managers make decisions that take into account all the stakeholders of the firm. Both approaches received criticism in the past. Kaplan and Norton, amongst others, state that the shareholder approach with purely financial measures of performance are not sufficient to yield effective management decision. Jensen (2010) criticizes the stakeholder approach and states that managers in an organization need to define what is better and what is worse which forms the basis of making decisions. Therefore, Jensen (2010) argues that a single-valued objective function is a needed for purposeful behavior by any organization, which the stakeholder approach lacks.

In Jensen's view, putting the shareholder and stakeholder approach in opposite positions, is not correct because both are of a different nature and complementary. In fact, Jensen (2010, p. 33) states "... whether firms should maximize value or not, we must separate two distinct issues;

- 1 Should the firm [organization] have a single-valued objective?;
- 2 And, if so, should that objective be value maximization or something else ...?"

I agree with Jensen's view that on the one hand the shareholder and stakeholder approach are complementary and on the other hand that one objective function is needed in corporate real estate, if one, indisputably, wants to measure the added value of that real estate. However, I agree with Kaplan and Norton that firm value, or any other financial measure, is unsuitable. A first objection is that a financial measure as the one objective function is not suitable in architecture and the CREM domain, because values of buildings (and thus qualities) fall in two general categories. These categories often interrelate and overlap in practice as explained by Volker (2010, p. 17):

- “Technical, physical, hard, functional, objective or tangible qualities;
- Perceptual, soft, subjective, judgmental or intangible values”.

These intangibles are vital to CREM. If these values are treated separately, the restriction is that one effect can be more difficult to quantify / monetarize than the other effect, as shown by Mouter (2012) when he discussed the disadvantages of the social cost-benefit analysis in practice. This means, as he explains, that effects are presented in an unbalanced manner. "If you take one set of quantifiable impacts and one set of non-quantifiable impacts in an appraisal, one set will dominate" (Mishan, in Mouter, 2012, p. 10).

A second and fundamental objection towards any monetary measure is that price is not a property of a physical object (Barzilai, 2015, 2016). Barzilai (2015) shows that theory can be simplified and he uses an example of buying goods at the market "As is well known, the value of money is different from money. Both Marshall's and Hicks's theories (and the intermediate ones as well) take into account consumers' preferences for tomatoes and cucumbers but ignore their preference for money. This is an elementary error in current economic theory". He further explains that "when consumers buy tomatoes and cucumbers they exchange money for goods. They must- and they do – take into account their preference for money in addition to their preference for the goods. Contradictions are avoided and the theory is simplified when this transaction is viewed as (i) an exchange of goods, (ii) with money being one of the goods, and (iii) preference for all goods is taken into account".

Most CRE alignment models pay little to no attention to the design and selection of a new portfolio that adds the most value to the organization. Even though, some CRE alignment models use a financial overall performance measure, it can be concluded that none of the models has an overall performance measure that incorporates

both quantitative and qualitative criteria. If qualitative criteria are incorporated in a performance measure often ordinal scales are used. In ordinal systems, however, only order is defined. Barzilai (2010, p. 62) states that “addition and multiplication are not applicable on ordinal scale values“ and that correct measurement is needed to enable these mathematical operations. None of the current alignment models uses correct measurement.

The aim of this research is to enhance CRE alignment by improving CRE decision making in such a way that corporate real estate managers are able to determine the added value of a particular corporate real estate strategy quickly and iteratively design many alternative real estate portfolios.

In order to overcome the restrictions of the shareholder and the stakeholder approach, in this thesis one single-valued objective is used which includes all of the abovementioned value categorizations. The solution to this problem is found in preference measurement which is the foundation of decision theory. Preference is synonymous to choice, as we choose those objects that we prefer. Barzilai (2010, p. 57) states that “The mathematical foundations of social science disciplines, including economic theory, require the application of mathematical operations to *non-physical variables*, i.e. to variables such as *preference* describe psychological or subjective properties”. From a mathematical point of view, this means that the abovementioned or other value categorizations in CRE alignment are unnecessary; only *physical* and *non-physical* properties need to be distinguished.

To use correct measurement and therewith to enable the application of mathematical operations to *non-physical* properties such as preference, Barzilai (2010) developed a theory of (preference) measurement theory as well as a practical evaluation methodology for constructing proper preference scales, Preference Function Modeling (PFM).

Using one overall performance measure in CRE alignment: value is preference

Preference as overall performance measure is able to include all value categorizations. In this thesis, following Barzilai, all physical properties are translated into non-physical properties (i.e. preference), including the preference for receiving and spending money, and aggregated into one overall preference score. By doing so, the restrictions as formulated by Barzilai (2015, 2016) and Mouter (2012) are avoided.

A design and decision approach towards CRE alignment

Using preference as overall performance measure enables the selection of a new CRE portfolio that adds the most value to the organization. However, Barzilai's PFM evaluation tool evaluates existing alternatives. Therefore, Binnekamp (2010) developed a design and decision methodology which is based on PFM. This methodology is called Preference-Based Design (PBD) and enables decision makers to design alternatives when the alternatives are not known beforehand and subsequently select the best. This PBD methodology has been successfully applied to cases at a building and area level, but, as of now, has not been applied at a portfolio level. It is necessary to convert the PBD procedure in two ways in order to use it on portfolio level. Next to that, the PBD procedure is not yet thoroughly tested in real life situations.

Originality

The originality of this research is to (1) define value as technically equivalent to preference and (2) use a design and decision approach for the alignment problem. By adjusting and expanding the Preference-Based Design procedure, as particular technique from design and decision systems, and testing it in real life situations on CRE portfolio level. This new approach is called the Preference-based Accommodation Strategy design and decision approach (PAS). PAS is a design methodology and decision support tool to remedy the identified shortcomings and thereby enhance CRE alignment.

Research question

How can the Preference-based Accommodation Strategy design and decision approach successfully be developed and tested on corporate real estate portfolio level in order to enhance CRE alignment?

Research methods

PAS was developed and tested in accordance with the five stages of an operations research project. Operations Research is a discipline that focuses on the application of analytical methods to aid decision making and solve organizational problems. The five stages (Ackoff & Sasinieni, 1968, p. 11) are:

- 1 "Formulating the problem;
- 2 Constructing the model;
- 3 Deriving a solution;
- 4 Testing the model and evaluating the solution;
- 5 Implementing and maintaining the solution".

PAS will be tested in three pilot studies because it can be argued that the application of real estate strategy design methods in practice is context-dependent. The results of using the same design method three times can be different depending on the people involved in the process, the roles and responsibilities of these people within the organization, the characteristics of the portfolio / the type of space it is applied to, etc. Applying the design method to multiple context-dependent cases yields more valuable results than just applying it to one case. PAS is considered successful if (1) the participants are able to complete each step of the procedure and (2) if the stakeholders evaluate it positively.

The PAS design and decision method is structured around three components: steps, stakeholders & activities and mathematical model(s) as will be explained in chapter 3 and as is shown in [Figure 1.2](#).

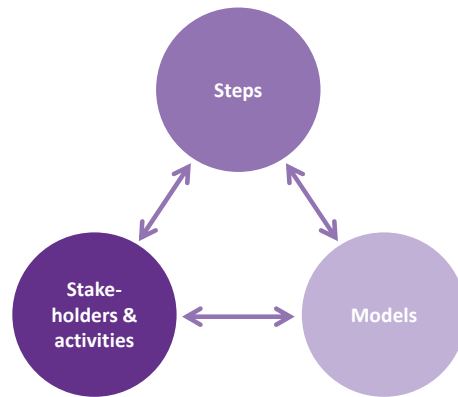

FIG. 1.2 Three components of PAS with each a different shade of purple Note adapted from Arkesteijn et al., 2017, p. 245

The development of PAS has been done in four main phases with a different focus in each of them ([Figure 1.3](#)). Whereas the components are part of the PAS design and decision method, the development phases are not. In the first development phase, the focus is on the component PAS steps. The steps of Binnekamp's PBD procedure have been further developed and tested in a proof of concept. This was necessary to make the steps applicable on CRE portfolio level. The proof of concept has been done in 2011 on the data obtained from a preliminary study at the Development corporation of the municipality of Rotterdam.

In the second development phase, PAS has been further developed and all three components were tested in two real life pilots at the Delft University of Technology (TU Delft). The first pilot focused on the real estate portfolio of food facilities (2012) while the second (2013) focused on the lecture halls.

In the third development phase, the focus shifted to PAS's three equivalent components and the relationship between them.

In the fourth development phase, two optimization tools have been used in two pilots to complement PAS.

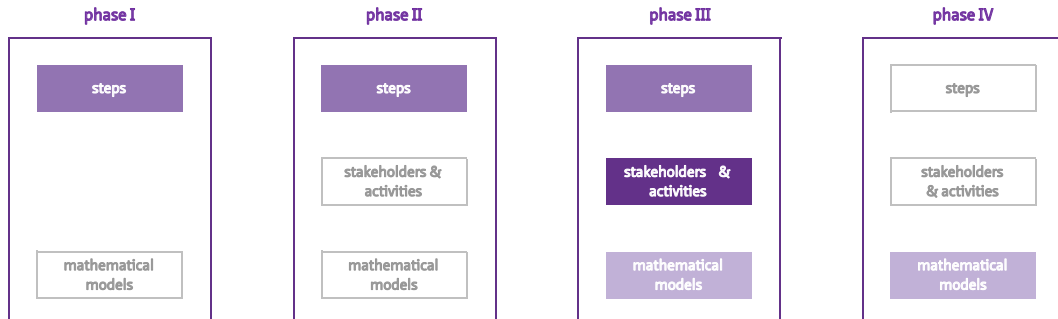

FIG. 1.3 PAS development phases and focus

Readers guide

The purpose of this thesis is to construct and test a new PAS design and decision method, that consists of many components, like designing, valuing, deciding, selecting, and steering. This has resulted in many elements and components that are used to structure the thesis. The structure of this thesis is shown in [Figure 1.4](#) and can be used as a guide.

In chapter 2, the state of the art in CRE alignment modeling is discussed to set the context of this research. It will be shown that CRE alignment is complex and multidimensional. Thereafter, an assessment of CRE alignment models from a design and decision perspective is made to substantiate the scientific gap of this research.

Subsequently, the Preference-based Accommodation Strategy (PAS) design and decision approach (PAS) is **developed** (chapter 3 and 4), **tested** (chapter 5, 6, and 7) and **evaluated** (chapter 8) and **reflected upon** (chapter 9). In the last chapter, the conclusions and recommendations are given.

chapter 2	CRE alignment state of the art and scientific gap				
Preference-based Accommodation Strategy (PAS) design and decision approach					
Developing PAS		Testing PAS			Evaluating PAS
chapter 3	chapter 4	chapter 5	chapter 6	chapter 7	chapter 8
fifteen basic concepts and definitions from decision, design and management theory	2nd procedural rationality	steps			steps
	3rd structural rationality		stake- holders & activities		stake- holders & activities
	1st substan- tive ratio- nality			model	model
chapter 9	Reflecting upon PAS				
chapter 10	Conclusions and recommendations				

FIG. 1.4 Readers guide (Note this guide is repeated at each chapter)

Developing PAS

In chapter 3, using fifteen basic concepts and definitions from management science, decision theory and design methodology, the methodological aspects, characteristics and features of PAS are outlined.

The two main concepts are Preference Function Modeling and Preference-Based Design methodology. By using these concepts past experience is incorporated in PAS for the formation of a corporate accommodation strategy.

Chapter 4 is about the development of PAS based on the fifteen components as described in chapter 3. PAS consists of three main components and is structured around them. In this chapter, each of the components; steps, stakeholders & activities, and mathematical models is discussed.

Testing PAS

PAS is tested in three pilot studies to determine if the stakeholders are able to successfully perform PAS. All components of PAS were examined described successively in chapters 5, 6 and 7.

With regard to PAS steps, chapter 5 describes and substantiates that all pilot studies show that the stakeholders were able to perform each of the steps. The stakeholders were able to design an alternative CRE portfolio with a higher overall preference than in the current situation.

Chapter 6 further explains that the stakeholders involved in completing these steps need to perform two types of activities: interviews and workshops. Since designing alternatives in the workshops is a major component of the PAS, this design process and its interactive and iterative character is explained and illustrated. This chapter shows the interfaces that the stakeholders can use when designing alternatives including instruction on how to navigate the model.

Chapter 7 shows that the system engineers were able to build a mathematical model of the problem situation for all three pilots. In the model, the group of decision makers is able to design alternatives and use the design constraints to test the feasibility of these alternatives. Per pilot, the models' structure, the models' formulas and the optimization tool is described. In two pilots an alternative CRE portfolio has been generated with an optimization tool. In one pilot a brute force approach was used, and in another pilot a search algorithm. The aim is to generate a feasible alternative with a higher overall preference score.

Evaluating PAS

In chapter 8, the evaluation of PAS is discussed. To determine if PAS is successful four types of assessments are used; firstly, the experiences of the stakeholders with PAS, secondly, whether the stakeholders find PAS attractive, thirdly the stakeholders' observations on effectiveness of PAS and fourthly the facilitators' perceptions of the effectiveness of PAS.

Reflection upon PAS as well as conclusions and recommendations

In chapter 9, PAS is reflected upon. Whereas, PAS, initially was intended as add-on to other CRE alignment in this chapter PAS is also described as independent management system. In chapter 10, the conclusions and recommendations are presented.

Now that the structure of the thesis has been explained, it is good to realize that the thesis does not necessarily need to be read from the beginning to the end. The method has been developed in an iterative process, while the results have been presented in a linear way. For readers interested in the new PAS methodology, it is recommended to start with the PAS design and decision method in chapter 4. The readers that are interested in the practical application of the method should start with the chapter 5, 6, 7. For the readers who are interested in the underlying building blocks and definitions used in the design and decision method chapter 3 is important.

It is important to notice that this thesis is a monograph and not a paper-based thesis. However, the monograph is of a hybrid form because parts of this work have been published since 2012. Therefore, I will refer to larger parts of published text, because they are important to create understanding in this thesis, but need not to be rewritten because they already have been carefully formulated. The publications follow the logic of a pilot and this thesis is (mainly) structured around the PAS components.

Visual readers guide

PAS is a design and decision method that can be used as add-on to existing CRE alignment management models. In this thesis, PAS is linked to the existing DAS frame because this CRE alignment model is developed in Delft and well-known in the FMRE pilot organization. Therefore it is used as visual guide.

DAS frame

First of all, the Designing an Accommodation Strategy frame (DAS) frame (De Jonge et al., 2009) will be used (see [Figure 1.5](#)). It is used to compare different approaches to each other (in chapter 3) and to display results (in chapter 5). DAS is a cyclic and iterative process that moves along two axes, from demand to supply and from current to future and will be introduced in chapter 2.

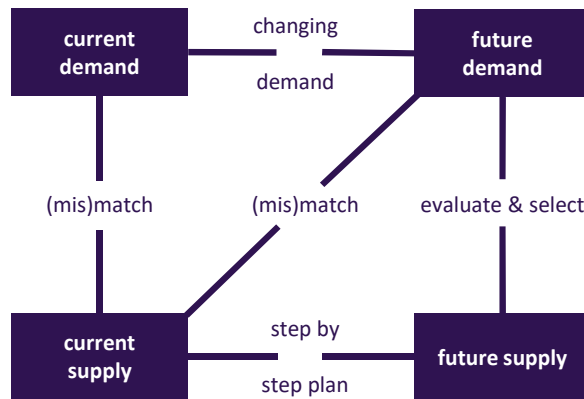

FIG. 1.5 Simplified DAS Frame
Note adapted from De Jonge, et al., 2009, p. 36, Van der Zwart et al., 2009, p. 3. and Den Heijer, 2011, p. xv.

Stakeholder perspectives

Secondly, four stakeholder perspectives that Den Heijer (2011) used in her thesis are used as visual guide. The perspectives are: policy makers, controllers, users and technical managers. Each of them is represented with its own icon and color as shown in **Figure 1.6**. These icons and colors will be used throughout the thesis to indicate to which perspective a certain stakeholder belongs to.

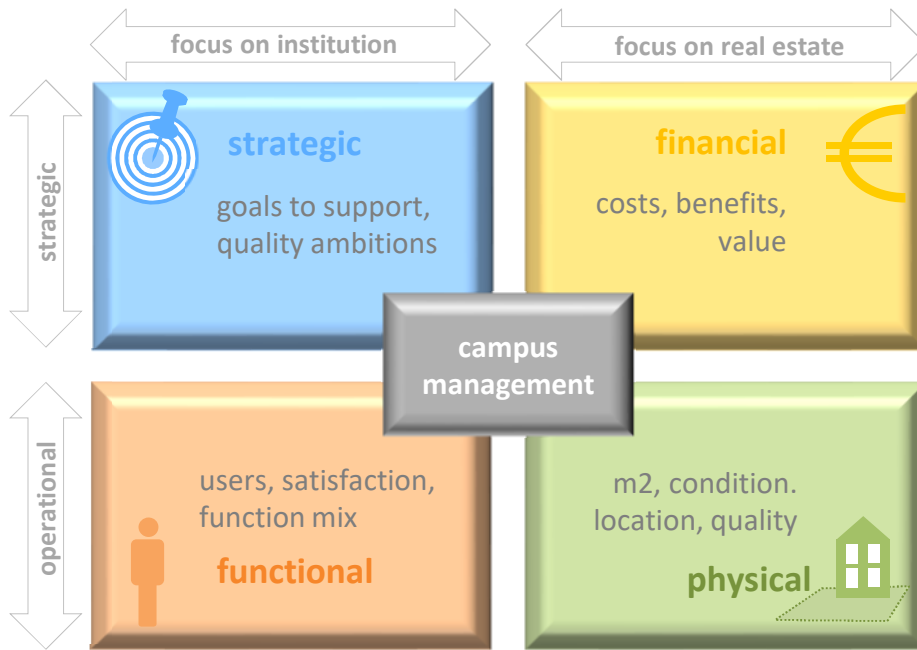

FIG. 1.6 Stakeholder perspectives Note from Den Heijer, 2011, p. xiv

In this thesis, the singular they is used as gender neutral form², especially in paragraph 4.3.2

² https://en.wikipedia.org/wiki/Singular_they

2 Corporate Real Estate alignment

chapter 2	CRE alignment state of the art and scientific gap
-----------	---

**Preference-based Accommodation Strategy (PAS)
design and decision approach**

Developing PAS		Testing PAS			Evaluating PAS
chapter 3	chapter 4	chapter 5	chapter 6	chapter 7	chapter 8
fifteen basic concepts and definitions from decision, design and management theory	2nd procedural rationality	steps			steps
	3rd structural rationality		stakeholders & activities		stakeholders & activities
	1st substantive rationality			model	model

chapter 9	Reflecting upon PAS
-----------	---------------------

chapter 10	Conclusions and recommendations
------------	---------------------------------

2 Corporate Real Estate alignment

This dissertation aims to enhance CRE alignment by approaching alignment as a design and decision process as is explained in chapter 1. The current state of the art in CRE alignment modeling is summarized in paragraph 2.1. This sets the *context* of this research and will show that CRE alignment is complex and multidimensional. Thereafter, an assessment of CRE alignment models from a design and decision perspective is made in paragraph 2.2. Based on this perspective I identified the *scientific gap* of this PhD research. Most of the work in this chapter has been published before in the last 10 years. **Figure 2.1** shows the timeline of the important publications related to the two topics that this chapter addresses:

- 1 State of the art of modelling CRE alignment processes;
- 2 Assessment of structure models of CRE alignment from a design and decision perspective.

As can be seen in the figure below, the different topics have evolved at the same time. I have chosen to structure the chapter around the two topics and not follow the order of publication. Because the topics have evolved over time this causes some redundancy in and between paragraph 2.1 and 2.2. In the last paragraph 2.3 conclusions, they are brought together.

But before showing the state of the art, CRE and CREM are defined. Corporate real estate is a specific type of real estate. CoreNet Global (2015) describes it as the real estate necessary to conduct business—the bricks and mortar of office buildings, manufacturing plants and distribution centres, retail stores, and similar facilities. It can include owned or leased space, buildings, and infrastructure, such as power plants or even airport runways. Corporate real estate is closely related to commercial real estate, however, there is a distinct difference in business objectives. In the commercial real estate world, the business is the real estate. The goal for commercial real estate is to provide a risk adjusted return to the investor; whereas, in corporate real estate real estate supports the business function. In other words, corporate real estate represents the demand side or user side of real estate, while commercial real estate focuses on the supply side to meet that need.

	2008	2009	2010	2011	2012	2013	2014	2015	2016	2017	2018
CONTEXT PhD research Comparison CRE alignment model	De Jonge et al. 1st ed. (R)	De Jonge et al. 2nd ed. (R)	Appel et al (JP)	Heywood (CP)						Heywood & Arkesteijn (JP)	Heywood & Arkesteijn (JP)
		Van der Zwart et al (CP)									
CORE PhD research Assessment CRE alignment models				start PHD research	Arkesteijn & Binne-kamp (CP)	Arkesteijn & Binne-kamp (BC)	Valks et al (CP)	Arkesteijn et al (JP)		Arkesteijn et al (JP)	

FIG. 2.1 Context and core of PhD research Note CP = conference paper JP = journal paper, R = reader, BC = book chapter and P = presentation. Dark purple cells publications (co-)author.

Corporate real estate is seen since 30 years by (Joroff, 1993) as the fifth resource of the business that needs to be managed besides capital, human resources, IT and communication. One of the big challenges in corporate real estate management is reducing the gap between the high speed of business and the slow speed of real estate, i.e. between the so-called dynamic real estate demand and the relatively static real estate supply. A decade later (Krumm et al., 2000, p. 32) described CREM as

“The management of a corporation’s real estate portfolio by aligning the portfolio and services to the needs of the core business (processes), in order to obtain maximum added value for the business and to contribute optimally to the overall performance of the corporation”.

One could say that the authors position CRE alignment in this definition as the raison d’être of CREM. Other authors (Heywood & Arkesteijn, 2017) position CRE alignment as one of the activities that CREM needs to perform. In this research, CREM will be seen as a wide range of activities that must be performed by the corporate real estate manager, while the alignment of CRE with the business will be seen as one of CREM’s activities and is referred to as CRE alignment.

2.1 Corporate Real Estate alignment an overview of the state of the art

Thorough analysis and examination of the CRE alignment theory and their alignment process models is rare. A substantial critique of these models is that each is usually presented in isolation with little if any reference to previous modeling efforts. Heywood and Arkesteijn (2017) identified 20 different models. Some examples of thorough analysis of these models are (De Jonge et al., 2008; De Jonge et al., 2009; Van der Zwart et al., 2009; Appel-Meulenbroek, Brown, & Ramakers, 2010, Heywood, 2011). The first two examined six models to overview and compare their components, the second examined eight models to adopt one to study Dutch aged care CRE. The third identified components evident in ten alignment models.

Paragraph 2.2 is about the state of the art CRE alignment and is a summary of two papers that have been written in cooperation with Heywood from the University of Melbourne which have been published. The papers present their thorough examination of CRE alignment theory and models that developed and supersede part of the work of Heywood (2011) and De Jonge et al. (2008, 2009) and Van der Zwart et al. (2009). The papers are³:

- Heywood, C., & Arkesteijn, M. (2017). Alignment and theory in Corporate Real Estate alignment models. *International Journal of Strategic Property Management*, 21(2), 144-158;
- Heywood, C., & Arkesteijn, M. (2018). Analysing fourteen graphical representations of corporate real estate alignment models. *Journal of Corporate Real Estate*, 20(1), 16-40.

This examination of CRE alignment theory and models provides a state of the art overview. The overview enables us to understand the nature of CRE alignment as a phenomenon by summarizing part of the 2017 paper. From the 2018 paper the components and building blocks of CRE alignment models will be presented.

³ The text is a summary of the two papers and relies mostly on existing text. Alterations have been made to represent the text logically in a condensed format. Therefore, I will not refer to the authors when summarizing the text. The text has been approved by Heywood.

The results of both papers are presented in the following order;

- Paragraph 2.2.1 understanding CRE alignment and definitions of CRE alignment;
- Paragraph 2.2.2 understanding the cognitive objects being aligned;
- Paragraph 2.2.3 understanding the alignment directionality;
- Paragraph 2.2.4 understanding the relationship between the business and CRE
- Paragraph 2.2.5 understanding forms of alignment;
- Paragraph 2.2.6 CRE alignment's building blocks and its constituents components;
- Paragraph 2.2.7 one of the alignment models is discussed; the DAS frame.

2.1.1 Understanding CRE alignment

Understanding CRE alignment's nature was developed by examining multiple models⁴ of, essentially, the same phenomenon. Examining multiple representations should enable an enlarged and more complete understanding of the phenomenon to be developed.

Heywood and Arkesteijn (2017) deepened the understanding of CRE alignment through a meta-study of twenty existing alignment models (see [Figure 2.2](#)). A qualitative hermeneutic method interpreted the articles and their models. This holistic analysis found alignment to be more complex and pluralistic than the individual models assumed. Four dimensions operating simultaneously were evident⁵ –multiple organizational and CRE accommodation concepts (as cognitive objects) to align, a multi-valent relationship between these objects, alignment in multiple directions and multiple alignment forms. Alignment theorization had positive and negative aspects. Positive is that good science was evident and had improved over time. Negative is that model theorization had occurred mostly in isolation and was constrained by simplifications required to make modeling tractable. The research makes a meta-theoretical contribution through a more complete theorization of CRE alignment as a phenomenon. This addresses a disordered sense to prior theory, thereby representing a major conceptual improvement. A new alignment model is not proposed; rather through developed understanding a basis is provided to point towards how good alignment models can treat the four dimensions.

⁴ In this study models aligning CRE and organizational strategy were selected that were a diagrammatic, real estate-based model and an associated textual material in an 'article'.

⁵ In this chapter the order in which the four dimensions are presented is changed

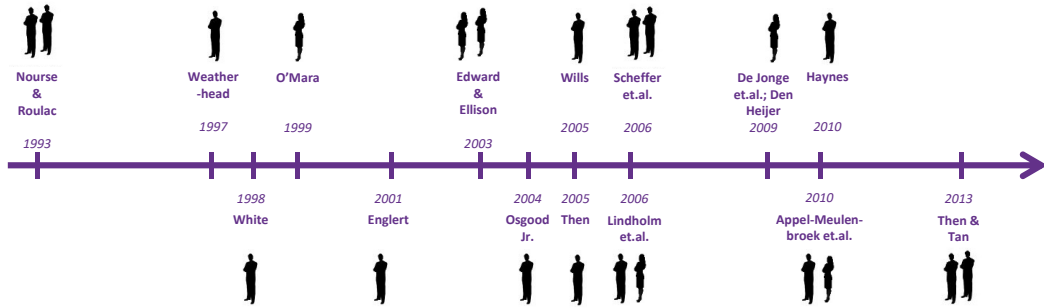

FIG. 2.2 Timeline of CRE alignment authors (Arkesteijn & Heywood, 2013)

They conclude that very few articles specifically define alignment. Then & Tan (2013) assemble several quotes from Kaplan and Norton (2006) to infer a definition because Kaplan and Norton do not actually provide one. Englert (2001) provides an important definition highlighting the vertical alignment between organizational and CRE strategies, and horizontal alignment across the business units. The models from TU Delft rely on the definition Krumm et al. (2000) of CREM that includes alignment in CREM's raison d'être.

2.1.2 Understanding the cognitive objects being aligned

In understanding CRE alignment it is important to know what is being aligned, because part of CRE alignment theory's evident disorder is attributable to the various cognitive objects⁶ that the articles say should be aligned. The analysis showed six distinct cognitive objects – three business-related ones and three real estate-related ones as are shown in [Figure 2.3](#) (Heywood & Arkesteijn, 2017). This provides a wider range of objects than displayed in Krumm et al. (2000)'s definition of CREM.

While all the cognitive objects appear relevant to CRE alignment, they are different and need to be more clearly recognized as such. This distinction was not always evident in this analysis which places strategy (business and CRE) as pre-eminent concepts, as informed by strategic management theory. In business, this pre-

⁶ This paper uses 'cognitive objects' as the concepts that are the focus of knowledge production efforts. 'Objects' recognizes that these have a formal existence, albeit one that is a product of, or contained within, mental (cognitive) efforts (Whitley, 2000)

eminence is based on strategy responding to internal and external contexts, drivers and resources, producing performance and also creating the 'needs'. In CRE, the strategy produces the CRE objects and the CREM practices. This suggests that CRE and business strategies are the primary alignment objects, with the others being secondary and consequential alignment. Nevertheless, all cognitive objects need alignment, suggesting that alignment's proper conceptualization requires all cognitive objects be included. It was also evident that, based on the six cognitive objects, nine permutations were possible with different authors using one of more permutations of the entities to be aligned.

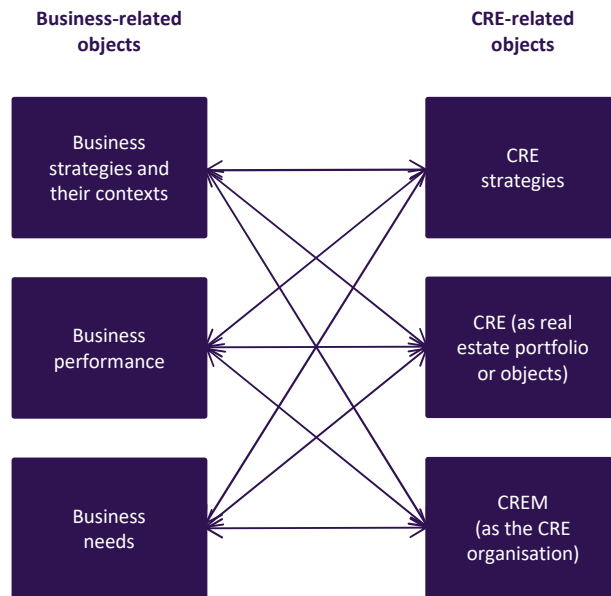

FIG. 2.3 Business and CRE-related cognitive objects in the alignment models Note adapted from Heywood & Arkesteijn, 2017, p. 150

2.1.3 Understanding the alignment directionality

Englert's (2001) alignment definition notes its multi-directionality; vertically between corporate and CRE strategies and horizontally across the business units and across the Corporate Infrastructure Resources (CIR) (Dunn et al., 2004; Materna & Parker, 1998). De Jonge et al. (2009) refer to a multi-stakeholder approach indicating different directions. This multi-directionality contrasts with the often-made assumption of CRE strategy just following corporate strategy. Although, this is important CRE alignment is multi-directional, that is, iteratively vertically between the organizational and functional levels, horizontally across the business units and the corporate infrastructure functions, and between demand and supply. This supply may be available from the existing portfolio or sourced externally from the real estate market. Five nested directions are identifiable as shown in [Table 2.1](#) (Heywood & Arkesteijn, 2017).

TABLE 2.1 Alignment directionality Note adapted from Heywood and Arkesteijn, 2017, p. 151

Direction	Variants
Internal vertically	Top-down driven - the usual conception.
	Bottom-up - corporate strategy informed about CRE.
Internal horizontally	Across the business units for a coherent portfolio approach.
	Together with other support infrastructures.
Externally	Organizational demand and availability of supply in the real estate market.

Many models contained top-down vertical alignment corresponding to conventional wisdom that CRE strategy is linked to corporate strategy, being derived from and consistent with it. Bottom-up vertical alignment was less evident and when evident it was more in terms of supporting the business strategy. Internal alignment was by-and-large the modelling's focus and explicitly considers current and future demands for CRE from the current and future portfolios. External alignment refers to the external real estate market's satisfaction, or not, of the CRE requirements by way of availability, quality, quantity, cost, location, and technology (Osgood Jr, 2004).

2.1.4 Understanding the multi-valent relationship between the business and CRE

A multi-valent relationship between CRE and the business was clear with many words used to capture different values. A value hierarchy was evident suggesting that higher value words are more important in theorizing and describing alignment. However, alignment is not one of these things, it is many or all of them as is displayed in [Table 2.2](#) (Heywood & Arkesteijn, 2017).

Interpretive examination of the words for the relationship reveals, based on their semantic qualities, a hierarchy of meaning. This revealed a multi-valent relationship (that is, multi-valued or strength) with a hierarchy of significance within the relationship ([Table 2.2](#)). Plotting the analysis this way shows a semantic progression from lesser to stronger and more valuable connection levels within the synonyms' multiple value senses. At the lower end there is 'just' having a relationship and two derivation-related links where corporate strategy 'informs' CRE strategy allowing the latter to be 'derived' from the former. At the upper end there is a utility relationship where the CRE strategy is 'useful' to, and even better, actually 'strengthens' corporate strategy. In between are the words that have to do with the relationship's closeness, that is, the two are 'consistent', 'integrated', and have 'moved' closer together. To ascertain the degree of proximity 'assessment' is required. Outcomes of that assessment are likely to lead to conclusions about the utility of CRE strategy.

TABLE 2.2 Alignment' words and their relationships' semantic quality. Note adapted from Heywood and Arkesteijn, 2017, p. 147

Words	Relationship's semantic quality and valency	Number of authors
Linked	A relationship exists between the two concepts	8
Informed	An awareness-based relationship.	1
Follow, Derived	A derivation-based relationship.	4
Coherent, Align , Moving (together), Synchronized	A consistency-based relationship.	10
Incorporate, Integrated	An integration-based relationship.	6
Align, Moving (together), Synchronized	A movement-based relationship.	7
Correctly applied, Value-maximizing, Match/Mismatch, Appropriate, Conflict absence	An assessment-based relationship.	7
Effective, Optimal (CRE solutions, contribution, balance), Value-adding	A usefulness-based relationship.	8
Support, Value-creating, Value-adding, Value-maximizing, Reinforce, Plays a role , Enable	A strengthening-based relationship.	10

There is a sense in some articles and models that just ‘deriving’ CRE strategy from business strategy is enough. While this needs to be done, it does not fully capture (Weatherhead, 1997) inference of a strengthening quality through corporate strategy that includes (corporate) real estate. This two-way relationship is important in achieving strategic CREM and is of a higher order than deriving CRE strategy. When verbalizing CRE strategy it would be better to use higher level words. It was evident that patterns of word usage did not vary much over time though recent years has seen ‘value-added’ quite widely used.

2.1.5 Understanding forms of alignment

When trying to understand alignment’s existence within the models, it was evident that different things are meant. First is understanding alignment’s forms or modes of existence in the models. Conceptually, the business alignment literature identifies three alignment forms – two noun forms (a state of being, and a strategy or plan) and a verb (a set of actions that make up a process) (Kaplan & Norton, 2006; Labovitz & Rosansky, 1997). These provided an initial thematic framework with which to analyze the articles. Additionally, interpretation needs to be open to the presence of alternative or additional themes, which resulted in one emergent one. The four forms are shown in **Figure 2.4** (Heywood & Arkesteijn, 2017) and are:

- A defined *strategy* or *plan* for alignment which can be inferred as existing as a document making it some type of artefact;
- A *process* which is defined as a set of actions or the management tasks to achieve greater alignment;
- A *state* which is the degree of alignment, now or in the future. It refers to how ‘much’ alignment is achieved; and
- *Behavior* which is having a strategic mind-set as an emergent form suggested by (O’Mara, 1999) and was informed by (Joroff, 1993) ‘Business strategist’ inferring the importance of strategic-oriented behavior. While a mind-set is a cognitive state, having it constitutes behavior, that could prove instrumental in achieving strategic outcomes when faced with a flood of operational and tactical pressures.

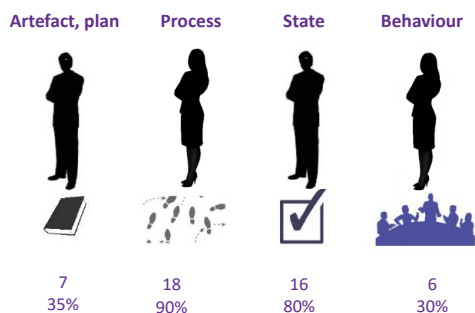

FIG. 2.4 Forms of alignment
 Legend: number of authors and % of total authors that mention the alignment form. Note adapted from Heywood & Arkesteijn, 2017, p. 147

The models combining multiple alignment forms suggest two distinctly different CRE alignment types. First is a 'process-based' type where a model provides a series of steps, a plan for greater alignment and/or a state of greater alignment for individual CRE objects or the portfolio as a whole. A process is useful and constitutes an explanation of what is otherwise hidden behind the professional expertise that is prevalent in current CREM practice. The second type is 'behavior-based'. Here, having a strategic mind-set at every opportunity is important for assessing strategic potential – positive and negative – of the tactical and operational actions. Behavior is combined with process and could also produce more aligned states.

2.1.6 CRE alignment's building blocks

The analysis of fourteen corporate real estate models' graphical representations in Heywood & Arkesteijn (2018) established the most complete map yet of CRE alignment's modelling requirements which to date has been disguised in multiple models. Their meta-study of CRE alignment models used a qualitative hermeneutic method to inductively understand the models' constituent parts. The analysis showed that twelve components have been used to model CRE alignment which are categorized into four Building Blocks: Understanding corporate strategy; Understanding real estate performance; Making real estate strategy; and Implementing real estate strategy as is shown in [Figure 2.5](#) (Heywood & Arkesteijn, 2018). While all representations contained the four Building Blocks, few models contained all twelve components, though all contained at least seven. Completeness of representation should not be inferred as equating to effectiveness as an alignment process. Underneath each building block and its components is briefly discussed followed by the various feedback mechanisms which were also evident between the components. Lastly the graphical representations of the models are discussed.

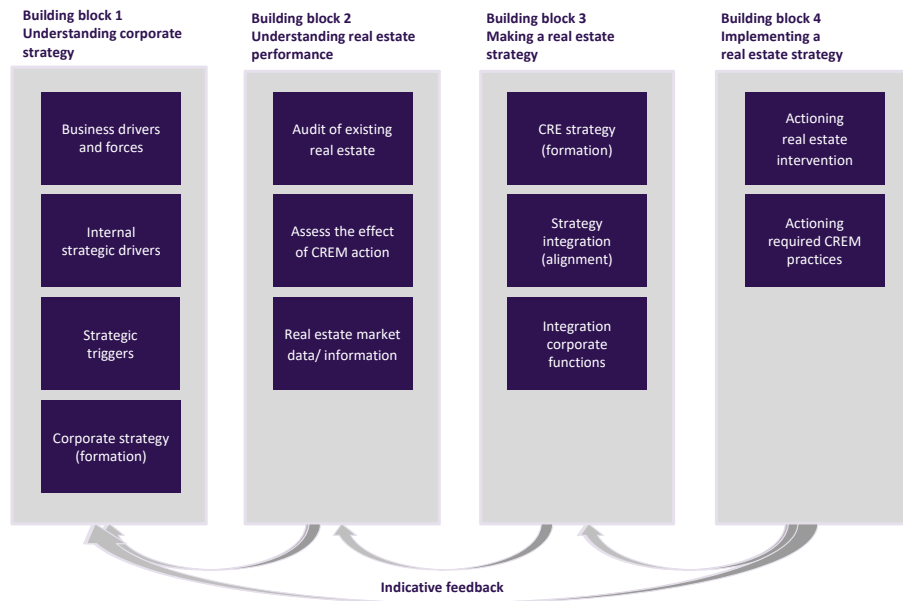

FIG. 2.5 CRE alignment building blocks and components Note from Heywood & Arkesteijn, 2017, p. 17, NB. This categorization differs slightly from previous publication in Heywood (2011) as subsequent work has tested and refined the original work resulting in different components and names.

Building Block 1. This Building Block is about understanding the corporate strategy, the factors that give rise to strategies, and the strategizing itself. This means that alignment is more than just knowing ‘What is the business and its strategy (ies)?’ or the business ‘needs’, it is also understanding its strategic basis, the dynamics of that basis and the organizational strategy creating process. This understanding is very important in CREM where the real estate objects’ service lives exceed business cycles.

- *External business drivers and forces.* This component identifies the organization’s external impacts that require strategic responses. They are the underlying external operants that affect the business creating something like a ‘force-field’ in which the business operates. We distinguish between external and internal drivers because these are the two perspectives organizations must resolve in making strategy (Heywood & Kenley, 2008).
- *Internal strategic drivers and forces.* This component is considered in two ways. One, relates to those generated through internal support functions – the CIR-IRIS concept (Dunn et al., 2004; Materna & Parker, 1998). A second way of understanding

internal drivers and forces is the so-called 'soft' or 'social' management dimensions, for example, leadership styles and methods, entrepreneurship, culture, and organizational structures.

- *Strategic triggers.* This component is for understanding what it is in the organization's operating context that creates organizational change. This indicates the underlying frequency with which strategic triggers emerge. Specific change in the drivers and forces – changes in magnitude and timing – are clear strategic triggers.
- *Corporate strategy (formation).* This component includes the identification of the corporate strategies and how the organization forms strategy because what is required is more than 'just' knowing what the strategy is.

Building Block 2. This Building Block's three components are about understanding the real estate objects' performance in relation to alignment. They refer to the state of the portfolio and its individual real estate objects, knowing how CREM actions change alignment states, and grounding CRE alignment decisions within real estate markets. Performance and its measurement have long featured in CREM. Performance's evaluative basis is unspecified here but various ways are suggested for how to do this for the various roles CRE performs in organizations – as a factor of production, a corporate (balance sheet) asset, a corporate investment, a real estate commodity, and in contributing to the public realm (Heywood & Kenley, 2013).

- *Audit of existing real estate.* This component assesses the current state of portfolios and individual properties prior to alignment actions, thereby benchmarking future assessments.
- *Assess the effect of CREM actions.* This component is for assessments, other than an original audit, of the effect of possible CREM alignment actions. Usually this is post-alignment but pre-knowing the effects of CREM actions helps decide the CRE strategies in Building Block 3, and Building Block 4's interventions to use.
- *Real estate market data/information.* This component captures the information required to evaluate a portfolio and its real estate objects. This data/information provides a foundation for creating CRE strategies that are 'commercially viable'. This means that real estate products are available or potentially available in locations and at prices to satisfy alignment requirements. Where specific real estate objects sit in the real estate market (and aggregated to the whole portfolio) needs to be understood and market information and data provides this.

Building Block 3. These three components form the actual CRE strategy making. They represent the strategy itself and its formation, an act where the corporate and CRE strategies are actually aligned (ahead of Building Block 4's implementation), and relationships with other corporate functions through the CIR-IRIS concept.

- *CRE strategy (formation)*. This component recognizes the models' two related dimensions to CRE strategy – listing or documenting various strategies (the models contain CRE strategies), and ways of creating CRE strategy. Some models list possible CRE strategies. Other models develop ways of creating CRE strategies without necessarily predefining them. Others, suggest where strategies are required.
- *Strategy integration*. This component recognizes that CRE and corporate strategies need bringing to an actual alignment state. Based on dictionary definitions (*Oxford English Dictionary*) either the corporate or the CRE strategies could move.
- *Integration with other corporate functions*. This component recognizes that CRE strategy is rarely enacted alone and often requires other corporate functions, like HR and Finance to achieve desired strategic outcomes. Forms of inter-functional coordination are important for enterprise value (Kaplan & Norton, 2006).

Building Block 4. This Building Block is about making the actual changes to reach alignment in two components. These are the operating real estate and management decisions that are core CREM practice.

- *Actioning the real estate intervention*. This component involves the portfolio changes to individual real estate objects that are necessary to actualize aligned CRE and organizational strategies. Various authors suggest types of decisions, also referred to as applicable types of real estate interventions. From their implications these operating decisions may also be called strategic real estate options but essentially they are transaction-based decisions about 'acquiring, controlling, managing, and disposing of real property interests' (Nourse & Roulac, 1993, p. 486). It is a working assumption that over time, the portfolio's alignment improves from more aligned real estate objects. Business dynamics raises questions as to whether perfect alignment is ever achievable because over time context and requirements change. At best, alignment might be partial in the portfolio, though more complete for any one object.
- *Actioning the required CREM practices*. This component recognizes that CREM practices are also required to reach alignment. These are extensive with at least 162 being identified (Heywood & Kenley, 2008).

Feedback in models

Another important aspect of graphically representing CRE alignment was the models' treatment of feedback. Most models explicitly included some feedback. Various approaches were evident but broadly can be categorized as occurring between components in one Building Block and another:

- (Formulating) CRE strategy (a Building Block 3 component) and the CRE itself (Building Block 4) (Edwards & Ellison, 2003);
- Performance evaluation/management (Building Block 2) and (formulating) CRE strategy (Building Block 3) (Edwards & Ellison, 2003);
- Aligned CRE and core business (Building Blocks 1 and 3) (Then, 2005; Wills, 2008);
- Future requirements and current provision (of CRE) (Building Blocks 2 and 3) (De Jonge et al., 2009; Then, 2005);
- Within corporate strategy processes (Building Block 1) (with CRE embedded in that in some way) (Building Blocks 2 and 4) (Lindholm, Gibler, & Levainen, 2006; Osgood, 2004; Weatherhead, 1997; White, 1999);
- Double-headed arrows within the diagram between the model's elements were often used indicating action and feedback (De Jonge et al., 2009; Englert, 2001; Nourse & Roulac, 1993; Then & Tan, 2013);
- Inferred within management practices as a vehicle for improvement/performance (Scheffer, Singer, & Van Meerwijk, 2006).

Graphical analysis

There are three key approaches evident in graphically representing. The first approach uses simple geometrical structures, for example, triangles and rectangles, as a basis of representation. A second approach is a (often) circular strategic management diagram with the main CRE specific alignment model following that diagram. A third approach provides a structured, linear process. Some of these have relatively few steps. Some linear models are considerably more complicated. These complicated flowcharts while appearing comprehensive could be difficult to implement.

Several approaches were also evident in the models' degree of prescription, that is, how much they prescribed specific methods to follow. One approach was to provide detailed, prescriptive step-by-step processes (in effect, an algorithm to follow). A second approach presented loose-fitting, accommodating 'frameworks'. Framework models offer more strategic and flexible alignment, both theoretically and practically. They are strategic by setting an overall, future-shaping direction with tactical and operational level tools and techniques delivering that direction. Because different organizations will have different strategies, over time and even in the same market, a flexible framework seems more useful as theory in accommodating those differences. That flexibility also means not locking alignment into a rigid plan or process, a loose-fitting model offers that.

2.1.7 Designing an Accommodation Strategy frame (DAS)

As graphical representation a flexible framework seems more useful as theory because different organizations will have different strategies, over time and even in the same market. The DAS frame⁷ (De Jonge et al., 2008, De Jonge et al., 2009; Den Heijer, 2011; Van der Zwart et al., 2009) as developed at the TU Delft is such a flexible framework. They describe DAS as a cyclic and iterative process that moves along two axes, from demand to supply and from current to future and can be started at different points (see [Figure 2.6](#)).

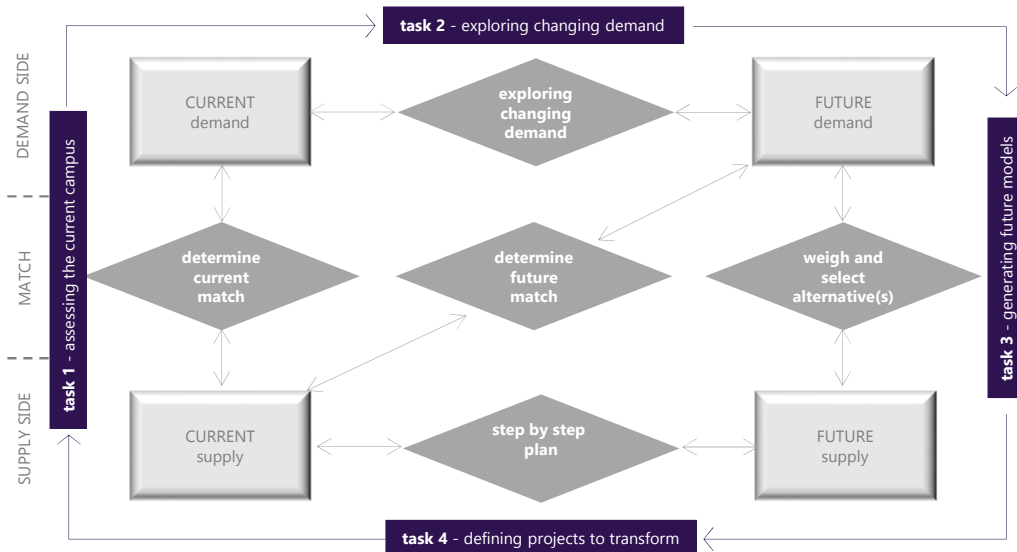

FIG. 2.6 DAS frame (Den Heijer, 2011 adapted from De Jonge et al., 2009)

⁷ In this thesis the DAS Frame will be abbreviated as DAS.

There are four tasks in the framework:

- 1 'What we need' versus 'what we have': determines the mismatch between current demand and current supply;
- 2 'What we need in the future' versus 'what we have now': determines the mismatch between future demand and current supply;
- 3 'Alternatives of what we could have': design, evaluate and select solutions for the mismatch;
- 4 'Step-by-step plan to realize what we want to have in the future' i.e. how to transform the current supply into the selected future supply (De Jonge et al, 2009).

The building blocks from paragraph 2.1 and the DAS frame overlap as follows. Building block 1 understanding the corporate strategy equals current and future demand from task 1 and 2. Building block 3 making a real estate strategy equals task 3 generating future models while Building block 4 implementing a real estate strategy equals task 4 defining projects to transform. Building block 2 understanding real estate performance can be found in multiple places in the DAS frame. First and foremost in determining the match between demand and supply and weigh and select alternatives, but also in task 4 defining projects to transform.

The strength of DAS is its simplicity, as has been noted by (Heywood & Arkesteijn, 2018; Van der Zwart, et al., 2009). It shows clearly and conveniently the necessary steps in designing an accommodation strategy. In appendix A DAS is explained more in detail.

2.2 **Assessment of CRE alignment models from a design and decision making point of view**

The state of the art of CRE alignment was presented in paragraph 2.2 which showed that CRE alignment was complex and pluralistic with four dimensions and four building blocks. Furthermore, CRE decision making is not defined as a specific building block or as a component by Heywood and Arkesteijn (2017). The component closest to decision making is “assess the effect of CREM actions”. However, in this component the focus lies on the assessment of specific actions and

not how to choose the best solution. In this paragraph, the scientific gap of this research is discussed when the alignment models are assessed from a design and decision making point of view. This means that (most of) the models identified in paragraph 2.2. are assessed.

The results of the assessments have been published as part of the following publications:

First assessment

Arkesteijn, M. H. & Binnekamp, R. (2013) 'Real estate portfolio decision making' in Gheorghe, A. V., Macera, M. and Katina, P. F., eds., *Infranomics: sustainability, engineering design and governance*, Dordrecht: Springer, 89-99.

Second assessment

Arkesteijn, M. H., Valks, B., Binnekamp, R., Barendse, P. & De Jonge, H. (2015). Designing a preference-based accommodation strategy: a pilot study at Delft University of Technology. *Journal of Corporate Real Estate*, 17 (2), 98-121.

Third assessment

Arkesteijn, M., Binnekamp, R., & De Jonge, H. (2017). Improving decision making in CRE alignment, by using a preference-based accommodation strategy design approach. *Journal of Corporate Real Estate*, 19 (4), 239-264.

A preliminary assessment of CRE alignment models is made in the book chapter (Arkesteijn and Binnekamp, 2013) and will be discussed in paragraph 2.3.1. Although, there is overlap with the second assessment, it takes a slightly different perspective and because the conclusion from this paper is also used in the second publication it is worthwhile to present here.

The second assessment of CRE alignment models from the paper (Arkesteijn et al., 2015, pp. 99-103) will be discussed in paragraph 2.3.2. It must be noted that when this paper was published, the research in paragraph 2.2. was not yet finished and published but most of the analysis has been done. This assessment will argue that in order to determine whether alignment is reached, it is necessary to look at the alignment form *state* and that at a certain time alternatives need to be 'made/ formulated/ designed in order to enable to determine whether value is added and how much.

The third assessment of CRE alignment models from the paper (Arkesteijn et al., 2017) will be discussed in paragraph 2.3.3. This assessment will look at the models from a decision making point of view specifically and used three decision making perspectives to do so.

The structure of this paragraph is visualized in **Table 2.3**, showing the amount criteria and the amount of models in the different assessment rounds.

TABLE 2.3 Criteria in the three assessments

Assessment	1st	2nd	3rd
# assessment criteria	2 criteria	3 criteria	2 criteria
# models	7	14	14
paragraph	2.2.1	2.2.2	2.2.3

2.2.1 First assessment of CRE alignment models⁸

In the strategic alignment within CREM s well as in public real estate management (PREM) *adding value* and *optimally attuning* are central concepts. In this paragraph the focus is on how preference is measured in certain alignment models and how the stakeholders' interests are integrated, i.e. how a strategy is selected, i.e. how an optimal solution is determined. This is explained using an example from municipal real estate management.

The importance of preference as main concept in this thesis is mentioned in the summary and introduction. However, if before reading the assessment of preference measurement in alignment models, the reader wants more understanding of the concept of preference and correct measurement as used in this thesis the following paragraphs can be read first paragraph 3.1.5, paragraph 3.1.9, paragraph 3.1.10 and paragraph 3.2.

⁸ This paragraph is mostly based on (Arkesteijn & Binnekamp, 2013) but to make it logically readable some captions have been added and sentences have been deleted or altered. The cited text is purple.

Municipalities own 42 million square meter gross floor area size in the Netherlands, which almost equals the size of the Dutch office market (Vastgoedmarkt, 2011). The book value of this portfolio is estimated at 15 to 20 billion euro by Teuben et al. (2007), with an estimated market value of 30 to 37 billion euro. Tazelaar and Schonau (2010, p. 6) indicated that the professionalization of PREM for municipalities in the Netherlands currently is important because of three reasons: (1) the need for more efficient use of municipal real estate; (2) the increasing demand for public accountability; and (3) the quality of municipal services.

Consider the following example of such a selection process: a municipality acquired a substantial number of buildings within its city to serve societal goals. However, some buildings (might) no longer serve societal goals and could be sold or, conversely, buildings that could serve societal goals can be acquired. More than one decision maker decides which intervention to select. Choosing the intervention that meets the different goals best is in essence a multi-criteria group decision making problem. Multiple Criteria Decision Analysis (MCDA) methodologies enable the aggregation of the performance rating of alternatives on different criteria into an overall performance rating. Alternatives are rated on preference on each criterion. Given that criteria are properties by which to measure the portfolio's performance on a goal we can expect that MCDA approaches help to find the combination of interventions that aligns the portfolio to the organizational objectives.

For these MCDA models within corporate and public real estate management the work of Barzilai (2007) and Binnekamp (2010) is relevant because Barzilai (2007, p. 2) focuses on measuring preference (synonymous to value and utility) and found errors at the foundations of utility theory⁹. Most CREM models use an algorithm-based approach according to Heywood (2011, p. 6) which he defines as a series of defined steps, meaning that although indicated by the terminology mathematical operations are not necessarily used. In order to determine whether these models are based on mathematically sound foundations CREM and PREM models are evaluated. Firstly, it is determined whether mathematical operations are used and secondly, for the methods using mathematical operations, if strong, proper or weak scales have been used.

⁹ The concept of correct measurement is based on the work of Barzilai (2010) and is explained in-depth in chapter 3.

TABLE 2.4 Assessment of CREM and PREM models.

Domain	Authors	Use of mathematical operations	Scales used
CREM	Nourse and Roulac (1993)	Yes	Not indicated
CREM	Edwards and Ellison (2003)	No	N.A.
CREM	Osgood (2004)	No	N.A.
CREM	Scheffer et al. (2006)	Yes	Weak
PREM	Brackertz and Kenley (2002)	Yes	Weak
PREM	Wilson et al. (2004)	No	N.A.
PREM	Van der Schaaf (2002)	Yes	Weak

As can be concluded from **Table 2.4**¹⁰ in three of the four models that *use* mathematical operations weak scales were used, which means that the conditions are *not* satisfied in order for the operations of addition and multiplication to be applicable to scale values. For the three models that do *not use* mathematical operations it can be deferred from the models or case descriptions that mathematical operations are performed when evaluating the performance and/or selecting a strategy. However, in their texts it is not explicitly shown how the preferences were measured and how the overall performance rating was determined. Brackertz and Kenley (2002, p. 62) for instance use employee satisfaction and a customer satisfaction ratio as performance measures. Nourse and Roulac (1993) indicate that they use linear programming but do not specify how. Binnekamp (2010, pp. 2, 59-61) also found a major problem relating to the use of linear programming for solving group decision making problems; the end result is a single objective function that aims to reflect the goals of all decision makers. Edwards and Ellison (2004, pp. 27-28) indicate that their framework is a heuristic tool and as such should be used to order information and to facilitate understanding of property problems. The selection and implementation of strategies are brought together in general in the framework and addressed through the case studies. In some case studies they refer to ‘overall performance rating’.

We conclude that, as yet, no methodology for designing a portfolio exists which incorporates proper preference measurement.

¹⁰ In this preliminary assessment CREM and PREM models were used; only four authors overlap with the other assessments that focus on CREM models.

2.2.2 Second assessment of CRE alignment models¹¹

In order to be able to determine whether or not alignment is reached I will argue that three requirements need to be satisfied. First of all, that the CRE alignment model¹² needs to be a design method and not only an evaluation method. Second of all, that the model needs to enable the measurement of quantitative and qualitative requirements. Lastly, that the performance on criteria need to be aggregated into an overall performance rating in order to be able to determine whether or not maximum or optimum value is added by CRE to the organization.

Requirement 1: CRE alignment models need to be a design method

Arkesteijn and Heywood (2013) group CRE alignment components into four building blocks: (1) understanding corporate strategy, (2) understanding real estate performance, (3) making a real estate strategy and (4) implementing a real estate strategy. Alignment as a *state* becomes most evident in the building block understanding real estate performance. Arkesteijn and Heywood (2013) position three components in this block: (a) audit of existing real estate, (b) real estate data/information and (c) assess the effect of CREM actions. In an audit of existing real estate one can determine the *current state of alignment* of the CRE portfolio. However, only after 'making and implementing a real estate strategy' one is able to determine whether the CRE portfolio resulting from this new CRE strategy has been optimally attuned. This is done in the component assess the effect of CREM actions. Therefore, the authors argue that a CRE alignment model cannot only be an evaluation method but also that it needs to be a design method.

In a design method one or more alternative real estate strategies are made. Examples found in literature are Nourse & Roulac (1993) and Roulac (2001), who identify eight real estate strategies resulting in specific operating decisions. The accommodation strategy is a combination of one (or more) of these strategies (together). In a design method, the objective is to design the best possible alternative. In an evaluation method the current real estate strategy, with its current real estate portfolio, is evaluated. The objective of an evaluation method is to assess the current situation. The combination of making and implementing a real estate strategy consists of multiple CREM actions resulting in alternative

¹¹ The text is mostly based on Arkesteijn et al. (2015) but to make it logically readable in this paragraph some captions have been added and sentences have been deleted or altered. The cited text is purple.

¹² In the paper the reference is made to an alignment method, while in a later stage the reference is made to a model. Both words can be used interchangeably in this paragraph.

real estate portfolios. The word strategy is used both as process and content: as Chaffee (1985, p. 89) states, “the study of strategy includes both the actions taken, or the content of strategy, and the processes by which actions are decided and implemented”. Identifying and analyzing alternatives, selecting the best alternative with a view to future developments and executing the strategy are considered an integral part of strategic management, according to Snyder & Glueck (1980, p. 73) and Mintzberg (1994, p. 9). When addressing ‘making a real estate strategy’ the alignment models refer both to strategy as a content and strategy as a process. When studying the alignment state, the authors will refer to the alignment reached by the strategy content.

In CREM, research into alignment is focused more on strategy as a process than on strategy as a content. De Jonge et al. (2009) studied the selection process in six models and concluded that most models briefly touch upon the selection process and only indicate the type of selection. Osgood (2004), for instance, uses cause and effect relationships and states that “the author interprets the concepts and develops ideas that describe ways that real estate can align with and reinforce the strategy” (Osgood, 2004, p. 75). O’Mara (1999) follows Porter (in O’Mara, 1999) and positions three generic strategies between the dimensions ‘strategic uncertainty’ and ‘view on action’. She also states that “Although learning about the struggles other companies have gone through can help you see patterns in your company’s behavior, there is not one set of rules to follow in developing a strategy that will work best for your company (O’Mara, 1999, p. 189)”. Roulac (2001) uses conceptual linear programming: he gives tables in which he addresses eight alternative accommodation strategies in terms of alternative choices that enterprises are confronted with concerning the places in which they operate. The eight alternative real estate strategies can be related to the seven contributions of the superior corporate strategy for competitive advantages.

The result is that alignment models can be difficult to employ when looking at the selection of an accommodation strategy, as is concluded by Arkesteijn and Binnekamp (2013). They find that the models suggest selecting the best alternative but did not have a well-defined procedure for doing so. In their view a well-defined procedure would allow a real estate manager to use the model without needing extra information or help from the author(s). This procedure needs to be operational and their view is that if alignment is perceived as a state, it should be measured. This leads to the second requirement.

Requirement 2: CRE alignment models need to measure quantitative and qualitative requirements

Measuring the alignment state often includes qualitative (subjective) and quantitative (objective) data. According to Gerritse (1999, p. 9), the meaning that people assign to the term quality often leads to confusion. ISO (2005; chapter 3.1.1) has defined quality as “Degree to which a set of inherent characteristics fulfils requirements”. In this definition, quality reflects the judgment of one or more persons with regard to a characteristic or set of characteristics. This judgment is bound by time, place and culture. Furthermore, in the summation of characteristics relating to quality, another problem is found: how to measure the quality of these characteristics. In CREM the same issues are relevant, the CRE alignment models also indicate the importance of both quantitative and qualitative criteria, indicators or variables. However, in CREM instead of referring to quality, mostly the term value or adding value is used. The authors’ position of alignment as a state requires a value measurement which should be able to include both quantitative (e.g. carbon emissions) and qualitative (e.g. architectural value) characteristics.

On measuring the quality of an object or characteristics of an object, Barzilai (2010, p. 71) states the following: “value (or utility, or preference) is not a physical property of the objects being valued, that is, value is a subjective (or psychological, or personal) property. Therefore, the definition of value requires specifying both what is being valued and whose values are being measured”. Put in the terms used in the definition given by International Organization for Standardization (ISO): although most characteristic of an object can be objectively measured, the degree to which it fulfils the requirements remains subjective. The requirement needs to be set by someone. Value, utility or preference can therefore not be defined objectively.

Requirement 3: CRE alignment models need to aggregate performance on criteria into an overall performance rating

When selecting an intervention or a series of interventions in CREM, there often is an existent real estate portfolio with an existent value: in other words, the portfolio is already aligned to a certain degree. In the process of selection, the question is: which interventions result in the most *added value* to the real estate portfolio? In CREM strategies are usually made to provide the answer to this question. When selecting a strategy in order to achieve the state of alignment, one needs to determine (1) the value of the current real estate portfolio and (2) the value added by the different strategies. The strategy that maximizes the added value is selected.

Assessment of the requirements

In summary, the authors argue that the following aspects can be used to determine whether alignment as a certain state is reached:

- Is the method an evaluation or a design method?
- Are scales used to determine whether quantitative and qualitative requirements are met and are they established directly by decision makers?
- Is the performance on criteria aggregated into an overall performance rating?

In **Table 2.5** the existing CRE alignment models are reviewed based on these three aspects. This is done to determine if an existing method is able to determine alignment as a state as defined by the authors.

TABLE 2.5 Second assessment of CRE alignment models

Authors	Design or evaluation method	Scales used by decision makers	Aggregation of overall performance
Nourse &Roulac (1993)	design	implied	no
Weatherhead (1997)	design	no	financial
White (1998)	design	implied	no
O'Mara (1999)	design	no	no
Englert (2001)	design	implied	financial
Edwards and Ellison (2003)	design	implied	no
Osgood Jr. (2004)	design	implied	financial
Wills (2005)	design	no	no
Haynes (2008)	design	no	no
De Jonge et al. (2009b)	design	no	no
Then and Tan (2010)	design	implied	no
Den Heijer (2011)	design	yes	no
Scheffer et al. (2006)	evaluation	yes	yes
Appel-Meulenbroek et al. (2010)	evaluation	n.a.	n.a.

The evaluation methods assess the current alignment between the organization and CRE (strategy). Scheffer et al. (2006), on the other hand, predefine added values based on which they assess the current CRE strategy. In the model scales are used to measure the alignment and the state of alignment is calculated in an overall measure, defined as 'the percentage use of the added value contributing to the specific driving forces' while they also indicate 'the percentage use of other added values'. The other two evaluation models do not use an overall measure of alignment. Appel-Meulenbroek et al. (2010) use scales to validate the alignment table of Nourse and Roulac (1993) but do not measure the state of the CRE portfolio and is therefore not applicable in the comparison. The evaluation models use experts in real estate or facility management as decision makers, however, none of the models involve other decision makers to measure whether the CRE strategy content fulfils their specific requirements.

Of the CRE alignment models that are a design method, five do not use scales to measure value, while six imply to use scales. However, they do not show how and by whom this is done. Only the model of Den Heijer (2011), which follows De Jonge et al. (2009), uses scales to measure value. O'Mara (1999) also uses scales but to measure the context of the organization (e.g. strategic environment uncertainty) and not the values that the decision makers want to achieve with their CRE strategy. Then and Tan (2010) for instance indicate how the alignment can be assessed with their model and indicate which alignment criteria should be taken into account. These criteria are quantitative as well as qualitative and therefore imply scales will be used. In the conceptual model it is not clear if or which scales are used to measure the criteria. In their model they indicate that existing and new facilities can be assessed, however the design of the new real estate portfolio is not discussed.

Only three models have an overall performance measure. Englert (2001) uses EVA and RONA as overall financial performance measure while Osgood Jr. (2004) also mentions EVA and shareholder value. Weatherhead (1997) uses the highest net present value. But by doing so, they do not take into account other attributes than financials in their CRE strategy design, at least not in their overall measure. None of the models have a measurement made by the decision makers to establish their own criteria and their desired performance.

From **Table 2.5** we conclude that currently no method exists that 1) allows designing a portfolio, 2) makes use of scales for direct measurement of added value/preference, and 3) allows the aggregation of individual ratings into an overall performance rating.

2.2.3 Third assessment of CRE alignment models¹³

In this paragraph, the existing CRE alignment models are studied from a decision making perspective Arkesteijn et al. (2017) in line with the previous study of Arkesteijn et al. (2015) (see paragraph 2.3.2) to determine if in the existing models it is clear when, by whom and how is the (optimal) alternative chosen?

Requirement 1: is CRE decision making a black box or a transparent glass box?

The first observation is that CRE decision making is not defined as a specific building block or as a component by Heywood and Arkesteijn (2017). The component closest to decision making is 'assess the effect of CREM actions'. However, in this component the focus lies on the assessment of specific actions and not how to choose the best solution. Therefore, a closer look is given to the underlying CRE alignment models.

In the CRE alignment models, decision making receives little attention. In the graphical representations of these models, nine models do not have a specific graphical *box* representing decision making (Weatherhead, 1997; O'Mara, 1999; Englert, 2001; Osgood, 2004; Then, 2005; Wills, 2005; Scheffer et al., 2006; Haynes, 2008; Then and Tan, 2010), while five models have a specific *box* that at a certain point in the process indicates that one or more decisions need to be made (Nourse & Roulac, 1993; Lindholm & Levainen, 2006) refer to operating decisions, White (1998) to identify, evaluate options and agree strategic real estate plan, Edwards and Ellison (2003) selection of strategies, Den Heijer (2011) based on De Jonge et al. (2009), weigh and select alternative(s). However, this *box* often is a *black box* in which it remains unclear exactly how and by whom the best solution is chosen. Only some authors indicate which technique is used to decide, multi-criteria decision making or conceptual linear programming (Nourse & Roulac, 1993). In conclusion, in most models, decision making is only briefly touched upon and not elaborated upon.

¹³ The text is mostly based on Arkesteijn et al. (2017) but to make it logically readable in this paragraph some captions have been added and sentences have been deleted or altered. This cited text is purple.

Requirement 2: do CRE alignment models have a substantive approach to decision making

To further clarify this statement, CRE alignment models are classified into three types of decision making as distinguished by Kickert (in De Leeuw, 2002, p. 256), which De Leeuw refers to as three types of rationality. The classification scheme is as follows: the *first type* is *substantive rationality*, which is about the choice of an (optimal satisfactory) alternative. Whereby, De Leeuw states that there are different subtypes but all of them are about the choice – with or without handicaps – of an alternative. This type is characterized by the fact that there is only one decision maker and the aspect of time is mostly disregarded. In the *second type*, the *procedural rationality*, the focus is not on the content of the decision but on the way that the decision is made. decision making processes are seen as time ordered steps leading to a decision. In this type, a meta level is present, since it is about decision making. The *third type* is *structural rationality* – which is, like the former, a kind of meta level. It addresses the question of what is an appropriate (the best, satisfactory) organization for decision making. The decision problem is the order in which the various participants need to be dealt with by whom in the decision making process. The decision is seen as the result of a decision making process in time in which more decision makers participate.

Most models take a procedural rationality approach to decision making. This is also concluded by Heywood in his 2011 paper in which he refers to them as an ‘algorithmic’ approach as well as by Heywood and Arkesteijn (2017) where they refer a ‘process’ as one of the four CRE alignment forms. The procedural rationality models of Weatherhead (1997), White (1998), Edwards and Ellison (2003), Osgood (2004), Wills (2005), Then (2005), Haynes (2008), De Jonge et al. (2009), Then and Tan (2010) and Then et al. (2014) indicate what needs to be taken into account and give a certain order to reach alignment.

The structural approach is only present in Englert’s (2001) CRE alignment model. His message is to have a horizontal dimension to strategic planning based on Porter’s (1985) competitive advantage through a managed process. This process consists of communication networks, which are a trick, as Englert (2001, p. 9) explains, to link and integrate strategies to engineer collaborative results that tie to organizational objectives.

There are no models that have a substantive rationality approach in which they offer a well-defined procedure how to select the best option. A substantive approach is only partially present in four existing CRE alignment models: O’Mara (1999), Nourse and Roulac (1993), Lindholm and Levainen (2006) and Den Heijer (2011). O’Mara (1999), for instance, has three strategies organizations can choose from:

standardization, incrementalism and value based. She indicates (in her Figure II.1) that the choice for a strategy varies according to strategic uncertainty (ranging from low to high uncertainty) and also on the theoretical bases of decision making criteria (ranging from rational instrumental to valuational symbolic). However, next to this, she also has a 'basic model of a structuring process' which has a procedural rationality approach. Nourse and Roulac (1993) and Lindholm and Levainen (2006) explain how alternatives can be generated by combining several real estate strategies. Their list of strategies is: increase value of assets, promote marketing and sale, increase innovation, increase employee satisfaction, increase productivity, increase flexibility, reduce costs which they, amongst others, based on Nourse and Roulac (1993). Den Heijer (2011) has a similar but longer list based on De Jonge (1994) and they call this 'ways to add value'. Den Heijer's research is focused on universities and presents models (traditional, network or virtual university or the university college) that organizations can choose from. Den Heijer provides information to support real estate decisions; the management of the organization itself needs to make the decision. In general, one can say that these CRE alignment models function like so-called reference models. De Leeuw (2002, p. 301) indicates that stakeholders can use explicit reference models (also called performance measurement systems), when defining their problem situation. A very well-known example is the balance scorecard (Kaplan & Norton, 2006). The models with a partial substantive rationality approach help the stakeholders to translate objectives into concrete variables (also called performance indicators).

If a closer look is given to this substantive approach, it is important to realize that Englert (2001), for instance, indicated that one of the potential barriers to alignment is that 'higher level strategies may not be clear or may be difficult to implement'. Having a clear vision and well-defined metrics to measure progress is therefore essential according to him. He even stresses that it is the single most important initiative to achieve alignment to establish corporate metrics and targets (Englert, 2001, pp. 8; 15). Of the four partially substantive CRE alignment models, one does not have well-defined metrics O'Mara (1999), and while Nourse and Roulac (1993), Roulac (2001) and Lindholm and Levainen (2006) translate the strategies into operating decisions, the decisions are not at the level of well-defined metrics. Den Heijer (2011) does have well-defined metrics. Other CRE alignment models (from the procedural decision making approach) confirm the importance of metrics implicitly or explicitly, like White (1998), Then (2005), Haynes (2008), De Jonge (2008, 2009), Then and Tan (2010) and Then et al. (2014). It is clear that all CRE alignment models aim to add value to the organization and to use well-defined metrics for this; however, it is not clear how the best option can be chosen.

2.2.4 Summary of assessment criteria

In this paragraph, CRE alignment models have been assessed in three rounds on different criteria. In [Table 2.6](#)¹⁴ is given as well as the main conclusions. In CRE alignment decision making is often a *black box*. The maximum that these models deliver is to indicate which technique can be used. Currently no method exists that 1) allows designing a portfolio, 2) makes use of scales for direct measurement by the stakeholders of added value / preference, and 3) allows the aggregation of individual ratings into an overall performance rating.

TABLE 2.6 Summary of assessment criteria

1st	Assessment of seven CRE alignment models	conclusion
1	Are mathematical operations are used?	Some models use or imply to use mathematical operations
2	For the methods using mathematical operations, have strong, proper or weak scales been used?	No methodology for designing a portfolio exists which incorporates strong scales for preference measurement.
2nd	Assessment of fourteen CRE alignment models	conclusion
1	Is the method an evaluation or a design method?	Most models are design methods
2	Are scales used to determine whether quantitative and qualitative requirements are met and are they established directly by decision makers?	Most models want this, i.e. involve stakeholders and indicate that different criteria need to be used, both qualitative and quantitative. In some models it is indicated that scales need to be used to measure the qualitative criteria but it is not clear if they are directly set by the stakeholder. The models that want this do not have an overall performance rating
3	Is the performance on criteria aggregated into an overall performance rating?	The models that use an overall performance rating use a financial measure, and do not satisfy criteria 2 at the same time.
3rd	Assessment of fourteen CRE alignment models	conclusion
1	<i>Black box</i> or transparent <i>glass box</i> for decision making	Decision making is a <i>black box</i>
2	Do the models have a substantive approach in which it is clear how the (best) alternative is chosen	It is clear that all CRE alignment models aim to add value to the organization and to use well-defined metrics for this; it is however not clear how the best option can be chosen.

¹⁴ In the conclusion of this chapter the criteria are given a label to streamline them and draw a conclusion. In appendix B the link between the assessment criteria and the labels is given.

2.3 Conclusion

One of the long-standing issues in the field of Corporate Real Estate Management is the alignment of an organization's real estate to its corporate strategy. CRE alignment is even defined by some as the *raison d'être* of CREM, as the range of activities undertaken to attune corporate real estate optimally to corporate performance. From an apparently disordered theory of the many models, the analysis by Heywood and Arkesteijn (2017) shows CRE alignment to be complex and pluralistic, being several things simultaneously and they indicate it is not possible to show CRE alignment as a singular, definitive 'thing'. Though complex, their analysis represents a significant conceptual improvement in the field. This understanding point towards how good alignment models should treat the four dimensions they have found.

CRE alignment should occur between multiple cognitive-objects, with three evident on the business side (business strategies and their context, business performance and business needs) and three on the CRE side (CRE strategies, CRE and CRE management). There is a multi-valent relationship between these objects and many words have been used to capture different values. CRE alignment is also multi-directional, that is, iteratively vertically between the organizational and functional levels, horizontally across the business units and the corporate infrastructure functions, and between demand and supply. CRE alignment consists of multiple forms of two distinct types – process-based and behavior-based. Either mode of existence is about changing alignment states for the better. From their subsequent publication (Heywood & Arkesteijn 2018), arrived inductively at four Building Blocks, twelve components of CRE alignment modelling and feedback between the components and Building Blocks. As graphical representation a flexible framework seems more useful as theory because different organizations will have different strategies, over time and even in the same market.

Even though extensive research into these existing CRE alignment models has provided us with valuable insights into the building blocks, components, relationships and variables that are needed in the alignment process, these models still fall short in two ways. Most models pay little to no attention to the design and selection of a new portfolio that adds the most value to the organization. This is the focus of the research as can be seen in [Figure 2.7](#).

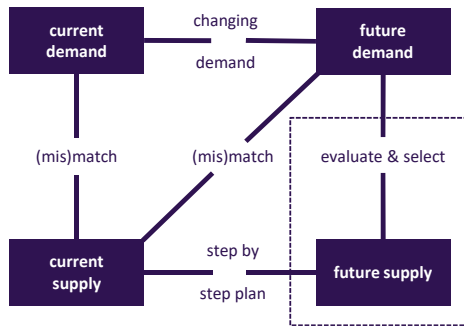

FIG. 2.7 Focus of this research visualized in DAS Note adapted from De Jonge et al., 2009; Den Heijer, 2011; Van der Zwart et al., 2009

In three assessments, it has been logically argued what is needed in a CRE alignment model. Over the years, the formulation of the requirements and the focus in them has shifted. A comprehensive overview has evolved into an integrated list of eight requirements. Each requirement has been given a short label to be recognizable during the thesis. Next to that, the requirements were divided over three groups following DAS: formulating demand, designing alternatives (supply) and selecting an alternative.

The following logic and assessment is given.

Formulating demand

- an alignment model needs to be able to involve all relevant stakeholders and specify all types of requirements, i.e. values, (quantitative and qualitative), because research has shown that they are important in a CRE alignment process. This requirement is labelled *integral*. From the assessment it is concluded that most models want to be integral, however, these models are not indisputable or correct at the same time, because they do not use an overall performance measure or correct measurement;
- an alignment model needs to be able to use well-defined decision variables to measure their real estate vision. A well-defined decision variable is also referred to as a concrete, tangible or operational variable. A real estate vision is similar to a strategy or objectives/goal. This is important because to it makes clear what the goals exactly mean. This requirement is labelled *tangible*. From the assessment it is concluded that most models have or encourage the use of well-defined tangible decision variables.

- an alignment model needs to be able to ensure that each decision variable is established by a specific stakeholders, because as Barzilai (2010) explained “value (or utility, or preference) is not a physical property of the objects being valued, that is, value is a subjective (or psychological, or personal) property. Therefore, the definition of value requires specifying both what is being valued and whose values are being measured”. This requirement is labelled *personal*. From the assessment it is concluded that most models involve stakeholders in the CRE alignment process, but none of them makes an explicit and continuous link between a stakeholder and their decision variables. Some models put emphasis on the CREM manager instead of the stakeholders.

Designing alternatives

- an alignment model needs to be able to make/formulate/design alternative real estate portfolios, because the added value of a CRE portfolio cannot be calculated if the value of the current and future portfolio is not known. Therefore, a future portfolio need to be made/formulated/ designed. This requirement is labelled *design*. From the assessment it is concluded that most models are design methods: they state that alternatives need to be made or offer a choice of preset strategies, but often this stays at the level of visions/strategies and is not translated to the physical level (portfolio);
- an alignment model needs to have a feedback loop (between demand and supply) for stakeholders to understand the effects of their choices. This requirement is labelled *iterative*. From the assessment it is concluded that most models have a feedback loop.

Selecting an alternative

- an alignment model needs to be able to aggregate the performance of an alternative on individual decision variables into an overall performance measure to be able to choose the best alternative. This requirement is labelled *indisputable*. From the assessment it is concluded that the models that use an overall performance measure, i.e. a single-valued objective, use a financial measure, however these models are not integral;
- an alignment model needs to deliver an indisputable result but is preferably also able to choose an optimal alternative because it might be that apart from the best alternative there a more optimum alternative possible. This requirement is labelled *optimal*. From the assessment it is concluded that most models strive for a multi-valent relationship between CRE and the organization, however, none of the models can determine which alternative is the optimum.
- an alignment model needs to ensure that if measurement scales are used to measure non-physical properties strong scales are used to enable the application of addition and multiplication to arrive at an overall performance score. This requirement is labelled *correct*. From the assessment it is concluded that none of the models uses correct measurement.

Scientific gap

When formulating the demand, most CRE alignment models take a similar approach. The authors indicate that all relevant stakeholders need to be involved to formulate an integral set of well-defined tangible (qualitative and quantitative) criteria to measure their real estate strategy/vision/objectives. In the models, stakeholders are involved, however, it is not clear whether they set their own criteria and are as individual or group personally involved throughout the process. Although, most CRE alignment formulate alternative CRE strategies at visionary level, which are mostly translated to well-defined tangible criteria. Often, however, they are not translated to the corporate real estate itself, i.e. to the portfolio and building level. At least, it remains unclear how new alternative real estate portfolios are made/formulated/ designed. Most problems in CRE alignment occur when selecting an alternative; none of the models have an overall performance measure that incorporates both quantitative and qualitative criteria, and use correct measurement. Therefore, they do not produce an indisputable result.

3 Basic concepts and definitions of the PAS design and decision system

chapter 2	CRE alignment state of the art and scientific gap
-----------	---

**Preference-based Accommodation Strategy (PAS)
design and decision approach**

Developing PAS		Testing PAS			Evaluating PAS
chapter 3	chapter 4	chapter 5	chapter 6	chapter 7	chapter 8
fifteen basic concepts and definitions from decision, design and management theory		steps			steps
			stakeholders & activities		stakeholders & activities
				model	model

chapter 9	Reflecting upon PAS
-----------	---------------------

chapter 10	Conclusions and recommendations
------------	---------------------------------

3 Basic concepts and definitions of the PAS design and decision system

In this chapter, using basic concepts and definitions from management science, decision theory and design methodology, I shall outline the methodological aspects, characteristics and features of the Preference-based Accommodation Strategy (PAS) design and decision system, which I developed for the formation of a corporate accommodation strategy.

This outline serves first and foremost as a simple way of representing and modeling the PAS design decision system. It also enables the methodological characteristics of PAS design and decision making to be set out in a way that allows analysis and evaluation of the suitability of the applications of this system in real life corporate accommodation strategy processes. Finally, it should be possible to incorporate past experience into the framework, and to generalize and summarize it in order to benefit the further development of the PAS design decision system. The PAS design decision system will be referred to as PAS.

In chapter 2 the existing alignment models were assessed on eight different assessment criteria and it has become clear that decision making receives very little attention in the models. The two main problems were that (1) it remained unclear how alternative CRE strategies are made on portfolio and building level and (2) most problems occur when selecting an alternative; none of the models has an overall performance measure that incorporates both quantitative and qualitative criteria, and uses correct measurement. Although in paragraph 2.2 all assessment criteria have been introduced, some of the concepts will be explained in this chapter. In chapter 2.3 the models have been assessed on their use of correct measurement for instance. In paragraph 3.2 it will be explained what correct measurement is and why it is important.

The chapter is structured as follows:

- Fifteen basic concepts underlying the PAS design system are explained in paragraph 3.1;
- Preference measurement as core concept is explained in more detail in paragraph 3.2;
- Preference-Based Design as other core concept is explained in more detail in paragraph 3.3;
- A comparison of the foundations in different scientific field is given in paragraph 3.4;
- The chapter ends with a conclusion and comparison in paragraph 3.5.

3.1 Basic concepts and definitions

Each of the fifteen basic concepts is presented in a subparagraph. The fifteen basic concepts and definitions are:

- 1 Three types of decision making rationality;
- 2 Goal-oriented human system;
- 3 Concept of the overall performance measure;
- 4 Definitions of problems, goals and value;
- 5 Multiple criteria;
- 6 Specification and modeling of design problems;
- 7 Multi actor design-decision-management system;
- 8 Prescriptive mathematical decision system;
- 9 Preference measurement;
- 10 Overall preference score as performance measure;
- 11 Problem solving system;
- 12 Operational representation of the design (solution) space;
- 13 Preference-Based Design method;
- 14 Design management system;
- 15 Human activity system.

3.1.1 Three types of decision making rationality in PAS

In order to structure the decision making process in PAS three types of rationality are used: *substantive rationality*, *procedural rationality* and *structural rationality*¹⁵ (Kickert in De Leeuw, 2002).

The classification scheme of these types is displayed in [Table 3.1](#). The first type is *substantive rationality* in which it is about the choice of an (optimal/satisfactory) alternative. Here, De Leeuw states that there are different subtypes but all of them are about the choice – with or without handicaps – of an alternative. This type is characterized by the fact that there is only one decision maker, and the aspect of time (order) is mostly disregarded. In the second type, the *procedural rationality*, the focus is not on the content of the decision but on the way that the decision is made. Decision making processes are seen as steps ordered in time leading to a decision. In this type, a meta level is present, since it is about decision making. The third type is *structural rationality* – which is, like the former, a meta level. It addresses the question of what is an appropriate (the best, satisfactory) organization for decision making. The decision problem is the order in which the various participants need to be dealt with by whom in the decision making process. The decision is seen as the result of a decision making process in time in which more decision makers participate. In many decision making processes more decision-makers play a role and this is only taken into account at this level of structural rationality (Kickert, in De Leeuw, 2002, p. 249-258).

TABLE 3.1 Three types of rationality (based on Kickert, in De Leeuw, 2002)

Rationality	Focus i.e. level	Time	Individual / group
First: substantive	Content: choice of an (optimal or satisficing) alternative – with or without handicaps	Not taken into account	Individual decision maker (one-mind system)
Second: procedural	Meta-level: process (decision about how to make the decision)	Taken into account	Individual decision maker (one-mind system)
Third: structural	Meta-level: organization of the decision making (order, participants, aspects)	Taken into account	Groups of decision makers (multi-mind system)

¹⁵ The types of rationality have also been explained in chapter 2 when assessing current alignment models.

In the substantive approach, the basic concept is that a choice is made with handicaps. When referring to handicaps, De Leeuw (2002), indicates that he is aware of the limits of rationality. This means that the original rationality concept of the *homo economicus* is not used, because it has been stretched far by Simon's *bounded rationality*. According to Simon (1997), human decision makers have a bounded rationality: they are not perfectly informed and also have a limited capacity for information processing. They are not looking for maximum but for satisficing alternatives. The search for alternatives stops as soon as an alternative with a satisfactory outcome is found.

Concluding: In PAS all three rationalities are used to open the black box of decision making in CRE alignment. The *substantive rationality* enables the decision maker to choose an alternative. The stakeholders have a bounded rationality, this means that an alternative is selected if it is satisficing for the stakeholders. The *procedural rationality* enables the decision maker to take into account the time perspective when selecting an alternative and the *structural rationality* enables that more than one decision maker is involved. These three rationalities are also used to structure the PAS approach.

Clarification about the concept of rationality

Since the three rationalities are used as basic concept, it is important to note that rationality is not seen as opposite to intuition and creativity (De Leeuw, 2002, p. 266). Intuition, according to him, can be seen as an implicit and inexplicable form of rationality. Intuition is not similar to chance (coincidence) but the decision maker cannot say why he makes a certain decision. Intuition and rational analysis seem to be complementary parts of effective decision making (Sadler- Smith & Sparrow; Simon, in Volker, 2010, p. 50).

3.1.2 PAS as a goal-oriented human system

In PAS, the decision makers who set the goals of the accommodation strategy, are incorporated and therefore the system can be portrayed as a *goal-oriented human system*.

The concept of the goal-oriented system has its roots in Operations Research (OR). OR¹⁶ is a discipline that deals with the application of advanced analytical methods to help make better decisions. These analytical methods are used to understand and structure complex problems, after which they can be applied to improve the performance of a system. The basis of operations research can be found in a formulaic notation used by Ackoff and Sasieni (1968). This notation displays the structure of a generic decision making problem where U represents the goal that one wants to achieve.

$$U = f(X_i, Y_j)$$

U = the utility or value¹⁷ of the system's performance

X_i = the variables that can be controlled: the 'decision' or 'choice' variables

Y_j = the aspects of the situation over which we have no control
(environment of the problem)

Ackoff introduced systems engineering in operations research and is the principal representative of the methodical system approach. A system approach, according to De Leeuw, is a way of thinking in which coherence plays a major role in all kinds of forms. He defines a system as a collection of objects (elements) chosen by the spectator that are related in such a way that no (groups of) elements are isolated from the others. A relation is seen as a (causal) relationship between A and B. Often the relationships are reciprocal, with the effect being the cause and vice versa. The methodical system approach is a specific method for solving practical problems with an emphasis on the interdisciplinary approach (De Leeuw, 2002, pp. 88, 96, 98).

This methodical systems approach is part of the so-called hard system approach, which focuses on systems that deal with goals that are not problematic (i.e. known). The counterpart within the systems approach is the soft systems approach. In these systems, as De Leeuw (2002, p. 92) explains, "the problem situation is ambiguous".

In order to position this basic concept more precisely, the distinction that Franco and Montibeller (2010) make between the *expert* and *facilitated mode* in operational research is used. Franco and Montibeller (2010, p. 489) explain the different modes as follows: "... the expert mode, where the operational researcher uses OR methods and models that permit an 'objective' analysis of the client's problem situation,

¹⁶ Or operational research in British usage; also indicated as management science

¹⁷ Note that in this formula goal, utility and value are used as equivalent.

together with the recommendation of optimal (or quasi-optimal) solutions to alleviate that problem situation.” The facilitated mode is: “An alternative mode of engagement [is] to conduct the whole intervention together with the client: from structuring and defining the nature of the problem situation of interest, to supporting the evaluation of priorities and development of plans for subsequent implementation. In this latter mode, the operational researcher works throughout the intervention not only as an analyst, but also as a facilitator to the client.” Within the facilitated mode Franco and Montibeller (2010, pp. 495-496) distinguish three types: facilitated problem structuring (also known as soft OR methods), facilitated system dynamic and facilitated decision analysis.

The basic assumptions of the expert mode are: (1) problems are real entities (2) the analysis should be ‘objective’, (3) clients want optimal solutions and (4) implementation of scientifically-based analysis is straightforward. The basic assumptions of the facilitated OR approach: (1) problems are socially constructed entities, (2) subjectivity is unavoidable, (3) clients want ‘satisficing’ solutions and (4) participation increases commitment for implementation. The basic assumptions of the facilitated mode roughly overlap with the soft systems approach, although the facilitated mode also is used in the hard systems approach i.e. decision analysis (Franco and Montibeller, 2010, p. 491).

Concluding: PAS is based on the hard and soft goal-oriented systems approach with primarily the facilitated operations research mode as foundation. The soft systems approach enables the decision makers to set goals and achieve a satisficing result, i.e. design alternative. The hard systems approach enables decision makers to choose an optimum alternative.

A goal-oriented human system is a system which seeks to achieve a certain goal or goals, and consists of some decision makers. As Van Loon, Barendse & Duerink (2012) explain “such a system contains decision makers distinguishes it from empirical systems (systems in which processes are autonomous, natural and spontaneous). In the literature, a model of a goal-oriented system is often referred to as a normative (prescriptive, operational) model, and a model of an empirical system is a descriptive (analytical, theoretical) model” (Van Loon, 1998).

3.1.3 The concept of the overall performance measure in PAS

PAS has built in one *overall performance measuring* procedure for all participating decision makers together including all decision makers.

In the field of CRE Alignment two decision-theoretical approaches are often used: the shareholder approach and the stakeholder approach. In the shareholder approach social welfare is maximized when all firms in an economy attempt to maximize their own total firm value. He explains that *firm value* is simply the long-term market value of this expected stream of benefits. This approach has its roots in economics and finance. The stakeholder approach has its roots in sociology amongst others in organizational behavior and strategic management. The shareholder approach receives criticism among others from Robert Kaplan and David Norton, the originators of the balance scorecard, which is the managerial equivalent of stakeholder theory, that purely financial measures of performance are not sufficient to yield effective management decisions (Jensen, 2010, p. 39).

Jensen's (2010) states that these two approaches are often seen as opposites, but he argues that they are different in nature and complementary. In fact, Jensen (2010, p. 33) states "... whether firms should maximize value or not, we must separate two distinct issues;

- 1 Should the firm [organization] have a single-valued objective?;
- 2 And, if so, should that objective be value maximization or something else ... ?"

In the shareholder approach, value maximization is the *scorecard* for the organization but it says nothing about how to create a superior vision or strategy. Nor does it tell employees or managers how to find or establish new initiatives or ventures that create value. The stakeholder approach on the other hand, like Kaplan-Norton's Balanced Scorecard, is a tool to help managers understand what creates this value. The system therefore is best described not as a scorecard but as a *dashboard* or instrument panel (Jensen, 2010, p. 40).

Coming back to the first issue, Jensen (2010) criticizes the stakeholder approach and states that managers in an organization need to define what is better and what is worse which forms the basis of making decisions. Therefore, Jensen (2010) argues that a single-valued objective function is a needed for purposeful behavior by any organization, which the stakeholder approach lacks. The stakeholder approach (such as the Balanced scorecard) lacks such function. Regarding the second issue, Jensen chooses the firm value as measure but explicitly states that the logic does not specify what the objective function should be.

Concluding: the PAS Design System has one overall performance measure which enables the decision makers to choose the best alternative. However, which overall performance will be used is determined and discussed respectively in paragraph 3.1.7 and 3.1.10.

3.1.4 Definitions of problems, goals and value as applied in PAS

Design problems and *design goals* are key elements of the design-structure of PAS Design System. And the problems and goals are interconnected. They are the basis of PAS as a goal-oriented design system.

“A problem cannot exist without a goal and both goal and problem are subjective” as De Leeuw (2002, pp. 35-38; 279-280) states¹⁸. De Leeuw indicates that this is not a common viewpoint. A problem is often described as a difference between an existing situation and desired situation and he indicates that the objection to this description is that it does not explicitly state that problems are not objective properties of phenomena. In De Leeuw’s approach to problem solving¹⁹ it is necessary to explicitly state who has the problem; the so-called problem holder. De Leeuw (2002, p. 36) defines a problem as follows: “A problem is a situation of subjective discomfort of a stakeholder mixed with a desire to do something about it²⁰. This feeling of discomfort arises from a combination of three factors: goal (the subjective wishes), perception (the reality through the eyes of the problem holder) and reality”. As is shown in **Figure 3.1** (De Leeuw, 2002)

The key concepts are defined as follows:

- “The *reality* is the concrete system relevant to problem-solving, as defined by the problem researcher” (De Leeuw, 2002, p. 36);
- “The *goal* refers to the goal of the relevant problem holder: the situation as the problem holder wishes”(De Leeuw, 2002, p. 37);
- “By *perception*, the reality is meant as the problem user sees it. Perception (perceived reality) is determined by reality, by the goals of the problem holder and by his general view of things. It is the perception framework or the Real Life System (RLS) of the problem holder. This RLS or the world view of a person is the set of assumptions and views that together form his or her (obviously subjective) reality” (De Leeuw, 2002, p. 38).

¹⁸ Note that, this corresponds with the facilitated mode in OR where problems are seen as socially constructed entities and subjectivity in a problem situation is unavoidable (see 3.1.2).

¹⁹ De Leeuw indicates that management as problem solving is useful to formalize the methodological side of (the approach to) management.

²⁰ De Leeuw (2002, p. 282-284) distinguishes three types of problems; perception-, objective- and reality-problems. Reality-problems are problems for which solutions need to be found by altering the reality and are the focus in this research.

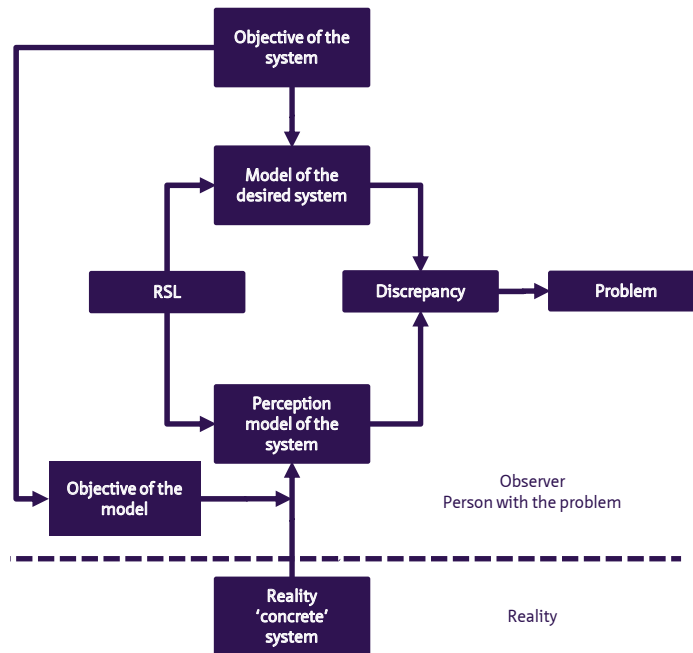

FIG. 3.1 Problem origination Note adapted from De Leeuw, 2002, p. 36

In order to further clarify this, De Leeuw explains that in certain management literature it is usual to refer to a 'problem owner': this person (has been given the assignment) to solve the problem. It is clear that this does not refer to the person that has the problem, as referred to above, because the subjectivity and personal connection to the problem is not central. This means that there cannot be a problem without a problem holder. A problem can be related to an actual situation or a future situation. In the latter, the problem holder expect that an undesired situation will occur De Leeuw (2002, pp. 34, 35, 285).

Problems are, as stated above, not objective properties of phenomena. Objective is opposite to subjective, objective is (formal) "existing outside the mind as something real, not only as an idea. A subject is one who perceives or is aware; an object is the thing perceived or the thing that the subject is aware of"²¹. When looking at the technical definition of tangible in the Longman dictionary online it is "if something is tangible, you can touch or feel it' whereas 'intangible things have value but do

²¹ <https://en.wiktionary.org/wiki/subjective#Etymology>

not exist physically – used in business' an intangible quality or feeling is difficult to describe exactly”.

In general, in architecture qualities of products may be classified under two general categories that in practice often interrelate and overlap as explained by Volker (2010, p. 17):

- "Technical, physical, hard, functional, objective or tangible qualities;
- Perceptual, soft, subjective, judgmental or intangible values".

“Intangible characteristics refer to a personal response to built form, people’s perception of space, texture, color and light, the meanings and associations attached by people to places or the way by which people assign aesthetic qualities to their surroundings” (Bártolo; Vitruvius & Morgan, in Volker 2010). According to Gerritse (2008) intangibles are vital to architectural design but often suppressed in discussion about the realization of a building.

Similar, criteria or values play a role in CRE alignment. De Vries, Van der Voordt and Arkesteijn (2004) also divide values (i.e. criteria) into tangible versus intangible value but add the distinction of financial versus non-financial value (see [Table 3.2](#)). Many other valuable categorizations also exist (for example Appel-Meulenbroek, 2010; De Vries, 2007; Den Heijer, 2011; Riratanaphong, Van Der Voordt & Sarasoja, 2012). In the ‘Added value of facilities management, concept, findings and perspectives’ Jensen, Van der Voordt, Coenen (2012) they are elaborated upon and compared.

TABLE 3.2 Value matrix Note from De Vries et al., 2004 visualized by Van der Zwart, 2014, p. 219

	financial	non- financial
tangible	A tangible financial value	A tangible non-financial value
intangible	B intangible financial value	B intangible non-financial value

Van der Zwart (2014) dedicated in his dissertation a chapter to the concept of value and added value in CRE management and concluded that the concept of adding value is usually linked to various lists of possible real estate strategies that could contribute to the organizations objectives and organizational performance. He concluded after comparing different lists of added values that nine added values are mentioned most: (1) reducing costs; (2) improving productivity; (3) increasing user satisfaction; (4) improving culture; (5) increasing innovation; (6) supporting image; (7) improving flexibility; (8) improving the financial position and; (9) controlling risks.

In addition sustainability was found to be often mentioned as an added value. Value is a multidimensional construct, playing diverse roles, and interpreted in different ways by different people (De Chernatony & Harris, 2000; Jensen, Van der Voordt, & Coenen, 2012) that can be defined as the (subjective) appreciation in achieving stakeholders' overall goals and purposes. He defines value as the performance of a product or service that contributes to the achievement of the goals set by the stakeholders. 'Adding value by real estate' includes stakeholders' valuation and therefore stakeholders' perspectives on real estate should be the starting point for the design and management of the accommodation. Added values of real estate have to be defined in advance (ex-ante) to enable the goals of the stakeholders to be established and also to enable testing afterwards (ex-post) of the design or the building-in-use. As a consequence, generic added values have to be translated into sector specific definitions (Van der Zwart, 2014, pp. 217-218, 236).

Concluding, as basic concept in the PAS System a design goal and a design problem are subjective and linked to a specific problem holder. A problem cannot exist without a goal; a problem is the difference between the 'model of the desired system' and the 'perception model of the system'. In PAS it must be possible that all types of values that stakeholders can be interested in can be taken into account. However, it will prove that the current categorizations can be confusing and are not needed.

3.1.5 Multiple criteria as applied in PAS

Design criteria are key elements of the decision structure of PAS. Criteria give the possibility to make choices. They structure PAS as a multi criteria decision system.

Multiple Criteria Decision Analysis (MCDA) also referred to as Multi Criteria Decision Making (MCDM) is described by Belton and Stewart (2003, p. 2) as "a collection of formal approaches which seek to take explicit account of multiple criteria in helping individuals or groups explore decisions that matter". Decisions matter, to them, when the level of conflict between criteria or different stakeholders assumes proportions that intuitive decision making is no longer satisfactory. MCDA is "an aid to decision making, a process which seeks to: Integrate objective measurement with value judgement and Make explicit and manage subjectivity" (Belton and Stewart, 2003, p. 2).

Concluding: a basic concept for PAS is the multi criteria decision making approach.

3.1.6 Specification and modeling of design problems in PAS

To model an accommodation strategy design problem in PAS is the clarification of design objectives and constraints and the establishment of metrics for objectives. To specify functions of the future accommodation methods of engineering design are applied.

Design engineering from Dym and Little (2004) and business management from De Leeuw (2002) stress the importance of understanding the client statement. Dym and Little (2004, p. 50) explain that "... it is important to understand the client's problem and to develop an engineering definition of the problem. A clarification by the designer is important according to them, because the stated objective by the client can be prone to errors, bias and implied solutions. Errors may include incorrect information, faulty or incomplete data, or simple mistakes regarding the nature of the problem. Biases are presumptions about the situation that may also prove incorrect because the client or the users not fully grasp the entire situation. Implied solutions, that is, the client's best guesses at solutions, frequently appear in problem statements. While implied solution offer some usefull insight into what the client is thinking, they may restrict the design space and sometimes fail to actually solve the problem".

A clarification can be reached by asking questions and presenting the answers in a list of attributes. Mostly these statements are different because they relate to different intellectual objects. The attributes consist of objectives, functions, constraints and implications.

- **Objectives** describe what the designed artefact will be like, that is, what the final product will be and what qualities it will have. As such, objectives detail attributes and are usually characterized by present particles such as 'are' and 'be'. Objectives or goals are the design tries to achieve and are given in the clients language (Dym and Little, 2004, pp. 8, 52, 87);
- **Constraints** are limits that a design must meet to be acceptable. Constraints enable us to identify and exclude unacceptable designs. Constraints are restriction or limitations on a behavior or a value or some other aspect of a designed object's performance. They are typically stated as clearly defined limits whose satisfaction can be framed into a binary choice (Dym and Little, 2004, pp. 8, 52, 59).
- **Functions** are the things a design is supposed to *do*, the actions that it must perform, with a particular focus on the input-output transformations that the artefact or system will accomplish and are usually characterized by active verbs. Functions are the language of the engineer in which the objectives are translated into terminology

that helps the designer(s) realize those needs and measure how well we meet them (Dym and Little, 2004, pp. 53, 87)';

- **Implementations** or means are ways of executing those functions that the design must perform. These are the items on the attribute list that provide specific suggestions about what a final design will look like or be made of, so they often appear as 'being' terms. Implementations are very much solution dependent (Dym and Little, 2004, p. 53).

Mapping the problem is very important, because one needs to determine who has which objectives and what the goals exactly mean. Therefore, he has included the diagnosis phase as the first phase in his so-called DAC model. In this phase problems are made explicit preferably by appointing performance indicators (also referred to as indicators, criteria or target vectors or characteristics). He distinguishes between instrumental and functional judgments that are connected as cause and effect. It is very important to distinguish between, on the one hand, goals and / or performance indicators and, on the other hand, variables that are believed to promote performance. In this view, performance measurement systems are implicitly or explicitly based on the system approach and can be seen as input-output system. This is shown in **Figure 3.2** (De Leeuw, 2002, p. 303). The difficulties of performance measurement can be explained using this black-box. Pure output measurement has two difficulties, as De Leeuw explains. The first concerns the extent to which you actually measure the target achievement and the second that the degree of goal achievement is not only dependent on one's own effort, but also on environmental influences that cannot be influenced. A measure of performance that is preferred in many cases relates to both input and output and is expressed in the term *added value*. If no valid output indicators, throughput variables can be used, but that only makes sense if a reasonable statement about the goal achievement can be made (De Leeuw 2002, pp. 288, 303, 304).

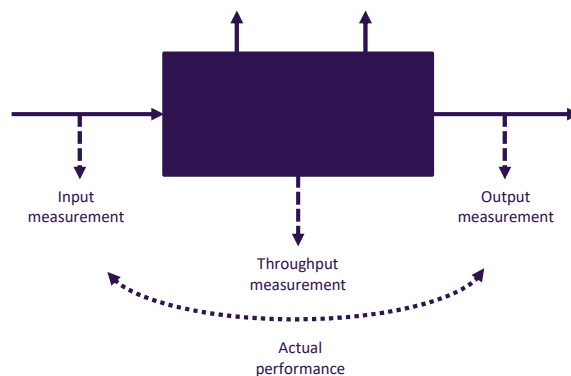

FIG. 3.2 Performance measurement as input-output system Note adapted from De Leeuw, 2002, p. 303

Concluding: as a basic concept goals will be translated into well-defined criteria by dividing them into objectives and constraints and if needed functions and implementations. Furthermore, stakeholders can use both output, throughput and input indicators.

3.1.7 PAS as a multi actor design-decision-management system

In PAS a number of designers/decision makers (the *actors* belonging to a number of different organizations) all pursuing different goals, discuss *interactively* alternative accommodation strategies and form together a design for an strategy which will be followed by de corporation.

In a multi-actor situation a hierarchic relation between actors exists, meaning that they come from the same organization. In an inter-actor approach actors of different organizations are involved. The starting point in PAS is the multi actor situation, however, with blurring boundaries between organization's a multi-actor situation can be extended into inter-actor situation.

This multi-actor approach in combination with the subjective view on problems coincides with the so-called paradigm of the multi-mind systems (Gharajedaghi, in De Leeuw 2002, p. 217). "Problems in this setting are referred to by Ackoff as a 'mess' a system of problems and problem holders" (De Leeuw, 2002, p. 285).

As basic concept, multi stakeholders are involved but they have a more specific role than in regular MCDA processes. The actors are seen as designers and decision makers. Van Loon interpreted the terms *designer* [decision maker], *group* and *optimum result* more broadly than is common in established design [decision] methodology:

- A designer is anyone who has an impact on a design (whether professional or not);
- The group of designers therefore also includes non-professionals; they decide together when their result is optimum;
- A design is a proposal for the use of resources (ideas to be applied) selected from a collection of available resources (applicable ideas) (Van Loon, 1998).

Van Loon (1998) thereby consciously distances himself from the position adopted by many professional designers who believe that professional group optimization must be regarded distinct from, and a necessary prerequisite for, social group optimization. Van Loon (1998, p. 306) therefore defines that "There

is an optimum interorganizational design when several designers cooperating on an interorganizational basis have selected a design solution in an explicit group procedure; this solution is part of alternatives that the designers have drawn up; and this collection lies within the permitted solution space of those concerned.” His interorganizational design and decision making is based on four principal fundamental principles: methodological individualism; Pareto’s criterion; concept of collective action and parallel decision making positions.

Whereas Van Loon indicates that it is impossible to distinguish between professionals and non-professionals, De Leeuw (2002, p. 260) has a similar conclusion: ‘a strict division of roles between decision makers, decision preparation and implementation is fiction because on the one hand many decisions are made in governmental preparation of decisions and on the other hand it is not realistic (proved) that all government officials are neutral in all cases’.

Concluding, PAS is a multi-actor approach where the actors are as individual and as group ‘designers’ and ‘decision makers’.

3.1.8 PAS as a prescriptive mathematical decision system

The core of PAS is a *mathematical multi actor design decision model*. The model is based on a complex of relationships between mathematical quantities, specified as different categories of variables and parameters and represents the accommodation strategy design problem in a logically consistent way.

Mathematical decision modeling is part of the hard systems approach and is used to choose the best or satisficing alternative. When referring to models it needs to be clear what kind of models are meant in this thesis. In this thesis, the following definition of a model is used.

- “A model is a system that (over a period of time) is an image of aspects of another system that is used in a given situation and whose similarity relates specifically to those aspects which, given the purpose of use, are relevant” (De Leeuw, 2002, p. 125).

De Leeuw (2002) explains that models are systems that are used as a tool to study other systems. This is done in order to make systems simpler, more accessible or manageable than the original system and yet appear to be sufficiently similar. This means that models are disposable articles. The models, that are used in this thesis,

are abstract models of a concrete system (De Leeuw 2002, p. 136) and in particular mathematical decision models.

Mathematical decision modeling as basic concept is used because indicates, it has four benefits (i.e. characteristics). Firstly, similar to De Leeuw, a model is a simplified version of the object, making it unnecessary to model the entire object. Secondly, making a model is less expensive than the entire object and makes it possible to avoid costly mistakes. Thirdly, in a model information can be delivered more timely than in a real-world counterpart. And lastly, the most important one a model helps to improve decision making by gaining insight and understanding about the object (Ragsdale, 2008). A mathematical model:

- “uses mathematical relationships to describe or represent an object or decision problem.” (Ragsdale, 2008, pp. 1, 4).

There are different types of mathematical modeling techniques. Ragsdale (2008, pp. 6-7) distinguishes three different categories: prescriptive, predictive and descriptive models (see [Table 3.3](#)). The *prescriptive* models tell the decision maker what actions to take, and this type of model is characterized by known and well-defined functions between the variables, and the value of the independent variables is known or under the control of the decision maker's. For the *predictive* models however, the functional form might be unknown and must be estimated (hence predicted). In *descriptive* models, the decision problem has a very precise and well-defined functional relationship between the independent variables, but there might be great uncertainty about the exact values that will be assumed for one or more of the independent variables. In Ragsdale (2008) positions linear programming and goal programming as prescriptive models and simulation as a descriptive model.

Concluding: following Ragsdale's classification, the basic concept for PAS is a prescriptive model. It is prescriptive because the form of $f(*)$ is known and well-defined (see basic concept goals oriented system approach and preference measurement) and the values of the independent variables are under the decision maker's (i.e. all stakeholders) control.

Although PAS as a design and decision methodology is prescriptive, this is not the case for the mathematical theories used in the approach. Binnekamp (2010, p. 29 based on Barzilai 2010, pp.11-12) explains that “... Von Neumann and Morgenstern's utility theory, as well as its later variants, are mathematical theories and since mathematical theories do not dictate assumptions to decision makers, there is no basis in mathematical logic nor in modern utility for the claim that utility theory is normative or prescriptive”.

TABLE 3.3 Categories and characteristics of management science modeling techniques Note from Ragsdale 2008, p. 6. From Ragsdale. Managerial Decision Modeling, Revised, International Edition (with Student CD-ROM, Microsoft Project Management 2007 and Crystal Ball Pro Printed Access Card), 1E. © 2008 South-Western, a part of Cengage, Inc. Reproduced by permission. www.cengage.com/permissions

Category	Model characteristics		Management science techniques
	Form of $f(*)$	Values of Independent variables	
Prescriptive models	Known, well-defined	Known or under decision maker's control	Linear Programming, Networks, Integer Programming, CPM, Goal Programming, EOQ, Nonlinear programming
Predictive models	Unknown, ill-defined	Known or under decision maker's control	Regression Analysis, Time series Analysis, Discriminant Analysis,
Descriptive models	Known, well-defined	unknown or uncertain	Simulation, Queuing, PERT, Inventory models

Note that there is a difference between a good decision and a good outcome (Ragsdale, 2008, p. 110). A good decision does not always result in (and cannot guarantee a) good outcomes.

3.1.9 Preference measurement in PAS

The selection of the best (most preferred) accommodation strategy out of a set of alternative strategies in PAS is done by means of a mathematical preference measuring model.

The foundation of decision theory is preference measurement. Preference is synonymous to choice as we choose those objects that we prefer. Barzilai (2010) states that the mathematical foundations of social science disciplines, including economic theory, require the application of mathematical operations to non-physical variables. A non-physical variable such as preference²² describe psychological or subjective properties (Barzilai, 2010).

²² In this thesis, preferences are stated preferences, also referred to as espoused preferences. Stated preferences are opposite to revealed preferences or preference-in-use and "It should be noted that what people say they their preferences are – their espoused preferences – may be different from what they actually are as can be inferred from their observable behaviour – their preference –in-use" Binnekamp, et al. (2008, p. 281). Revealed preference theory (Samuelson, on Wikipedia, n.d.) is a method of analyzing choices made by individuals [they] assume that the preferences of consumers can be revealed by their purchasing habits.

Barzilai (2010) explains the purpose of mathematical modeling of measurement in current terminology as follows:

The purpose of modeling the empirical system (E) by the mathematical system (M) is to enable the application of mathematical operations on the elements of the mathematical system M. To clarify what is meant by 'the mathematical modeling of measurement' some terminology is required. By an empirical system E we mean a set of empirical objects together with operations (i.e. functions) and possibly the relation of order which characterize the property under measurement. A mathematical model M of the empirical system E is a set with operations that reflect the empirical operations in E as well as the order in E when E is ordered. A scale s is a mapping of the objects in E into the objects in M that reflects the structure of E into M. The *Principle of Reflection* is an essential element of modeling that states that operations within the mathematical system are applicable if and only if they reflect corresponding operations within the empirical system. In order for the operations of addition and multiplication to be applicable, the mathematical system M must be:

- 1 A field if it is a model of a system with an absolute zero and an absolute one;
- 2 A one-dimensional vector space when the empirical system has an absolute zero but not an absolute one;
- 3 A one-dimensional affine space, which is the case for all non-physical properties with neither an absolute zero nor absolute one.

Errors have been revealed at the foundations of preference measurement by Barzilai because "Addition and multiplication are not applicable in von Neumann and Morgenstern's utility model, which underlies utility theory, because its axioms are not the axioms of a one-dimensional affine space. This is also the case for later formulations of utility theory" Barzilai (2010).

The next step Barzilai (2010) made was to reconstruct the foundations. In order for the operations of addition and multiplication to be applicable on *preference scale values* the mathematical system must be a one-dimensional affine space. Based on this, Barzilai developed a theory of (preference) measurement, a practical evaluation methodology for constructing proper preference scales, Preference Function Modeling, and a software tool that implements it, Tetra.

Concluding: PAS is based upon Barzilai's proper preference scales and the practical methodology PFM. This enables decision makers to take into account both *physical* and *nonphysical* variables. Following Barzilai, all physical properties are translated into non-physical properties (i.e. preference) and aggregated into one overall preference score. This core concept will be explained more in-depth in paragraph 3.2.

Recall, that in the section definitions of problems, goals and value a matrix is presented with value categorizations (tangible and intangible; financial and non-financial). In PAS decision makers should be able to incorporate any of those four values types in their decision making. In mathematics this distinction into these four types or any other categorization is not necessary. Barzilai (2010) separates properties of objects into *physical* or *non-physical* properties of an object.

3.1.10 The overall preference score as performance measure in PAS

Barzilai's proper preference scales and his Preference Function Modeling in PAS made it possible to calculate an overall preference score. This score is able to include all types of values and all stakeholders.

In the shareholder approach as discussed by Jensen (2010) (see paragraph 3.1.3) value maximization is used as financial performance measure. The objections towards financial measures are discussed.

A fundamental objection towards any monetary measure is that price is not a property of a physical object (Barzilai, 2015, 2016). Barzilai (2016, p. 1) explains this by comparing the demand theories of Marshall's and Hicks: "Demand quantities are determined in Marshallian demand theory under the assumption that consumers maximize their utility while satisfying a budget constraint. In contrast, Hicksian demand quantities are determined under the assumption that consumers minimize their expenditure while keeping the value of their utility function constant. The fact that these contradictory assumptions produce different demand quantities raises obvious questions: Which of these demand theories is the correct one? Are consumers Marshallian or Hicksian?". Barzilai (2015) shows that theory can be simplified and he uses an example of buying goods at the market "As is well known, the value of money is different from money. Both Marshall's and Hicks's theories (and the intermediate ones as well) take into account consumers' preferences for tomatoes and cucumbers but ignore their preference for money. This is an elementary error in current economic theory". He further explains that "when consumers buy tomatoes and cucumbers they exchange money for goods. They must- and they do – take into account their preference for money in addition to their preference for the goods. Contradictions are avoided and the theory is simplified when this transaction is viewed as (i) an exchange of goods, (ii) with money being one of the goods, and (iii) preference for all goods is taken into account".

Disadvantages of social cost and benefit analysis

Some other disadvantages of monetary or quantified measures are discussed by Mouter (2012) in his study into social cost-benefit analysis²³ (SCBA) as it is used in the Netherlands. This form of SCBA has specific advantages with respect to the MCA (see paragraph 3.1.3) because it strives to measure all relevant aspects of prosperity of a project and convert it into a quantitative unit (monetized or not)²⁴.

In this study improved transparency is one of the main advantages of the SCBA. Both the choice situation becomes more transparent for the decision maker and it makes decisions by decision makers more transparent and therefore more transparent for other stakeholders. Two disadvantages are especially relevant in this research. Firstly, that the ideal of the SCBA to include all the prosperity effects of a project is not feasible in practice (a.o. Odgaard et al.; Mackie, in Mouter, 2012). Secondly, that an inherent limitation of the application of this SCBA in practice is that one effect can be more difficult quantified / monetarized than the other effect. The result of this is that the difficult to quantify / monetarize effects are presented in an unbalanced manner. Mouter (2012, p. 10) explained this phenomenon by referring to Mishan's 'horse and rabbit stew problem': "if you take one horse and one rabbit, no matter how you combine them the taste of horse dominates the stew. Similarly, if you take one set of quantifiable impacts and one set of non-quantifiable impacts in an appraisal, one set will dominate" (Mouter, 2012).

Mouter (2012) also notes the fundamental aspect that was discussed above by Barzilai. One of the ethical aspects he found to be of importance is the fact that the SCBA assumes 'willingness to pay' and does not take into account the difference in 'capacity to pay'.²⁵

Concluding: in PAS, all physical and non-physical criteria are expressed in preference, also the preference for receiving and spending money. By doing so, the restrictions as formulated by Barzilai and others, are avoided.

²³ abbreviated in Dutch as MKBA

²⁴ In this SCBA the basic information is standardized so that the prosperity effects can be compared and the discussion is about specific figures but differences in methodological visions can be avoided (Mouter, 2012, pp. 5-6).

²⁵ Note that this related to the former objection that price is not a physical property of an object.

3.1.11 PAS as a problem solving system

By viewing a designed accommodation strategy (generated by PAS) as a solution for an organization's strategic accommodation problem PAS is a *problem solving system*. Design as problem solving leads to an instrumental view on the management of the design process.

One is not only concerned with understanding reality but also on the basis of that understanding intervening in that reality. Intervening in reality is steering and (re) designing that reality. De Leeuw (2002, p. 215) uses the following descriptions of a design and designing:

- “A design is a model of a future (realizable) system that exhibits the required behavior in the concerning future environment. That model is mostly abstract, but can also be concrete;
- Designing is a systematic and creative process of activities with the aim of creating a model of a future system that delivers the desired performance taking into account the preconditions (functional process).”

“A design process is a transformation of a problem situation into a solution” as De Leeuw (2002, p. 216) states. This approach is concretized and visualized in a generally usable scheme of management as problem solving and designing. De Leeuw (2002, p. 217) calls this approach the diagnosis, design and change-model²⁶ (see [Figure 3.3](#) (De Leeuw, 2002)).

Designing according to De Leeuw (2002) is often *redesigning* because usually there already is something else, i.e. an organization. This is similar to CRE alignment where an (large) organization always starts with the CRE portfolio that already exists.

Whereas, De Leeuw approaches and defines design from a management perspective, a deeper understanding of design can be obtained by looking at design engineering.

- “Design engineering is the systematic, intelligent generation of specifications for artifacts whose form and function achieve stated objectives and satisfy specified constraints” (Dym and Little, 2004, p. 6);
- “Or expressed in more colloquial terms design engineering is the organized, thoughtful development and testing of characteristics of new objects that have a

²⁶ In Dutch the model is called Diagnose – Ontwerp – Verandering, abbreviated as DOV. Note that in this thesis the last phase 'change' process is outside of the scope.

particular configuration or perform some desired function(s) that meet our aims without violating any specified limitations” (Dym and Little, 2004, p. 7).

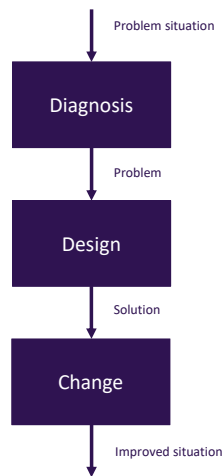

FIG. 3.3 Diagnosis-design-change-model Note adapted from De Leeuw, 2002, p. 217

Design engineering as perspective is chosen because it is a prescriptive process that focuses on how to generate designs. Dym and Little (2004, p. 21) state that ‘some design processes are descriptive, that is, they attempt only to describe the elements of the design process’. It can be noted that such processes compare to the procedural rationality approach as discussed in paragraph 3.1.1. While simple descriptive design processes have the virtue of simplicity, Dym and Little (2004, p. 21) indicate that they are so abstract that they provide little useful advice on how to do a design. Therefore, they converted a descriptive process into a five-stage prescriptive model of the design process that styles the design process as a linear sequence of artifacts (need and final design) and design phases, within which 10 design tasks are situated (see [Figure 3.4](#)). The five stages are problem definition, conceptual design, preliminary design, detailed design and design communication. However, they emphasize that it is not a linear process at all by adding feedback and iteration to the design process. In this prescriptive model Dym and Little define what is done in each stage; each stage requires an input, has design tasks that must be performed and produces an output or product together with sources of information, methods and means. Note that the output of each stage serves as the input to the following stage.

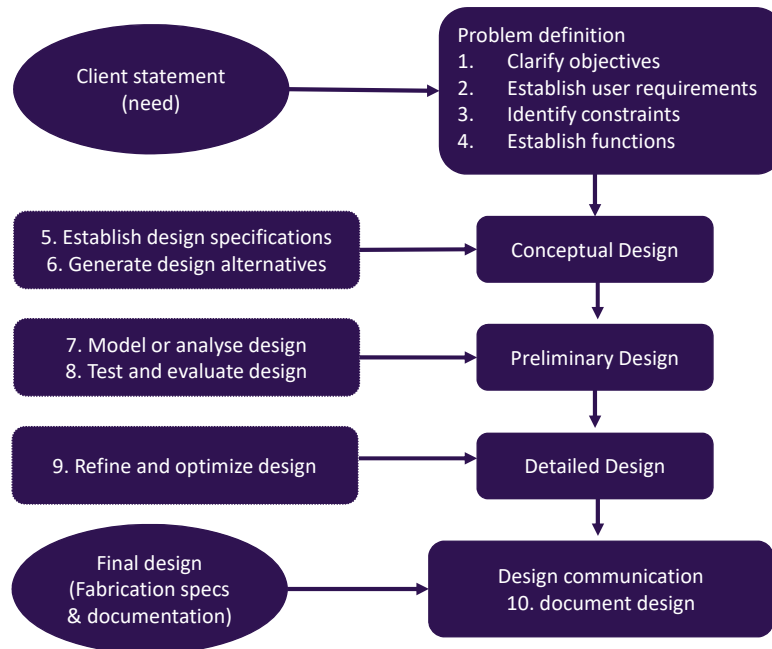

FIG. 3.4 Prescriptive design process © Dym, C., & Little, P., (2004), Figure p. 24, Engineering Design: A Project-Based Introduction, Hoboken. In: NJ.: John Wiley & Sons Inc. Note Used with permission. All rights reserved. No part of this publication may be reproduced, stored in a retrieval system, or transmitted, in any form or any means, electronic, mechanical, photocopying, recording, scanning or otherwise, except as permitted Sections 107 or 108 of the 1976 United States Copyright Act, without prior permission of the original publisher.

Note, that both De Leeuw and Dym and Little emphasize problem structuring as part of the process similar to the importance of goal setting in the soft system approach. De Leeuw refers to this as the diagnostic phase and Dym and Little as the client statement (task 1 to 4) ending in the design specifications (task 5).

Concluding: by seeing PAS as *problem solving system*, De Leeuw defines a design process as a transformation of a problem situation into a solution. Following Dym and Little, PAS uses a prescriptive approach towards design.

3.1.12 PAS as an operational representation of the design (solution) space

In PAS all preferences and constraints of all actors involved are integrated in one overall model which then represents the *design solution* space for the new to design accommodation strategy.

The design space can be defined as a mental construct of an intellectual space that envelops or incorporates all of the potential solutions to a design problem according to Dym and Little. It reflects the number of possible design solutions and the number of design variables. A design space can be large or small. In a large design space either the number of potential designs is very large, perhaps even infinite, or the number of design variables is large, as is the number of values they can assume. In a small design space either the number of designs is limited or small, or the number of design variables is small, and in turn can take on values only within limited range. A large design space is complex because of the combinatorial possibilities that emerge when hundreds or thousands of design variables must be assigned. A well-known approach in design to cope with complexity of decomposing the problem into sub problems and reassembling them. This recomposition of feasible solutions is important (Dym and Little, 2004).

In order to generate potential design ideas and thus *expand the design space* in a goal-directed design Dym and Little state that two main means that can be used: (1) using already available design information (like in handbooks or patents) and (2) team brainstorming. In order to *organize the design space*, i.e. the potential design, in ways that make exploration easy the design space needs to be limited to a useful size. Next to available technologies and external constraints, the main way is to the use the *clients' needs*. The morphological chart (often visualized as a table) is a useful aid to organize the design space; in this chart for each function (rows) that is needed a list of means (columns) is build. The design space is then determined by the combinatorics; any single means for a specific function is combined by the remaining means in all of the other rows (i.e. functions). Next step is to *prune the design space* by identifying and excluding infeasible alternatives. The design space is limited by applying constraints, freezing the number of attributes, impose an order and be realistic Dym and Little (2004).

Design space in linear programming

The design space is also expressed in a mathematical model. The use of linear programming (LP) in the field of architecture has arisen from the basic design problem, being that multiple design alternatives offer a solution to the design

problem. LP offers a technique where the design alternatives do not need to be known a priori, which is the case in architecture. The design alternative is represented as a set of all the relevant design variable values. LP then maximizes an objective function (representing one decision variable) that is subject to a number of constraints (Binnekamp, Van Gunsteren, Van Loon, et al., 2006). The standard form of the LP problem is formulated as follows (Binnekamp et al., 2006, p. 30):

$$\text{Maximize } Z = \sum_{j=1}^n c_j x_j \quad (\text{Objective function})$$

$$\text{Subject to } \sum_{j=1}^n a_{ij} x_j \leq b_j \quad \text{for } i = 1, 2, \dots, m \text{ (Constraints)}$$

$$\text{and } x_j \geq 0 \quad \text{for } j = 1, 2, \dots, m \text{ (Non-negativity constraints)}$$

Design space in linear programming with negotiable constraints

Van Loon (1998) made a distinction between ‘hard constraints’ and ‘soft constraints’: hard constraints are fixed, whereas soft constraints are negotiable and can thus be used to broaden the design space (see [Figure 3.5](#)). In LP this means that the mathematical outcome ‘infeasible’ can be changed to ‘feasible’ by altering the soft constraints. The use of soft, i.e. *negotiable constraints* makes LP suitable for group decision making. The LP model is used to create a solution space in which the ultimate solution (=joint goal) can be found (Van Loon, Heurkens, Bronkhorst, 2008, p. 11).

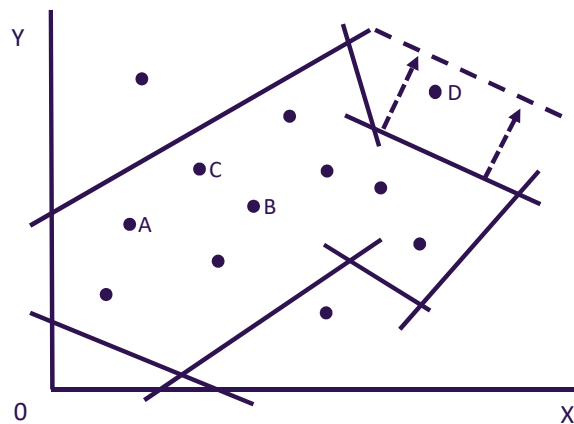

FIG. 3.5 Design space in LP with negotiable constraints Note from Van Loon et al., 2008, p. 11

Concluding, in PAS the design space is a basic concept and will be expressed in a mathematical model, while linear programming will only be used partially (see next section).

3.1.13 The Preference-Based Design method as applied in PAS

To 'solve' the accommodation design problem PAS uses the Preference-Based Design method. And PAS is structured around this method.

The PBD method (Binnekamp, 2010) uses the optimization framework of linear programming (LP) and uses Barzilai's new methodology, Preference Function Modeling, for measurement, evaluation, and decision making by a single decision maker or a group. The first means he uses constraints for expressing each decision maker's interests or criteria in terms of allowed decision variables value ranges and relationships between decision variables in order to define all feasible alternatives. A *design alternative*²⁷ is then a combination of decision variable values and its feasibility is defined by the constraints and allowed decision variable value ranges (Binnekamp, 2010, p. 3). The second means he uses PFM to order these alternatives on overall preference in order to find the alternative with the highest overall preference rating.

This methodology (Binnekamp, 2010, p. 85) thereby 'removes the limitations that were encountered in group design decision making problems using LP models. The fundamental limitations in these models are that they:

- 1 only allow single objective optimization thus satisfy only one interest of one decision maker thereby not extending to group decision making, and
- 2 the constraints divide all possible solutions into either feasible or infeasible ones. This leads to 'black' (excluded) or 'white' (included) situations, where a design is either feasible or not, i.e. no 'grey' situations exist which could eventually be acceptable to decision makers. This means this technique poorly reflect a decision maker's preferences.

The PBD removes all limitations of using either LP, Goal Programming (GP) or Multi objective linear optimization (LMOP) as it removes the harsh division of solutions into

²⁷ This definition is taken from the LP technique

feasible or infeasible and the linearity requirement by introducing curves to represent how decision variable values relate to preference ratings. It enables optimization on multiple objectives by selecting the best design alternative based on the decision variables. PBD also removes the weighted sum limitation by including the PFM algorithm to yield an overall preference scale. Furthermore, it removes the harsh distinction between feasible or infeasible solutions. A solution is only infeasible if it does not meet the design constraints.

Thereby, PBD methodology removes the two limitations as, being built upon PFM, it extends to group decision making (limitation 1) and has a sound mathematical foundation for measuring preference (limitation 2). The PBD methodology is successfully applied to cases at a building and area level, but, as of now, has not been applied at a portfolio level.

Concluding, as second core concept in PAS the PBD methodology is used to design alternatives. This core concept will be explained more in-depth in paragraph 3.3.

3.1.14 **PAS as a design management system**

The procedural and structural aspect systems of PAS give the opportunity to use the system as a *design management* (steering) system focusing on managing the strategic accommodation design formation process.

‘Management as steering’ is a collection of ideas about steering and about the way in which these can be used to make representations and models for analysis and design. The starting point is the assumption that it is possible and useful to approach reality in this way (De Leeuw, 2002, p. 150). Thereby, De Leeuw defines steering as any kind of directional influence. This a broader view on steering which is often interpreted more restrictively.

De Leeuw (2002, pp. 152-153) explains his view as follows:

- 1 Completeness, explicitness, measurability and consistency of goals is not required in order to apply steering;
- 2 Steering does not have to succeed to be named accordingly;
- 3 Steering includes change of structures and goals;
- 4 Not steering is also steering;
- 5 The prevention of change is also steering;
- 6 There is a distinction between the manager (driver) and steering.

Management as steering is based on the systems approach. De Leeuw (2002, p. 151) states that “In the case of steering, always at least two subsystems are involved: the system that is steered, i.e. the steered system, in short (SS) the steering unit (SU).” The SU influences the SS with one or more steering measures and the SS provides information to the SU. In this SU/SS system there is also an exchange of steering measures and information with the environment of the system (see [Figure 3.6](#)).

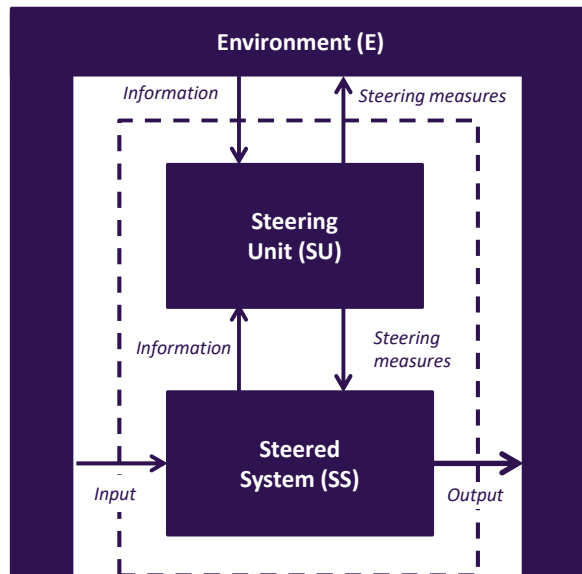

FIG. 3.6 SU/SS system Note adapted from De Leeuw, 2002, p. 155

De Leeuw explicitly mentions in his definition of steering that this is possible regardless the success of the steering measures. A measure is called effective (De Leeuw, 2002, p. 157) if the measure has the intended effect and is called efficacy if it helps in the right direction.

Concluding, in PAS management is seen as steering and steering is any kind of directional influence. In this basic concept it is assumed that it is possible and useful to approach reality in this way.

3.1.15 PAS as Human Activity System

All actors involved in the accommodation design process act within PAS. They make choices, they propose sub solutions, interact and evaluate. PAS is as such a human activity system.

PAS is based on both the hard and soft systems approach with primarily the facilitated operations research mode as foundation (see paragraph 3.1.1). The soft systems approach enables the decision makers to set goals, i.e. to determine which goal(s) need to be achieved. Recall, that in the soft system approach (often linked to the interaction perspective) the unanalyzed problem situation is the starting point. The human activity system (HAS) is a main concept of the *soft systems approach*, according to De Leeuw (2002).

A HAS is a goal-oriented system of human activities that bring about a transformation process (based on Barnard, Miller & Rice and Checkland in De Leeuw, 2002, p. 219). The essence of the transformation process becomes concise from a functional perspective (what the system does or produces) in the root definition. A root definition describes the essential transformation process of an HAS by filling in a so-called CATWOE. Checkland's CATWOE is an acronym that stands for *clients, actors, transformation, weltanschauung, owners* and *environment*. De Leeuw (2002, p. 221) also explains that in his experience it is not always necessary to use all elements of the CATWOE. He adds that a HAS has multiple aggregation levels and therewith the structure of a hierarchical system. A HAS usually includes several managed systems and a steering unit that controls the resources available to the HAS. It is essential that there are more (sometimes even many) different perceptions of a HAS in which the so-called Weltanschauung (compare real life system (RLS)) is expressed.

Concluding, the stakeholders in PAS are seen as designers and decision makers and are part of a human activity system. The essential transformation processes are described in a root definition using CATWOE.

3.2 Preference measurement

In the PAS design and decision method preference measurement, based on Barzilai's proper preference scales and preference function modeling, is a core concept (as explained in paragraph 3.1.9.). In this paragraph this core concept will be explained more in-depth. First of all, the measurement of psychological properties and related problems are discussed. Secondly, the mathematical foundations of preference measurement are explained. Thirdly, the steps of Preference Function Modeling (Tetra) are given. This paragraph is based on Barzilai (2010) and Binnekamp (2010, pp. 23-29).

3.2.1 Measurement of psychological properties

The foundation of decision theory is preference measurement. Preference is synonymous to choice as we choose those objects that we prefer. Barzilai (2010, p. 57) states that "The mathematical foundations of social science disciplines, including economic theory, require the application of mathematical operations to *non-physical variables*, i.e. to variables such as preference that describe psychological or subjective properties".

Barzilai (2010, p. 58) has revealed errors in the foundations of preference measurement and quotes "As Campbell eloquently states ([1920], pp. 267-268) 'the object of measurement is to enable the powerful weapon of mathematical analysis to be applied to the subject matter of science'". In current terminology, Barzilai (2010) explains the *Principle of Reflection* and the purpose of mathematical modeling of measurement as follows²⁸:

The Principle of Reflection is an essential element of modeling that states that operations within the mathematical system are applicable *if and only if* they reflect corresponding operations within the empirical system. In technical terms, in order for the mathematical system to be a valid model of the empirical one, the mathematical system must be homomorphic to the empirical system (a homomorphism is a structure-preserving mapping). A mathematical operation is

²⁸ To clarify what is meant by the mathematical modelling of measurement some terminology might be required. http://www.scientificmetrics.com/downloads/publications/Barzilai_2006_On_the_Mathematical_Modeling_of_Measurement.pdf

a valid element of the model only if it is the homomorphic image of an empirical operation. Other operations are not applicable on scale values.

By *The Principle of Reflection*, a necessary condition for the applicability of an operation on scale values is the existence of a corresponding empirical operation (the homomorphic pre-image of the mathematical operation). That is, *The Principle of Reflection* applies in both directions and a given operation is applicable in the mathematical image only if the empirical system is equipped with a corresponding operation (Barzilai, 2010, p. 5). See **Figure 3.7**.

The task of constructing a model for *preference* measurement is addressed by von Neumann and Morgenstern [1944, paragraph 3.4] indirectly in the context of measurement of *individual* preference. While the operation of addition as applies to *length* and *mass* results in scales that are unique up to a positive multiplicative constant, physical variables such as *time* and *potential energy* to which standard mathematical operations do apply are unique up to an additive constant and a positive multiplicative constant. (If s and t are two scales then for *time* or *potential energy* $t = p + q \times s$ for some real numbers p and $q > 0$ while for *length* or *mass* $t = q \times s$ for some $q > 0$) Barzilai (2010, p. 59).

Barzilai (2010) explained that Von Neumann and Morgenstern's as well as Stevens made a classification based on scale uniqueness, whereas, the classification should be based on the mathematical operations that are applicable instead.

It might be claimed that the characterization of scale uniqueness by implies the applicability of addition and multiplication to scale values for fixed scales, but this claim requires proof. There is no such proof, nor such claim, in the literature because this claim is false ... Barzilai (2010, p. 60).

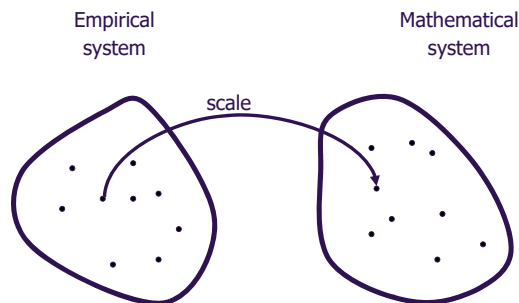

FIG. 3.7 A scale is a mapping of the objects in the empirical system into the objects in the mathematical system Note from Binnekamp, 2010, p. 25

An ordinal empirical system E is a set of empirical objects together with the relation of order, which characterize a property under measurement. A mathematical model M of an ordinal empirical system E is an ordered set where the order in M reflects the order in E . A scale s is a homomorphism from E into M , i.e. a mapping of the objects in E into the objects in M that reflects the order of E into M . In general, the purpose of modeling E by M is to enable the application of mathematical operations on the elements of the mathematical system M and operations that are not defined in E are not applicable in M . In the case of ordinal systems the mathematical image M of the empirical system E is equipped only with order and the operations of addition and multiplication are not applicable in M . In other words, since, by definition, in ordinal systems only order is defined (explicitly — neither addition nor multiplication is defined), addition and multiplication are not applicable on ordinal scale values and it follows that the operation of differentiation is not applicable on ordinal scale values because differentiation requires that the operations of addition and multiplication be applicable Barzilai (2010, p. 62).

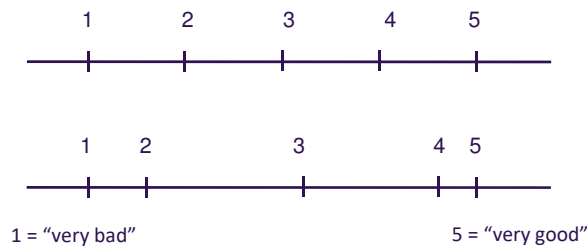

FIG. 3.8 Two example of an ordinal scale; since only order is determined both scales are the same regardless the exact position of digits 2,3 and 4.

This important in our field, because in CRE alignment ordinal scales (see [Figure 3.8](#)) are frequently used to measure psychological or subjective properties.

3.2.2 Mathematical foundations

The purpose of measurement is to enable the application of mathematical operations to the variables under measurement (Barzilai, 2010). Barzilai therefore, classifies measurement scales by the mathematical operations that are enabled on the resultant scales and scale values. Proper scales are scales to which the operations of addition and multiplication (including subtraction and division) are applicable. Those proper scales that enable order and the application of the limit operation of calculus are termed strong scales. All other scales are termed weak.

Barzilai reconstructed the foundations of preference measurement as follows:

In order for the operations of addition and multiplication to be applicable, the mathematical system M must be:

- 1 A field if it is a model of a system with an absolute zero and an absolute one;
- 2 A one-dimensional vector space when the empirical system has an absolute zero but not an absolute one;
- 3 A one-dimensional affine space, which is the case for all non-physical properties with neither an absolute zero nor absolute one.

This implies that for proper scales, scale ratios are undefined for subjective variables including preference Barzilai (2010, p. 81).

The mathematical systems are visualized in **Figure 3.9**.

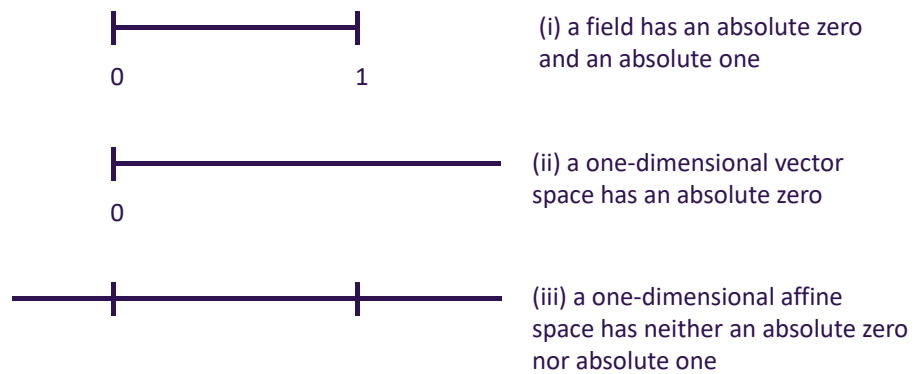

FIG. 3.9 Mathematical systems

Since preference and all non-physical properties neither have an absolute zero or absolute one, the mathematical system must be a one-dimensional affine space in order for the operations of addition and multiplication to be applicable on preference scale values.

... the one-dimensional affine space, is the algebraic formulation of the familiar straight line of elementary (affine) geometry so that for the operations of addition and multiplication to be enabled on models that characterize subjective properties, the empirical objects must correspond to points on a straight line of an affine

geometry. In an affine space, the difference of two points is a vector and no other operations are defined on points. In particular, it is important to note that the ratio of two points as well as the sum of two points are undefined. The operation of addition is defined on *point differences*, which are vectors. Multiplication of a vector by a scalar is defined and the result is a vector. In the one-dimensional case, and only in this case, the ratio of a vector divided by another non-zero vector is a scalar ... (Barzilai, 2010, p. 76).

The expression $\frac{(a-b)}{(c-d)} = k$, where a, b, c, d are points on an affine straight line and k is a scalar, is used in the construction of proper scales. The number of points in the left hand side of this expression can be reduced from four to three (e.g. if $b = d$) but it cannot be reduced to two and this implies that pairwise comparisons cannot be used to construct preference scales where the operations of addition and multiplication are enabled (Barzilai, 2010, p. 81). This is visualized in **Figure 3.10**.

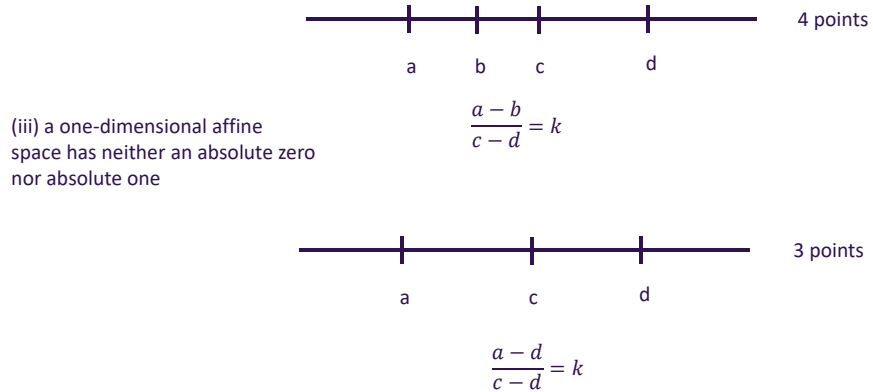

FIG. 3.10 Points on a straight line

Reducing the number of points to two (as is done in the case of pairwise comparison) violates the principle of reflection and is a modeling error. The modeling error is that the axioms of the one-dimensional vector space are used in M while E requires the axioms of the one dimensional affine space.

Binnekamp compared PFM with two other value function methods: Multi Attribute Value Function and Analytical Hierarchy Process (AHP) and with two most prominent outranking approaches, the Elimination Et Choix Traduisant la REalité (ELECTRE) family of methods, developed by Roy and associates at Laboratoire d'Analyse et

Modélisation de Systèmes pour l'Aide à la Décision (LAMSADE), University of Paris Dauphine, and Preference Ranking Organization METHod for Enrichment Evaluations (PROMETHEE) and concluded that none of the scales used by these methods enable the operations of addition and multiplication (Binnekamp, 2010, pp. 37-81).

3.2.3 Preference Function Modeling

Based on his new theory of (preference) measurement, Barzilai developed PFM, a practical evaluation methodology for constructing proper preference scales, and Tetra, a software tool that implements it.

The process of utilizing PFM (single decision maker) is (Binnekamp, 2010, pp. 31-32):

- 1 Specify the alternatives;
- 2 Specify the decision maker's criteria tree;
- 3 Rate the decision maker's preferences for each alternative against each leaf criterion as follows:
 - a For each criterion establish reference alternatives. The most preferred alternative is rated at 100, the least preferred alternative is rated at 0.
 - b Rate the preference for the other alternatives relative to these reference alternatives on the scale established;
- 4 To each leaf criterion assign decision maker's weight;
- 5 Use the PFM algorithm to yield an overall preference scale.

In the Tetra Quickstart Guide (Scientific Metrics, 2002-2016) the process is shown extensively with an example.

3.3 Preference-Based Design methodology

In this paragraph the Preference-Based Design methodology, which has been introduced in paragraph 3.1.13, is explained in depth. The first paragraph explains the objective and foundations of the methodology. The second paragraph explains the concept of the PBD methodology and places it in the context of MCDA

techniques. The third paragraph explains the PBD procedure in detail combined with the definitions that are relevant to this thesis. In the fourth paragraph the tests Binnekamp have done with the methodology are summarized and in the fifth paragraph his conclusions and recommendations are given, while in the sixth and last the PBD procedure is compared to DAS.

3.3.1 Objective and foundations of the Preference-Based Design methodology

Binnekamp explains that “design in the domain of architecture is a complex process where success or failure depends on overcoming many difficulties.” According to him “a substantial amount of these difficulties relates to two prominent characteristics of choice making in architecture:

- 1 multiple designs can fit into one intended purpose, which raises the question: how to choose the design that fits best, and;
- 2 a multitude of decision makers have a say in the design process, which is the problem of group choice making. And choice making is about determining the best choice.”

The main objective of the Preference-Based Design methodology that Binnekamp developed in his thesis is the *challenge of properly integrating preferences in the so-called Open Design methodology*. Rather than following the classical theory of decision making and integrating preference in Operations Research (OR) techniques, the Open Design group uses Linear Programming (LP) models to solve design problems in the domain of architecture (Binnekamp et al., 2006).

Preferences were not mathematically modelled in the open design methodology before, because Van Loon (1998, p. 84), chose the Paretian approach towards preferences using the following motivation “The Paretian approach is eminently suitable for optimization in interorganizational design. It avoids utility measurement, which is difficult to perform, but does not lapse into the subjective evaluation of utility.” At that time, avoiding preference measurement was a valid motivation as classical methodologies for measuring preference lack a mathematical foundation. Binnekamp was able to integrate preference properly by using Barzilai’s theory (2004, 2005). Barzilai’s theory is Binnekamp’s *second foundation* because this theory enables preferences to be taken into account properly, this means in a mathematically correct way. He wants to integrate preferences properly because he states that (Binnekamp, 2010, p. 85) “Design is, for a large part, a process of making

choices. Choosing between the possible options for a given design question is fundamentally an issue of preference. As such, methods of preference measurement and preference-based selection should be applicable to design.”

Binnekamp's (2010, p. 31) main question for his research is:

"How to select the design that meets all decision makers' interests best taking into account each design's attributes". Binnekamp argues (2010, p. 81) that he therefore needs a methodology that:

- 1 "Extends to group decision making;
- 2 Has a mathematical foundation for measuring preference."

The survey Binnekamp (2010, p. 81) conducted into current multi criteria decision analysis approaches "has shown that none of the discussed goal, aspiration or reference level methodologies extends to group decision making. This leaves us with value measurement and outranking methodologies which, with the exception of PFM as shown by Barzilai, all lack a correct mathematical foundation".

3.3.2 Design concept of the Preference-Based Design procedure

Binnekamp therefore proposes a design methodology in which design choices are preference based. As already explained in paragraph 3.1.4 in the design methodology Binnekamp (2010, p. 85) uses

- 1 "Only the design optimization framework of LP;
- 2 Preference Function Modeling to incorporate preferences."

The first means he uses constraints for expressing each decision maker's interests or criteria in terms of allowed decision variables value ranges and relationships between decision variables in order to define all feasible alternatives. Binnekamp (2010, p. 3) uses the following definition "A *design alternative*²⁹ is a combination of decision variable values and its feasibility determined by design constraints and allowed decision variable value ranges". The second means he uses PFM to select from these the alternative with the highest overall preference rating. This methodology

²⁹ This definition is taken from the LP technique

thereby “removes the limitations that were encountered in group design decision making problems when the Open Design group tried to solve these using Linear Programming (LP) models. The fundamental limitations in these models are that they

- 1 Only allow single objective optimization thus satisfy only one interest of one decision maker thereby not extending to group decision making;
- 2 The constraints divide all possible solutions into either feasible or infeasible ones; black or white, no grey which could eventually be acceptable to decision makers thereby poorly reflecting a decision maker’s preferences” (Binnekamp, 2010, p. 85).

This tendency to extreme values is a typical feature of linear programming formulations, making it difficult to find compromising solutions.

3.3.3 Preference-Based Design procedure

Binnekamp’s methodology aims to find the design that is both feasible and most preferred by all decision makers. The procedure (Binnekamp, 2010, pp. 121-122) consists of six steps:

Step 1. Specify the decision variable(s) the decision maker is interested in.

Step 2. Rate the decision maker’s preferences for each decision variable as follows:

(a) For each decision variable establish (synthetic) reference alternatives which define the endpoints of a cubic Bezier curve:

(i) Define a ‘bottom’ reference alternative, the alternative associated with the value for the decision variable that is least preferred, rated at 0. This defines the origin endpoint of the curve, (x_0, y_0) .

(ii) Define a ‘top’ reference alternative, the alternative associated with the value for the decision variable that is most preferred, rated at 100. This defines the destination endpoint of the curve, (x_3, y_3) .

(b) Rate the preference for alternatives associated with the other decision variable values relative to these reference alternatives by manipulating the two control points (x_1, y_1) and (x_2, y_2) .

Step 3. To each decision variable assign decision maker’s weight.

Step 4. Determine the design constraints.

Step 5. Combine decision variable values to generate design alternatives and use the design constraints to test their feasibility.

Step 6. Use the PFM algorithm to yield an overall preference scale of all feasible alternatives.

This procedure incorporates in the second step the use of Bézier curves to relate decision variable values to preference ratings proposed by Binnekamp (2010, pp. 4-5, 115) to offer a design methodology. A practical example of the PBD is displayed in appendix C.

Binnekamp considers *decision variables* to be synonymous to criteria or design variables or properties (Binnekamp 2010, p. 90).

Binnekamp (2010, pp. 55-56) uses “Zeleny [1982, pp. 225-226] to describe the conceptual and technical differences between constraints, goals, and objectives:

- a *constraint* is a fixed requirement which cannot be violated in a given problem formulation. Constraints divide all possible solutions (combinations of variables) into two groups: feasible and infeasible;
- a *goal* is a fixed requirement which is to be satisfied as closely as possible in a given problem formulation;
- an *objective* is a requirement which is to be followed to the greatest extent possible (either by minimization or maximization) given the problem’s constraints”.

A *design space* based on Dym and Little (2004) (see paragraph 3.1.5).

A *synthetic alternative* is an alternative associated with a value for a single decision variable value, regardless of other decision variables and regardless of its feasibility (Binnekamp, 2010, p. 89).

3.3.4 Preference-Based Design applications

Binnekamp applied the PBD in three cases. In the [Table 3.4](#) these cases are summarized.

TABLE 3.4 Summary of cases Binnekamp (2010)

	Case 1 Airport Schiphol and region	Case 2 Stedelijk museum Amsterdam	Case 3 Tilburg area development case
level	Urban	Building	Urban
Type of case	“simulation”	Real	Real
# stakeholders	Role play 4 colleague experts	2	1
# variables	4	12	6
Type of curve fitting	n.a.	3 segment predetermined Bezier curve	5 segment predetermined Bezier curve
Weights per criterion	Assumed equally	Assumed equally	Assumed equally
Intra-stakeholder weights	Not taken into account	Assumed equally	Assumed equally
Constraints	2	4	2
# alternatives	36 feasible alternatives	67 108 864	46656
Overall preference rating of best alternative	59 (second table) (first table 80,144)	46	68.343
Results accepted by stakeholders	Not applicable		Outcome considered to be plausible and satisfactory
Evaluation	Before the model was introduced, design decisions were made that turned out to be either infeasible or unacceptable for the museum staff.		The Tilburg urban development case shows that the Bézier curve is easy to work with and appeals to the decision makers concerned.

3.3.5 Preference-Based Design methodology conclusions and recommendations

Binnekamp (2010, p. 145) concluded that the PBD proposed fulfils both requirements. PBD is built upon Preference Function Modeling (PFM) and extends to group decision making (requirement 1) and has a sound mathematical foundation

for measuring preference (requirement 2). It also removes all limitations of using either linear programming, goal programming or Linear Multi Objective Programming because it avoids single objective optimization and it removes the harsh division of solutions into feasible or infeasible and the linearity requirement by introducing curves to represent how decision variable values relate to preference ratings. It enables optimization on multiple objectives by selecting the best design alternative based on the decision variables.

PBD also removes the weighted sum limitation by including the PFM algorithm to yield an overall preference scale. Furthermore, it removes the harsh distinction between feasible or infeasible solutions. A solution is only infeasible if it does not meet the design constraints. For the decision variables, each score on the Bézier curve is considered to be feasible.

Binnekamp (2010, p. 145) concluded that PBD reflects the decision makers' preferences more accurately than was done by LP, based on applications in architecture and urban planning. This PBD methodology is successfully applied to cases at a building and area level, but, as of now, has not been applied at a portfolio level.

Binnekamp (2010, pp. 145-146) indicates two recommendations in his work:

- 1 A drawback of using a limited amount of Bézier curves is that they, because they are pre-determined, do not purely reflect a decision maker's preferences. Future research aimed at devising a user friendly interface so that the decision maker can directly shape the preference curve is desirable;
- 2 A limitation of the PBD procedure is that it requires generating alternatives by combining *all* values for *all decision variables* and then filtering from these the feasible alternatives using the design conditions. This makes it a 'brute force' approach. As the number of possible combinations equals the number of decision variable values to the power of the number of decision variables, the number of combinations will be very large for more complex problems as these normally have a greater number of decision variables. ... Therefore, given the control and end points of all Bézier curves and PFM's algorithm, an optimization algorithm can be used to directly compute the best design (at least approximately). We then have a design methodology which takes into account each decision maker's preferences. Recall that in fact the 'design' part of the LP process is due to its optimization step.

3.4 Foundations in different scientific fields

In the previous paragraphs, basic concepts and definitions from different scientific fields have been explained. The consequence of this is that there are different names for similar concepts. In order to show these similarities, Dym and Little's prescriptive design process, De Leeuw's DDC model, Barzilai's PFM, and Binnekamp's PBD are compared to DAS which has been introduced in chapter 2.

In DAS the primary vocabulary is *demand*, *supply* and *match* or *mismatch* (Figure 3.11). Demand is also referred to as *need* and supply as *alternatives* or *solutions*. Although, *added value* is the main concept in DAS, it is not visualized as such in the framework. Added value in DAS is represented by the *match* or *mismatch*.

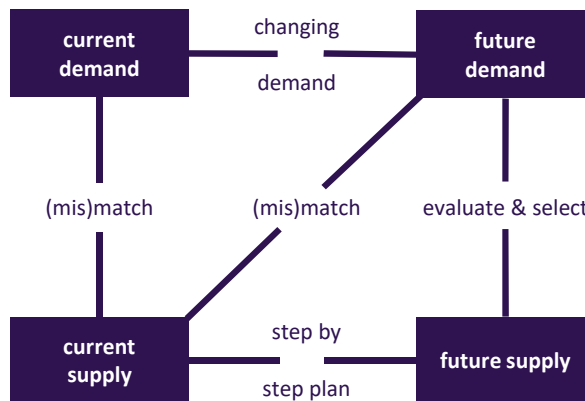

FIG. 3.11 DAS simplified visualization Note simplified DAS adapted from De Jonge, et al., 2009, p. 36), Van der Zwart et al., 2009, p. 3. and Den Heijer, 2011, p. xv

The main concepts as used in design engineering by Dym and Little (2004) are compared to the DAS (see Figure 3.12). What stands out is that they do not distinguish between current and future demand. *Demand* is expressed as *client statement (need)* or *problem definition*, using concepts as objectives, requirements, constraints, functions which are consolidated in design specifications. *Supply* is expressed primarily as *design* or *design alternatives*.

De Leeuw (2002) on the other hand uses the DDC- model which is a more abstract concise framework. His phase of *diagnosis* is similar to DAS task 2 (future demand matching current supply), while the *design* is similar to future supply (see [Figure 3.13](#)).

Barzilai uses a finer grain terminology in preference function modeling and Tetra (Scientific metrics 2002-2016) compared to DAS (see [Figure 3.14](#)). Demand is subdivided into *stakeholders*, *criteria* and *weight* with no overarching name for these terms. In his evaluation methodology foremost *actual alternatives* (i.e. current supply) are used. For step 6 it is explained that in some decision making situations, an *evaluation plan* is set up for the purpose of assessing *future alternatives*. Since the *actual alternatives* are not known when the evaluation plan is set up, *hypothetical alternatives* must be used to define the reference objects for each criterion (Scientific metrics 2002-2016, pp. 8-9).

Binnekamp (2010) in his PBD uses different terminology than in DAS and slightly different terminology than Barzilai. Preference and design are the two main terms of his methodology. Similar to Barzilai, demand is specified by defining decision variables, preferences, weights and constraints (see [Figure 3.15](#)). Future supply is referred to as a design alternative, which Binnekamp (2010, p. 3) defines as a combination of decision variable values and its feasibility determined by design constraints and allowed decision variable value ranges. Design variables are design attributes and he considers decision variables to be synonymous to criteria or design variables or properties. He also uses alternative and solution as synonym.

One important remark needs to be made, because the word value is used in two different ways. Firstly, as the equivalent of preference. Secondly, in the description of a design alternative Binnekamp refers to decision variable values. In the latter, value is different from the first, where value is technically equivalent to preference. Value³⁰, according to the Longman dictionary, is “an amount, which is countable, and technical: a mathematical quantity shown by a letter of the alphabet or sign”.

³⁰ This definition is the seventh definition of value from the Longman dictionary (<https://www.ldoceonline.com/dictionary/value>)

This means that the following concepts are similar and are used interchangeably in this thesis.

- *Demand* – needs- requirements - diagnose

- *Supply* – alternatives– design – design alternative– solution – situation
 - Current supply – current situation – current design
 - Future supply - alternatives– design – design alternative– solution
 - All feasible alternatives = design space

- *Match/mismatch* = value = preference
 - Value is technically equivalent to preference, therefore the value of an alternative is expressed as overall preference score.
 - Value - overall preference score – overall score – overall preference rating - overall preference scale

- *Evaluate and select alternative* = select or choose best alternative
- Best or satisficing alternative – final design –alternative with most added value, i.e. highest overall preference score
- Added value will be calculated as:
(overall preference score current supply) – (overall preference score future supply)

- The terms are sometimes intermingled (like demand and alternative or requirements and alternatives) but often the following duo's are used:
 - demand – supply (economics)
 - requirements – design (design)
 - problem – solution (managerial problem solving)
 - (multi-)criteria – alternatives (decision making)

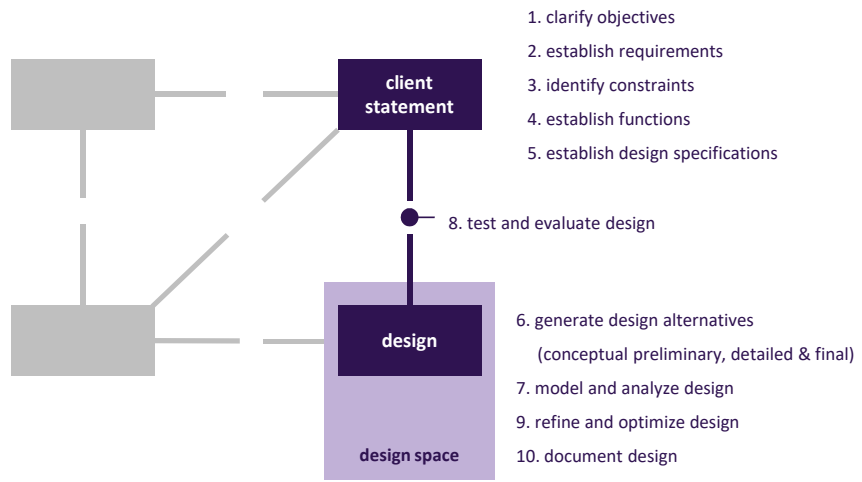

FIG. 3.12 Dym and Little's steps compared to DAS Note simplified DAS adapted from De Jonge, et al., 2009, p. 36), Van der Zwart et al., 2009, p. 3. and Den Heijer, 2011, p. xv

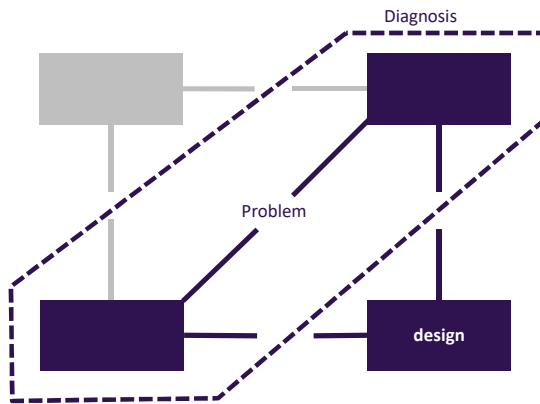

FIG. 3.13 De Leeuw's DDC model compared to DAS Note simplified DAS adapted from De Jonge, et al., 2009, p. 36), Van der Zwart et al., 2009, p. 3. and Den Heijer, 2011, p. xv

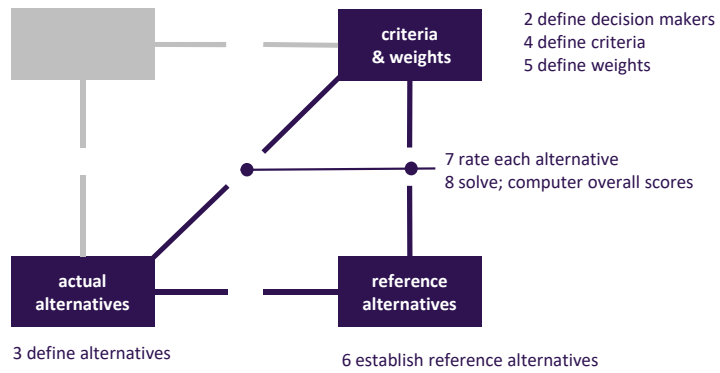

FIG. 3.14 Barzilai's PFM and Tetra compared to DAS Note simplified DAS adapted from De Jonge, et al., 2009, p. 36), Van der Zwart et al., 2009, p. 3. and Den Heijer, 2011, p. xv

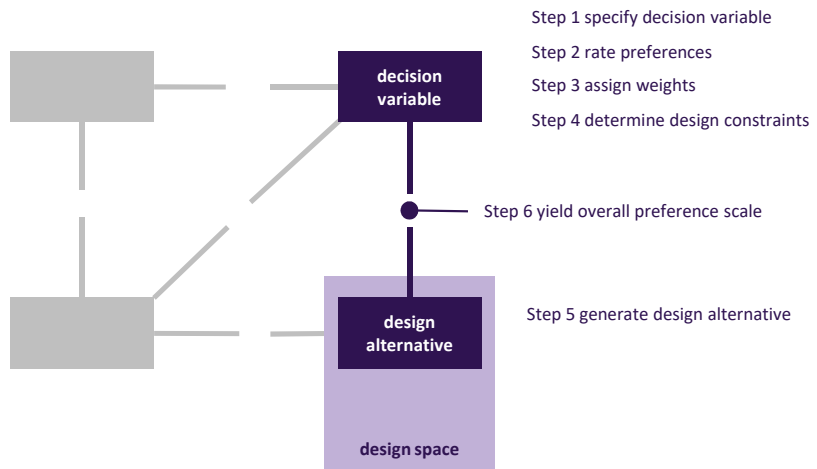

FIG. 3.15 Binnekamp's PBD compared to DAS Note simplified DAS adapted from De Jonge, et al., 2009, p. 36), Van der Zwart et al., 2009, p. 3. and Den Heijer, 2011, p. xv

3.5 Conclusion and comparison

The fifteen basic concepts and definitions from management science, decision theory and design methodology are the methodological aspects, characteristics and features of PAS. By using the fifteen concepts and definitions, past experience benefits the development of PAS.

In PAS all three rationalities are used to open the black-box of decision making in CRE alignment. The *substantive rationality* enables the decision maker to choose an alternative based on the bounded rationality perspective. The *procedural rationality* enables the decision maker to take into account the time perspective when selecting an alternative and the *structural rationality* enables that more than one decision maker is involved. These three rationalities are also used to structure the PAS approach. Next to the three rationalities, Preference measurement and Preference-Based Design are the two core concepts.

Extensive research into existing CRE alignment models has shown that these models still fall short in a number of ways. Eight assessment criteria were logically formulated that would enable CRE manager to do so. These criteria were grouped as follows: selecting an alternative, designing supply and formulating demand. Below, the criteria are compared to the fifteen concepts.

Selecting an alternative

In chapter 2, it was shown that most problems in CRE alignment occur when *selecting an alternative*; none of the models have an overall performance measure that incorporates both quantitative and qualitative criteria, and use correct measurement. These requirements were referred to as respectively, indisputable and correct. PAS is based upon Barzilai's *strong scales* and the practical methodology preference functional modeling. PFM has an *overall preference score* that is able to incorporate all types of values: both financial and non-financial, tangible and intangible, quantitative or qualitative. From a mathematical point of view this or other value categorizations in CRE alignment are unnecessary; in PAS Barzilai only *physical* and *non-physical* criteria are distinguished. Following Barzilai, all physical properties are translated into non-physical properties (i.e. preference), including the preference for receiving and spending money, and aggregated into one overall preference score. By doing so, the restrictions as formulated by Barzilai and others, are avoided.

In order to select an alternative, PAS is based on the hard facilitated goal-oriented

systems approach. The basis is Ackoff and Sasieni's (1968) notation $U = f(X_i, Y_j)$ that displays the structure of a generic decision making problem where U stands for utility and represents the goal that one wants to achieve. In CRE alignment, *the goal is to achieve an optimal added value*. In this thesis, *value* is technically equivalent to *preference* and expressed in an overall preference score (see [Figure 3.16](#)).

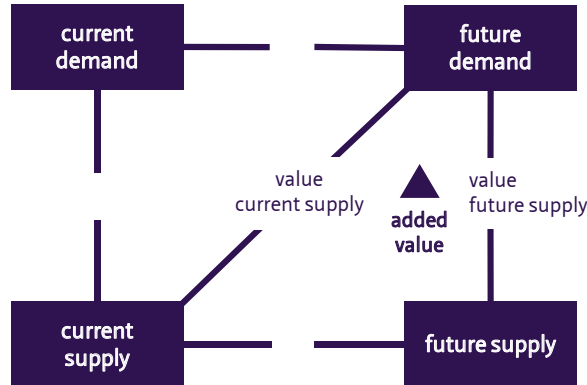

FIG. 3.16 Added value visualized in DAS frame Note simplified DAS adapted from De Jonge, et al., 2009, p. 36), Van der Zwart et al., 2009, p. 3. and Den Heijer, 2011, p. xv

Using the hard goal-oriented systems approach does not mean that the original rationality concept of the 'homo economicus' is used. This rationality concept has been far stretched by Simon's *bounded rationality*; human decision makers are not perfectly informed and also have a limited capacity of information processing. They are not looking for maximum but satisficing alternatives.

This means that, PAS has the ability to be *indisputable* by having one overall preference score and *correct* by using Barzilai's strong scales.

Designing alternatives

In chapter 2, most CRE alignment formulate alternative CRE strategies at visionary level, which than are mostly translated to well-defined criteria. Often, however, they are not translated to the corporate real estate itself, i.e. to the portfolio and building level. It remains unclear how new alternative real estate portfolios are made.

By seeing a designed accommodation strategy (generated by PAS) as a solution for an organization's strategic accommodation problem, PAS is a *problem solving*

system. Design as problem solving leads to an instrumental view on the management of the design process because one is not only concerned with understanding reality but also on the basis of that understanding intervening in that reality. *Designing* is a systematic and creative process of activities with the aim of creating a model of a future system that delivers the desired performance taking into account the preconditions (functional process).

In this design process, the design space can be defined as a mental construct (Dym and Little, 2004, p. 97) of an intellectual space that envelops or incorporates all of the potential solutions to a design problem. It reflects the number of possible design solutions and the number of design variables

PAS uses the Preference-Based Design procedure to 'solve' this accommodation design problem. PBD (Binnekamp, 2010) uses the optimization framework of linear programming and Barzilai's methodology, Preference Function Modeling, for measurement, evaluation, and decision making by a single decision maker or a group. Where, PFM evaluates existing alternatives, PBD is able to design alternatives. A *design alternative* is then a combination of decision variable values and its feasibility is defined by the constraints and allowed decision variable value ranges (Binnekamp, 2010, p. 3). The PBD has removed all limitations of using linear programming as it removes the harsh division of solutions into feasible or infeasible and the linearity requirement by introducing curves to represent how decision variable values relate to preference scores. This means that for all criteria, decision variable values are linked to a preference score. Only for criteria that cannot be expressed in a measurable unit preference is rate directly. PAS is structured around the PBD method.

This means that, with these basic concepts and definitions PAS has the ability to iteratively, design an alternative with optimal added value.

Formulating demand

In chapter 2, it became clear that, when formulating demand, most CRE alignment models take a similar approach. The models authors' indicate that all relevant stakeholders need to be involved to formulate an set of well-defined explicit (qualitative and quantitative) criteria to measure their real estate strategy/vision/objectives. Next to that, they state that stakeholders need to be involved, However, it is not clear how the stakeholders are included; whether they set their own criteria and are involved throughout the process.

PAS uses a soft systems to enable the decision makers to determine which goal(s) need to be achieved. PAS is a multi-actor approach where design goal and a design (reality) problem are subjective and linked to a specific problem holder. In PAS these problem holders are the stakeholders and seen both as individual and as group as 'designers' and 'decision makers'. They express their goals into well-defined decision variables in the PBD methodology. While doing this, objectives can include output, throughput and input criteria.

This means that, with these basic concepts and definitions PAS has the ability to explicitly formulate demand that is personal and integral.

Managing the formation of an accommodation strategy

In PAS, management is defined as steering and steering as any kind of directional influence. The stakeholders are designers and decision makers in PAS and part of a human activity system. The essential transformation processes are described in a root definition using CATWOE. This means that, with these basic concepts and definitions, PAS can be represented as a management system. By doing this, PAS is described from the perspective of the organization that executes the process. This is contrary, to the other concepts and definitions where either design or decision making is central.

Different terminology

The consequence of using basic concepts and definitions from different scientific fields in PAS is that there are different names for similar concepts. In this thesis, the following concepts are similar and used interchangeably:

- Demand – needs- requirements - diagnose
- Supply – alternatives– design – design alternative– solution – situation
- Match/mismatch – (added) value - preference
- Evaluate and select alternative - select or choose best, satisficing or optimum alternative

4 Preference-based Accommodation Strategy design and decision approach

chapter 2	CRE alignment state of the art and scientific gap
-----------	---

Preference-based Accommodation Strategy (PAS)
design and decision approach

Developing PAS		Testing PAS			Evaluating PAS
chapter 3	chapter 4	chapter 5	chapter 6	chapter 7	chapter 8
fifteen basic concepts and definitions from decision, design and management theory	2nd procedural rationality	steps			steps
	3rd structural rationality		stakeholders & activities		stakeholders & activities
	1st substantive rationality			model	model

chapter 9	Reflecting upon PAS
-----------	---------------------

chapter 10	Conclusions and recommendations
------------	---------------------------------

4 Preference-based Accommodation Strategy design and decision approach

One of the long-standing issues in CREM is the alignment of an organization's real estate to its corporate strategy as I have shown in chapter 2. CRE alignment is even defined by some as the *raison d'être* of CREM, as the range of activities undertaken to attune corporate real estate optimally to corporate performance. Even though extensive research into existing CRE alignment models has provided us with valuable insights into the steps, components and variables that are needed in the alignment process, these models still fall short in two ways. Most models pay little to no attention to the design of a new portfolio and to the selection of a new portfolio that adds the most value to the organization.

The Preference-based Accommodation Strategy approach is a design and decision support tool to remedy these shortcomings and thereby enhance CRE alignment. The basic concepts and definitions for PAS have been explained in chapter 3. In this chapter, PAS is presented in its main development phases.

The research methods to develop, test and evaluate PAS are explained in paragraph 4.1. In paragraph 4.2 the main concepts and the three components of PAS are explained. Subsequently, these three components are discussed; the steps of PAS in paragraph 4.3, the stakeholders & activities in paragraph 4.4 and the generic mathematical model in paragraph 4.5. In the last paragraph 4.6, the coherence between the three components is explained as well as the conclusion.

4.1 Research methods to develop, test and evaluate PAS

In this paragraph the main aim of the research is addressed in paragraph 4.1.1 while the formal research method from operations research as used for the development of PAS is explained in paragraph 4.1.2. In paragraph 4.1.3 it is explained how the successfulness of the approach will be tested.

4.1.1 Main aim

The aim of the research is to enhance CRE alignment by improving CRE decision making in such a way that corporate real estate managers are able to determine the added value of a particular corporate real estate strategy quickly and iteratively design many alternative real estate portfolios.

In order to be able to do this two equally important parts need to be addressed:

- 1 Measure added value of a new alternative CRE portfolio:
corporate real estate managers should be able to determine the added value of a particular corporate real estate strategy, i.e. corporate real estate portfolio;
- 2 Iteratively design alternative CRE portfolios:
corporate real estate managers and involved stakeholders should be able to quickly and iteratively design alternative corporate real estate portfolios to find the portfolio with the optimal added value.

The approach should be generic so it can be used for a wide range of real estate portfolios.

The originality of this research to (1) define value as technically equivalent to preference and (2) use a design and decision approach for the alignment problem. By adjusting and expanding the Preference-Based Design procedure as particular technique from design and decision systems tested and evaluated on portfolio level in CRE alignment. This new approach is called the Preference-based Accommodation Strategy (PAS) design and decision approach. PAS is a decision support tool to remedy these shortcomings and thereby enhance CRE decision making.

The research question that will be answered is:

How can the Preference-based Accommodation Strategy design and decision approach successfully be developed and tested on corporate real estate portfolio level in order to enhance CRE alignment?

4.1.2 Research method to develop and test PAS

To answer the research question an appropriate design decision method has to be developed and tested. This developing and testing concerns design methodology and is focused on the question 'how to do' something i.e. how to develop, form, make an accommodation strategy? Methodological design questions can be answered based on operations research methodology that deals with operation-related problems (Barendse et al., 2012)³¹. Operations Research is a discipline that deals with the application of analytical methods to aid decision making and solve organizational problems. PAS is developed and tested in accordance with the five stages of an operations research project (Ackoff and Sasieni, 1968: p. 11):

- 1 "Formulating the problem;
- 2 Constructing the model;
- 3 Deriving a solution;
- 4 Testing the model and evaluating the solution;
- 5 Implementing and maintaining the solution".

PAS will be tested in three pilot studies. It can be argued that the application of a design and decision approach in practice is context-dependent. The results of using the same approach multiple times can be different depending on the people involved in the process, the roles and responsibilities of these people within the organization, the characteristics of the portfolio, i.e. the type of space it is applied to, etc. Applying this approach to multiple context-dependent cases yields more valuable results than just applying it to one case.

³¹ Note that this is in contrast to empirical research that deals with knowledge-related problems ('what is' type of research questions) and provides understanding about the past (Barendse et al., 2012). Empirical research provides knowledge (theories, predictions, concepts) that can be used to explain reality and formal studies produce artifacts (methods, ways of acting, instruments) that can be used to eradicate dysfunction in reality (Van Loon, 1998, p. XXXIII).

Note that in this research problem solving occurs on three different levels (see [Table 4.1](#)).

TABLE 4.1 Problem solving at three levels

Problem solving at three levels		
	Problem to be solved	Problem solver(s)
Level 1	Develop the PAS design and decision method The PBD procedure cannot be used on a portfolio level and the PBD procedure is not tested in practice	Ph.D researcher
Level 2	Build mathematical model In each pilot study to test PAS mathematical models need to be constructed to solve a practical problem	Systems engineer
Level 3	Design alternative real estate portfolio To design alternative CRE portfolios for the problem in practice in a particular pilot study	Stakeholders

In order to perform PAS in the pilot studies (level 3) empirical research is needed in stage 4 'Testing the model and evaluating the solution'. These questions as will be shown are part of PAS and will serve as a background for the model design.

4.1.3 Research method to determine the successfulness of PAS

PAS can be considered a *soft systems approach* because the problem situation is plural. This means that the 'what' question needs to be answered first. In the soft system approach the unanalyzed problem situation is the start. This in contrast to the hard systems approach which starts with an unambiguous problem situation and focuses on 'how the system must be arranged. The classification of PAS as soft system is based on a scheme of different system approaches as presented by De Leeuw (2002, p. 218) where the actors in PAS are pluralistic and mechanic (analyzable). However, it is possible that the actors in PAS can have different images of the situation and have different objectives. This means that it is not known if the structure of the system is transparent or not before the pilot starts.

PAS is considered to be successful if

- 1 The stakeholders are able to perform PAS , i.e. can the stakeholders perform PAS to solve problems?

- 2 If the stakeholders evaluate PAS positively, i.e. do the stakeholders want to use PAS to solve problems?

The first question is answered if the stakeholders are able to solve the practical problem in their pilot study. Therefore, the operations research method as described in the previous paragraph is used.

In order to determine if stakeholders want to use PAS to solve problems another research method is used. To assess the impact of soft operations research methods (Joldersma & Roelofs, 2004, pp. 697-698) is used. They indicate that the impact on problem structuring can be measured in four different ways: (1) experiences with the method; (2) attractiveness of the method; (3) participants' observations on effectiveness of the method; and (4) observers' perceptions of the effectiveness of the method.

Each stakeholder has been interviewed minimally three times during the pilot study to evaluate PAS. In the first interview two questions are posed (see [Table 4.2](#)) and in the second and third interview three questions are asked about the first three aspects (see [Table 4.3](#)). The fourth aspect '*observers' perceptions of the effectiveness of the method*' has been answered by the researcher.

TABLE 4.2 Interview 1

Interview 1	
Evaluation	Questions What is your first evaluation of PAS ?
Expectations	What are your expectations of your participation in this project?

TABLE 4.3 Interview 2 and subsequent interviews

Interview 2 and subsequent interviews		
	Question	Possible aspects
Aspect 1: Experience	What was your experience with PAS ?	User-friendliness of the model, easiness of performing PAS
Aspect 2: Attractiveness	What is attractive of PAS ?	Mathematical model, visualization, involvement
Aspect 3: Effectiveness	Do you think that PAS is effective?	Acceptance of solution, time spent on achieving the solution

4.2 Main concepts and components PAS

The basic concepts and definitions of PAS have been discussed in chapter 3. The approach is based on two main concepts and has three components. The main concepts are explained in paragraph 4.2.1 and the three components are discussed in paragraph 4.2.2.

4.2.1 Two main concepts³²

The main concepts of PAS are:

- 1 CRE alignment is seen as a design and decision process which requires integrating aspects of the domains of design, decision making and problem solving;
- 2 Adding value is a key concept in CRE alignment and therefore it requires the measurement of value. The measurement problem is solved by using a mathematical operational approach from decision theory where value is considered equivalent to preference.

Ad 1. CRE alignment as a group design and decision process

In a design and decision process the optimal portfolio is defined as the portfolio of buildings that best serves the aims of the organization within a particular set of boundary conditions. The most preferred or valuable solution in CRE alignment is sometimes seen as the accommodation with the highest financial performance (Weatherhead, 1997; Englert, 2001; Osgood, 2004). The highest financial performance is often either defined as the net present value (NPV) or as the economic value add (EVA) and is referred to as the shareholders' approach. However, in this research the stakeholders approach is used where all stakeholders are involved and are able to express their requirements in both financial, quantitative aspects (such as square meters) and qualitative aspects (such as aesthetics) s. That means that if - in the phase of selecting the best option, i.e. an alternative – this choice is not only based on financial aspects, then a kind of measurement of all these different values is needed to select the most preferred alternative. Since the decisions on the selection

³² These main concepts and components were published in Arkesteijn et al., (2017, p. 245), text slightly adjusted see numbering of main concepts, addition of words [...] and bold emphasis.

of accommodation strategies are rarely made by one decision maker, this process is regarded as group decision making. This means that measuring values should take place across all actors Arkesteijn et al., (2017, p. 245).

Ad 2. A mathematical operational approach; value is equivalent to preference

To ensure that the CRE alignment process adds value it is necessary to determine both the value of the existing real estate portfolio as well as the value of a proposed alternative portfolio. The assignment of values to objects such as real estate portfolios, i.e., the construction of value scales, is a fundamental concept of decision theory. Since value (or preference) is not a physical property of the objects being valued, it is a personal or psychological (sometimes referred to as “subjective”) variable and the measurement of value requires specifying both what is being valued and whose values are being measured.

To decide is to choose and the alternative that the stakeholders prefer is chosen and they prefer the alternative that adds (most) value. This means that value can be measured by measuring preference, that is, evaluating/judging the alternatives as to the value they add, and in this context, *value* and *preference* are equivalent. Evaluating is a human cognitive judgment which is consistent with the observation that the value of alternatives is a non-physical property of the alternatives and value is a personal/psychological variable. Of course, in multi criteria evaluation, some of the criteria, i.e. variables may be physical, for example, the floor size of a building Arkesteijn et al., (2017, p. 245).

PAS enables CRE managers and the stakeholders to actually calculate the added value of an alternative corporate real estate portfolio. The generic objective of PAS is to open the ‘black box of decision making’ in the existing CRE alignment models and to offer an approach in which it is able to select the best option, on more than financial criteria only.

4.2.2 Three components of PAS

PAS consists of three components based on the three types of rationality as used by De Leeuw (2002) based on Kickert (1979) (in De Leeuw, 2002) (see paragraph 3.1.1). The components are steps (procedural rationality), stakeholders & activities (structural rationality) and mathematical models (substantive rationality) (see [Figure 4.1](#)).

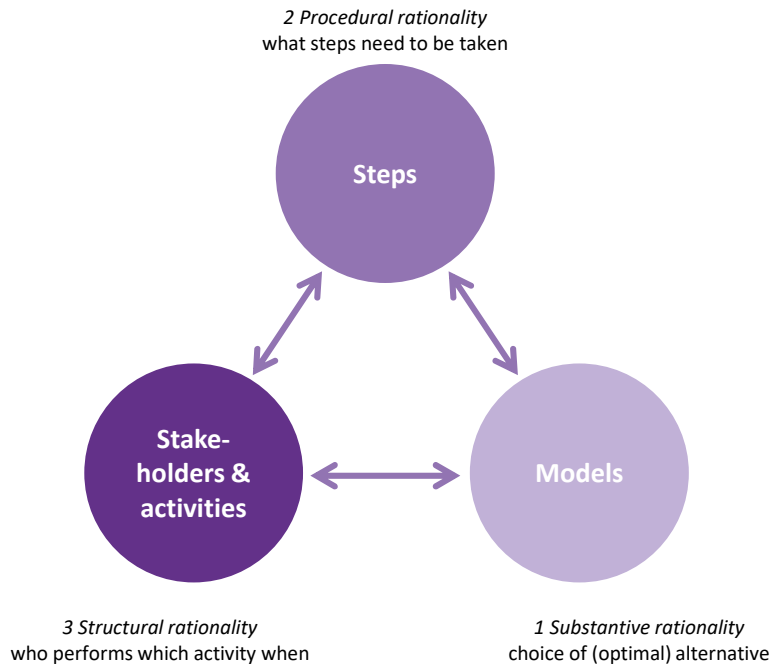

FIG. 4.1 PAS components and rationalities Note adapted from Arkesteijn et al., 2017, p. 245

“In the steps, decision makers define decision variables representing accommodation aspects and iteratively test and adjust these variables by designing new accommodations i.e. real estate portfolios. The alternative design that adds most value to the organization, i.e. has the highest overall preference, is suggested as the portfolio that optimally aligns real estate to corporate strategy. The activities that the participants perform are a series of interviews and workshops while in between the system engineer builds the accompanying mathematical models” (Arkesteijn et al.217, p. 245). The substance of the problem at hand is presented in the mathematical models, therefore although the generic part of the mathematical model as such has no substance as such. The mathematical model will enable the stakeholders to choose the best option.

4.2.3 Main development phases of PAS and its components

Due to the modular form of this thesis it is important to highlight the main development phases of PAS, its components and related publications. First of all, it is important to note that the three components as presented in the previous paragraph

are components *in* the PAS design and decision method. The PAS has been roughly developed in four development phases. This means that the phases are *not part of* the method itself. In each of the development phases the focus was slightly different as is shown in [Figure 4.2](#).

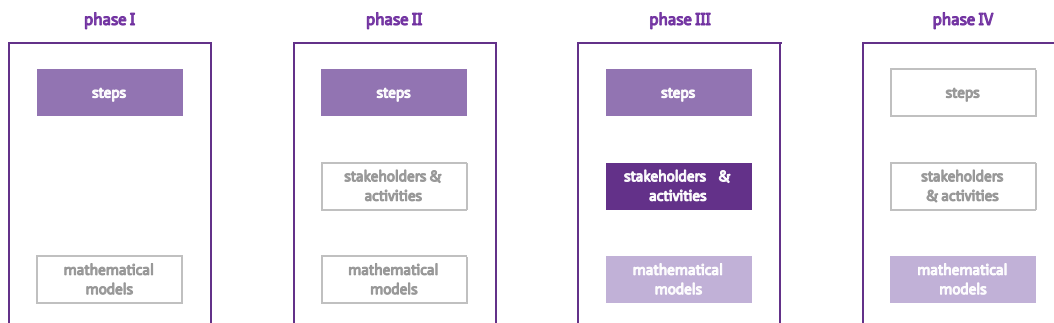

FIG. 4.2 PAS development phases and the focus on the components

In each of the development phases the focus was different (see [Figure 4.3](#)). The phases are:

First phase

In this phase the PAS steps have been developed and tested in a proof of concept. This was necessary as will be shown in paragraph 4.3 to make Binnekamp's PBD procedure applicable on CRE portfolio level. The proof of concept has been done in 2011 on the data obtained from a preliminary study at the development company of the municipality of Rotterdam.

Second phase

In this phase the PAS procedure has been further developed and tested. Amongst others, because the search algorithm as foreseen in the first development phase was not available, two PAS steps and the component stakeholders & activities were added. PAS has been tested in this phase in two pilot studies that have been conducted as part of the project 'Strategic portfolio management' at the Facility Management and Real Estate (FMRE) department of the TU Delft in the period of 2012-2013. The first pilot focused on the real estate portfolio of food facilities while the second one focused on the lecture halls. The second pilot study was published in 2015.

Third phase

In this phase PAS did not change much but in the journal paper the three equivalent components of the approach were highlighted. The publication in this phase is of the first pilot study at the TU Delft about the real estate portfolio of food facilities in 2012-2013. This first pilot study was published in 2017.

Fourth phase

In the fourth phase two optimization tools have been used to complement PAS . Firstly, a search algorithm was tested in 2014 on the data of the first pilot study food facilities. Secondly, in 2016, a third pilot study has been conducted at Oracle in which the brute force has been tested as optimization tool. The latter test was published in 2017 at the ERES conference. The brute force approach is preferable to the search algorithm as it finds a global optimum instead of a local optimum, but it cannot be used when a pilot is too complex.

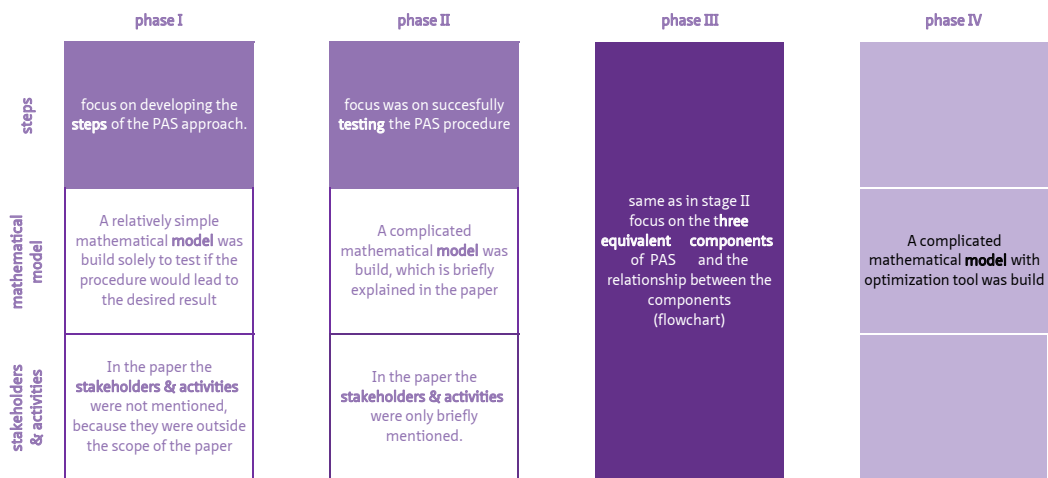

FIG. 4.3 Focus in each of the PAS development phases

Below the book and journal publications related to each phase are listed.

First phase

Arkesteijn, M. H., & Binnekamp, R. (2013). Real estate portfolio decision making. In A. V. Gheorghe, Macera, M. and Katina, P.F. (Ed.), *Infranomics: Sustainability, Engineering Design and Governance* (pp. 89-99). Dordrecht: Springer.

Second phase

Arkesteijn, M. H., Valks, B., Binnekamp, R., Barendse, P. and De Jonge, H. (2015). Designing a preference-based accommodation strategy: a pilot study at delft university of technology. *Journal of Corporate Real Estate*, 17 (2), 98-121.

Third phase

Arkesteijn, M., Binnekamp, R., & De Jonge, H. (2017). Improving decision making in CRE alignment, by using a preference-based accommodation strategy design approach. *Journal of Corporate Real Estate*, 19(4), 239-264.

Fourth phase

De Visser, H., Arkesteijn, M., Binnekamp, R., & De Graaf, R. (2017). *Improving CRE decision making at Oracle: Implementing the PAS procedure with a brute force approach*. Paper presented at the European Real Estate Society (ERES), Delft.

The link between the phases, the components, pilot studies and papers is visualized in [Figure 4.4](#).

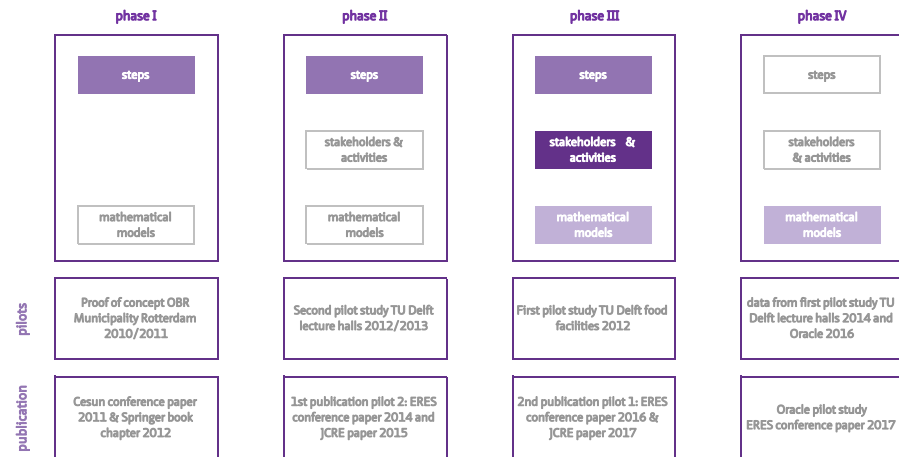

FIG. 4.4 PAS development phases, pilots and publications

4.3 PAS steps

In this paragraph the steps of PAS are presented (see [Figure 4.5](#)). The steps of PAS have been developed in multiple phases during the research project and in order to show this development process as well as the end result the first and the final version of PAS steps are presented.

- 1 The first version of the steps will be presented in paragraph 4.3.1. First, the necessity to further develop the Preference-Based Design procedure as developed by Binnekamp (2010) will be discussed and secondly the changes that have been made in the steps;
- 2 The final version is presented in paragraph 4.3.2. In this version all other changes that have been made during the development of PAS steps are addressed. First, the necessity to further develop the first version will be discussed and secondly the changes that have been made in the steps.

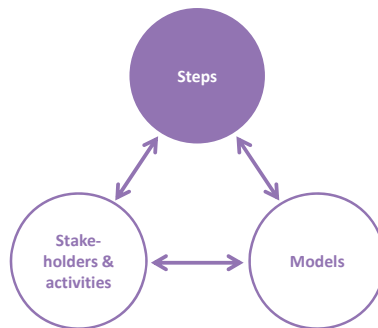

FIG. 4.5 Steps as component of PAS Note adapted from Arkesteijn et al., 2017, p. 245

4.3.1 First version of PAS steps

The first version of PAS steps³³ was developed in 2011 to enable the use of the PBD procedure on portfolio level and thereby being explicitly able to measure the added value of a new real estate portfolio in CRE alignment. These steps, or the

³³ At that time I referred to the steps as the procedure, both terms can be used interchangeably in this paragraph.

new procedure as it was referred to at that time, were called the Preference Based Portfolio Decision system (PBPD), which was later referred to as PAS procedure. The new procedure was tested as a proof of concept with data from a preliminary pilot study. The development of the PBPD proof of concept was published and in this paragraph the relevant section 'Preference Based Portfolio design' (Arkesteijn & Binnekamp, 2013, pp. 94-97) of the paper is reproduced.

In this part the first stage 'formulating the problem' of the operations research project as discussed in paragraph 4.1 for the steps is addressed.

Necessity to develop PAS procedure

"It is necessary to convert the PBD procedure in two ways in order to be able to use it on portfolio level. Firstly it is important to note that in the PBD procedure [(Binnekamp, 2010, p. 121)] each combination of decision variable values defines no more than one alternative. However, with respect to the problem of real estate portfolio decision making, one combination of decision variable values could define more than one alternative. For instance, consider a portfolio consisting of 3 buildings; building A, B and C. Assume that we are interested in the percentage of buildings that serve societal goals. Also assume that building A is the only building within the portfolio serving societal goals. This means that removing building B or C would both result in a portfolio having 50 % of buildings serving societal goals. Conversely, setting this decision variable to 50 would define two alternatives (portfolio with building A and B and the portfolio with buildings A and C), not just one. To resolve this problem all possible portfolios need to be generated using the number of buildings in the current portfolio and the number of allowed interventions. Given i interventions and j buildings a total of i to the power of j combinations are possible. In this experiment the portfolio consists of 15 buildings and 3 interventions (remove, keep, renovate) are considered. A building can be removed from the portfolio for instance if it is demolished or sold. The total number of possible portfolios is the number of interventions to the power of the number of buildings ($3^{15} = 14,348,907$).

Secondly, approaching the generation of portfolios this way means that the performance of each portfolio is determined a posteriori. Going back to the previous example, removing building B is an example of a generated portfolio. Only after this portfolio has been generated it is possible to determine the number of buildings that serve societal goals with respect to the total number of buildings within that particular portfolio consisting of buildings A and C. However, within the original PBD procedure, the Bezier curve was divided in segments yielding a number of points on each curve. The x-coordinates of these points represented the performance of the alternative with respect to that design variable a priori.

As a result, it is no longer useful to divide the curve in segments to generate a set of points. Instead, the preference rating needs to be a function of the design variable value. This means that it is not possible to use a Bezier curve because this is a parametric equation. Instead, the decision maker needs to define 3 points relating decision variable values to preference ratings. The Lagrange curve defined by these points can then be found by means of curve fitting.” Arkesteijn and Binnekamp (2013, pp. 94-95).

In the next part, Ackoff's second stage 'constructing the model' of the operations research project as discussed in paragraph 4.1 for the steps is addressed.

“The above changes mean that steps 2 and 5 of the original PBD procedure (see paragraph 3.1.13) have been changed as follows:

- 1 Specify the decision variable(s) the decision maker is interested in;
- 2 Rate the decision maker's preferences for each decision variable by fitting a curve through three decision variable value / preference rating coordinates as follows:
 - a Establish (synthetic) reference alternatives which define 2 points of the curve:
 - Define a 'bottom' reference alternative, the alternative associated with the value for the decision variable that is least preferred, rated at 0. This defines the first point of the curve, (x_0, y_0) ;
 - Define a 'top' reference alternative, the alternative associated with the value for the decision variable that is most preferred, rated at 100. This defines the second point of the curve, (x_1, y_1) ;
 - b Rate the preference for an alternative associated with an intermediate decision variable value relative to the reference alternatives. This defines the third point of the curve (x_2, y_2) ;
- 3 To each decision variable assign decision maker's weight;
- 4 Determine the design constraints;
- 5 Generate all design alternatives (using the number of buildings and allowed interventions). Then use the design constraints to test their feasibility;
- 6 Use the PFM algorithm to yield an overall preference score of all feasible alternatives.” Arkesteijn and Binnekamp (2013, p. 95)

The preference curves can take different forms; some examples are given in [Figure 4.6](#). The 'curve' can take the form of a straight line, a concave or convex form or a parabola.

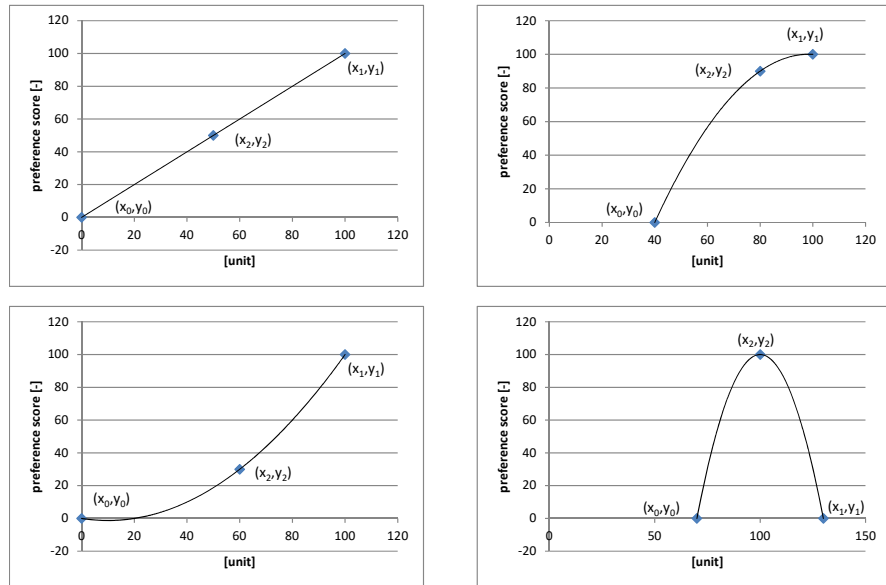

FIG. 4.6 Examples of preference curves

Proof of concept PAS steps

In the next part the third stage ‘deriving a solution’ of the operations research project as discussed in paragraph 4.1 for the steps is addressed. “In order to evaluate this new PAS procedure a case simulation is generated based on the prototype Public Real Estate system for the municipality of Rotterdam.

Step 1: Specifying the decision variable(s)

The following six decision variables for the specified stakeholders within this municipality are used. (1) Policymaker: the percentage of buildings within the (new) portfolio serving societal goals. (2) Policymaker: the percentage of buildings within the (new) portfolio having an overall preference rating of 40 or more on the criterion ‘user satisfaction’³⁴. (3) Technical manager: the percentage of buildings within the (new) portfolio having an overall preference rating of 40 or more on the criterion ‘technical state’. (4) Asset manager The percentage of buildings within the (new)

³⁴ Note that within this procedure preference is rated at an object and portfolio level. For example, ‘user satisfaction’ is rated on object level. The percentage of buildings within the (new) portfolio having an overall preference rating of 40 or more on the criterion ‘user satisfaction’ is rated on a portfolio level.

portfolio for which the rent covers the cost. (5) Users: The gross floor area of the (new) portfolio and (6) Policymakers: The additional yearly rent due to renovation.

Step 2: the decision maker's preferences for each decision variable

Table 4.4 shows for each decision variable value the 3 points that relate decision variable values to preference ratings. These 3 points define a Lagrange curve (**Figure 4.7**). [Note this can be related to object level or to portfolio level].

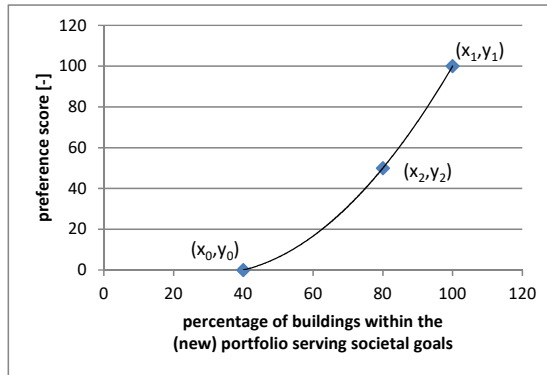

FIG. 4.7 Lagrange curve relating preference rating to percentage of buildings within the portfolio serving societal goals Note adapted from Arkesteijn & Binnekamp, 2013, p. 96

TABLE 4.4 Decision variables and associated decision maker's preference ratings Note adapted from Arkesteijn & Binnekamp, 2013, p. 96

Decision variables		Bottom reference (x_0, y_0)	Top reference (x_1, y_1)	Intermediate reference (x_2, y_2)
1	Percentage of buildings serving societal goals	100,100	40,0	80,50
2	Percentage of buildings scoring ≥ 40 on user satisfaction	100,100	0,0	50,70
3	Percentage of buildings scoring ≥ 40 on technical state	100,100	20,0	50,60
4	Percentage of buildings for which rent covers costs	100,100	0,0	50,60
5	Gross floor area	1628,0	1794,0	1709,100
6	Additional yearly rent due to renovation interventions	60k,0	0,100	30k,40

Step 3: Assigning decision maker's weight to each decision variable

Table 4.5 shows for each decision variable value the weight assigned by the associated decision maker.

TABLE 4.5 Decision variables and assigned decision maker's weights Note from Arkesteijn & Binnekamp, 2013, p. 97

Decision variables		weights
1	Percentage of buildings serving societal goals	10
2	Percentage of buildings scoring ≥ 40 on user satisfaction	10
3	Percentage of buildings scoring ≥ 40 on technical state	10
4	Percentage of buildings for which rent covers costs	10
5	Gross floor area	40
6	Additional yearly rent due to renovation interventions	20

Step 4: Determining the design constraints

For this experiment no design constraints are used.

Step 5: Generating all design alternatives

In this experiment the portfolio consists of 15 buildings and 3 interventions (remove, keep, and renovate). Of each building information relating to each decision variable is known. No design constraints are used, this means all design alternatives are considered feasible." Arkesteijn and Binnekamp (2013, pp. 95-97).

Step 6: Using the PFM algorithm to yield an overall preference scale

Table 4.6 shows the current portfolio and the portfolio '9388514' which has the highest preference ratings. In the first row all fifteen buildings of the portfolio are shown. The current portfolio is shown at the bottom. As can be seen each of the buildings has an intervention 1 which means the building will stay in the portfolio but no changes will be made. The overall preference rating of the current portfolio (keep all buildings) is 17.7. In portfolio '9388514' building 14 will be removed from the portfolio (intervention 0). Four buildings (numbers 1, 4, 10 and 12) will stay the same (intervention 1) the remaining buildings (numbers 2, 3, 5, 6, 7, 8, 9, 11, 13 and 15) will be renovated (intervention 2). In this case the highest rated portfolio '9388514' has an overall preference rating of 75,6 and thereby shows a possible overall performance improvement of 57.9.

TABLE 4.6 Current portfolio and portfolio with highest overall preference score (Legend interventions 0=remove, 1=keep, 2=renovate) Note adapted from Arkesteijn & Binnekamp, 2013, p. 97

Portfolio	1	2	3	4	5	6	7	8	9	10	11	12	13	14	15	Rating
9388514	1	2	2	1	2	2	2	2	2	1	2	1	2	0	2	75.6
Current	1	1	1	1	1	1	1	1	1	1	1	1	1	1	1	17.7

In the next part, the fourth stage ‘Testing the model and evaluating the solution’ of the operations research project as discussed in paragraph 4.1 for the steps is addressed.

“The proposed PBPD procedure can be used at portfolio level because the two before mentioned limitations are removed. However, the use of the Lagrange curves which oscillate between their roots (knots) could create a problem a problem because they can take negative preference values. This problem is dealt with by directly visually feeding back the Lagrange curve defined by the points.

In this experiment the total number of possible portfolios is the number of interventions to the power of the number of buildings ($3^{15}=14,348,907$). If a portfolio consist of more buildings and more interventions will be considered, as is usually the case, the computer time needed to generate and evaluate all possible portfolios giving rise to the need for a search algorithm.

Despite these limitations, we see the proposed PBPD procedure and associated model as a proof of concept for applying it in practice” Arkesteijn and Binnekamp (2013, pp. 97-98).

4.3.2 Final version of PAS steps

During the development and the use of PAS most steps have been changed, either profoundly or only textually. In this subparagraph the final version of the steps are presented. Note this is after the use and evaluation of PAS , which will be presented in part II of this thesis.

In the development of steps (first version) it was foreseen that if a portfolio consist of more buildings and more interventions it would not be possible to generate all possible CRE portfolios in step 5 of the procedure. The solution for this problem was to devise a search algorithm. This search algorithm however, was not available at the time of the first two pilot studies.

Furthermore, in chapter 2, I concluded that the model needed to fulfill certain requirements. The stakeholders needed to be able to formulate well defined criteria and iteratively make/create/design alternative CRE portfolios. In the DAS frame, as presented in chapter 2, the iterative nature of the model is one of its key characteristics which needs to be incorporated in PAS procedure. Since in CREM it is common to have conflicting interest between the stakeholders, the stakeholders define their demand and subsequently need to see the effect of their requirements on possible solutions before finalizing their requirements. This enables the stakeholders to get what they want and at the same time understand what they want. It is assumed that this iteration between demand (requirements) and supply (CRE portfolio) would enhance the acceptance of the results by the stakeholders. The stakeholders, as explained in chapter 3, are seen as decision makers on the one hand and designers on the other hand. This means that in step 5 of PAS the stakeholders needed to be able to design alternative portfolios next to the computer generated alternatives with an optimization tool.

During the use of PAS most of the steps were slightly adjusted and step 3 was changed. All steps were adjusted textually to formulate the steps from the perspective of the decision maker. Step 3 was adjusted to explicitly make it possible that multiple decision makers are able to use the procedure. The first version of PAS procedure was formulated for one decision maker while more decision makers were implicitly already foreseen. Although not formulated in the procedure, multiple stakeholders were part of the proof of concept as reported in the former paragraph (Arkesteijn and Binnekamp, 2013, p. 98). This has one other implication for the procedure as well. The weights between the decision variables of a certain decision maker are determined in step 3. However, the weights between decision makers were only implicitly part of the procedure (Arkesteijn and Binnekamp, 2013, p. 96). The implication therefore is to add to step 3 that the subject owner assigns the weights between the decision makers.

The final version³⁵ of the steps of PAS is:

- 1 Each decision maker specifies the decision variable(s) they are interested in;
- 2 Each decision maker rates their preferences for each decision variable by fitting a curve through three decision variable value / preference score coordinates as follows:
 - a The decision maker establishes (synthetic) reference alternatives which define 2 points on a Lagrange curve:
 - A 'bottom' reference alternative is defined, which is the alternative associated with the value for the decision variable that is least preferred, rated at 0. This defines the first point of the curve, (x_0, y_0) ;
 - A 'top' reference alternative is defined, which is the alternative associated with the value for the decision variable that is most preferred, rated at 100. This defines the second point of the curve, (x_1, y_1) ;
 - b The decision maker rates the preference for an alternative associated with an intermediate decision variable value relative to the 'bottom' and 'top' reference alternatives. This defines the third point of the curve (x_2, y_2) ;
- 3 Each decision maker assigns weights to their decision variables. The subject owner assigns weights to each decision maker;
- 4 Each decision maker determines the design constraint(s) they are interested in;
- 5 Design alternatives are generated in parallel by:
 - a The decision makers who group wise design alternatives and use the design constraints to test the feasibility of the design alternatives and use the PFM algorithm to yield an overall preference score of these feasible design alternatives.
 - b The system engineer generates feasible design alternatives and uses the PFM algorithm to find the feasible design alternative with the highest overall preference score;
- 6 The decision makers select the design alternative with the highest overall preference score either generated by the decision makers or the system engineer.

³⁵ This final version of the steps differs from the steps that has been published in Arkesteijn et al., 2014, Arkesteijn et al., 2017. In this version the singular they is used for gender neutrality as explained in the introduction.

In order to develop the PAS steps, the stages of Ackoff and Sasieni (1968, p. 11) have been used several times. The major changes between the first and final version have been summarized in [Table 4.7](#).

TABLE 4.7 Stages used in developing PAS steps

Stages	First version	Final version
1 st Formulating the problem	The Preference-Based design procedure of Binnekamp cannot be used on portfolio level	The steps in the 1 st version assumed that all possible portfolios could be generated. As a solution a search algorithm was foreseen, this algorithm was not available at the time of testing the procedure. The steps did not enable stakeholders to design alternative portfolios themselves. The steps also did not allow the responsible management to assign weights between the decision makers (stakeholders).
2 nd Constructing the model	Steps 2 and 5 of the procedure have been altered	Step 3 and 5 of the procedure have been altered. And textual changes have been made to all steps to formulate them from the decision makers perspective.
3 rd Deriving a solution	A proof of concept has been made and a solution could be found	this version of the steps is tested in three pilots (see chapter 5 to 8)
4 th Testing the model and evaluating the solution	The solution works; two problems can be foreseen in the future (Lagrange curves ad amount of alternative solutions)	

4.4 Stakeholders and activities in PAS

The second component of PAS is stakeholders & activities (see [Figure 4.8](#)).

In paragraph 4.4.1, firstly all relevant stakeholders in PAS are described and in paragraph 4.4.2 the activities that the stakeholders need to perform to be able to iteratively perform the steps that have been given.

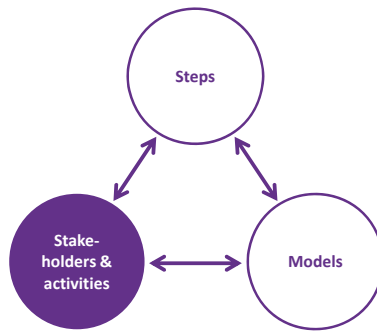

FIG. 4.8 Stakeholders & activities as component of PAS
 Note adapted from Arkesteijn et al., 2017, p. 245

4.4.1 Relevant stakeholders for PAS

In this paragraph it will be shown that PAS is seen as an inter-actor approach and that three groups play a principal role in PAS. These are the responsible management, the stakeholders, and the systems engineer. After their introduction, the group stakeholders is further elaborated upon.

PAS is an inter-actor approach

PAS is an inter-actor approach as explained in chapter 3. The approach is referred to as inter-actor approach because it is possible to include actors outside of the own organization as well. However, the primary actors come from the same corporation (also referred to as organization). Therefore, it is very likely that there is a hierarchic relation between actors. This relationship normally would be referred to as multi-actor instead of inter-actor. Because in PAS the actors are not limited to the own organization, the approach is called an inter-actor instead of a multi-actor approach.

Three groups involved are involved in PAS

In PAS three main types of groups are involved; responsible management, stakeholders, and the systems engineer. In publications of the PAS, these groups have been referred to in different ways. At the same time, in different scientific domains these groups have different names. In business management, De Leeuw (2002, p. 281) distinguishes (1) the stakeholders, (2) the responsible management and (3) the managerial problem solver in his role as professional researcher and/or advisor. He visualizes this as a triangle around reality and states that managerial problem solving takes part in this arena. In design engineering, Dym and Little

(2004, p. 2) refer to the designer-client-user triangle, indicating the three parties involved in a design effort. 'The client, who has the objective that the designer must clarify; the user of the designed device, who has his own requirements; and the designer, who must develop specifications such that something can be built to satisfy everybody'. In **Table 4.8** the different names for these groups are shown with the preferred terminology in the first column.

In this thesis, each of the groups involved plays a different role. The responsible manager in the organization, sometimes in conjunction with the responsible real estate manager, selects the different types stakeholders who will be involved in the project. These are called relevant stakeholders. During a project the selected relevant stakeholders also have the opportunity to add other stakeholders to the project. It should be noted here that the responsible manager and real estate manager next to their role as responsible management also can be relevant stakeholder. The facilitator leads and facilitates the process while the system engineer builds the mathematical models. Sometimes one person fulfills both roles.

TABLE 4.8 Terminology of relevant groups

Preferred terminology	PAS (published papers)	Management (De Leeuw)	Design engineering (Dym and Little)
Responsible management	Subject owner	Responsible management	Client
Decision makers or stakeholders	Different terms are used: mostly decision makers and/or stakeholders but also sometimes users, participants,	Stakeholders	User
Facilitator & system engineer	System engineer	Managerial problem solver, advisor, researcher	Designer

Selecting relevant stakeholders

When selecting relevant stakeholders for the project, it is important, according to Den Heijer, to involve representatives of four stakeholder perspectives (see **Figure 4.9**) in the decision making process, so as to incorporate all relevant information and add value in the broadest sense (Den Heijer, 2011, p. 108). In the pilot studies this model has been used as reference to select relevant stakeholders. As can be seen, each perspective has his own icon and color. In the remainder of this thesis, when in tables or figures the stakeholders are mentioned, these colors and icons are used so that they can be easily visually recognized.

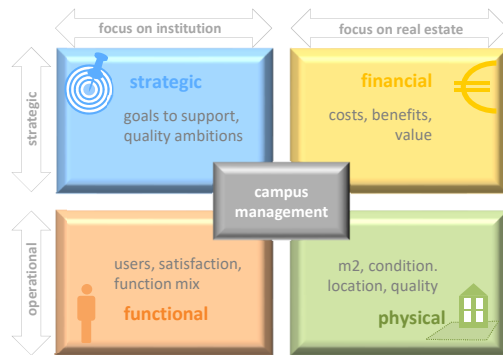

FIG. 4.9 CREM model Note from Den Heijer, 2011, p. 106

In this thesis stakeholders are viewed as the decision makers. As explained in paragraph 3.2, preference measurement, preferences always belong to a specific stakeholder. This means that in PAS each decision maker is responsible for their own criteria (step 1), preferences (step 2), weights (step 3) and design constraints (step 4). In step 6 the alternative with highest overall preference is the preferred alternative, i.e. chosen alternative. This means that the stakeholders and their preferences logically determine the chosen solution. Therefore we refer to them as the decision makers.

Viewing stakeholders as decision makers is different from most CRE alignment approaches, where it is not exactly clear who does what, when and how. In these approaches the focus is on what needs to be done i.e. steps. This is also different from other types of problem solving approaches, where often consensus is sought in the program of requirements (defining the criteria) before designing solutions. In PAS, each stakeholder remains responsible for his requirements (step 1 to 4) and consensus is sought in the solution, i.e. the alternative CRE portfolio (step 5 and 6).

Note: When referring to user(s) in the published paper the word user has been used in two different ways. On the one hand it referred to the user as indicated in the abovementioned CREM model and on the other hand to 'users' of this particular design approach and of course more specific, of the mathematical model. In hindsight for the latter meaning another term would have been more appropriate. Next to this in CRE management the word 'user' also causes confusion, because in this field the word both 'users' and 'end users' are commonly used. User mostly refers to the actual users of the space. However, sometimes the actual user of the space is referred to as end user. Mostly when people use the term end user, they refer to the whole end user organization, as does Den Heijer. However, as mentioned there are also authors that use the terms oppositely.

4.4.2 PAS activities³⁶

In order to perform the steps of PAS in an iterative way the stakeholders needed to perform several activities. The activities consisted of interviews and workshops. The interviews were used to set the requirements which is done in steps 1 to 4 of PAS procedure and the workshops were used to design alternative CRE portfolios which is done in step 5 while the selection of the best alternative is done in step 6.

Interviews

- 1 Specifying decision variable(s);
- 2 Determining the decision maker's preference to each variable;
- 3 Assigning the decision maker's relative weight to each variable;
- 4 Determining the design constraints;

Workshops

- 1 Generating design alternatives;
- 2 Selecting the best alternative.

There is a feedback loop present from step 5 to step 1 to 4, i.e. to be able to perform the steps in an iterative way, so that, if the stakeholders do not accept the best design alternative, the model could be adjusted in accordance with the results in the intermediate steps. In order to facilitate this iteration, the interviews and workshops are completed a number of times in a sequence. This sequence can be performed more times if necessary. This process will be as follows:

- Interview 1;
- Workshop 1;
- Interview 2;
- Workshop 2;
- Interview 3.

The cyclical process of interviews and workshops allows the facilitator and system engineer to continuously adapt and improve the computer model, thereby providing a better reflection of the stakeholders' preferences. A better reflection equals a

³⁶ The stakeholder selection and the activities have been developed for the first pilot food facilities at the TU Delft by the author. However, the activities have first been reported in the graduation thesis Valks (2013) with reference to the first pilot. Therefore, this text is almost similar to that in the graduation with small adjustments, based on the further development of PAS and the terminology that has been used.

better representation of reality. It also gives stakeholders the opportunity to adapt their decision variables and design new alternatives based on the insights that they gain during the process. In each PAS project two three hour workshops were scheduled and three one hour interviews per stakeholder.

Each interview and workshop will be discussed.

Interview 1

At the start of the first interview, the interviewee is introduced to PAS , the specific purpose of the project is and what is required of the stakeholder during the process. The objective of the interview is perform step 1 to 4 and determine his/her input for the mathematical model.

The stakeholders are asked to define the relevant criteria for them. They do this by first looking at the current problems in the CRE portfolio, secondly by indicating the objectives that they strive for with this particular real estate type and subsequently translating them into criteria. It is explicitly stated that they are free to determine whichever decision variables they wish to incorporate, and they are allowed to modify their decision variables, preferences and weights later in the process. The objective is completed if the required information for step 1 to 4 is collected. In [Table 4.9](#) the interview questions of the first interview are displayed. Each stakeholder receives a log of their input before the first workshop in which their answers are recorded.

TABLE 4.9 Questions in interview 1

Steps		Interview questions	
1	Specifying decision variable(s)	1.1	What are the current problems with [add the specific CRE portfolio]?
		1.2	What are the objectives that you wishes to achieve ?
		1,3	What decision variables reflect that objective?
2	Rating preferences	2.1	Assign a preference score of 100 to your most desired outcome
		2.2	Assign a preference score of 0 to your least desired outcome
		2.3	Assign a preference score between 0 and 100 to an intermediate outcome
3	Assigning weights	3.1	What are the relative weights between your decision variables?
4	Determining design constraints	4.1	What design constraints must be met?

Workshop 1

At the start of the first workshop, the facilitator repeats the specific purpose of the project, introduces the diary for the workshop and all stakeholders are introduced to each other. The facilitator shows the model to the stakeholders to give them a basic understanding of the model. The two main objectives of the first workshop are that the stakeholders (1) become familiar with the depiction of the problem in the computer model and (2) are able to use the computer model to design alternatives in order to gain insights in their own input as given in the first interview. It should be noted, that most stakeholders probably are not used to translating these objectives into concrete criteria on the one hand and never have been asked to define their own 'measuring scale' by rating their preferences according to step 2. In general, the stakeholders are divided in smaller subgroups and asked to perform a number of assignments.

Interview 2

Based on their experiences in workshop 1, in this round of interviews each stakeholder is allowed to adjust their variables, preferences, and weights and add new decision variables. The following interview questions are asked (see [Table 4.10](#)).

TABLE 4.10 Questions in interview 2

Steps		Interview questions/tasks	
1	Specifying decision variable(s)	1.1	Adjust and/or specify (additional) decision variable(s)
2	Rating preferences	2.1	Adjust and/or rate preferences (see 2.1 to 2.3 interview 1)
3	Assigning weights	3.1	Adjust and/or assign weights
4	Determining design constraints	4.1	Adjust and/or determine design constraints
Steps		Interview questions/tasks	
1	Specifying decision variable(s)	1.1	Adjust and/or specify (additional) decision variable(s)
2	Rating preferences	2.1	Adjust and/or rate preferences (see 2.1 to 2.3 interview 1)
3	Assigning weights	3.1	Adjust and/or assign weights
4	Determining design constraints	4.1	Adjust and/or determine design constraints

Workshop 2

In this workshop the decision makers continue designing alternatives to reach an optimal result together as a group (see [Table 4.11](#)). The decision makers have an adjusted mathematical model available based on the adjusted input in the second round of interviews with each of the stakeholders. The difference compared to the first workshop is that in this workshop, the stakeholders are already acquainted with the PAS model. In this workshop the stakeholders work together rather than individually. The focus shifts from understanding the model and adjusting the input towards designing alternatives and accepting the results as generated by the model.

TABLE 4.11 Assignments in workshop 2

Steps		Assignment	
5	Generating design alternatives	5.1	Design an alternative CRE portfolio with a higher overall preference score than the current portfolio taking into account the demands of all stakeholders
6	Selecting best design alternative	6.1	Select the alternative CRE portfolio with the highest overall preference score

In workshop 2 the sequence of assignments is the following :

- The stakeholders are split up into two groups. Both groups focus on designing an alternative reaching the highest preference score;
- The groups come together and discuss their findings, after which a combination is sought between the two alternatives in order to reach the alternative with the highest preference score.

Interview 3

In the third series of interviews, the decision makers are individually asked to confirm the selection of the best design alternative from the previous workshop. If all stakeholders individually accept this alternative the project is ended. However, if one or more stakeholders do not accept that alternative (with the highest overall preference score) as the best alternative this means that the empirical system has not been mapped correctly. If it would have been mapped correctly, all stakeholders would accept the outcome. Logically it follows that one of the stakeholders then needs to change the input in such a way that it better reflects their preferences. In that case, the exact same procedure is carried out as in the second series of interviews and the second workshop. If necessary, the cycle can be extended by repeating the interviews and workshop until a satisfactory result is reached, i.e. until all stakeholders confirm the alternative with the highest overall preference.

4.5 PAS generic mathematical models

In this paragraph PAS models are presented (see [Figure 4.10](#)).

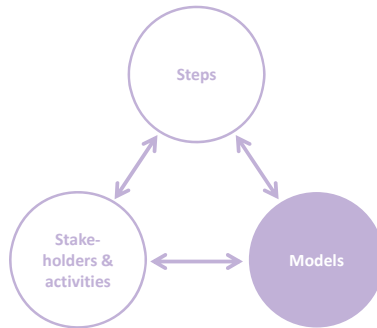

FIG. 4.10 Models as component of PAS Note adapted from Arkesteijn et al., 2017, p. 245

The objective of the mathematical model is to calculate the overall preference rating, i.e. *value* of an alternative real estate portfolio (future supply). In order to also determine the added value of this alternative real estate portfolio it is also necessary to calculate the overall preference rating of the current real estate portfolio. In this dissertation the added value of a real estate portfolio is defined as the difference between the overall preference score of the alternative real estate portfolio and the current real estate portfolio.

In paragraph 4.5.1 the principal formulas that are needed to calculate the overall preference score of any alternative are given. Secondly, in paragraph 4.5.2 the generic structure of the model is visualized. In paragraph 4.3 it was explained that alternative CRE portfolios can be generated in different ways. They can be designed by the stakeholders on the one hand and they can be computer-generated by an optimization tool. In paragraph 4.5.3 two different optimization tools are discussed.

4.5.1 Principal formulas of the mathematical model

The mathematical model starts with the input of an (any) alternative and therefore is independent of the way an alternative is generated.

The overall preference score is calculated using three generic formulas;

- 1 To convert the decision variable value into a preference score per decision variable;
- 2 To calculate the overall preference score per stakeholder;
- 3 To calculate the overall preference score for the alternative is calculated by aggregating all stakeholders' preference scores.

An alternative and decision variable value per decision variable as input

An alternative is in described as follows:

The state vector is an alternative in the form (x_1, \dots, x_{16}) where x_j is the state of an object j .

If the state vector is known, the decision variable value per decision variable can be obtained from the dataset. The decision variables will be specific for each pilot.

Preference score per decision variable per stakeholder

The decision makers define three points that relate decision variable values to preference ratings. A Lagrange curve³⁷ is then fitted through these three points ($n=3$). Because this curve is continuous this means that for any value of a decision variable value the preference rating can be found on the curve. Binnekamp (2010, pp. 101-102):

The Lagrange curve is a polynomial $P(x)$ of degree $\leq (n - 1)$ that passes through n points $[x_1, y_1 = f(x_1)]$, $[x_2, y_2 = f(x_2)]$, $[x_n, y_n = f(x_n)]$

Lagrange formula, returning a value between 0 and 100 .

$$P(x) = \text{Min}(100, \text{Max}\left(0, \left(\frac{(x-x_1)(x-x_2)}{(x_0-x_1)(x_0-x_2)}\right) * y_0 + \left(\frac{(x-x_0)(x-x_2)}{(x_1-x_0)(x_1-x_2)}\right) * y_1 + \left(\frac{(x-x_0)(x-x_1)}{(x_2-x_0)(x_2-x_1)}\right) * y_2\right))$$

³⁷ It is possible that a stakeholder determines the points such that the line is straight.

The function $Min(a, b)$ returns the minimum value of the value a and b .

The function $Max(a, b)$ returns the maximum value of the value a and b .

It is possible that different stakeholders have defined the exact same decision variable and unit, but have determined different points. This means that although the decision variable value is the same, the preference score is different.

Overall preference score per stakeholder

Overall preference score for stakeholder k for alternative i :

$$O_{ik} = \sum_{j=1}^n w_{jk} \cdot P_{ij}$$

Where:

- n number of criteria;
- i index of alternative i ;
- j index of criterion j ;
- k index of stakeholder k ;
- w_{jk} weight of criterion j by stakeholder k .
- O_{ik} overall preference score of alternative i by stakeholder k .
- P_{ij} preference of alternative i for criterion j .

Overall preference score

Overall preference of all stakeholders k for alternative i :

$$T_i = \sum_{k=1}^p s_k \cdot \sum_{j=1}^n w_{jk} \cdot P_{ij}$$

$$T_i = \sum_{k=1}^p s_k \cdot O_{ik}$$

Where:

- p number of stakeholders;
- s_k weight of stakeholder k ;
- T_i overall preference score of alternative i by all stakeholders.

4.5.2 Basic structure of the mathematical model

The basic structure of the mathematical model is visualized in **Figure 4.11**.

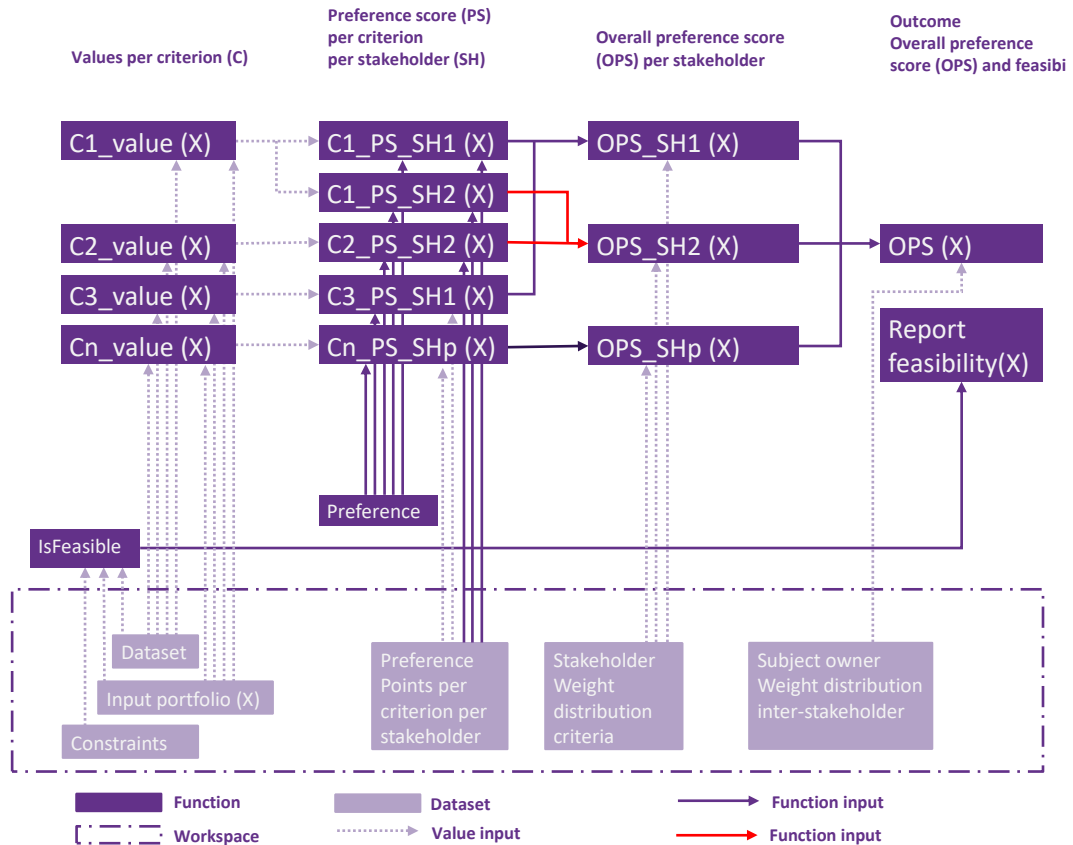

FIG. 4.11 Visualization generic mathematical PAS model Note based on de Visser 2016, p. 70

4.5.3 Two techniques to generate the optimal alternative

In the fourth stage of the development of PAS, as explained in paragraph 4.2, two optimization tools have been used. This is done to be able to select the optimal alternative, i.e. the alternative with the highest overall preference score. In the

previous paragraph it is explained that the stakeholders design alternatives and that the alternative with the highest overall preference score is chosen. However, although this is the best alternative that can be designed, and thus is satisficing, it is not sure if another alternative exists with a higher overall preference score.

In paragraph 4.3.1, all alternatives were generated in the proof of concept. In more complicated real life pilots it is likely that the number of alternatives will be so large that generating and evaluating these will consume too much computer time . In this research two optimization tools will be tested. Firstly, a search algorithm will be tested and secondly, a brute force approach. Both will be explained in general in this paragraph.

Search algorithm

A search optimum finds a *local optimum*. A *local optimum* is a solution that is better than any other feasible solutions in its immediate, or local, vicinity (Ragsdale, 2008, p. 342), However, a given local optimal solution may not be the best possible solution, or *global optimum*, to a problem (see [Figure 4.12](#)). A search algorithm can be used in situations with a large number of alternatives.

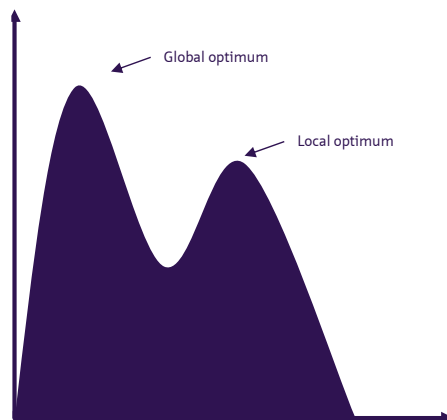

FIG. 4.12 Visualization global and local optimum

Brute force

If a pilot is not too complex, it is possible to generate all alternatives with a brute force approach. In computer science, brute-force search or exhaustive search, also known as generate and test, is a very general problem-solving technique and algorithmic paradigm that consists of systematically enumerating all possible

candidates for the solution and checking whether each candidate satisfies the problem's statement (Wikipedia, n.d.). A brute-force search is used when the problem size is limited. If a problem is complex (see paragraph 3.1.12) and cannot be used if the combinatorics cause an explosion of alternatives. After all alternatives have been generated they are ordered on overall preference score, similar as has been done in the example in paragraph 4.3.1. This means that the global optimum can be determined.

4.6 Conclusion and coherence between three PAS components

PAS is developed using the fifteen basic concepts and definitions from chapter 3. All three rationalities are used to open the black-box of decision making and structure PAS to achieve CRE alignment. The three PAS components are the steps (procedural rationality), the stakeholders & activities (structural rationality) and the mathematical model (substantive rationality). For PAS to be operational all components need to be connected coherently. The coherence between the components is shown in the flowchart (see [Figure 4.13](#)).

The three components in the flowchart each have their shade of purple (as in [Figure 4.13](#)). The stakeholders & activities are displayed in the first four columns (dark purple), the steps are given in the intermediate columns (purple while the model building is presented in the last column (light purple).

Following the flowchart, it is explained which activity is performed by whom and which steps are done in that particular activity. Following the arrows in the flowchart it shows how the information of one step is input for the next step. The flowchart stops in the last interview if each stakeholder individually accepts the alternative with the highest overall preference score as the selected alternative. If one of the stakeholders does not accept this alternative this means that (part of) their input does not reflect their preferences correctly and needs to be adapted accordingly. The adapted input is goes back to model building (n) and the continues in the flowchart represented until all stakeholders accept the best alternative.

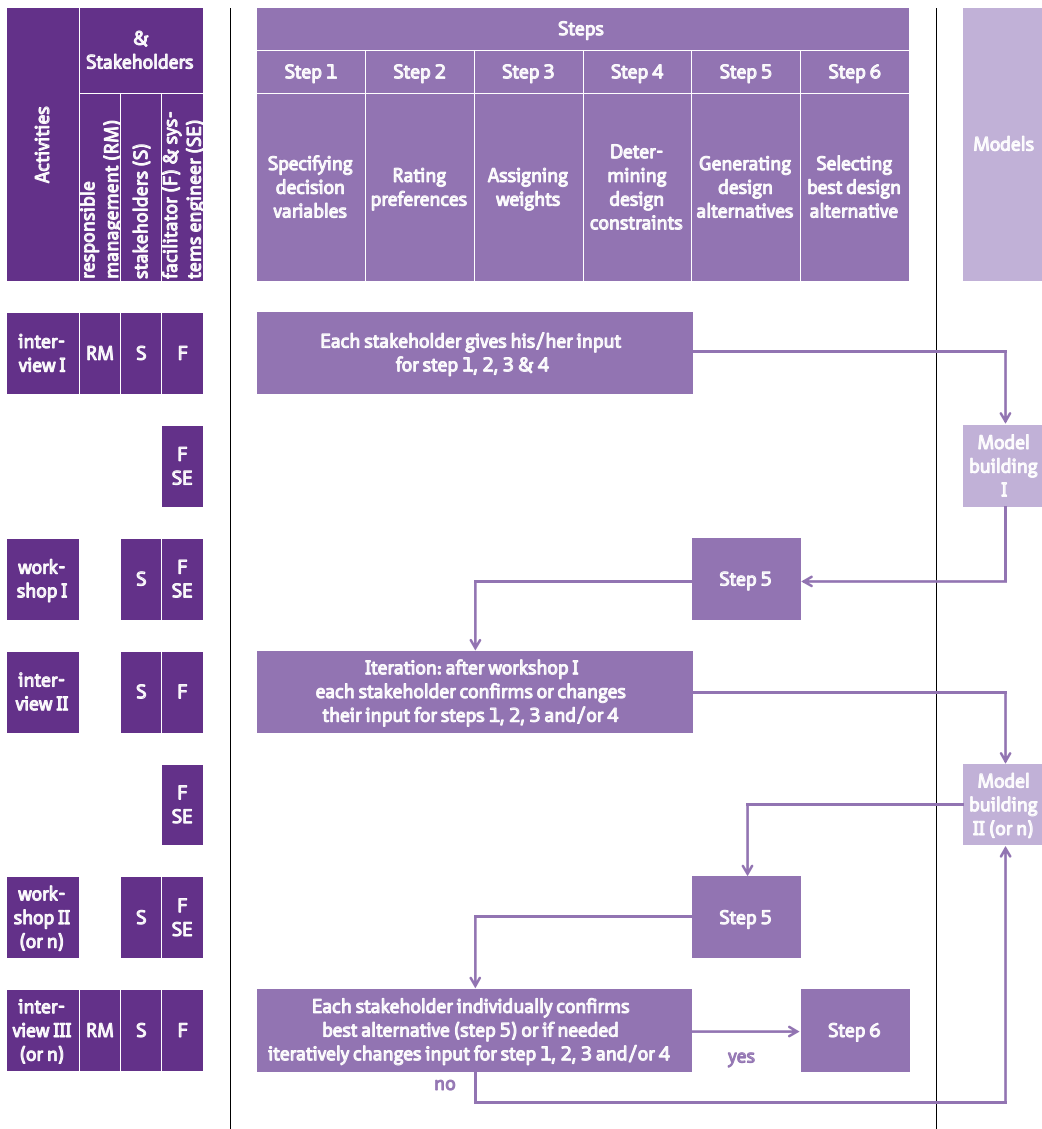

FIG. 4.13 PAS Flowchart Note adapted from Arksteijn et al., 2017, p. 248

Reflection to the requirements (chapter 2)

The developed PAS approach fulfills all requirements as presented in chapter 2 that are logically needed to enable CRE managers to measure the added value in their CRE alignment process. For each of the characteristics/requirements this is done as follows.

Formulating demand

The PAS approach is *integral* because all relevant stakeholders can be involved and are able to specify all types of requirements (qualitative and quantitative). The approach is *explicit* because their CRE accommodation strategy is stated in objectives and/or related problems and expressed in well-defined operational criteria. The approach is also *personal* because each criterion is established by a specific stakeholder and is linked to this stakeholder during the whole process.

Designing alternatives

The PAS approach enables the stakeholders to *design* alternative CRE portfolios (future supply) themselves in the mathematical model. The approach is *iterative* by having a feedback loop after the potentially last interview, but first of all by having an active interplay between demand (step 1 to 4 in the interviews) and supply (step 5 in the workshops) that enable the stakeholders to state what they want, but also to understand what that means when projected onto the CRE portfolio. If their demands were not correctly understood or thought through the system engineer is able to adjust the model or the stakeholders to adjust their input. The PAS approach is able to determine the CRE portfolio with the *optimal* added value because next to the design which produces an alternative real estate portfolio with the highest overall preference, an optimization tool is able to search the portfolio of feasible alternatives for another alternative with potentially a higher overall preference score.

Selecting an alternative

The PAS approach is able to *indisputable* determine the best alternative because the performance of an alternative because the individual criteria are aggregated into one overall performance rating, the overall preference score. The approach is *correct* because it ensures that if scales are used to measure so-called qualitative requirements (non-physical properties) strong scales (Barzilai, 2010) are used.

5 PAS steps to achieve alignment

chapter 2	CRE alignment state of the art and scientific gap
-----------	---

Preference-based Accommodation Strategy (PAS)
design and decision approach

Developing PAS		Testing PAS			Evaluating PAS
chapter 3	chapter 4	chapter 5	chapter 6	chapter 7	chapter 8
fifteen basic concepts and definitions from decision, design and management theory	2nd procedural rationality	steps			steps
	3rd structural rationality		stakeholders & activities		stakeholders & activities
	1st substantive rationality			model	model

chapter 9	Reflecting upon PAS
-----------	---------------------

chapter 10	Conclusions and recommendations
------------	---------------------------------

5 PAS steps to achieve alignment

The focus in this chapter is on the component steps of PAS (see [Figure 5.1](#) and [Figure 5.2](#)). CRE alignment is achieved, as has been shown in chapter 4, if stakeholders can use PAS successfully. PAS is successful if the stakeholders are able to perform each step of PAS. I assume that the stakeholders can perform steps 1 (specifying decision variables), 3 (assigning weights) and 4 (determining design constraints) because these type of steps are part of other multi criteria decision analysis as well. However, it is not known if stakeholders are able to perform the new step 2 (determining preferences) and step 5a (design alternatives) and are willing to select the alternative with the highest overall preference score in step 6. Preferably, this new alternative has a higher overall preference score than the overall preference score in the current situation. However, if the boundary conditions are strict this is not always possible. PAS has been tested in three pilots.

This chapter has the following structure:

- TU Delft pilot for the food facilities in paragraph 5.1;
- TU Delft pilot for lecture halls in paragraph 5.2;
- Oracle’s pilot for office locations in paragraph 5.3;
- Pilot study comparison and conclusion in paragraph 5.4.

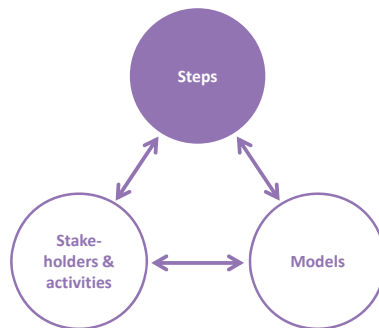

FIG. 5.1 Focus in this chapter
Note adapted from Arkesteijn et al., 2017, p. 245

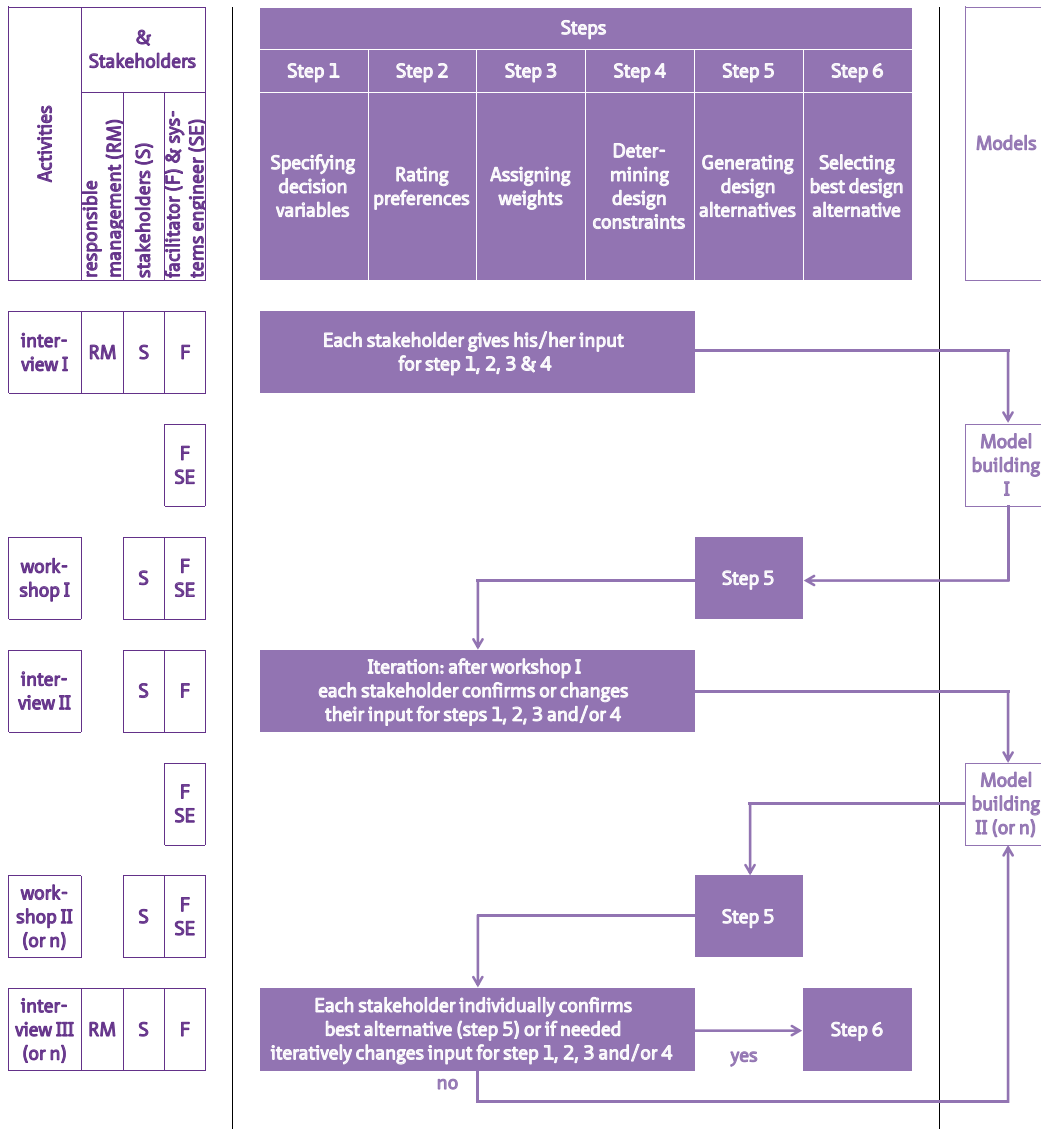

FIG. 5.2 PAS Flowchart; emphasis on steps Note adapted from Arkesteijn et al., 2017, p. 248

5.1 Pilot study 1: TU Delft's food facilities

The results of this pilot study have been published in 2017 in the Journal of Corporate Real Estate. This means that part of the text of the paragraph is reproduced. In this chapter, paragraphs 5.1.1 and 5.1.2 are more elaborate than in the paper or than in pilot 2 and 3 to show how the stakeholders have defined their first set of decision variables³⁸. The pilot study starts with an introduction of the pilot (paragraph 5.1.1), followed by each of the PAS steps.

5.1.1 Introducing the pilot study

TU Delft is located in the city of Delft, between the cities of Rotterdam and The Hague in The Netherlands. At that time [2012], the university accommodated 18,800 students and 7,600 employees (including 1,600 guests). In terms of land and buildings, TU Delft is the second largest university in The Netherlands: its building portfolio consisted of 570,000 m² gross floor area. In addition, the university owns approximately 170 hectares of land. All university buildings are located on a campus south of the city center, between a Canal (the Schie) and a highway (A13). The campus consists of three areas – TUD North, TUD Central and TUD South – each with a unique character. (Arkesteijn et al., 2017, p. 249). (see [Figure 5.3](#))

More than 75% of the total surface area of the university buildings is located in TU Central, the area designated for education and research. TU South is designated for companies affiliated with the university's research activities. TU North accommodates the Architecture Faculty, residential facilities, recreational facilities and small enterprises, owing to the area's close proximity to the city center and architectural features of the buildings, which date from the early 20th century.

A substantial part of its portfolio was built in the 1960s and 1970s and will require largescale renovation in the near future. The university has defined a new campus vision – “the living campus” – and made plans to renovate parts of the campus, to reduce the size of its portfolio and to lower its accommodation costs. The university's facility and real estate department (FMRE) has expressed the desire

³⁸ The cited text is displayed in purple. Only in the first two subparagraphs the parts from the paper will be quoted. Next, to that the figure and table numbers are adjusted to fit in this thesis.

to develop these plans together with the various stakeholders on the campus, to determine which improvements are necessary and where space can be used more effectively and efficiently.

The food facilities on campus (i.e. facilities that serve coffee, lunch and/or dinner) are a critical asset when it comes to realizing a living campus. The ambition of the living campus is to maximize the function of the campus as a place to meet each other and work together. Therefore an important condition for the living campus is to have high-quality food facilities located at strategic locations. The current facilities of TU Delft (**Figure 5.3**) do not meet the requirements of students and staff – especially amongst international users – according to various surveys. The exact requirements of the users are not clear, however: Are the facilities at the wrong locations? Are there not enough facilities that serve coffee, or too many facilities that serve dinner? (Arkesteijn et al., 2017, p. 249). In other words, the CRE portfolio is not aligned with the organization.

The university's campus has fourteen food facilities, which serve coffee, lunch and/or dinner (see **Figure 5.3**). The fourteen food facilities in total have 2.268 places in an area of 3.491 gross floor area (see **Table 5.1**). Most facilities are in ownership of DUT except for the sports center and Inholland. However, because there are located on or adjacent to the campus students and staff are able to use them. Therefore we have taken them into account in this project. As can be seen in the table, two faculty buildings (ARCH and CEG) have two food facilities. In **Figure 5.4** and **Figure 5.5** an impression is given of the food facilities.

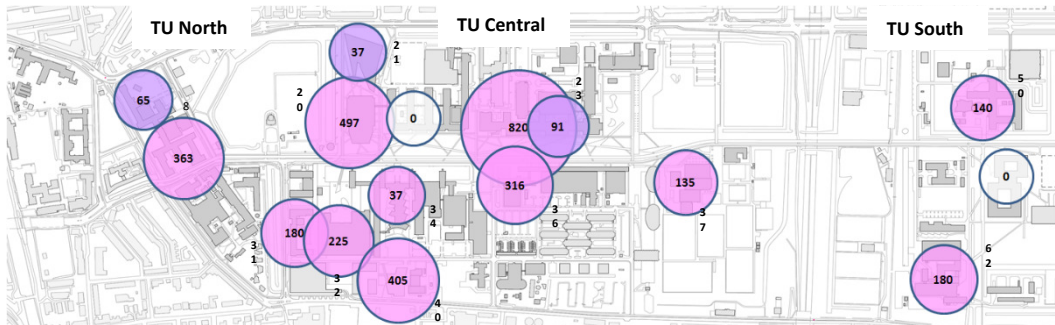

FIG. 5.3 Three areas on the TU Delft's campus Note adapted from Arkesteijn et al., 2017, p. 250 Legend: purple circles: coffee corner, pink circle restaurant; number in circle g.f.a and size of circle corresponding to size of facility. Building numbers added in squares corresponding to **Table 5.1**.

TABLE 5.1 Overview of food facilities and basic data (ordered on building number)

Faculty	Building number	Type of food facility	Gross floor area	# places (i.e. seats)	TUD ownership
Architecture and the built environment (ARCH)	8	restaurant for lunch & diner with coffee corner	363	210	yes
	8	coffee corner	65	60	yes
Auditorium	20	restaurant for lunch & diner with coffee corner	497	267	yes
Library	21	coffee corner	37	32	yes
Civil engineering and Geosciences (CEG)	23	restaurant for lunch	820	450	yes
	23	coffee corner	91	10	yes
Technology, Policy and Management (TPM)	31	restaurant for lunch	180	120	yes
Industrial design Engineering (IDE)	32	restaurant for lunch with coffee corner	225	250	yes
Mechanical, Maritime, Materials Engineering (3ME)	34	restaurant for lunch with coffee corner	37	32	yes
Electrical Engineering, mathematics, Computer Science (EEMCS)	36	restaurant for lunch with coffee corner	316	267	yes
Sports Centre	37	restaurant for lunch with coffee corner	135	90	no
Inholland	40	restaurant for lunch & diner with coffee corner	405	270	no
Reactor	50	restaurant for lunch	140	50	yes
Aerospace engineering (AE)	62	restaurant for lunch	180	160	yes
Total			3.491	2.268	

Many of these food facilities cause dissatisfaction with the university's students and staff. The food facilities are aged and need to be renovated. Representatives from FMRE claim that there is insufficient capacity and quality in the food facilities and insufficient room for commercial food facilities.

The pilot study focuses on the question of how to maximize the function of the living campus by designing a strategy for the university's food facilities. The strategy looks to optimize the amount of food facilities on campus, the types of food facilities and their locations within the campus and buildings based on the specific requirements formulated by users. Which portfolio of food facilities will enable TU Delft to reach her objectives best? The types of questions that need to be answered are: How many food facilities and which types are needed? Where are the food facilities located? What is their preferred size? (Arkesteijn et al., 2017, p. 251).



Building 23, Faculty CEG, restaurant



Building 23, Faculty CEG, coffee corner



Building 31, Faculty TPM, room C



Building 32, Faculty IDE, restaurant



Building 37 Sports Centre, restaurant



Building 40, Inholland, restaurant

FIG. 5.4 Photos food facilities continued Note photos by Arkesteijn & Valks



Building 8, ARCH, restaurant



Building 8, ARCH, coffee corner



Building 20, Auditorium, restaurant



Building 36, EEMCS, restaurant

FIG. 5.5 Photos food facilities continued Note photos by Arkesteijn & Valks

5.1.2 Stakeholders specified decision variables (step 1)

"At the outset of the project, an executive board member was appointed as responsible management who, together with the real estate manager, determined which stakeholders were to participate in the pilot" (Arkesteijn et al., 2017, p. 252). **Figure 5.6** displays the stakeholders that participated in the pilot and the final decision variables they have specified. The executive board as responsible management for real estate projects, the faculty secretary as representative of the faculties, the student council as representative of the students, the works council as representatives of the employees and the project leader social innovation. The latter represents a special university program on social innovation. "Some groups were represented by multiple participants (e.g. the members of the works council), whilst others consisted of only one participant (e.g. the faculty secretary)" (Arkesteijn et al., 2017, p. 252).





decision makers	decision variables
student council 	1 Maximum walking time from a faculty building to a food facility for lunch [minutes]
	2 Maximum walking time from a faculty building to a food facility for dinner [minutes]
	3 Percentage of places in all food facilities which can be used for working [%]
	4 Average vertical location of food facility [floors]
	5 Amount of doors between outside and the food facility [doors]
	6 Average walking time from an entrance to a food facility [minutes]
faculty secretary 	7 Maximum walking time from a faculty building to a food facility for lunch [minutes]
	8 Maximum walking time from a faculty building to a food facility for dinner [minutes]
	9 Percentage of places in all food facilities which can be used for working [%]
	10 Percentage of places in the facilities having sufficient acoustics [%]
	11 Average preference rating on ambience for the food facilities [-]
works council 	12 Maximum walking time from a faculty building to a food facility for lunch [minutes]
	13 Maximum walking time from a faculty building to a food facility for dinner [minutes]
	14 Percentage of food facilities labelled diverse [%]
	15 Average preference rating on coziness for the food facilities [-]
pl social innovation 	16 Percentage of places in all food facilities which can be used for working [%]
	17 Average preference rating on find-ability of the food facilities [-]

FIG. 5.6 Decision makers and their variables Note adapted from Arkesteijn et al., 2017, p. 252

Recall, that in chapter 3, stakeholders in PAS are defined as designers and decision makers; all terms are used interchangeably to refer to them. Before the stakeholders were able to specify the decision variables as shown in [Figure 5.6](#) each stakeholder was interviewed in order to understand their problems and objectives better and translate these objectives into criteria which are important for their group. For each stakeholder group this process will be shown below.

Student council

The student council indicates in the interviews that students experience three main *problems* with the food facilities (see [Figure 5.7](#)³⁹). Firstly, they are dissatisfied with the accessibility of the facilities. Secondly students want to be able to work⁴⁰ in the

³⁹ In the paper the variables have been numbered (Figure 5.4). During the pilot study the variables were organized differently (Figure 5.7). The variables are not in numerical order but the numbers have been added.

⁴⁰ In this thesis, places to work for students are referred to as work places. In other research, these place can be referred to as study places.

food facilities which currently is not possible. There are only some places in the food facilities which can be used as work places. And last but not least the quality of the facilities needs to be improved. The price quality ratio of the restaurants, especially for the luxury sandwiches and the hot meals, is not good, according to the students.

problems	objectives	variables
Accessibility is not good	Quick accessibility	Maximum walking time from a faculty building to a food facility for lunch [minutes] (variable 1)
		Maximum walking time from a faculty building to a food facility for dinner [minutes] (variable 2)
		Average vertical location of food facility [floors] (variable 4)
		Amount of doors between outside and the food facility [doors] (variable 5)
		Average walking time from an entrance to a food facility [minutes] (variable 6)
Can not work in food facilities	Work places in the food facilities	Percentage of places in all food facilities which can be used for working [%] (variable 3)
Price quality ratio is not good	Good price quality ratio	Variable to be used in a later stage of decision making

FIG. 5.7 Summary of problems, objectives and decision variables student council

The students state three *objectives*. They want (1) quick access to the food facilities, (2) study places in the food facilities and (3) a good price quality ratio in the facilities. These objectives are subsequently translated into variables .

The objective *quick accessibility* is translated into different decision variables. Sometimes there is no food facility in the building where students are working. In that case, they have to go to another building. Students indicate that this is only acceptable within certain time limits. They make a distinction between accessibility of a restaurant for lunch and a restaurant for dinner. Lunch facilities need to be much closer to them than the dinner facilities. The *first* variable therefore is the maximum walking time from a faculty building to a food facility for lunch. They ideally want to walk one minute, while three minutes is already too far for them. The *next* variable, number *two*, is the maximum walking time from a faculty building to a food facility for dinner. For dinner students are prepared to walk longer, ideally they walk four minutes or less, while that ten minutes walking is too long. The *next* variable (referred to as number *four*) is about the location of the food facilities. Ideally, they are located on the ground floor while two floors is unacceptable. The variable

is named the average vertical location of food facility. A quick access to the food facilities means they, ideally, want to pass only one door when entering the building before they reach the food facility. The *fifth* variable therefore is the amount of doors between outside and the food facility' The next variable, number *six*, is the average walking time from an entrance to a food facility, which should be ideally only halve a minute. If they have to walk three minutes or more they find this too far.

The next objective students have is that they want work places in the food facilities. For this, the students define their *third* variable the 'percentage of places in all food facilities which can be used for working'. A place is usable as work place only if there is wifi (enough bandwidth) and one socket per place. At the same time, students want the real estate department to indicate clearly at which times these place can be used as work place and when they are solely usable for people eating in the restaurant.

Faculty secretary

In the interviews, the faculty secretary indicates several *problems and objectives* with the food facilities (see [Figure 5.8](#)). The first *problem* for the faculty secretary is that they want to be able to do other activities in the food facilities as well. The food facilities have peak hours during lunch and are less busy in the other hours. The faculty secretary wants to use the food facility in these hours for other activities, like working alone or in groups or maybe even for conferencing. These activities currently cannot be performed in the facilities. The second problem is that they do not like the atmosphere in some of the facilities. Some facilities look outdated. Thirdly, they indicate that the assortment is too much oriented at the Dutch kitchen. Fourthly, there is too much odor, due to staff and students using micro waves to heat their own brought food. This problem is actually a result of problem three , as the microwave is mostly used by international students. And lastly, the hygiene of the restaurant places could be improved. The tables and chairs should be cleaner.

The faculty secretary states four *objectives*. They want (1) multi-functional use of the restaurant places, (2) a more divers offer of food facilities, (3)wider opening hours for the food facilities; since the faculties are open longer as well and (4) a food market with different small food providers. These objectives are mostly translated into variables.

'Walking distances' is an important variable for the faculty secretary, although this was not identified as a problem or objective in the first interview. They use the same variables as the students' variables *one* and *two*. The only difference is that the faculty secretary has different demands for the walking times. Variable *seven* is

‘maximum walking time from a faculty building to a food facility for lunch’. Ideally, they want to walk three minutes, while nine minutes is too far. Variable *eight* is the ‘maximum walking time from a faculty building to a food facility for dinner’. For dinner, the faculty secretary is prepared to walk longer, ideally six minutes or less, while eighteen minutes walking is too long.

problems	objectives	variables
No problem defined	No objective defined	Maximum walking time from a faculty building to a food facility for lunch [minutes] (variable 7) Maximum walking time from a faculty building to a food facility for dinner [minutes] (variable 8)
One-functional use of restaurant places	Multi-functional use of the restaurant places	Percentage of places in all food facilities which can be used for working [%] (variable 9)
		Percentage of places in the facilities having sufficient acoustics [%] (variable 10)
	Wider opening hours	No variable defined
Frigid or outdated atmosphere	A more diverse offer of the food facilities	Average preference rating on ambience in all food facilities (-) (variable 11)
Dutch oriented kitchen		No variable defined
	A food market	No variable defined
Too much odour	No objective defined	No variable defined
Insufficient hygiene	No objective defined	No variable defined

FIG. 5.8 Summary of problems, objectives and variables faculty secretary

The first objective is to have multi-functional places in the food facilities. In order to make the places available for working, the faculty secretary states the ‘percentage of places in all food facilities which can be used for working’ as variable *nine*. This is the same as variable *three* from the students. At the same time, the faculty secretary wants people to be able work in groups of four to eight people in the restaurant. Therefore, it is necessary to have some kind of semi-enclosed compartments in the restaurants, in combination with sufficient acoustics. Presently, most restaurants are one big open plan area with many disturbances. They formulate variable *ten* as the ‘percentage of places in the facilities having sufficient acoustics’.

A more diverse offer of the food facilities, is the faculty secretary’s second objective. The faculty secretary specifies a variable about the ambience in the food facilities,

although they did not specifically set an objective regarding this variable. Ambience is related to the problem of outdated facilities. In order to understand which ambience the faculty secretary likes or dislikes, they were asked to rate all the current facilities on preference for ambience. Variable *e1even* is 'average preference rating on ambience in all food facilities'.

The faculty secretary does not give any variables for 'wider opening hours for the food facilities since the faculties are open longer as well' and 'a food market with different small food providers'.

Works council

The works council represents the employees. In their interviews, they state that they experience several problems with the food facilities (see [Figure 5.9](#)). Firstly, the accessibility of the facilities is not good. The food facilities are far away for some faculty buildings. Secondly, the employees indicate that some food facilities are very busy, especially during peak hours. The capacity is insufficient. This is true for some food facilities, partially due to the closing of a food facility which causes pressure at another food facility. They also indicate that the capacity is even lower during events like conferences, which causes problems for employees and students. However, there are not many conferences in faculty buildings. Some have conferences twice a year. Thirdly, the employees indicate that the food facilities are not diverse. The uniformity is seen in the table sizes. Mostly all tables in a food facility have eight or ten places. Last but not least they indicate that the prices are too high.

problems	objectives	variables
Accessibility food facilities not good enough	Each building should have a lunch facility	Maximum walking time from a faculty building to a food facility for lunch [minutes] (variable 12)
		Maximum walking time from a faculty building to a food facility for dinner [minutes] (variable 13)
Not enough capacity	Food facilities close only very sparsely	No variable defined
Not diverse enough	Diversity and cosiness in the food facilities	Percentage of food facilities labelled diverse [%] (variable 14)
		Average preference rating on cosiness for all food facilities [-] (variable 15)
Price is too high	No objective defined	No variable defined

FIG. 5.9 Summary of problems, objectives and variables for the works council

The employees state three objectives. Firstly, they want that each building has a lunch facility where employees can meet each other during the lunch. Secondly, they want diversity and coziness in the food facilities. And last, they want that the food facilities close only very rarely. These objectives are subsequently translated into variables.

The objective to have a food facility in each building is translated into the two variables accessibility of a restaurant for lunch and a restaurant for dinner. If the walking time is short, this means the food facility needs to be in each faculty building. These are the same variables as variables one and two as indicated by students and faculty secretary. Variable *one* is the 'maximum walking time from a faculty building to a food facility for lunch'. They ideally want to walk two minutes or less to such a facility, while five minutes is too far for them. Variable *two* is the 'maximum walking distance from a faculty to a food facility for dinner'. For dinner employees are prepared to walk longer, ideally they walk three minutes or less, while eight minutes walking is too long.

The objective to have diversity and coziness in the food facilities is translated into the two variables by the employees. The first is variable *ten*, the 'percentage of food facilities labelled diverse'. For each food facility the amount of places per table is counted. The counts shows how many tables for four persons, five, six etc. persons are available in the facility. If, based on the count, it shows that there are many different table sizes the facility is indicated as diverse. If, on the other hand, the table sizes are uniform, the facility is indicated as not diverse. The following variable for the employees is coziness which is based on preference, just like the variable six regarding ambience of the faculty secretary. In order to understand which facilities the employees find cozy or not, they were asked to rate all the current facilities on preference for coziness. Variable *eleven* therefore, is 'average preference rating on coziness for all food facilities'. The works council did not set a variable for the capacity of places.

Project leader Social Innovation

The project leader social innovation indicates in his interviews that he experiences no *problems* with the food facilities (see [Figure 5.10](#)). He states two *objectives*. The restaurant should serve as a space to meet people and he wants the users to be satisfied.

These objectives are translated by the project leader into two variables. Variable *sixteen* is ability to work in the food facilities . This is the same variable as variable *three* of the students and variable *nine* of the faculty secretary. Variable *seventeen* is that the food facility can be easily found. This variable does not have a unit and the preference is given directly, just like variable *eleven* and *fifteen*. He indicates that the facility is easy to find when it is located next to the main entrance. It is still easy to find if it is on the main (traffic) artery. It is, however, less findable than next to the main entrance. The project leader indicates it is not easy to find a restaurant if it is located elsewhere in the building. This is variable *seventeen* 'average preference rating on findability of the food facilities'.

problems	objectives	decision variables
No problems defined	Spaces for meeting each other	Percentage of places in all food facilities which can be used for working [%] (variable 16) Average preference rating on findability of the food facilities [-] (variable 17)
No problems defined	User satisfaction	No variable defined since the users have defined their own variables in this pilot project.

FIG. 5.10 Summary of problems, objectives and variables for the project leader social innovation

unique number	decision variables	number decision variables stakeholders			
		1	7	12	
U1	Maximum walking time from a faculty building to a food facility for lunch [minutes]				
U2	Maximum walking time from a faculty building to a food facility for dinner [minutes]				
U3	Percentage of places in all food facilities which can be used for working [%]				16
U4	Average vertical location of food facility [floors]				
U5	Amount of doors between outside and the food facility [doors]				
U6	Average walking time from an entrance to a food facility [minutes]				
U7	Percentage of places in the facilities having sufficient acoustics [%]		10		
U8	Average preference rating on ambience for the food facilities [-]		11		
U9	Percentage of food facilities labelled diverse [%]			14	
U10	Average preference rating on coziness for the food facilities [-]			15	
U11	Average preference rating on findability of the food facilities [-]				17

FIG. 5.11 Comparison of unique variables (U1 to U11) to numbered variables (1 to 17)

Results step 1: specifying the decision variables

The decision makers specified seventeen decision variables (Figure 5.11). There are three variables which are of interest to four different decision makers: walking time to the middle-sized (variable 1, 7 and 12) and large-sized food facilities (variable 2, 8 and 13) and the number of places in the restaurant which can be used for working (variable 3, 9 and 12). Apart from these variables, which are quantitatively oriented, the decision makers also use qualitatively oriented variables such as ambiance (variable 11) and coziness (variable 15). (Arkesteijn et al., 2017, p. 251).

5.1.3 Stakeholders determined preferences (step 2)⁴¹

For each variable, the decision makers determined a bottom reference alternative (x_0, y_0), a top reference alternative (x_1, y_1) and an intermediate reference alternative (x_2, y_2). For example, Figure 5.12 displays preference ratings of the participant faculty secretary to the variable ‘food facility place as work place.’ The bottom reference (preference score 0) alternative (x_0, y_0) is set at 0 percent, the top reference (preference score 100) alternative (x_1, y_1) is set at 50 percent and the intermediate reference (preference score 80) alternative (x_2, y_2) at 40 percent.

During the pilot, the stakeholders have seen the curves they have defined as presented in Figure 5.13 (works council), Figure 5.14 (student council)⁴², Figure 5.15 (faculty secretary) and Figure 5.16 (project leader social innovation). This gave them visual feedback about their preferences. The preference ratings as coordinates are displayed in Figure 5.17.⁴³

⁴¹ From here the results of the pilot study are shown as presented in paragraph 6.1.2 to 6.1.6 Arkesteijn et al., 2017, pp. 252–257). The cited text is displayed in purple, added text in black. Paragraph, figure and table numbers have been adjusted. In the JCRE paper, the preference curves have only been presented in a table, in this thesis they are also presented as graph. Minor language changes have been made. Colors are synchronized in print version.

⁴² In chapter 4, it has been explained that curve fitting has one disadvantage and that is that it can lead to preference scores above 100 or below 0. This was the case for # doors (variable 5) (in top right corner of Figure 5.14) and in Figure 5.16 % work places (variable 16; also top right corner). The order in which the curves are presented are similar as in the model, which is not the same order as in Figure 5.17.

⁴³ For the variables without a unit (see variable coziness Figure 5.13, ambiance Figure 5.15 and findability Figure 5.16) the preference curve determines the relationship between the average preference score for the total portfolio, i.e. all appropriate objects, to a preference score. The stakeholders have given a preference rating for each of the current facilities (see appendix D).

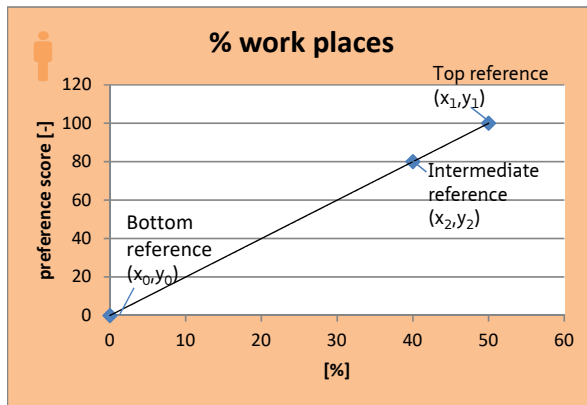

FIG. 5.12 Lagrange curve for the variable “ability to work in the food facility” (see also in Figure 5.17, variable 9); the curve represents the demand and relates the preference rating (vertical axis) to variable value (on the horizontal axis) Note adapted from Arkesteijn et al., 2017, p. 253

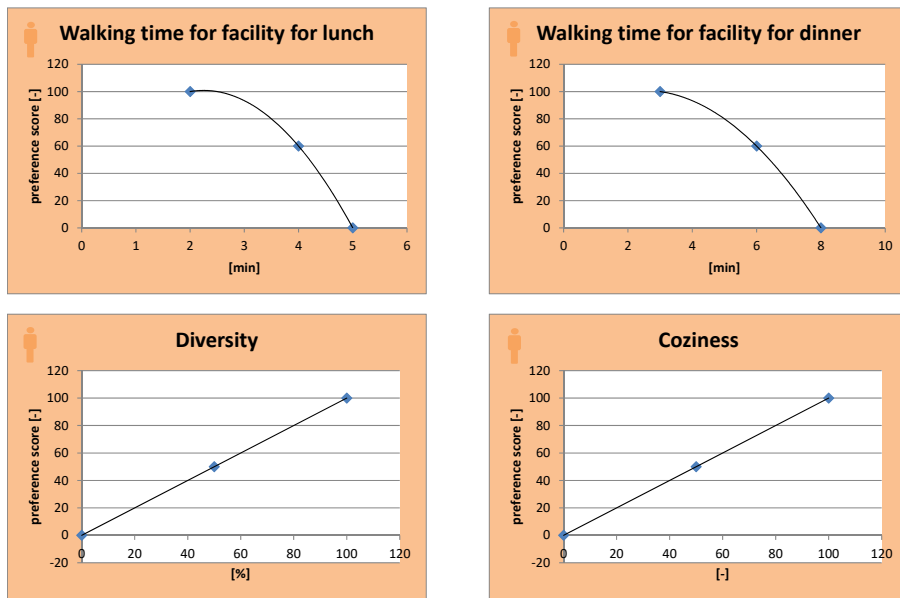

FIG. 5.13 Preference curves works council

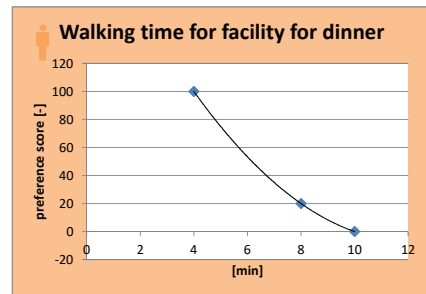
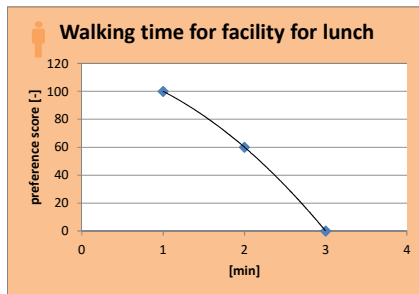
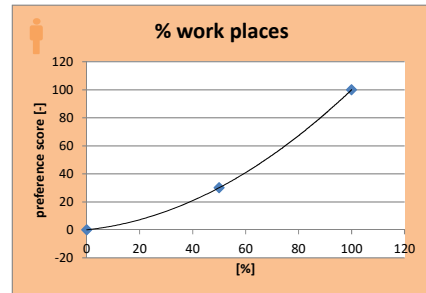
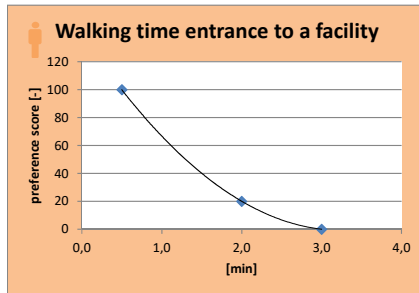
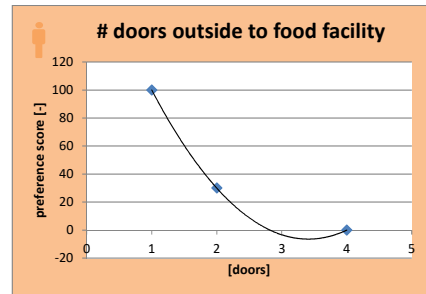
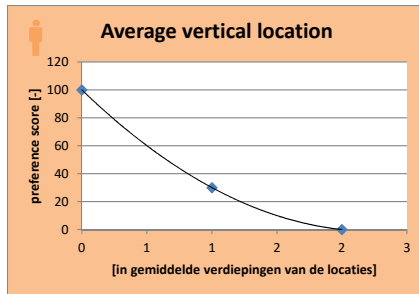

FIG. 5.14 Preference curves student council

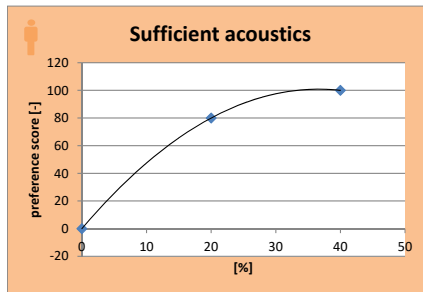
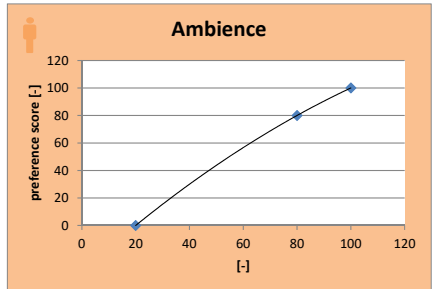
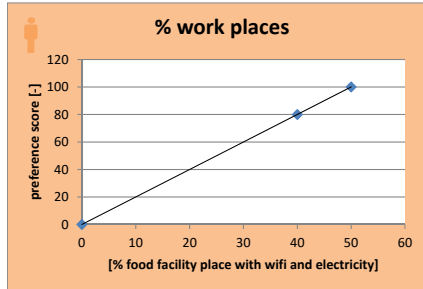
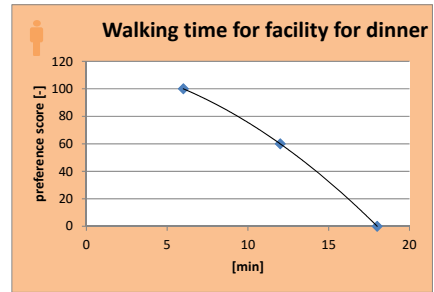
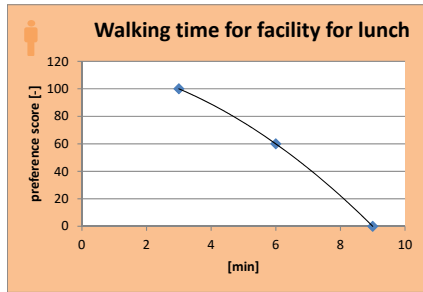

FIG. 5.15 Preference curves faculty secretary

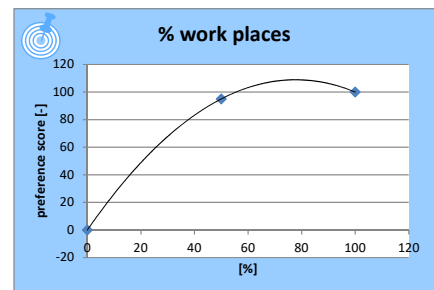
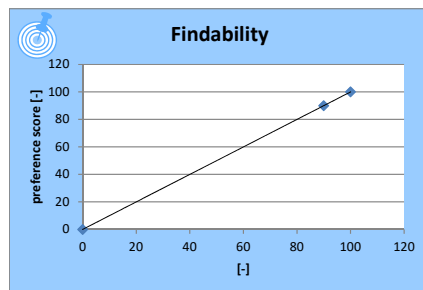

FIG. 5.16 Preference curves project leader social innovation

decision makers	decision variables	$[x_0, y_0]$	$[x_1, y_1]$	$[x_2, y_2]$
student council	1 Maximum walking time from a faculty building to a food facility for lunch [minutes]	[3, 0]	[1, 100]	[2, 60]
	2 Maximum walking time from a faculty building to a food facility for dinner [minutes]	[10, 0]	[4, 100]	[8, 20]
	3 Percentage of places in all food facilities which can be used for working [%]	[0, 0]	[100, 100]	[50, 30]
	4 Average vertical location of food facility [floors]	[2, 0]	[0, 100]	1, 30]
	5 Amount of doors between outside and the food facility [doors]	[4, 0]	[1, 100]	[2, 30]
	6 Average walking time from an entrance to a food facility [minutes]	[3, 0]	[1, 100]	[2, 20]
faculty secretary	7 Maximum walking time from a faculty building to a food facility for lunch [minutes]	[9, 0]	[3, 100]	[6, 60]
	8 Maximum walking time from a faculty building to a food facility for dinner [minutes]	[18, 0]	[6, 100]	[12, 60]
	9 Percentage of places in all food facilities which can be used for working [%]	[0, 0]	[50, 100]	[40, 80]
	10 Percentage of places in the facilities having sufficient acoustics [%]	[0, 0]	[40, 100]	[20, 80]
	11 Average preference rating on ambience for the food facilities [-]	[20, 0]	[100, 100]	[80, 80]
works council	12 Maximum walking time from a faculty building to a food facility for lunch [minutes]	[5, 0]	[2, 100]	[4, 60]
	13 Maximum walking time from a faculty building to a food facility for dinner [minutes]	[8, 0]	[3, 100]	[6, 60]
	14 Percentage of food facilities labelled diverse [%]	[0, 0]	[100, 100]	[50, 50]
	15 Average preference rating on coziness for the food facilities [-]	[0, 0]	[100, 100]	[50, 50]
social innovation	16 Percentage of places in all food facilities which can be used for working [%]	[0, 0]	[100, 100]	[50, 95]
	17 Average preference rating on find-ability of the food facilities [-]	[0, 0]	[100, 100]	[90, 90]

FIG. 5.17 Variables and coordinates of the curves relating decision variable values to preference ratings. Note adapted from Arkesteijn et al., 2017, p. 252

As can be seen this step 1, some decision makers are interested in the same variables. However, they do not give the same preference scores to the same decision variable values (Figure 5.18). For instance, the students want to have the food facility for lunch within a maximum walking [time] of 3 minutes, while the works council prefer this walking [time] to be 8 minutes.

food facility	student council	faculty secretary	works council
Middle	3	9	5
Large	10	18	8

FIG. 5.18 Maximum walking time in minutes per decision maker. Note adapted from Arkesteijn et al., 2017, p. 253

5.1.4 Stakeholders assigned weights (step 3)

The decision makers assigned the weights to each variable that they have specified (Figure 5.19). The weights between the four decision makers were determined by the executive board and were split equally: therefore, each has a weight of 25%.

Both the works council and the faculty secretary give most weight to the walking time for the food facility at lunch time, respectively 30% and 35%. The works council gives 40% weight to the coziness of the food facilities, while the project leader social

innovation is interested in two variables which both receive equal weight. A closer look at the variables and their respective weights shows that there are three types of variables. Variables with regard to location, both on campus and in the building (1, 2, 4, 5, 6, 7, 8, 12, 13, 17), variables regarding the use of the food facility as work place (3, 9, 16), and variables regarding the interior design of the restaurant (10, 11, 14, 15), which respectively account for 53%, 21% and 26% of the weights.

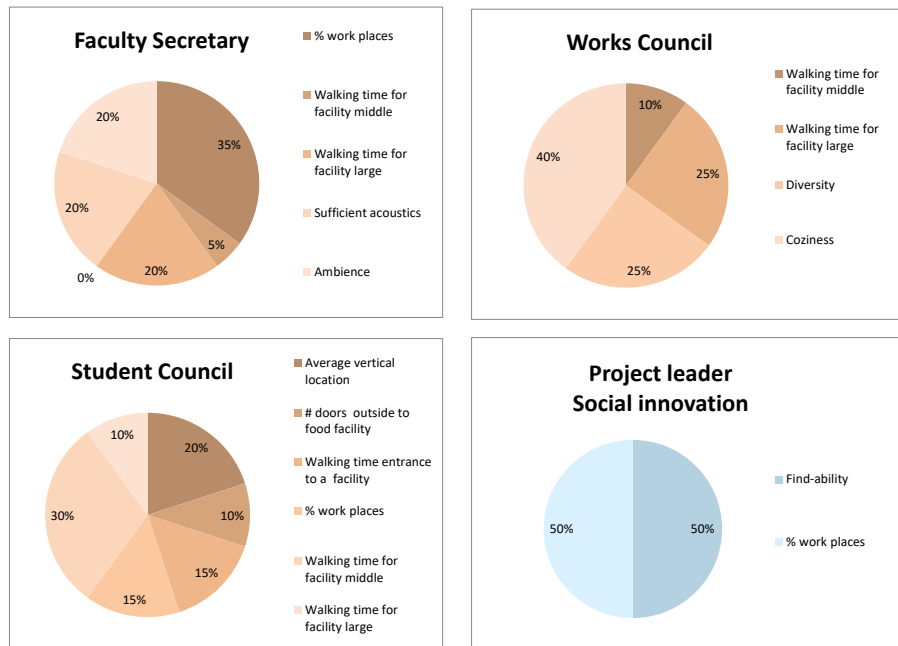

FIG. 5.19 The division of weights per variable, as determined by each decision maker. Note adapted from Arkesteijn et al., 2017, p. 254

5.1.5 Stakeholders determined design constraints (step 4)

A total of six design constraints were determined by the stakeholders. The executive board defined constraints related to variables of other stakeholders. For instance, their constraint user satisfaction is defined as the minimum average satisfaction of the preference score on the variables acoustics (10), ambience (11) and coziness (15). These variables relate to two decision makers. The facility and real estate

department has two constraints based on costs. See **Figure 5.20** for an overview of all design constraints.



decision makers	design constraint		
Executive board 	1	Minimum availability of food facility for lunch within the maximum walking time	95%
	2	Minimum availability of facility for lunch and dinner within the maximum walking time	95%
	3	Minimum availability of facility faculty club within the maximum walking time	95%
	4	Minimum average satisfaction of the preference score on the criteria acoustics, ambience and coziness	40%
FMRE 	5	Maximum investment costs	1.850.000 euro
	6	Maximum operational costs	500.000 euro

FIG. 5.20 Design constraints Note adapted from Arkesteijn et al., 2017, p. 254

5.1.6 Stakeholders designed and chosen the best alternative (step 5a and 6)

The main objective of these step is to try to maximize the overall preference rating by designing alternatives. In step 5a alternatives are designed using the current situation as a starting point. In the current situation the decision maker can choose an intervention for each specific food facility. In this particular case the following types of real estate interventions are identified:

- 1 Refrain from action;
- 2 Remove the food facility;
- 3 Convert the existing food facility to new concept 'middle', 'large' or 'faculty club';
- 4 Create a new concept 'middle', 'large' or 'faculty club';
- 5 Upgrade the existing food facility.

The new concepts 'middle' and 'large' are respectively food facilities exclusively intended for lunch and for both lunch and dinner. However, because the concepts are different from the current food facilities, they have been given a different name. In this step, based on the input from step 1 to 4 and the above-mentioned interventions, a mathematical (formal) model representing the university's food

facilities and the preferences pertaining to them, was created. The model's main interface is the map of the university showing the current situation of food facilities as well as the overall preference score of 44 for this [current] design alternative ... The design alternative with the highest overall preference score is shown in **Figure 5.21**.

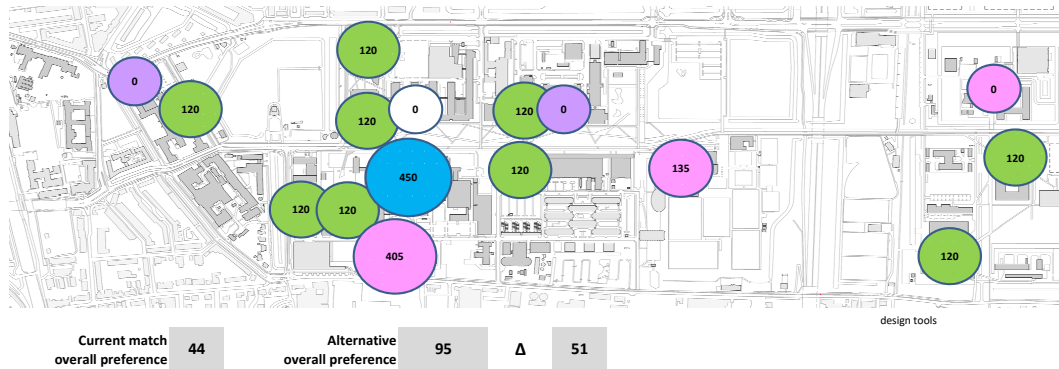

FIG. 5.21 Main interface for generating design alternatives depicting the chosen alternative. Purple circles coffee corners. Pink circles restaurants. Green circles new concept *middle* and blue circles new concept *large* Note adapted from Arkesteijn et al., 2017, p. 255

... The decision makers selected in step 6 the design alternative they had generated with the highest overall preference score as the best alternative (**Figure 5.21** and **Figure 5.22**). This alternative has an overall preference score of 95, which is 51 more than the current situation..





decision makers	decision variables	D ₀	D ₁
 student council	1 Maximum walking time from a faculty building to a food facility for lunch [minutes]	0	60
	2 Maximum walking time from a faculty building to a food facility for dinner [minutes]	0	100
	3 Percentage of places in all food facilities which can be used for working [%]	3	72
	4 Average vertical location of food facility [floors]	100	100
	5 Amount of doors between outside and the food facility [doors]	52	100
	6 Average walking time from an entrance to a food facility [minutes]	60	81
 faculty secretary	7 Maximum walking time from a faculty building to a food facility for lunch [minutes]	89	100
	8 Maximum walking time from a faculty building to a food facility for dinner [minutes]	0	100
	9 Percentage of places in all food facilities which can be used for working [%]	21	100
	10 Percentage of places in the facilities having sufficient acoustics [%]	21	98
	11 Average preference rating on ambience for the food facilities [-]	61	100
 works council	12 Maximum walking time from a faculty building to a food facility for lunch [minutes]	60	100
	13 Maximum walking time from a faculty building to a food facility for dinner [minutes]	0	100
	14 Percentage of food facilities labelled diverse [%]	63	100
	15 Average preference rating on coziness for the food facilities [-]	45	96
 pl social innovation	16 Percentage of places in all food facilities which can be used for working [%]	77	100
	17 Average preference rating on find-ability of the food facilities [-]	11	100

FIG. 5.22 Preference score per variable; current (referred to as column D₀) and chosen design alternative (referred to as column D₁) Note adapted from Arkesteijn et al., 2017, p. 256

Correct measurement of the overall preference score

The stakeholders designed an alternative with an overall preference score of 95. “The overall preference score was determined by using the weighted arithmetic mean instead of using the PFM algorithm (Barzilai, 2010). The latter is not readily available for use, and the weighted arithmetic mean is a good approximation of the overall preference score. This enabled us to give immediate feedback to the decision makers during this [pilot study].” (Arkesteijn et al., 2017, p. 247). In a later stage, the overall preference score of both the current situation (d₀) and the best alternative (d₁) have also been calculated with the PFM algorithm. As can be seen in [Figure 5.23](#), the best alternative has an overall preference score of 95, the same score as calculated with the weighted arithmetic mean during the pilot study. The current situation has an overall preference score of 41, a lower score than the 44 that was calculated with the weighted arithmetic mean.

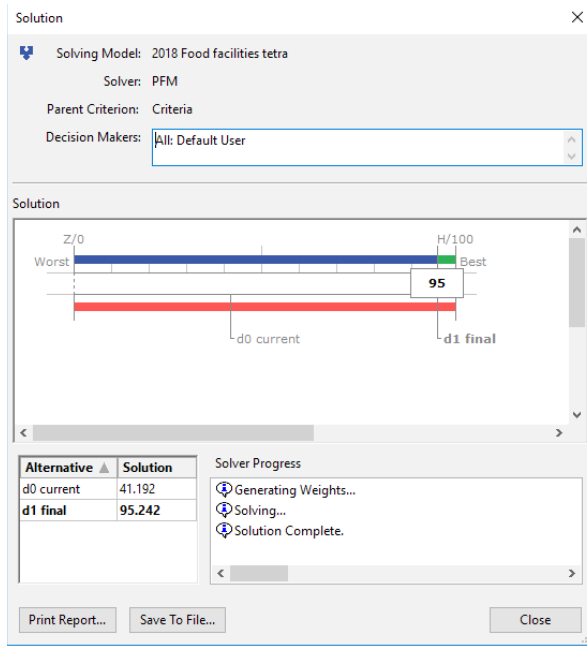

FIG. 5.23 PFM overall preference score of the current situation and the final design (Tetra)

The *best alternative* as presented in Figure 5.21 is accepted by the stakeholders as the final outcome of the design process.

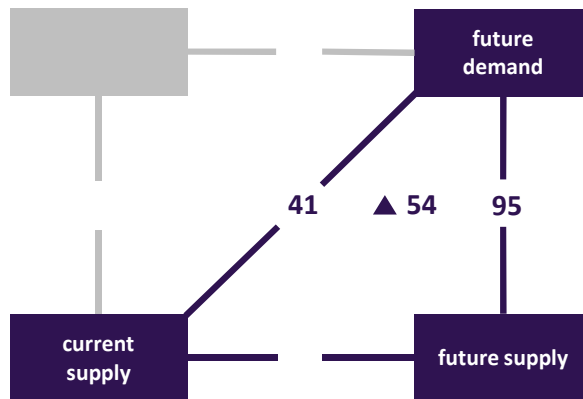

FIG. 5.24 PFM overall preference scores and added value food facilities Note adapted from De Jonge, et al., 2009, p. 36), Van der Zwart et al., 2009, p. 3., Den Heijer, 2011, p. xv.

This design alternative is selected based on the condition that concept 'middle' would not only be a coffee corner but a restaurant with warm meals as well. This was especially important for the decision makers because during the development of the pilot study the definition of the concept 'middle' was not always clear. At certain times it looked as if it would only be a coffee corner, while in the final workshop, the real estate department gave the impression it could be a restaurant with hot meals as well. Therefore, the minutes of the workshop noted this precondition (i.e. that solution is only accepted if the concept 'middle' serves hot meals).

5.2 Pilot study 2: TU Delft's lecture halls⁴⁴

5.2.1 Introducing the pilot study

This pilot study is about the university's large lecture halls: lecture halls exceeding a capacity of 160 seats. The existing and new lecture halls are spread on the TU Delft campus as can be seen in **Figure 5.25**. At the time of the pilot study, a new lecture hall was foreseen at the south end of the campus. An impression of the halls is given in **Figure 5.26**.

This pilot study specifically concentrates on the university's large lecture halls: lecture halls exceeding a capacity of 160 seats (**Figure 5.25**). At the outset of the project, a member of the Board of Directors⁴⁵ was appointed as subject owner.

⁴⁴ The results of this pilot study have been published in Arkesteijn et al., 2014, section 4 and 5, pp. 107-113. The cited text is displayed in purple and added text in black.

⁴⁵ In the first pilot study, the Board of Directors is referred to as Executive Board.

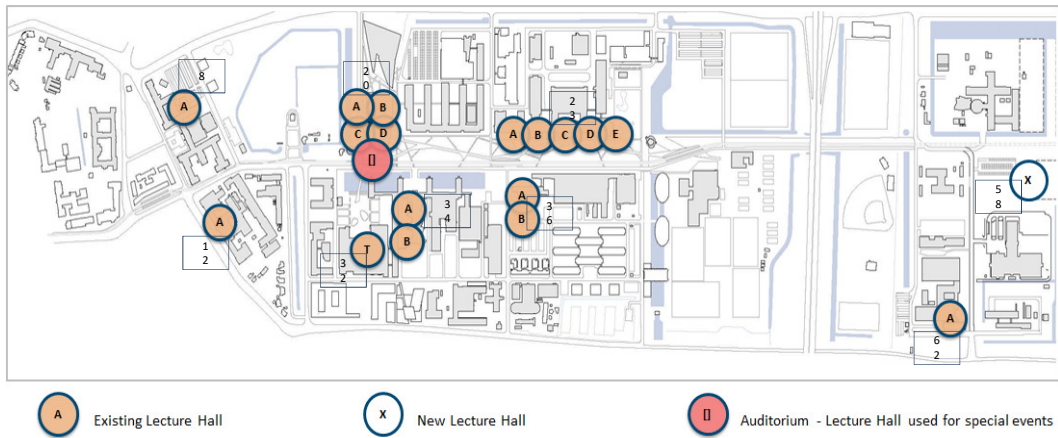

FIG. 5.25 TU Delft, large lecture halls (160+ seats) Note adapted from Arkesteijn et al., 2015 , p. 108 Building numbers are shown in the squares.



Building 20, Auditorium, room A



Building 20, Auditorium, room B



Building 20, Auditorium, room C



Building 20, Auditorium, room D

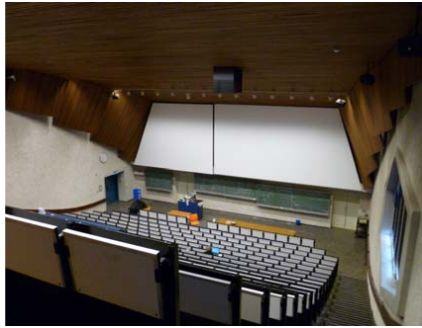

Building 23, Faculty CEG, room A



Building 23, Faculty CEG, room B



Building 23, Faculty CEG, room C



Building 23, Faculty CEG, room D



Building 12, Faculty CE - DTC, room A



Building 36, Faculty EEMCS, room A

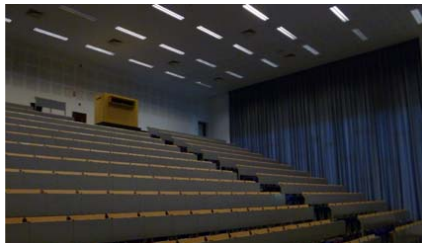

FIG. 5.26 Figure 5.25 Photos of large lecture halls continued Note photos by Walks

The subject owner and the real estate manager find the university's lecture halls to be subject to the following four problems:

- 1 The current supply of lecture halls does not meet present-day requirements with regard to facilities and capacity;
- 2 The university is starting a new undergraduate curriculum in 2013, which will lead to a changing demand for lecture halls;
- 3 There are too few types of educational facilities to accommodate this changing demand;
- 4 The current supply is being used ineffectively: occupancy and utilization rates of lecture halls suggest that an increase in efficiency is possible.

At the time of the pilot study no specific vision, similar to the living campus vision, existed for the educational spaces⁴⁶. The design and decision model must establish a relationship between the demand for educational space and the supply of lecture halls. This relationship can be seen as an indirect relationship (see [Figure 5.27](#)). Indirect firstly because, the teachers give their demand for educational space. They state their demand for lecture halls based on amongst others their type course (lectures, working groups etc.) and the amount of students they expect. Secondly, this demand is processed by Education and Student Affairs (E&S Affairs) who allocates all courses to a timetable. When making their timetable they use the available lecture halls that have been allocated to them by the FMRE department This means that timetabling forms a significant part of problem in the pilot study of the lecture halls.

These three different types stakeholders have, as it showed during the pilot study, conflicting interests. Where the teachers and E&S affairs (often) experience a shortage of space, the FMRE department measure a low(er) occupancy and frequency rates of the lecture halls. The basic tensions between the stakeholders are shown in [Figure 5.28](#). Subsequently, during the pilot it also showed that they expect that the solution needs to be provided by another party.

⁴⁶ The pilot project has served as an input to create university policy on educational spaces: the university's 'Roadmap Education Spaces' (2014).

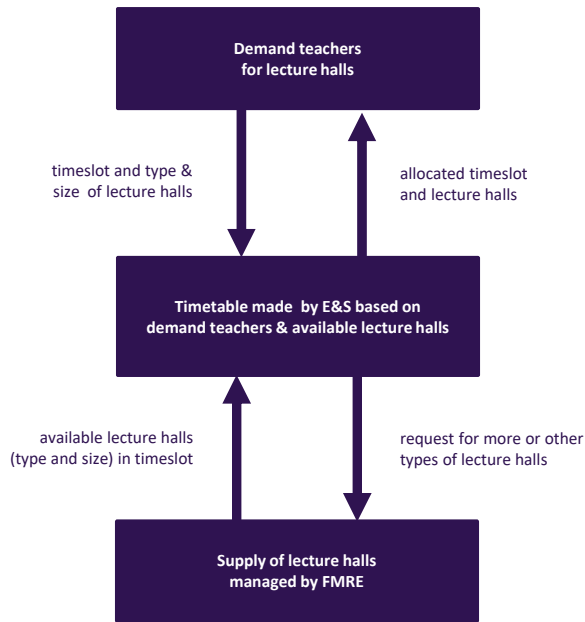

FIG. 5.27 Relationship demand for educational space and supply of lecture halls

In the pilot study not only the abovementioned teachers, E&S Affairs and the FMRE department were involved. **Figure 5.29** displays the stakeholders that participated in the pilot. Some stakeholders consisted of multiple participants (e.g. Education and Student Affairs) whilst others consisted of only one participant (e.g. Board of Directors).

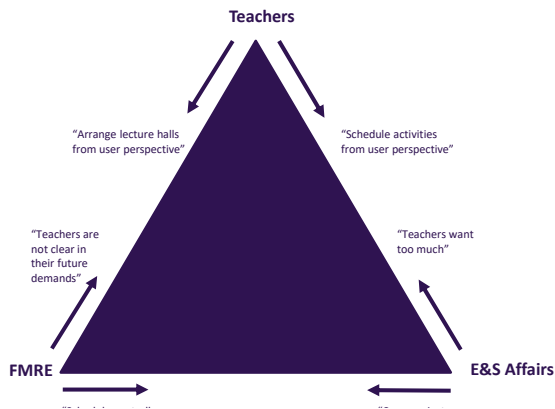

FIG. 5.28 Tensions between teachers, E&S Affairs and FMRE





	stakeholders	examples of criteria
	Board of Directors Directors of Education	Student satisfaction, teacher satisfaction Students in own faculty, availability SMARTboard
	Facility Management and Real Estate	Running costs, occupancy rate
	Student Council Teacher Board	Evening lectures, lectures in own faculty Student walking distance, availability SMARTboard
	Education and Student Affairs	Occupancy rate, Match students/capacity lecture hall

FIG. 5.29 Participating stakeholders in the pilot study Note from Arkesteijn et al., 2015 , p. 109

5.2.2 Stakeholders specified decision variables (step 1)

The criteria defined by each stakeholder (Table 5.6) reveal that the performance of the university's lecture halls depends only partly on the amenities available in the lecture hall. A large part of the performance also depends on the way the lecture halls are used by the university. The users of the lecture halls are generally concerned about the amenities in the lecture halls and the vicinity of the lecture hall to their workplace. The technical managers focus on the efficiency of the portfolio (occupancy rate, costs) while the Board of Directors is interested in both efficiency and satisfied users.

With regard to the amenities in lecture halls, the criteria reveal that some amenities are found to be important or even necessary by multiple users: examples include modern teaching amenities such as Collegerama and four-quadrant beamers. Collegerama is an apparatus for recording lectures, whilst a four-quadrant beamer allows the teacher to work with four separate projections. Other amenities, such as power outlets for laptop use or comfortable chairs are not mentioned at all.

5.2.3 Stakeholders determined preference curves (step 2)

For each variable, the stakeholders determined in step 2 a bottom reference alternative (x_0, y_0) , a top reference alternative (x_1, y_1) and an intermediate reference alternative (x_2, y_2) . The preference ratings displayed in the Figure 5.31 correspond with the preference ratings at the end of the second workshop.

As an example, **Figure 5.30** displays preference ratings of the participant ‘Education and Student Affairs to the criterion ‘occupancy rate.’⁴⁷ In **Figure 5.30**, the bottom reference alternative (x_0, y_0) is set at 100 percent, because the participant has no flexibility left in the timetable if the occupancy rate of the lecture halls is 100 percent. The top reference alternative (x_1, y_1) is set at 70 percent, because the department’s experience is that this leaves enough room in the timetable for extracurricular and/or unforeseen events.

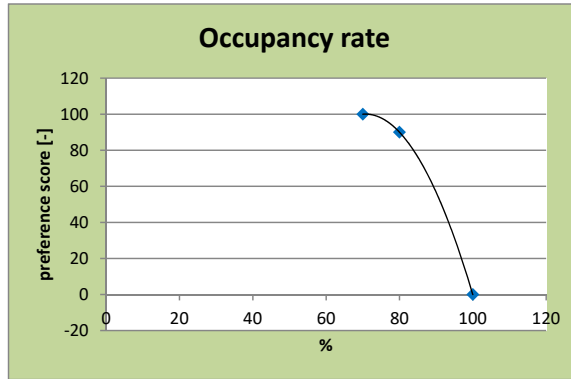

FIG. 5.30 Lagrange curve relating preference rating to the occupancy rate (criterion 32) of the university’s portfolio of lecture halls Note from Arkesteijn et al., 2015 , p. 111



decision makers	criteria	bottom reference (x_0, y_0)	top reference (x_1, y_1)	intermediate reference (x_2, y_2)
Board of Directors 	1 Education in small groups (% of total hours scheduled)	[0, 0]	[50, 100]	[40, 80]
	2 Student satisfaction (% of preference score on criteria 13-21)	[45, 0]	[85, 100]	[75, 80]
	3 Teacher satisfaction (% of preference score on criteria 22-29)	[45, 0]	[85, 100]	[75, 80]
	4 Occupancy rate (hours scheduled / capacity in hours)	[30, 0]	[70, 100]	[55, 80]
Directors of Education 	5 First year students: lectures in own faculty (% of total hours scheduled)	[25, 0]	[90, 100]	[70, 75]
	6 Second year students: lectures in own faculty (% of total hours scheduled)	[20, 0]	[60, 100]	[40, 70]
	7 Third year students: lectures in own faculty (% of total hours scheduled)	[0, 0]	[20, 100]	[10, 4]
	8 Appropriate classroom size (ratio between students and lecture hall capacity)	[150, 0]	[100, 100]	[120, 60]
	9 Availability of four-quadrant beamer (% of lecture halls)	[30, 0]	[100, 100]	[60, 80]

FIG. 5.31 Criteria and their respective preferences Note adapted from Arkesteijn et al., 2015 , pp. 110-111

⁴⁷ The criterion occupancy rate shows that revealed preferences of the past (low occupancy rates) can also be used as design criterion. This reflects in the preference ratings.

decision makers	criteria	bottom reference (x_0, y_0)	top reference (x_1, y_1)	intermediate reference (x_2, y_2)
Directors of Education (continued)	10 Availability of blackboard and beamer (% of lecture halls)	[80, 0]	[100, 100]	[90, 60]
	11 Availability of flexible chairs (% of lecture halls)	[0, 0]	[30, 100]	[15, 60]
	12 Education in small classrooms (% of lecture halls)	[2, 0]	[12, 100]	[8, 70]
Student Council	13 Amount of lectures recorded (Collegerama) (% of lectures in lecture halls with Collegerama)	[75, 0]	[100, 100]	[80, 30]
	14 Amount of lectures in the evening (% of lectures scheduled after 5:00 PM)	[2, 0]	[0, 100]	[1, 40]
	15 Amount of movements between buildings (% of total lectures in another building than previous)	[3, 0]	[0, 100]	[2, 20]
	16 Lectures in own faculty (% of total hours scheduled)	[50, 0]	[100, 100]	[75, 60]
	17 First year students: lectures in own faculty (% of total hours scheduled)	[25, 0]	[90, 100]	[75, 70]
	18 Second year students: lectures in own faculty (% of total hours scheduled)	[20, 0]	[80, 100]	[50, 70]
	19 Third year students: lectures in own faculty (% of total hours scheduled)	[0, 0]	[50, 100]	[25, 20]
	20 Availability smartboard or four-quadrant beamer (% of lecture halls)	[20, 0]	[100, 100]	[50, 30]
	21 Flexible lecture halls (% of lecture halls)	[0, 0]	[30, 100]	[15, 60]
	Teachers	22 Standard equipment (% of lecture halls)	[0, 0]	[100, 100]
23 Blackboards/whiteboards (% of lecture halls)		[50, 0]	[100, 100]	[80, 60]
24 Flexible chairs (% of lecture halls)		[30, 0]	[80, 100]	[60, 60]
25 Walking distance for students (minutes)		[15, 0]	[5, 100]	[10, 25]
26 Amount of lectures recorded (Collegerama) (% of lectures in lecture halls with Collegerama)		[0, 0]	[100, 100]	[80, 90]
27 On-site assistance (minutes)		[10, 0]	[2, 100]	[5, 20]
28 Assistance in transport of teaching materials (hours)		-	-	-
29 Reservation of parking spots (% of parking spots available on-demand for teachers)		[0, 0]	[100, 100]	[20, 20]
30 Walking distance for students (minutes)		[15, 0]	[5, 100]	[10, 50]
E&S Affairs	31 Appropriate classroom size (ratio between students and lecture hall capacity)	[150, 0]	[100, 100]	[125, 80]
	32 Occupancy rate (hours scheduled / capacity in hours)	[100, 0]	[70, 100]	[80, 90]
	33 Functionality of lecture hall equipment (% of total hours in which there are no defects)	[95, 0]	[99, 90]	[100, 100]
FMRE	34 Occupancy rate (hours scheduled / capacity in hours)	[0, 0]	[70, 100]	[40, 50]
	35 Appropriate classroom size (ratio between students and lecture hall capacity)	[50, 0]	[90, 100]	[75, 80]
	36 Running costs (€)	[130, 0]	[100, 100]	[110, 80]

FIG. 5.31 Continued

5.2.4 Stakeholders assigned weights (step 3)

The weights the stakeholders assigned to each criterion are displayed in [Figure 5.32](#) below. The weights between the stakeholders were determined by the board of directors to be split equally: therefore each stakeholder has a weight of 16.67%.

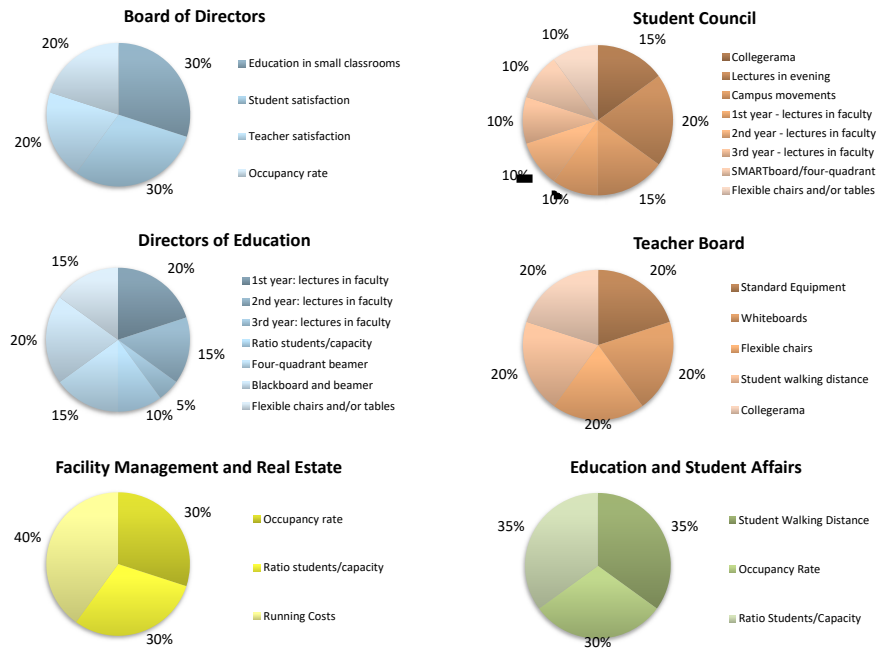

FIG. 5.32 The division of weights per criterion, as determined by each stakeholder Note Arkesteijn et al., 2015, p. 112

5.2.5 Stakeholders determined design constraints (step 4)

A total of five design constraints were determined by the stakeholders, mostly related to scheduling issues rather than real estate issues. What the design constraints also reveal is that for Education and Students Affairs, the priority is to timetable all the university's activities within the specified constraints. Once this is achieved, a certain efficiency is desirable (see criteria): i.e. finding a good student/capacity ratio only becomes important after a solution is found that incorporates all design constraints (See **Figure 5.33**).



decision makers	design constraint
Student Council 	1 Two-way interaction with the teacher at all times
	2 The amount of students present cannot exceed the lecture hall capacity
E&S Affairs 	3 DUT must have enough capacity to accommodate all mandatory activities
	4 The maximum amount of scheduled hours per student per day is eight hours
	5 Mandatory courses cannot be scheduled at the same time

FIG. 5.33 Design constraints incorporated into the scheduling model Note adapted from Arkesteijn et al., 2015, p. 112

5.2.6 Stakeholders designed and chosen the best alternative (step 5a and 6)

The main objective of designing alternatives is to maximize the overall preference rating. In this particular case two types of interventions are possible: organizational and real estate interventions. With regard to the timetable, the following organizational interventions are possible:

- Set boundary conditions on the percentage of lectures in the own faculty;
- Enable/disable scheduling in the evening hours;
- Enable/disable scheduling in the lunch hours;
- Set the allowed walking distance between lectures to 5, 10 or 15 minutes;
- Enable/disable the new education programs in the bachelor phase; enabling will lead to less lectures;
- Set the amount of options given by the teacher for a suitable moment to high, medium or low;
- Vary the amount of total students on the campus.

Table 5.2 shows the values of these interventions in the current situation (design alternative d_0) and in the resulting design alternative of the second workshop. In the workshops, the first objective for the participants was to maximize the amount of lectures in the own faculty. Because fixing these values leads to a reduction of the feasible set ^[48], other variables were set to increase flexibility: adding new bachelor programs, increasing walking distance and the amount of options (in time) given by the teachers.

⁴⁸ In the mathematical model, the feasible set refers to the set of decision variables that can be set to a value of one. The smaller the feasible set, the less likely it is that the model is able to generate a feasible solution.

TABLE 5.2 Scheduling result, for design alternative d_0 [current] and d_1 [future]. The input value can be changed by the decision makers to optimize the scheduling result (layout adapted) Note from Arkesteijn et al., 2015 . p. 114

Variable	Current (Design alternative d_0)		Future (Design alternative d_1)	
	Input value	Scheduling result	Input value	Scheduling result
1a First-year students in own faculty	Unconstrained	47%	>= 65%	65%
1b Second-year students in own faculty	Unconstrained	28%	>= 40%	40%
1c Third-year students in own faculty	Unconstrained	15%	>= 15%	15%
2 Lectures in evening hours	Not possible	0%	Not possible	0%
3 Lectures in lunch hours	Not possible	0%	Not possible	0%
4 Allowed walking distance	Max. 5 minutes	4.7 minutes on average	Max. 15 minutes	5.2 minutes on average
5 New bachelor programs	Off	496 lectures per week	On	425 lectures per week
6 Amount of options given by teacher	Low	6,830 possible time slots for 496 lectures	High	12,639 possible time slots for 425 lectures
7 Amount of students	= 100%	-	= 100%	-

With regard to real estate, a range of interventions could be applied to each lecture hall:

- 1 Remove lecture hall;
- 2 Do nothing;
- 3 Renovate lecture hall (by doing one or more of the following)⁴⁹;
 - a Add power sockets;
 - b Add internet;
 - c Add four-quadrant beamer;
 - d Add blackboard;
 - e Add whiteboard;
 - f Add smartboard;
 - g Add Collegerama (recording device);
 - h 1. Add swiveling chairs;
 - i 2. Add flexible chairs and tables;
- 4 Add new lecture hall.

⁴⁹ The numbers A to H2 have been added, because they have not been displayed in the paper.

Figure 5.34 displays the portfolio of lecture halls in the current and future design alternatives. With the exception of lecture hall 1 all the existing lecture halls have been renovated. Lecture hall 19 could have been added to the portfolio if necessary, but in the design alternative this option was not used. The combination of design interventions in the timetable and the lecture halls yielded the following design result per criterion (Figure 5.35).

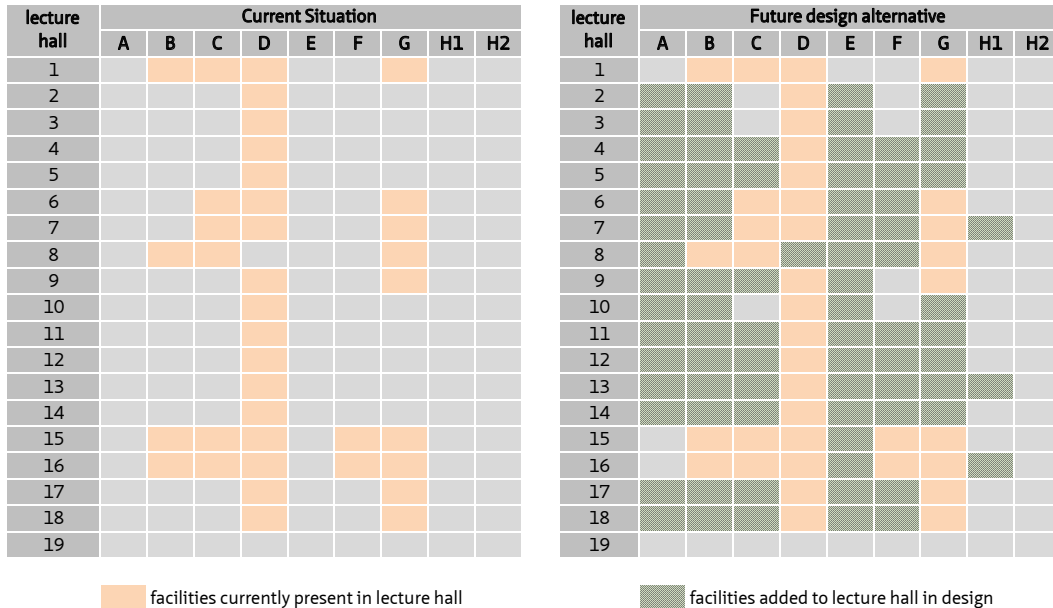

FIG. 5.34 Portfolio result, current and future. The numbers A-H2 correspond with the interventions named above Note from Arkesteijn et al., 2015 , p. 115

The stakeholders designed an alternative with an overall preference score of 69 (also referred to as d_1 and future design), based on the weighted arithmetic mean. The overall preference score for the current situation is 58. This means that the added value in this pilot was 11. The added value is calculated as follows: overall preference score for the final design (69) minus overall preference score for the current situation (58).







decision makers	criteria	current situation	future design alternative
Board of Directors 	1 Education in small groups	87	100
	2 Student satisfaction	0	43
	3 Teacher satisfaction	57	88
	4 Occupancy rate	100	94
Directors of Education 	5 First year students: lectures in own faculty	40	68
	6 Second year students: lectures in own faculty	33	70
	7 Third year students: lectures in own faculty	35	53
	8 Appropriate classroom size	25	17
	9 Availability of four-quadrant beamer	0	88
	10 Availability of blackboard and beamer	79	100
	11 Availability of flexible chairs (% of lecture halls)	0	69
	12 Education in small classrooms (% of lecture halls)	-	-
Student Council 	13 Amount of lectures recorded (Collegerama)	0	93
	14 Amount of lectures in the evening	100	100
	15 Amount of movements between buildings	66	72
	16 Lectures in own faculty (% of total hours scheduled)	0	0
	17 First year students: lectures in own faculty	-	-
	18 Second year students: lectures in own faculty	-	-
	19 Third year students: lectures in own faculty	-	-
	20 Availability smartboard or four-quadrant beamer	9	56
	21 Flexible lecture halls (% of lecture halls)	0	69
Teachers 	22 Standard equipment (% of lecture halls)	92	100
	23 Blackboards/whiteboards (% of lecture halls)	65	100
	24 Flexible chairs (% of lecture halls)	0	0
	25 Walking distance for students (minutes)	100	96
	26 Amount of lectures recorded (Collegerama)	69	99
	27 On-site assistance (minutes)	-	-
	28 Assistance in transport of teaching materials	-	-
	29 Reservation of parking spots	-	-
E&S Affairs 	30 Walking distance for students (minutes)	100	98
	31 Appropriate classroom size	37	25
	32 Occupancy rate	37	25
	33 Functionality of lecture hall equipment	-	-
FMRE 	34 Occupancy rate	100	88
	35 Appropriate classroom size	72	68
	36 Running costs (€)	-	-
total		58	69

FIG. 5.35 Preference score per variable; current (d_0) and future design alternative (d_1) Note from Arkesteijn et al., 2015 , p. 116

Correct measurement of the overall preference score

As explained in the first pilot, “the overall preference score was determined by using the weighted arithmetic mean instead of using Barzilai’s PFM algorithm” (Arkesteijn et al., 2017, p. 247). In a later stage, the overall preference score of both the current situation (d_0) and the best alternative (d_1) have also been calculated with Barzilai’s PFM algorithm. As can be seen in [Figure 5.36](#), [Figure 5.37](#) the best alternative has an overall preference score of 70 (69,769). This is very close to the overall preference score of 69 that was calculated with the weighted arithmetic mean during the pilot study. The current situation has an overall preference score of 53 (52,635), a lower score than the 58 that was calculated with the weighted arithmetic mean.

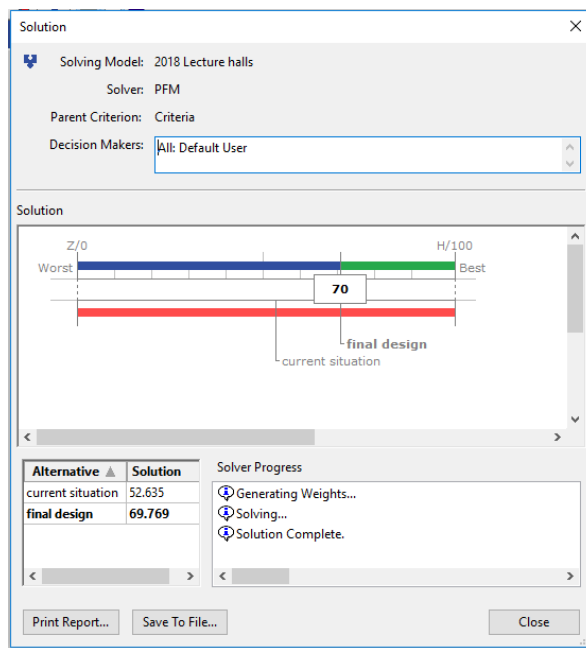

FIG. 5.36 PFM overall preference score of the current situation and the final design (Tetra)

The best alternative as presented in [Figure 5.35](#) (also referred to as d_1 , final) is accepted by the stakeholders as the final outcome of the design process. This alternative has an overall preference score of 70 (PFM algorithm) for the final design alternative and an overall preference score of 53 for the current situation. The added value is 17.

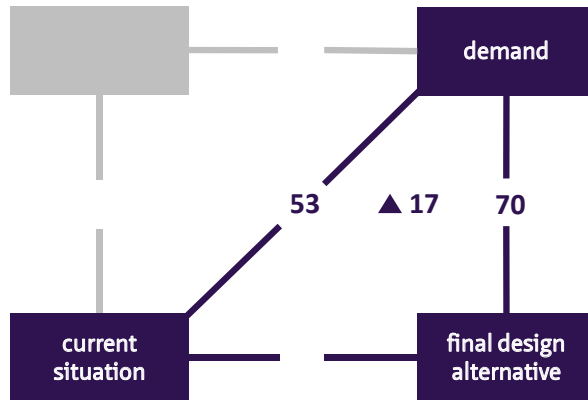

FIG. 5.37 PFM overall preference scores current situation and best alternative as well as added value lecture halls Note adapted from De Jonge, et al., 2009, p. 36, Van der Zwart et al., 2009, p. 3, Den Heijer, 2011, p. xv.

5.3 Pilot study 3: Oracle's office locations

The third pilot study was conducted at Oracle, a multinational ICT company, by graduate student De Visser in 2016. This pilot study is presented in this thesis for four reasons:

- Firstly, to show that PAS can be successfully used in a different type of organization. Oracle is a multinational company and differs a lot from the context of a public university.
- Secondly, that PAS can also be used for a different type of problem. The problem in this pilot was the choice of a new office location.
- Thirdly, Oracle currently uses a scorecard process for the selection of new office locations. This scorecard process is an advanced system to make well-funded decisions in a transparent process. From the perspective of the preference measurement paradigm, as explained in chapter 3, their process does not make use of strong scales. This makes it possible to compare the PAS procedure to the original scorecard process. Does PAS reflect the stakeholders preferences better than the current process? And are the results of PAS better than the current outcome.
- And lastly, in the Oracle pilot an optimization tool has been tested. This makes it possible to determine on the one hand if it is possible to achieve better results with an optimization tool than with the PAS design and on the other hand whether the results from the optimization tool are acceptable for the stakeholders.

This pilot study was confidential therefore only the final results of the pilot will be presented anonymously. This means that step 6 will be discussed but that the results of the previous steps will not be presented here. The pilot is extensively reported in De Visser (2016) and De Visser, Arkesteijn, Binnekamp, and De Graaf (2017). The pilot study is introduced in paragraph 5.3.1 and the results are shown in paragraph 5.3.2.

5.3.1 **Introducing the Oracle pilot study office locations**

In this pilot study there was an unique opportunity to compare PAS to the current office location decision process. Therefore the current decision making process will be introduced more extensively. Subsequently, the company and its corporate real estate management, the current real estate location decision making process, the specific case and the pilot study will be described. This paragraph is based on De Visser, 2016, pp. 59-63⁵⁰.

Oracle and its corporate real estate management

Oracle⁵¹ is a globally operating ICT company that provides its services in more than 145 countries. They provide hardware, software and data storage services to a range of industries, from education and banking to high tech engineering companies and the public sector. ... Altogether, the company has more than 130.000 employees, spread over four global regions with total revenues of US\$38.2 billion over 2015. All employees and data servers need accommodation and the portfolio should stay aligned with the business (De Visser, 2016, p. 58).

Real estate strategy making and alignment to the business is done by the Advanced Planning (AP) Team. The real estate departments of the four global regions take care of the execution of the strategy, accompanying transactions and possible interventions. In general Oracle's real estate organization maintains close ties with the business, with the result that [line of businesses] LOBs contact the organization in case they want to make considerable changes in their portfolio. This improves the control over the execution of a high-level real estate strategy. The alignment

⁵⁰ The long citations and summarised text are displayed in purple.

⁵¹ De Visser based the content of his chapter on an interview about corporate real estate (CRE) alignment held by Arkesteijn and Kuijpers with Smith, vice president Global Real Estate and Facilities at Oracle. As well as project meetings with De Visser's mentors Leipner-Srebnick, director Real Estate Advanced Planning, and Davenport, Global Location Strategy Programme manager within at Oracle's Advanced Planning team.

between the real estate and the business is maintained by monitoring a lot of object characteristics, the resulting data is made insightful in a dashboard environment and is reported monthly. In addition to these reports, the organization keeps track of the effects of planned interventions on the portfolio in a so-called Plan of Records that shows the development of the portfolio over time. This tool is used to evaluate the decisions and provide insight in when they will influence the portfolio data. ... In addition to the studies, the real estate department works with a mission statement that is shared among the regional real estate departments to be used in their daily activities. Furthermore certain targets are connected to the data that is monitored, which can be used to decide upon interventions to improve the alignment (De Visser, 2016, p. 58-59).

The current real estate location decision making process

The AP team conducts roughly two types of studies; the low cost location studies per global region and LOB specific studies upon request of a specific LOB. LOBs ask the AP team to view the results of a low cost study in their region and pick a location after having had the possibility to adapt the weights that were initially assigned to the variables. In this way, the AP team keeps track of the alignment of the LOBs with the study outcomes. Sometimes, the presentation of a low cost study results in an additional study for the specific LOB, often because they search for a different location with other criteria (De Visser, 2016, p. 59). See **Figure 5.38**.

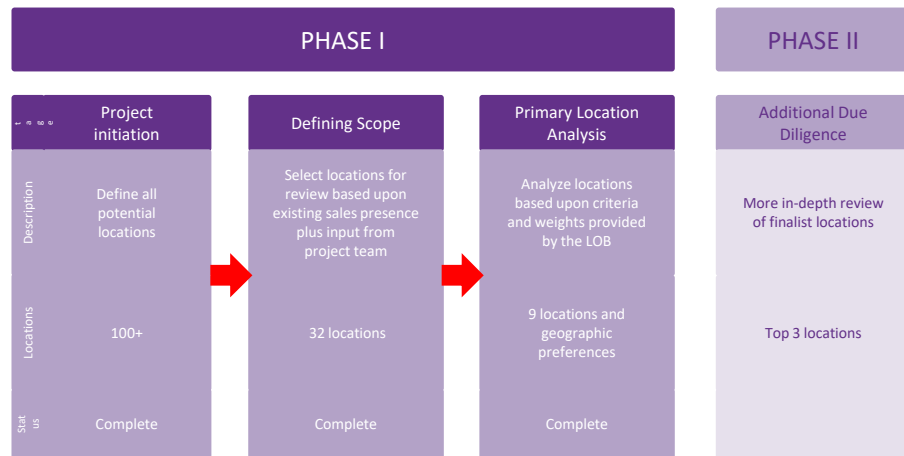

FIG. 5.38 The process followed in [original] study Note adapted from Davenport in De Visser, 2016, p. 60

The Advanced Planning (AP) team conducts specific location studies in order to identify locations, i.e. cities or metropolitan areas, where a Line of Business (LOB) can expand its activities. The team uses a scorecard process in order to rate a selection of locations on a set of criteria with weights that are adapted by the LOB. The LOB then selects a location from the resulting ranking of locations (De Visser, 2016).

The case

The case used in this research and design project consists of an LOB specific location study, conducted by the AP team. The original study started upon the request of LOB 1 to propose up to three locations for a new hub in the global region covering Europe, Middle- East and Africa (EMEA). LOB 1 is expecting to grow considerably in the coming years, which means that the current portfolio is not able to accommodate the increasing number of employees. The new hub should be operational in 2018. The general aim of the new hub is to attract millennials, a generation of people that is born around the time of the millennium, i.e. the year 2000, and is grown up with computers, smartphones and the internet. The main variable for the location is the attractiveness to native English speakers, in addition to this, costs should be taken into account as a less influential criterion. Based on the request by LOB 1, the AP team previously established a set of criteria, making use of a report³ that presents a set of indicators that are found to attract millennials to cities (De Visser, 2016, p. 61). (see **Figure 5.39**)

In this case the AP team defined 39 criteria including some cost criteria. All criteria were confirmed by the representative of the LOB, who also assigned the weights to the criteria. The AP team then proceeded with searching for the required data for each of the criteria and assigned the arrays covered by the 1-5 scale, just like in the low cost studies. The arrays were checked globally by the LOB, however, they mostly relied on the assessment of the AP team. After the rating was established, the locations were rated based on the data, and the weighted average rating was calculated. The representative of the AP team indicated however, that it was rather complex for the stakeholders to determine the appropriate weights for the criteria. After the outcome of the scorecard was known, a selection of the nine best-rated locations (current locations excluded) was assessed in more detail on an additional set of qualitative aspects. This resulted in a set of strengths and weakness per location, that was used to make the recommendation for a final selection of three location alternatives. Based on this selection, the final decision for a new location was made by the representative from the LOB (De Visser, 2016, p. 60).

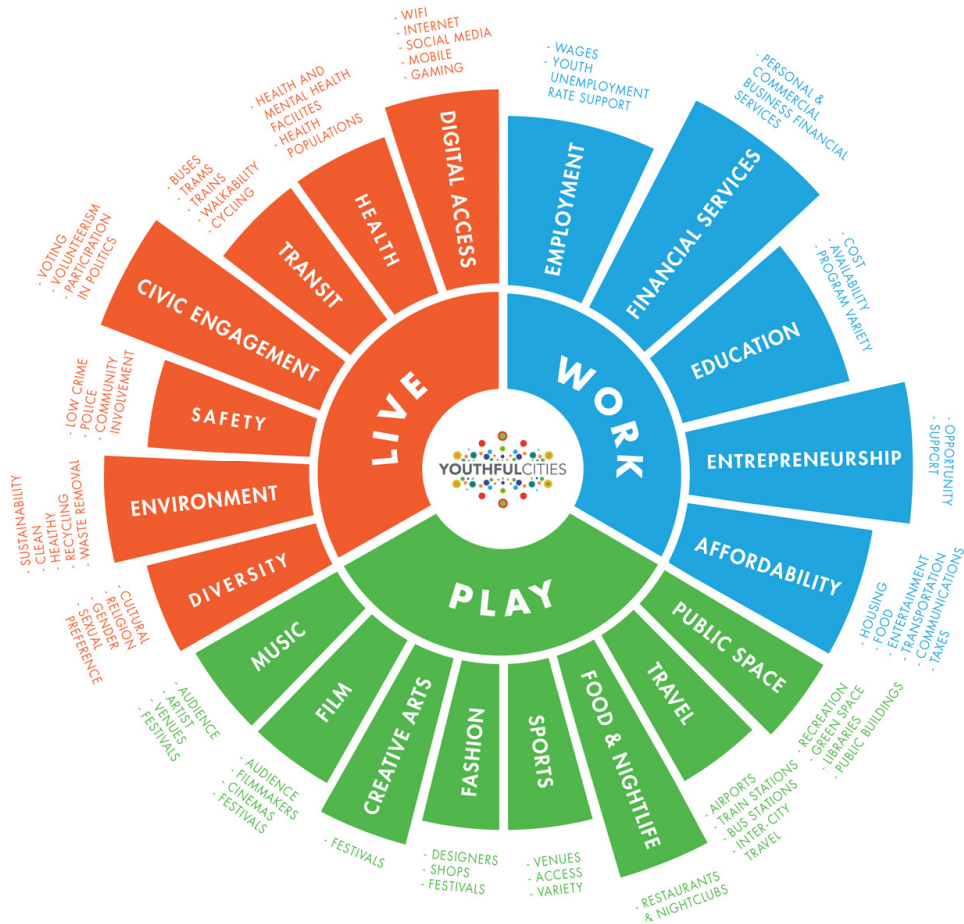

FIG. 5.39 Indicators for attracting millennials Youthful-Cities in De Visser, 2016, p. 61

The pilot study

The original scorecard comprised of 39 variables that are sorted in five categories. Each category is connected to a weighing. The scorecard takes the average of the variables ratings in each category to calculate the category rating. The weighted average of those five category ratings provides the overall rating for each location. However, to make the case better to handle and because multiple variables cover the same aspects, a selection of 22 variables is made for this pilot study. This selection is made in such a way that for all five categories a representative set of variables remains (De Visser, 2016, p. 62). (see [Table 5.3](#))

TABLE 5.3 Categories of interest covered by criteria Note from De Visser, 2016, p. 62

Categories of interest
Costs
Ease of sourcing native speakers & millennials
Labor environment
Fit to LOB 1 EMEA vision and value proposition
Government support

5.3.2 Stakeholders chosen the best alternative (step 6)

Before the results are presented, it is good to remember that in this pilot three alternatives have been designed and compared to the current portfolio.

- 1 The first alternative is the LOB's current choice as output of their own scorecard process (referred to as *LOB's choice*);
- 2 The second alternative is the optimum feasible portfolio alternative designed by the stakeholders (referred to as *Optimum design*);
- 3 The third alternative is the alternative that has been generated by the optimization tool (referred to as *Global optimum*).

The results for all alternatives are presented in [Table 5.4](#).

The number one portfolio alternative, Global optimum, has a higher preference rating than found by the stakeholders. The Global optimum portfolio alternative provides an improvement of 7% in the preference rating over the current portfolio, whereas the optimum found through design achieves an improvement of 5% (De Visser, 2016, p. 85).

The *Optimum design* is accepted by the stakeholders as the final outcome of the design process, which confirms that the model closely reflects their preferences. Later, after the Global optimum has been presented to them, the stakeholders indicated that they expected such an outcome and accept this as the final outcome of the pilot study. This shows that it is possible to find a portfolio alternative with a better preference rating than the stakeholders are able to find. Compared to Oracle's current scorecard system, the location ranking from the PAS model showed an improvement in the representation of the users' location preferences, induced by the use of preference curves (De Visser, 2016).

TABLE 5.4 Comparison of optimum portfolio alternatives to the current portfolio and the actual choice by LOB 1 Note adapted from De Visser, 2016, p. 83 legend: Locations in purple are part of 3 or more alternatives

Name	Current portfolio	LOB's choice	Optimum design (step 5a)	Global optimum (step 5b)
Locations	Location 5	Location 5		
			Location 8	
	Location 10	Location 10	Location 10	Location 10
		Location 13	Location 13	Location 13
			Location 17	Location 17
	Location 18	Location 18		
				Location 21
	Location 25	Location 25	Location 25	
				Location 27
	Location 31	Location 31	Location 31	Location 31
Location 32	Location 32	Location 32	Location 32	
Overall preference score	61	63	64	66
Difference	-	3%	5%	7%
			change of 2 other locations as well	change of 3 locations

The results of this pilot study have also been presented in [Figure 5.40](#). The *best alternative* for this pilot was the *global optimum* and this alternative was accepted by the stakeholders as the final outcome. It must be noted, that in this pilot less interventions were possible (to add or remove a location) which partly influenced the amount of added value could be achieved. This alternative *global optimum* has an overall preference score of 66 (PFM algorithm) compared to the overall preference score of 61 for the current situation. The added value therefore is 5, more than twice the added value than the current process.

This means that PAS can also be successfully used in a different type of organization for a different type of problem. In comparison to Oracle's current scorecard process, PAS performs better than the original. In this pilot, it was possible to achieve a better result with the optimization tool (step 5b) than with the PAS design (step 5a), and the stakeholders accepted that result.

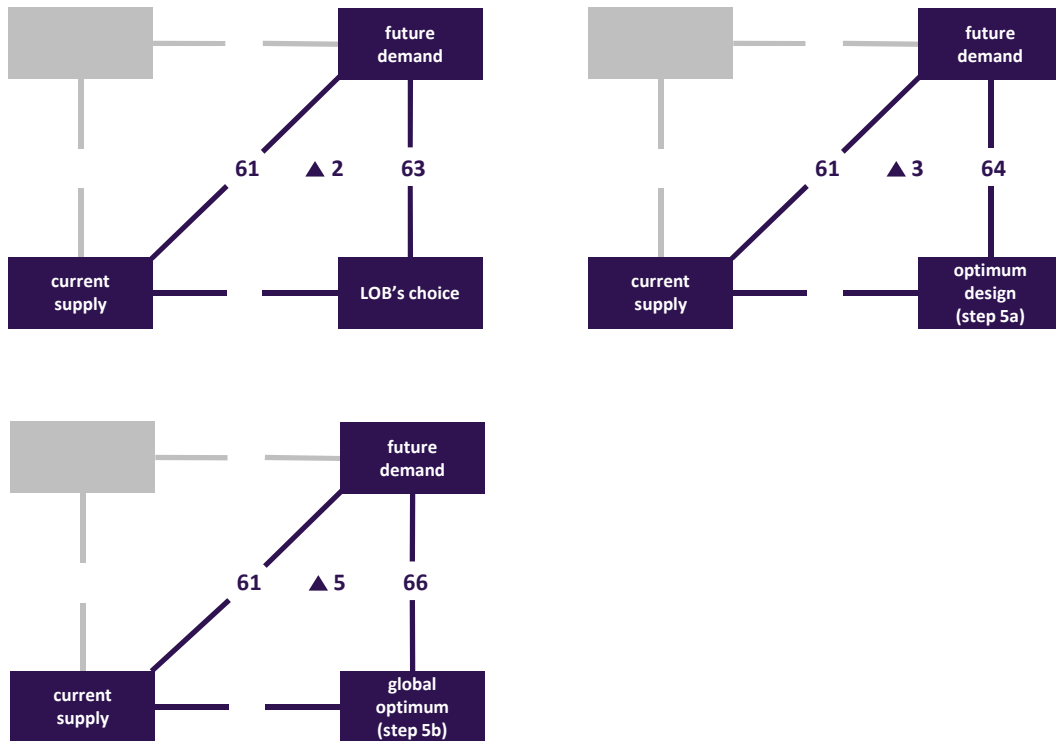

FIG. 5.40 PFM overall preference scores current situation and optimum design (step 5a) and global optimum (step 5b) as well as added value office locations Note adapted from De Jonge, et al., 2009, p. 36, Van der Zwart et al., 2009, p. 3, Den Heijer, 2011, p. xv.

The uniqueness of this pilot made it possible to compare the PAS results with their current decision making process (Phase I in **Figure 5.38**). This pilot study also gives an indication that PAS and especially the use of the curves, to express demand, reflects the stakeholders preferences better than the current process. This can be concluded based on the LOB's choice and the comparison rankings that De Visser made (see **Figure 5.41**). De Visser looked at the rankings instead of an overall score because the original study resulted in a ranking instead of a score (De Visser, 2016).

The comparison between the original ranking and PAS showed that roughly two third of the top-15 locations in the original study returns in the top-15 of the PAS outcome. Moreover, the chosen location 13 moved from place 17 in the original ranking to place 4 in the PAS ranking (in **Figure 5.41** this is the comparison between study 5 and 1). The chosen location is the second most preferred location that is not included in the current portfolio. This is an initial indicator that the PAS model

quite closely reflects the stakeholders' preferences in a more accurate way than the original scorecard procedure (De Visser, 2016).

study type	original study				PAS
	A. effect of different criteria		C. effect of change of weight stakeholder		
		B. effect of weighted average to original	D. effect of the use of preference curves		
study number	1	2	3	4	5
number of criteria	39	22	22	22	22
calculation	procedure scorecard	procedure scorecard	weighed average	weighed average	PAS
weights	original	original	original	new	new
position chosen location (ranking)	17	13	13	10	4
difference w.r.t. previous ranking		4	0	3	6
difference w.r.t. ranking 1			4	7	13

FIG. 5.41 Comparison PAS and original scorecard study Note adapted from de Visser, 2016, p. 75

It must be noted that the use of the PAS curves was not the only change compared to the current scorecard process. Therefore other factors also influenced the better representation. In order to make a comparison De Visser (2016) made the comparison as is shown above. The changes were:

- A The amount of criteria decreased (from study 1 to 2) and resulted in a higher ranking of the chosen location of 4 places;
- B The way the overall score was calculated changed (from study 2 to 3) and resulted in the same ranking of the chosen location;
- c In study 4 each criterion received a weight while in the original study the weights were given to a set of criteria (from study 3 to 4). This resulted in a higher ranking of the chosen location of 3 places;
- D In study 5 the preference curves were new. This resulted in a higher ranking of the chosen location of 6 places (De Visser, 2016).

Having that said, the chosen location scored better in phase I⁵² with PAS than with the current scorecard process, a higher ranking of 13 places. A difference of 13 places (between position 17 and 4) in PAS equals a location preference scores of 68 (ranking 4) and 53 (ranking 17) (De Visser, 2016).

⁵² In phase II of Oracle's current process the chosen location received a higher position

5.4 Pilot study comparison and conclusion

The PAS is tested in three pilot studies to determine if the stakeholders are able to successfully perform PAS. All pilot studies show that the stakeholders were able to perform each step of PAS, including the new step 2 (determining preferences) and step 5a (design alternatives). The stakeholders were able to design an alternative CRE portfolio with a higher overall preference than in the current situation. This means that they were able to better align their CRE portfolio to the organization. The pilots respectively have an added value, expressed in an overall preference score, of 54, 17 and 3 (see [Table 5.5](#)). In step 6 all stakeholders accepted that alternative as the final outcome.

TABLE 5.5 Pilot comparison achieved added value alternative CRE portfolio design (step 5a)

Results (based on PFM algorithm)	1 st pilot study Food facilities	2 nd pilot study Lecture halls	3 rd pilot study office location
Overall preference score current portfolio	41	53	61
Overall preference score alternative design	95	70	64
Added value	54	17	3

In two pilots an alternative CRE portfolio has been generated with an optimization tool (see [Table 5.6](#)). In the Oracle pilot, the brute force approach was able to generate an alternative with a higher overall preference score (66) than the current situation (61) and the design (64). As a reminder, the overall preference score is in between 0 and 100. In the TU Delft food facilities pilot, the search algorithm was not able to generate a *feasible alternative* with a higher overall preference score.

The Oracle pilot also showed that PAS performed better than their current location decision making process. The overall preference score of their chosen alternative was 63, while the optimization tool was able to achieve an overall preference score of 66. This was due to the fact that in the current process one new location was added to the portfolio, while in the PAS the total EMEA portfolio has been optimized. This means that more than one location was changed.

TABLE 5.6 Pilot comparison achieved added value alternative CRE portfolio design generated by optimization tool (step 5a&b)

Results (based on PFM algorithm)	1 st pilot study food facilities	3 rd pilot study Office location
Overall preference score current portfolio (a)	41	61
Overall preference score alternative design (step 5a) (b)	95	64
Overall preference score alternative optimization tool (step 5b) (c)	no feasible alternatives	66
Added value (maximum)	54 (b-a)	5 (c-a)

PAS improved the representation of the stakeholders preferences compared to Oracle’s current scorecard system due to the use of preference curves.

The three pilot studies show that the PAS can be applied in different organizations, and for different types of problems with a different level of complexity (see [Table 5.7](#)). In comparison, the first two pilots were more complex because more stakeholders were involved and more interventions were possible. Applying this approach to multiple context-dependent cases has yield more valuable results than just applying it to one case. PAS is generic, it can be argued based on the results that it can be used for a wide range of real estate portfolio types.

TABLE 5.7 Pilot study comparison on characteristics

Characteristics:	1 st pilot study food facilities	2 nd pilot study lecture halls	3 rd pilot study office location
New or existing case	New	New	Existing
Type of problem	allocation off on campus	allocation of lecture halls on campus	location decision making
CRE strategy	the ambition to create a living campus is to maximize the function of the campus as a place to meet each other and work together	fit changing educational demand	the new location (hub) needs to attract millennials and be attractive to native English speakers
# Stakeholders	6	6	2
# Decision variables	17	28	22
# Design constraints	6	5	4
# Interventions	5	11	1
# Objects	14	18	32

6 PAS stakeholders & activities to achieve alignment

chapter 2	CRE alignment state of the art and scientific gap
-----------	---

**Preference-based Accommodation Strategy (PAS)
design and decision approach**

Developing PAS		Testing PAS			Evaluating PAS
chapter 3	chapter 4	chapter 5	chapter 6	chapter 7	chapter 8
fifteen basic concepts and definitions from decision, design and management theory	2nd procedural rationality	steps			steps
	3rd structural rationality		stakeholders & activities		stakeholders & activities
	1st substantive rationality			model	model

chapter 9	Reflecting upon PAS
-----------	---------------------

chapter 10	Conclusions and recommendations
------------	---------------------------------

6 PAS stakeholders & activities to achieve alignment

PAS consists of three main components; steps, stakeholders & activities, and mathematical models, as explained in chapter 4. In this chapter, the *stakeholders & activities* are the focal point (see [Figure 6.1](#)). By explaining the interactive design process in detail, the reader understands how the stakeholders perform the activities to achieve alignment between the organization and the corporate real estate portfolio.

The stakeholders & activities are displayed in the left column of the flowchart in [Figure 6.2](#). There, the stakeholders that are involved are divided in three types: the responsible management (RM), the stakeholders (S) and the facilitator and systems engineer (F & SE). They need to perform two types of *activities*: interviews and workshops. In the activity *interviews*, the stakeholders perform steps 1 to 4. In the activity *workshops*, the stakeholders perform step 5. They design an alternative corporate real estate portfolio and continue designing other alternatives until they mutually agree that the best possible alternative has been made. The activities are finished when, in the last *interview*, each stakeholder individually confirms the selection of the best alternative.

The *results* of the three pilots have been discussed in chapter 5 including the final input the stakeholders have given in the interviews for steps 1 to 4. The best alternative the stakeholders have chosen in step 6 was also presented. This alternative was designed interactively and iteratively in the *workshops* in step 5. However, *how* the stakeholders have designed this alternative has not yet been explained. Since, interactively and iteratively designing alternatives in the mathematical models is a major component of PAS this design process is explained in this chapter. This chapter shows the interfaces that the stakeholders can use when designing alternatives including instructions on how to navigate the model.

This chapter presents the pilots as follows:

- Pilot study 1: TU Delft's food facilities in paragraph 6.1;
- Pilot study 2: TU Delft's lecture halls in paragraph 6.2;
- Pilot study 3: Oracle's office locations in paragraph;
- And the pilot study comparison and conclusion in paragraph 6.4.

For each pilot study, in the first subparagraph, the *design interfaces* that the stakeholders have at their disposal, are explained. In the second subparagraph, the stakeholders workshop set up is discussed in which they use the interface to design alternatives. Lastly, in the third subparagraph, the iterative process is discussed. The iteration takes place between step 5 (designiWng alternatives) and step 1 to 4 (variables, curves, weights and constraints).

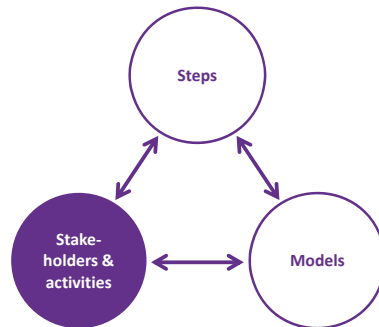

FIG. 6.1 Focus on PAS component stakeholders & activities Note adapted Arkesteijn et al., 2017, p. 245

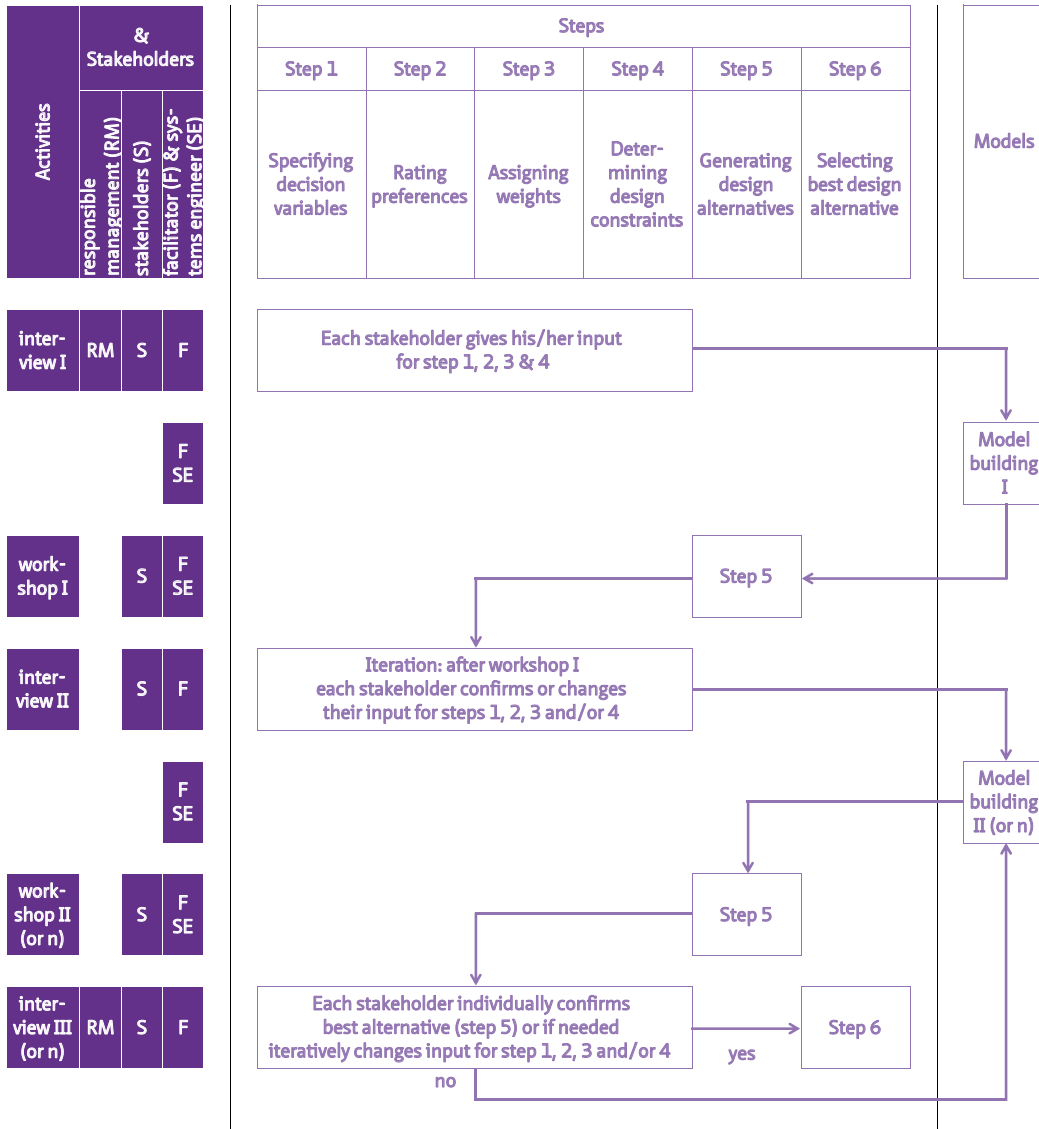

FIG. 6.2 Flowchart of PAS; emphasis on stakeholders & activities Note adapted Arkesteijn et al., 2017, p. 248

6.1 Pilot study 1: TU Delft's food facilities

This paragraph focuses on the interfaces the stakeholders had available in the pilot study. In chapter 5, based on Arkesteijn et al. (2017) the results of the pilot study have been presented. This means that in this paragraph some explanations are based on this paper and chapter 5.

6.1.1 Interfaces to design alternatives (step 5)

The main objective in the workshop for step 5 (designing alternatives) is to maximize the overall preference score. In this pilot the stakeholders designed the alternatives. The stakeholders in this pilot have been able to design an alternative with an *overall preference score* of 96 as we have seen in paragraph 5.1.6.

The stakeholders have four design interfaces available to work with and these will be discussed subsequently. The first interface is the primary design interface, showing the map of the TU Delft with all the food facilities. The second interface shows detailed information per food facility and enables the stakeholders to select interventions for this food facility. Selecting interventions changes the first interface, as will be shown. The third part of the interface is a detailed table the stakeholders can use when selecting interventions. The fourth interface is an input interface that shows all preference curves for each criterion, enriched with design information. Besides the main design interfaces the stakeholders received three additional design tools, which they could use in their design process. In each part, the interface will be described and a reflection will be given whether or not the interface has been used during the workshops.

Main design interface

The main design interface is displayed in [Figure 6.3](#). The model's main interface is the map of the TU Delft showing the current situation of the portfolio food facilities, consisting of 11 restaurants and 3 coffee corners with an *overall preference score* of 44 (out of 100).

Task 1 and 3 Current match; generating future models

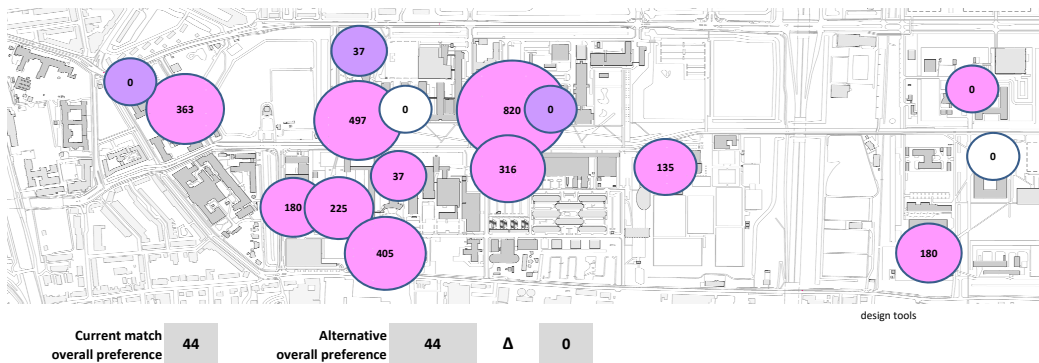

FIG. 6.3 Main design interface Note from Arkesteijn et al., 2017, p. 250

This color of the circles indicated the type of facility; purple indicates coffee corners and pink restaurants either for lunch and/or dinner, with or without coffee corner. The size of the facility, expressed as amount of seats, is mentioned in the circle and the size of the circle represents this.

In the workshops the stakeholders could select each food facility (by clicking on the circle) and press the button 'show location data' which gives them second interface. With the button 'show location', it is possible to return to the map. When a certain intervention is chosen, the overall preference score for this design alternative is shown as well as its add value (indicated with the triangle). After the stakeholders had chosen a set of interventions (see 2nd interface) for the food facilities of their choosing, they generated a design alternative (see Figure 6.4). They interactively saw the overall preference score for this design alternative during this design process, as well as the difference in preference score between the designed alternative and the current (zero) alternative. They did not only see the overall preference score but were also able to see the preference scores for each specific variable (see third interface). The decision makers generated several design alternatives in order to search for the highest possible overall preference.

This interface was most used during the workshops.

Task 1 and 3 Current match; generating future models

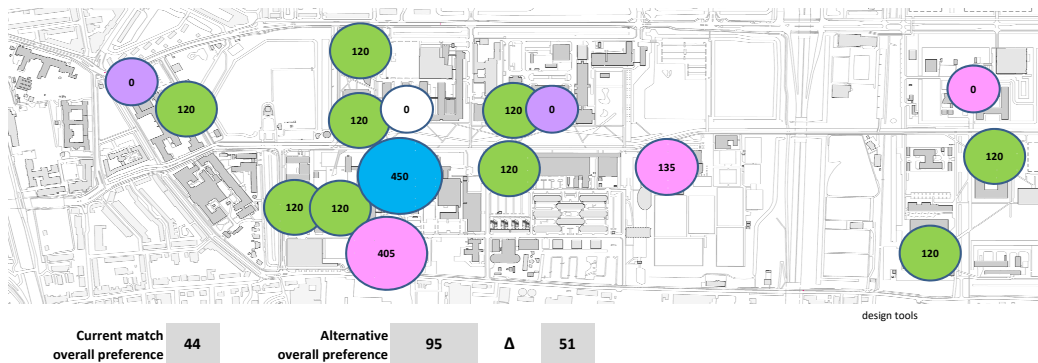

FIG. 6.4 Main design interface displaying the chosen alternative Note from Arkesteijn et al., 2017, p. 255

Intervention interface

The intervention interface is a dialog window which appears after a certain location is selected. In this interface several benchmark data for this facility (see [Figure 6.5 a](#)) is displayed. The benchmark data for instance shows administrative information, like the building number, but also amount of meter per user and technical state. It contains a pull down menu which enables them to select an intervention for this specific facility (see [Figure 6.5 b](#)).

In this particular case the following types of interventions are identified:

- 1 Refrain from action;
- 2 Remove the food facility;
- 3 Convert the existing food facility to new concept *middle*, *large* or *faculty club*;
- 4 Create a new concept *middle*, *large* or *faculty club*;
- 5 Upgrade the existing food facility (add power outlets).

The new concept *middle* is a food facility exclusively intended for lunch, while the new concept *large* is a food facility for lunch and dinner. It is good to note that, during the second workshop, the meaning of the concept *middle* changed. At first, in the concept *middle* cold only lunches would be served, while later the FMRE department partly shifted this into serving both cold and warm lunches. This means that the concept *middle* was not clear enough, and that is why in paragraph 5.1.6 the final alternative was accepted under the condition that concept *middle* would include warm meals as well. Because the new concepts are different from the current

food facilities, they have been given a different name. When a certain intervention is chosen, the color of the food facility immediately changes to give visual feedback about the type of facility. When the food facility is removed (intervention 2), the color becomes white, when a food facility is converted (intervention 3) it becomes green, and when a new concept is added it becomes blue. In the pull down menu for each food facility, only the feasible interventions were shown.

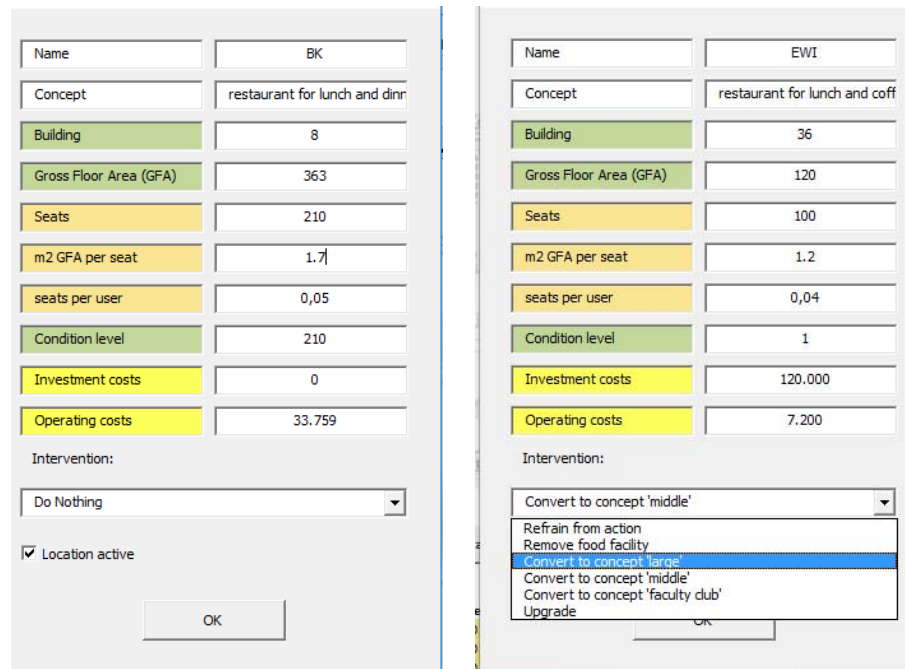

FIG. 6.5 Intervention interface (a) on the left without pull down menu and (b) on the right with pull down menu open

In a presentation the stakeholders were informed about *how* exactly the interventions would influence the preference scores. A new or converted food facility *middle* would have 100 places and 120 m² g.f.a., while a food facility *large* would have 300 places and 450 m² g.f.a. The decision makers were informed about the values each decision variable would receive when a certain intervention was chosen. An intervention of a food facility to concept *middle* and *large* means: the facility is located on the ground floor near the main entrance, with one door in between the main entrance and the facility, 1 minute average walking time from entrance to the facility, 40% of the places have sufficient acoustics and a preference score of 100 for coziness and ambience.

The investment costs of a new facility *large* is 1500 euro per g.f.a. and 90 euro per g.f.a. operating expenses and for a new facility *middle* or *faculty club* respectively 1200 euro per g.f.a. and 72 euro per g.f.a. A conversion towards concept *large* or *middle* has investment costs of 1000 euro per g.f.a. and 60 euro per g.f.a. operating expenses.

Interface with design information per stakeholder

Below, the two interfaces are shown with detailed design information. This detailed information is directly linked to each of the specific stakeholders. In **Figure 6.6** design information per stakeholder specifies each of the criteria separately and in **Figure 6.7** design information per stakeholder about their constraint(s) is given. This design information gives the stakeholders guidance (which intervention to select) and shows them the changes in preference score as a result of a (set of) interventions.

The following information is presented in the abovementioned figure.

- In the column weighted score: the overall preference score of the designed alternative is given based on the preferences (curves), stakeholder weights;
- Max. score: indicates the score that an alternative can maximally receive for a specific stakeholder;
- Delta: indicates the amount preference points that another alternative be can earn;
- Value: this is the (physical) value that the designed alternative scores. This value is converted to preference score via the curves;
- Unit: this is the unit in which the value is expressed;
- Score this is the preference score of the designed alternative. This score is converted from the value via the curves;
- Weight: this is the weight that a specific stakeholder gives to his/her criteria.

During the workshops the systems engineers observed that the stakeholders did not use all of the information that was provided in **Figure 6.6**. The column 'delta' was most used as guidance for opportunities to raise the overall preference score. This delta showed the stakeholder which criterion had the lowest preference score and therefore, also could be improved most. The criterion per stakeholder that had the most potential to add value is marked⁵³. In the design process, this information guides the stakeholders to appropriate interventions.

⁵³ The model that was used in the workshops with the stakeholders was interactive, which means that the decision variable with the highest delta per stakeholder differed during the design process. The marked cells therefore are only added in this figure.





stakeholders	design variabelen	weighted score	max. score	delta	value	unit	score	weight
	Maximum walking time from a faculty building to a food fac	15	35	20	7	min	42	35%
	Maximum walking time from a faculty building to a food fac	0	5	5	673.263	min	0	5%
	Percentage of places in all food facilities which can be used	4	20	16	11	%	22	20%
	Capaciteit informele plekken	0	0	0	1.300	places	0	0%
	Percentage of places in the facilities having sufficient acoust	4	20	16	4	%	22	20%
	Average preference rating on ambience for the food facilitie	12	20	8	62	-	60	20%
	Average vertical location of food facility [floors]	11	20	9	0,54	floors	57	20%
	Amount of doors between outside and the food facility [doc	6	10	4	1,54	doors	58	10%
	Average walking time from an entrance to a food facility [m	15	15	0	0	min	100	15%
	Percentage of places in all food facilities which can be used	0	15	15	11	%	3	15%
	Maximum walking time from a faculty building to a food fac	0	30	30	7	min	0	30%
	Maximum walking time from a faculty building to a food fac	0	10	10	673.263	min	0	10%
	Maximum walking time from a faculty building to a food fac	0	10	10	7	min	0	10%
	Maximum walking time from a faculty building to a food fac	0	25	25	673.263	min	0	25%
	Percentage of food facilities labelled diverse [%]	17	25	8	69	%	69	25%
	Average preference rating on coziness for the food facilities	19	40	21	48	-	48	40%
	Average preference rating on find-ability of the food facilitie	37	50	13	74	-	74	50%
	Percentage of places in all food facilities which can be used	15	50	35	11	%	29	50%

FIG. 6.6 Design information per stakeholder and per design variable

In **Figure 6.7** the design information per stakeholder per constraints is given. If a certain constraint was not met this is indicated in this figure (constraint turns red).



Constraints			
Stakeholders	Decision variables	value	unit
	Accessibility restaurant concept dinner	100	%
	Accessibility restaurant concept lunch	100	%
	Accessibility concept fc	100	%
	User satisfaction	98	-
	Investment costs	1.850.000	€
	Operating costs	93.240	€/jr

FIG. 6.7 Design information per stakeholder and per design variable

This figure was rarely used during the workshop by the stakeholders. The facilitator and system engineer were the ones that checked this information but only when an alternative was designed that was very promising.

Input interfaces

In the model each of the stakeholders had their own tab where all information as collected in step 1 to 4 was displayed (see **Figure 6.9**). The visualization of the preference curve was enriched during the workshops by adding two points on the

curves, as can be seen in [Figure 6.8](#). The preference score for the current situation is indicated with a green triangle and the alternative with a red square. In this particular example the walking distance was reduced from 4 to 2 minutes, which corresponds with a preference score of 60 for the students.

In the workshops the stakeholders did not go back to their input screen to look at the position of the current and future situation.

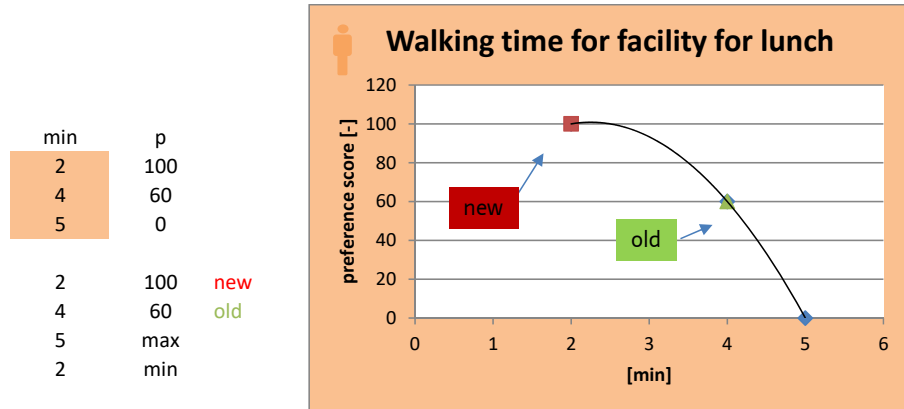

FIG. 6.8 Enriched input interface

PAS interfaces and DAS

In this first pilot, the interfaces occasionally give an explicit connection to DAS. In this case the visualization of DAS by (Den Heijer, 2011) is in the bottom left corner. In the overview per stakeholder ([Figure 6.9](#)), DAS was shown and it was indicated that in that particular interface the first task needed to be performed (assessing the current portfolio). In the main interface the heading refers to DAS indicating 'Task 1 and 3: current match and generating future models (see [Figure 6.3](#) and [Figure 6.4](#)).

Works council

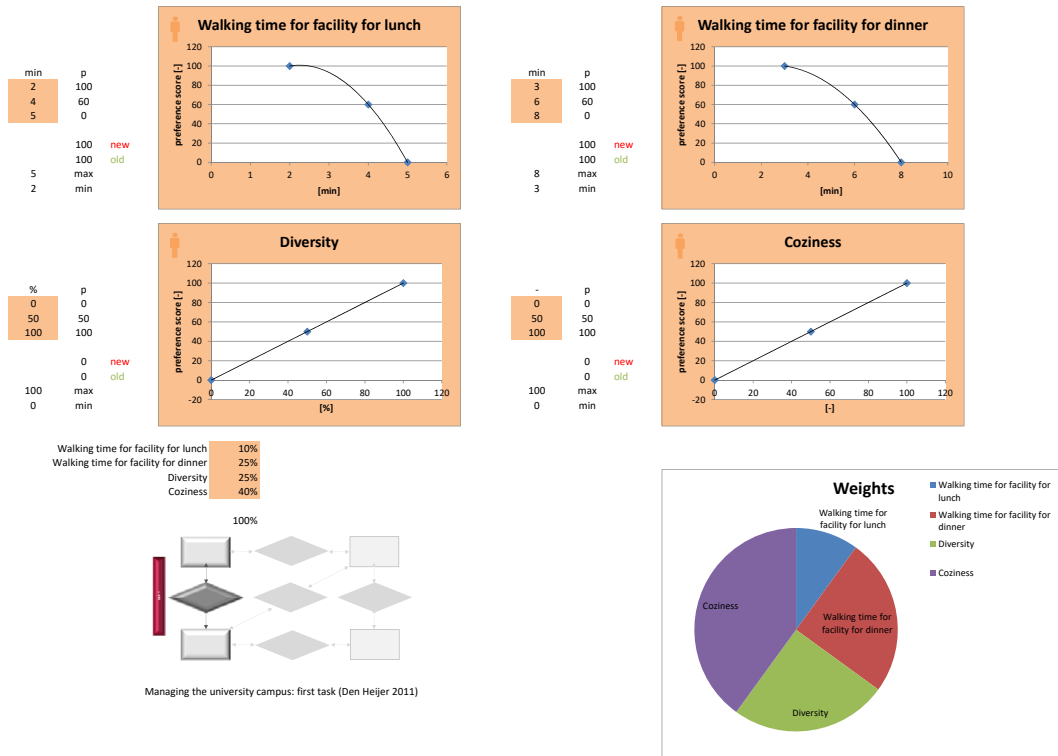

FIG. 6.9 Input interface with overview per stakeholder of step 1 to 3

Additional tools

In the workshops three different additional tools were available:

- 1 A design tool that displayed whether or not food facilities were available within the desired walking distance;
- 2 A benchmark of the current food facilities;
- 3 A reference model to support stakeholders to select relevant criteria given their objectives.

It turned out that these design tools were not or hardly used by the stakeholders therefore, they are displayed in appendix E.

6.1.2 Workshops to design alternatives (step 5)

The two workshops had different objectives, as explained in paragraph 4.4. In this pilot, the stakeholders were divided into two smaller groups to design alternatives from the perspective of only one of the stakeholders at the time. Each group was assisted by a facilitator or system engineer who operated the computer model. The assignment objective of this workshop was to familiarize the stakeholders with (a) the model itself, (b) whether the systems engineer had interpreted their input from the first steps correctly, (c) the model's performance and its reliability, (d) the criteria other stakeholders listed and especially (e) the effects the interventions had on their own criteria. The feedback during the session is used by the system engineer to improve the model in case of misinterpretations, and by the stakeholders in their second interview. In this interview the insights from this workshop are used to change their individual input, if needed. In this session many alternatives were made designed?.

In each of the workshops each stakeholder received a print out of the slides and a log containing their own information.

In the second workshop the stakeholders received two assignments. For the first, the stakeholders were divided into two groups and were asked to design an alternative with the highest overall preference score. In this workshop each group was assisted by a facilitator or system engineer (see [Figure 6.10](#)). For the second, the stakeholders compared the results of the two groups, and together made one more iteration to design the alternative with the highest overall preference score that all of them agreed upon. In [Table 6.1](#) an overview of these alternatives are presented and below the alternatives are presented [Figure 6.11](#).



FIG. 6.10 Impression second workshop

TABLE 6.1 Best alternatives as designed in the second workshop

Alternative	Overall preference score	Investment costs	Capacity
Current portfolio food facilities	43	-	3.491
Alternative 1 Group 1	96	2.282.000	2.914
Alternative 2 Group 2	93	2.215.000	2.226
Alternative 3 Entire group	95	1.850.000	2.070

Task 1 and 3 Current match; alternative 1

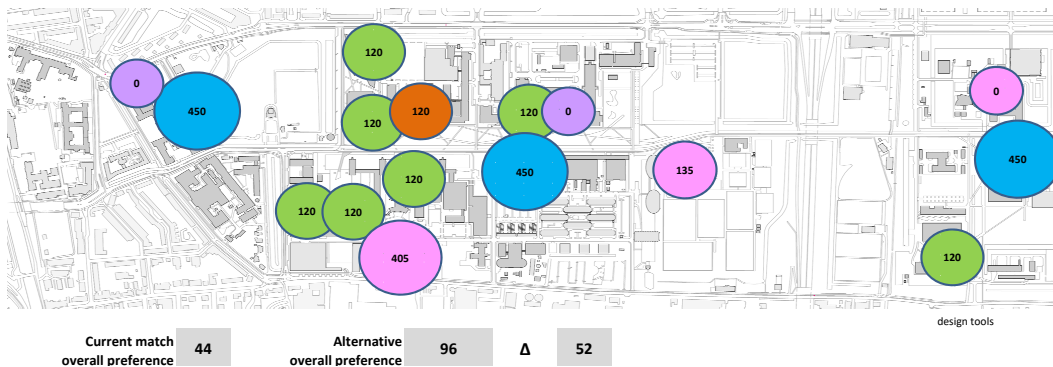

FIG. 6.11 Two alternative designs (alternative 1 on top, alternative 2 at the bottom)

6.1.3 Iterating between alternatives (step 5) and requirements (steps 1 to 4)⁵⁴

The participants were required to design alternatives in step 5. In the workshops, the starting point was the current portfolio ... with the overall performance score based on the weighted sum of all the preference scores. The objective was to iteratively design an alternative with the highest possible overall preference score by modifying both the real estate objects in the portfolio and, if necessary, alter the criteria, curves, weights or design constraints from step 1 to 4.

⁵⁴ Paragraph 6.1.3 was published as section 6.2.1 in Arkesteijn et al., (2017, pp. 257-258). The cited text is displayed in purple, added text in black. Figure numbers have been altered to suit the thesis

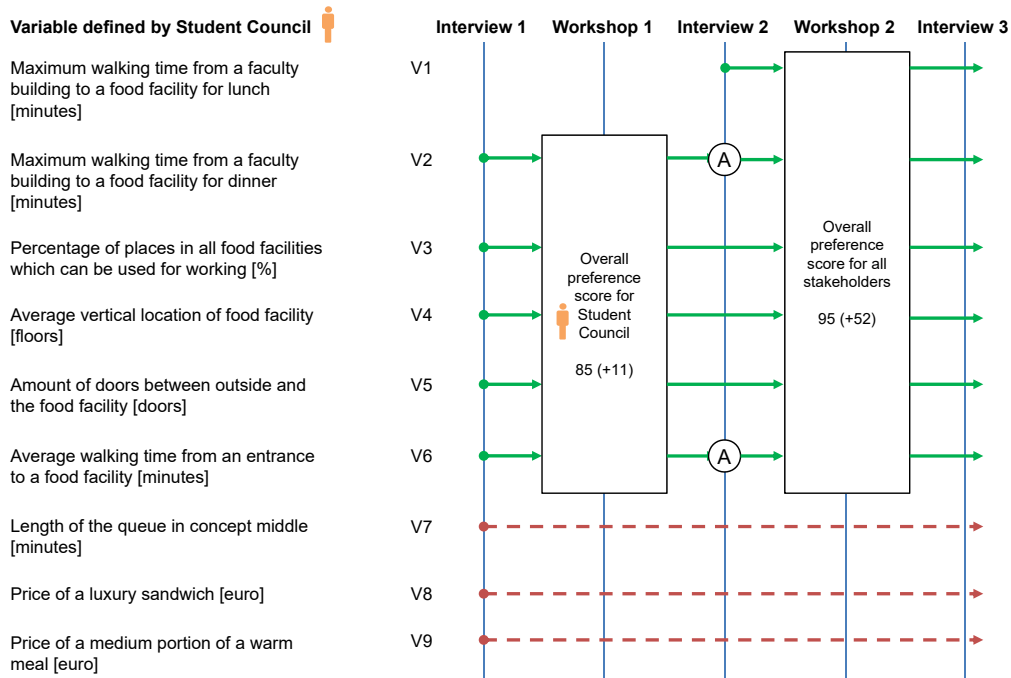

FIG. 6.12 Iteration between interviews (requirements) and workshops (alternatives). A green arrow means that the criterion was incorporated in the model; a red arrow means that it was not incorporated in the model. A box with the letter "A" in it means that a criterion was adjusted in an interview.

In the first workshop the participants were divided into groups and optimized solely based on their own variables, while in the second workshop the stakeholders optimized based on all criteria. Figure 6.12 shows that iterations were used during the workshop by demonstrating the development of the variables (V) given by the student council. They did not define any design constraints. two variables (V2 and V6) and added a new one (which is called V1). Three variables (not numbered) were mentioned in the first interview but not incorporated in the model. This stakeholder also changed the weights between the variables, both after the first and the second workshop.

What this demonstrates is that the feedback from design helps the users to better understand their input and to improve it if necessary. By doing so, the representation of their preferences in the model better depicts the actual situation. The use of such a learning process in the context of work practice and problem-solving is described by (Schön, 1987) as reflection in action.

6.2 Pilot study 2: TU Delft's lecture halls

This paragraph focuses on the interfaces the stakeholders had available in the pilot study. In chapter 5, based on Valks (2013) and Arkesteijn et al. (2015) the results of the pilot study have been presented. Valks (2013) built the model but the interfaces of the model have not been extensively reported on yet⁵⁵.

6.2.1 Interfaces to design alternatives (step 5)

The stakeholders have eight design interfaces available to generate alternative real estate portfolios. In this particular pilot, as explained in paragraph 5.2, a combination of preference based design and linear programming was used. The stakeholders expressed their demand similarly as in the first pilot using while linear programming was used to check whether or not a schedule was feasible. This meant that an extra step was necessary in the evaluation of a specific design alternative.

Main design interface

The main design interface is displayed in [Figure 6.13](#). The model's main interface is the map of the university showing the current situation of the portfolio lecture halls consisting of 18 lecture halls with an *overall preference score* of 58 (out of 100). On the map, the stakeholder can click on one of the icons representing a lecture hall to select it or he can opt to do a specific intervention in each of the lecture halls. Green lecture halls are currently active, which means that activities are scheduled in them. In lecture halls with a red icon, no activities are currently scheduled.

In this particular case, in contrary to the first pilot, two types of interventions are possible: real estate interventions (on the left hand side) and organizational interventions (on the right hand side; in Dutch 'Ingrepren Proces'). The interventions are explained in paragraph 5.2. The interventions are shown below the map so the stakeholder can apply the interventions directly to the entire portfolio without having to keep navigating through other interfaces. In this way the stakeholder can easily

⁵⁵ Valks as graduate student joint the project 'Strategic portfolio management' for the Facility Management and Real Estate of the TU Delft. The interfaces were designed jointly and were a continuation of the first pilot. In this pilot, the link between the DAS frame and the steps was made more explicit.

assess the impact of a specific intervention on a portfolio level before specifying and adjusting on an object level.

Below the interventions the overall preference score can be seen. The overall preference score is shown for each stakeholder separately as well as for all stakeholders (grey box). In each box the overall preference score for the current real estate portfolio is given (current match) and the overall preference score for the future real estate portfolio (future match) as well as the added value, indicated as delta. Each rectangle represents a different stakeholder. The stakeholders can see how well the alternative performs on their criteria and also shows the weight they have.

In this interface the stakeholders can also access additional information based on which step of DAS they are performing. All buttons lead to the same interface, but each button shows a different amount of information. In 'task 1 – assessing the current campus' only information with regard to the current situation is displayed. The user can see the current performance of the timetable on a number of indicators and the current performance on each user criterion. In 'task 2 – exploring changing demand' the user can implement a number of timetabling adjustments and see the impact on both the timetable and each user criterion. Both the current and the future match are displayed now. In 'task 3 – generating alternatives' the user can see all the available information.

The effects on the overall preference score are directly fed back at the bottom of the screen. If organizational interventions have been chosen, the stakeholder can again test the allocation and view the effects on the overall preference score and the effects on each criterion design information interface.

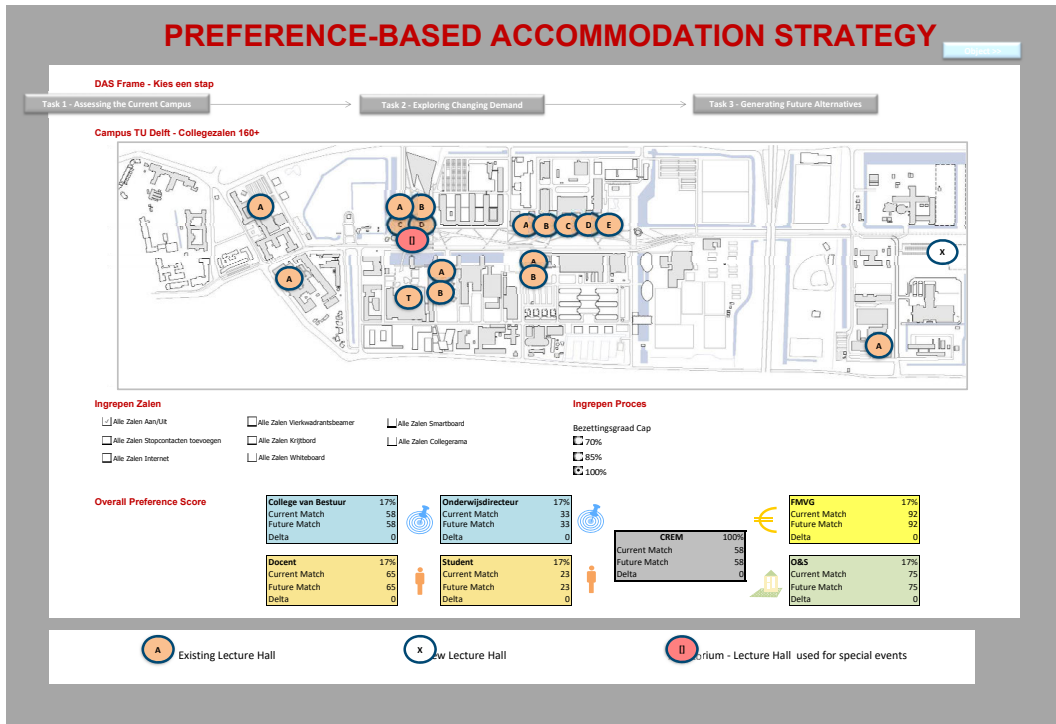

FIG. 6.13 Main design interface

Intervention interfaces for the lecture halls

The intervention interface appears after a certain location is selected in the main interface. In this interface several benchmark data for this facility (see Figure 6.14) is displayed. The benchmark data for instance shows administrative information, like the building number, but also amount of meter per user and technical state. It contains a pull down menu which enables them to select an intervention for this specific facility.

Informatie per zaal ✕

Aula Auditorium

Properties

Capacity

Construction year

Frequency rate (%)

Reality

Current Match

Future Design

Suitability (% of activities)

Current Match

Future Design



Interventions

Space active

Power sockets

Internet connectivity

Four quadrant beamer

Chalk board

Whiteboard

Interventions

SMARTboard

Collegerama

Seating arrangement

Standard Flexible furniture Flexible chairs

FIG. 6.14 Intervention interface

The following information can be found in **Figure 6.14**:

- Capacity – the amount of seats in the lecture hall;
- Construction year – the year in which the lecture hall was built;
- Frequency rate (%) – the amount of hours that the lecture hall is used as a percentage of the total hours that it is available:
 - Reality – the frequency rate as derived from the university’s timetable in the academic year 2012-13;
 - Current match – the frequency rate as calculated in PAS for the current match;
 - Future design – the frequency rate as calculated in PAS for the future design;
- Suitability (%) – the percentage of activities in the schedule for which the lecture hall is suitable; depends on the capacity and facilities in the lecture hall:

- Current match – the suitability percentage as calculated in PAS for the current match;
- Future design – the suitability percentage as calculated in PAS for the future design;
- Interventions – the possible interventions that can be done in a lecture hall. For each intervention the initial value shows what the status in the current match is.
 - Space active – the lecture hall operational and will thus be scheduled for activities;
 - Power sockets – 1 power socket per 2 students will be added to the lecture hall in order to support the use of electronic devices;
 - Internet connectivity – Wi-Fi access points will be added to the lecture hall to increase internet connectivity for students. (This is already present in almost all lecture halls);
 - Four-quadrant beamer – A four-quadrant beamer will be added to the lecture hall. Four-quadrant beamers make a four-screen projection possible. This is an innovation in engineering education that is meant to improve and replace the use of chalk boards;
 - Chalk board – A chalk board will be added to the lecture hall;
 - Whiteboard – Four whiteboards will be added to the lecture hall, which can be used by students to write questions on;
 - SMARTboard – A SMARTboard will be added to the lecture hall. A SMARTboard is an interactive whiteboard on which the teacher can write digitally;
 - Collegerama – A Collegerama set will be added to the lecture hall. Collegerama is a mobile recording apparatus that is used to record lectures;
 - Seating arrangement – The seating arrangement of the lecture hall can be set to flexible chairs, flexible chairs and tables or standard. The selection of a flexible arrangement reduces the capacity of the lecture hall, as these arrangements require more space per m².

Doing interventions in the lecture halls serves two purposes. Firstly, it improves the performance of the portfolio with regard to some of the stakeholders' preferences: for example the teaching staff's preference score will increase if more lecture halls include four-quadrant beamers. Secondly, it can improve the suitability of a lecture hall to accommodate an activity (see [Figure 6.19](#)). For each activity, the course coordinator can specify which criteria a lecture hall must fulfill (e.g. required capacity, presence of a four-quadrant beamer, flexible seating arrangement). If the suitability of lecture halls is improved, it is possible to make a schedule in which the allocation of lecture halls to activities better matches the stakeholder's preferences. Also, it might be possible to reduce the total amount of lecture halls needed to accommodate all activities.

Intervention interface for the timetable

At the top of the screen the stakeholders can select a step⁵⁶ from DAS that they wish to complete: assessing current demand, exploring changing demand or generating future alternatives. When the stakeholders click on one of these steps, a new interface opens. This interface is the same for each of the three steps; however, the information displayed for each of the steps is different. The use of this interface is described for each DAS step.

Step 1: Assessing the current campus

In step 1, the interface serves as an introduction to all the information for the stakeholders. On the first tab (**Figure 6.15**) an explanation is shown of the first DAS step and the CREM model. If a stakeholder wishes to view his criteria, he can navigate to a specific stakeholder by clicking on the icons in the CREM Model. Each stakeholder has an input interface in which their own criteria, curves, weights and design constraints are displayed (**Figure 6.22**). When the stakeholder clicks 'Determine', this interface closes and he returns to the main interface.

In the second tab (**Figure 6.16**), named portfolio level, the stakeholder can view the scope and the current performance of the timetable on a number of indicators: the amount of lecture halls in which activities are scheduled, the amount of activities scheduled, the average frequency, etc.; this is explained further during step 2. Also, the stakeholder can select for which education week a timetable simulation is made. By default this is the first week of the academic year, which is the busiest week (week 1.1). This education week is used to recalculate the current match, after which the stakeholder can proceed to the next DAS task.

In the third tab (**Figure 6.22**), the stakeholder is presented with an overview of the current performance on each stakeholder criterion. Per criterion the current preference score is shown, but also the weights per criterion and the current values of each criterion. Finally, in each tab there is an overview of the current preference scores for each stakeholder on the right.

⁵⁶ In this pilot in the interfaces and explanations the steps in DAS are sometimes referred to as tasks.

Step 2 - Exploring Changing Demand

DAS Frame
Portfolio Level
Match

START: KEUZE ROOSTER

Onderwijsweek (Q1 2012/2013)

Week 1.1
 Week 1.2
 Week 1.3

[Update Current Match](#)

PORTFOLIO INFORMATIE

	Current Demand	Future Demand		Current Supply	Future Supply
Activiteiten	48	48	Collegezalen	17	17
Totale Vraag (uren)	496	496	Bezettingsgraad (%)	73	65
Totaal Ingeroosterd (uren)	492	496	Geschiktheid (% van aantal activ)	49	49
Geschiktheid (% van zalen)	8.3	8.3			

[Zie Objecten](#)
 [Test Allocatie](#)

SCENARIO PLANNING

1. Roostering
 2. Onderwijsvernieuwing
 3. Studentaantallen
 4. Verhuizing THW
 5. Dagrooster

Eigen faculteit (5 min)
 Bacheloronderwijs
 100 %
 Verhuizing naar Campus Zuid
 Lunchuur inroosteren
 Avonduren inroosteren

Cluster (10 min)
 Campus (15 min)

[Sync Scenario's](#)
 [Update Future Match](#)

Design

College van Bestuur

Gewicht 17 %
 Current Match 58
 Future Match 56

Onderwijsdirecteuren

Gewicht 17 %
 Current Match 33
 Future Match 46

FMVG

Gewicht 17 %
 Current Match 92
 Future Match 91

Student

Gewicht 17 %
 Current Match 23
 Future Match 24

Docent

Gewicht 17 %
 Current Match 65
 Future Match 64

Onderwijs & Studentenzaken

Gewicht 17 %
 Current Match 75
 Future Match 82

CM	FM	Delta
58	61	3

[Determine](#)

FIG. 6.15 Interface step 1 assessing the current campus; DAS frame

Step 2: Exploring changing demand

If the stakeholders select the second DAS step, 'Exploring changing demand' in the main interface, the timetable interface opens on the second tab, 'portfolio level'. No additional information is available to the stakeholder. In all parts of the interface, the performance of the future design is shown next to the current match. Because no interventions are done, the performance is exactly the same in all aspects. In the tab 'portfolio level' the stakeholders can explore the changing demand by making amendments to the way activities are scheduled at the university and assessing the impact on a number of indicators (see [Figure 6.16](#)).

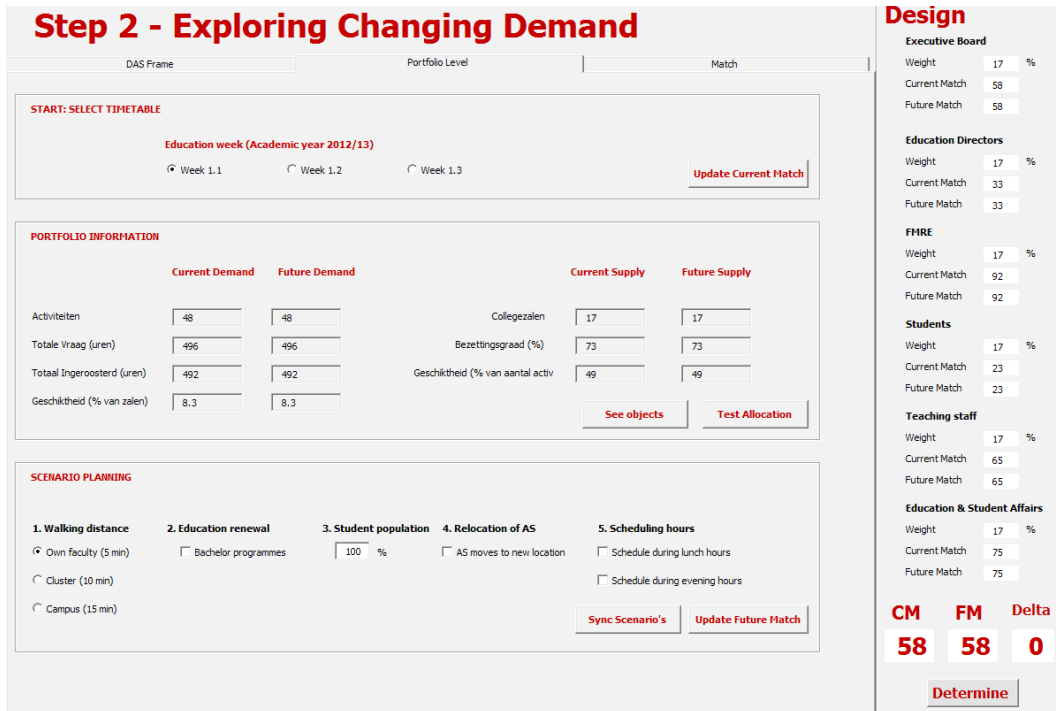

FIG. 6.16 Intervention interface step 2 exploring changing demand; portfolio level showing current situation

The indicators are the following:

- Demand (also referred to as requirements):
 - Activities: the total amount of activities defined. In this model activities are aggregated at the level of educational programs. For example, the first semester of the first year of the Bachelor program of Life Science and Technology is an activity;
 - Total demand (hours): the total amount of hours that is demanded by each activity;
 - Total scheduled (hours): the total amount of hours that is scheduled by the scheduling programmer. Ideally, this amount is equal to the total demand. In order to increase the amount, the amount of active lecture halls needs to be increased or the suitability of the lecture halls needs to be increased;
 - Suitability (amount of lecture halls): the suitability shows how many lecture halls are on average suitable to host an activity. The lower this number is, the more important it is to focus on improving the suitability of lecture halls;

- Supply (also referred to as (design) alternative):
 - Lecture halls: The total amount of lecture halls in which activities can be scheduled;
 - Frequency rate: The amount of hours in which activities are scheduled as a percentage of the total hours that the lecture halls are available;
 - Suitability (% of activities): the suitability shows the average percentage of activities that are suitable for each lecture hall;
- The user can assess design a scenario with the variables in the ‘scenario planning’ box, which are:
 - Walking distance: the allocation program determines that an allocation to a lecture hall can or cannot be made based on a predetermined walking distance. The walking distance can be increased (to 10 or 15 minutes) in order to increase the amount of suitable lecture halls for an activity;
 - Education renewal: the education renewal is an ongoing process in which the university expects that different education programs will reduce their amount of large-scale lectures in favor for other types of education, such as project-based education or instructions in classrooms. Applying the education renewal will lead to a 20% reduction of education activities;
 - Student population: the student population is a variable that is subject to change continuously. The stakeholder can adjust the amount of students by filling in a percentage of the current population (for example 120%). This percentage is then applied proportionally over all existing activities;
 - Relocation of Applied Sciences: One of the faculties is in the process of being relocated to a different part of the campus. The stakeholder can move the faculty, and thus all of the activities related to the faculty, to its new location. On the new location there is a fictive lecture hall that can be made active and to which facilities can be added;
 - Scheduling hours: The stakeholder can make it possible to schedule lectures during the lunch hour or in two extra evening hours, aside from the regular scheduling hours. This increases the time to schedule activities in.

In **Figure 6.17**, for instance the stakeholders selected to include the lunch hour in the schedule. By testing the allocation the stakeholder can immediately see what the effects of this scenario are for the portfolio. The amount of scheduled hours has risen from 492 to 496 and the occupation rate of the lecture halls has fallen from 73% to 65%. If he wishes to see how the allocation affects individual activities or lecture halls, he can click the button ‘see Objects’ to go to an interface that shows the effects of the allocation on each object (**Figure 6.19**). In this example, shows that the *overall preference score* increased from 58 to 61. The stakeholders can see the effects on the overall preference of each stakeholder individually, but not the effects per criteria. This can be seen in the next interface.

Step 2 - Exploring Changing Demand

DAS Frame
Portfolio Level
Match

START: KEUZE ROOSTER

Onderwijsweek (Q1 2012/2013)

Week 1.1
 Week 1.2
 Week 1.3
 Update Current Match

PORTFOLIO INFORMATIE

	Current Demand	Future Demand		Current Supply	Future Supply
Activiteiten	<input type="text" value="48"/>	<input type="text" value="48"/>	Collegezalen	<input type="text" value="17"/>	<input type="text" value="17"/>
Totale Vraag (uren)	<input type="text" value="496"/>	<input type="text" value="496"/>	Bezettingsgraad (%)	<input style="border: 2px solid red;" type="text" value="73"/>	<input style="border: 2px solid red;" type="text" value="65"/>
Totaal Ingeroosterd (uren)	<input style="border: 2px solid red;" type="text" value="492"/>	<input style="border: 2px solid red;" type="text" value="496"/>	Geschiktheid (% van aantal activ)	<input type="text" value="49"/>	<input type="text" value="49"/>
Geschiktheid (% van zalen)	<input type="text" value="8.3"/>	<input type="text" value="8.3"/>			

Zie Objecten
Test Allocatie

SCENARIO PLANNING

1. Roostering	2. Onderwijsvernieuwing	3. Studentaantallen	4. Verhuizing THW	5. Dagrooster
<input checked="" type="radio"/> Eigen faculteit (5 min)	<input type="checkbox"/> Bacheloronderwijs	<input type="text" value="100"/> %	<input type="checkbox"/> Verhuizing naar Campus Zuid	<input checked="" style="border: 2px solid red;" type="checkbox"/> Lunchuur inroosteren
<input type="radio"/> Cluster (10 min)				<input type="checkbox"/> Avonduren inroosteren
<input type="radio"/> Campus (15 min)				

Sync Scenario's
Update Future Match

CM	FM	Delta
58	61	3

Determine

Design

College van Bestuur

Gewicht 17 %

Current Match 58

Future Match 56

Onderwijsdirecteuren

Gewicht 17 %

Current Match 33

Future Match 46

FHVG

Gewicht 17 %

Current Match 92

Future Match 91

Student

Gewicht 17 %

Current Match 23

Future Match 24

Docent

Gewicht 17 %

Current Match 65

Future Match 64

Onderwijs & Studentenzaken

Gewicht 17 %

Current Match 75

Future Match 82

FIG. 6.17 Interface step 2 exploring changing demand; portfolio level

In this pilot, the stakeholders were not informed how exactly each of the interventions would influence the preference scores of the stakeholders. The use of the model would give this insight to them.

After selecting the variables which to adjust, the stakeholders have to (1) press 'sync scenarios' to update the suitability of lecture halls based on the new student numbers (influences capacity of each activity) and walking distance (influences the accessibility of each lecture hall). Then, the stakeholders have to (2) press test allocation to make a new timetable and check if a feasible timetable can be made in this scenario. Finally, the stakeholders have to (3) press update future match to update the values of future match that are displayed in this user interface.

Step 3: Generating future alternatives

In step 3, the timetable interface can be used to check the effect of real estate interventions on the timetable. In the previous step, high-level adjustments have been made to the timetabling process. Aside from doing real estate interventions,

stakeholders can make some detailed adjustments to activities in the schedule in this step. In step 3, the stakeholders will most likely be using the tab 'match' to review the performance on specific criteria. (Figure 6.18). In this interface, the stakeholder can also click on the icon of each stakeholder to view their criteria in order to discover what has caused an increase in the overall preference score.

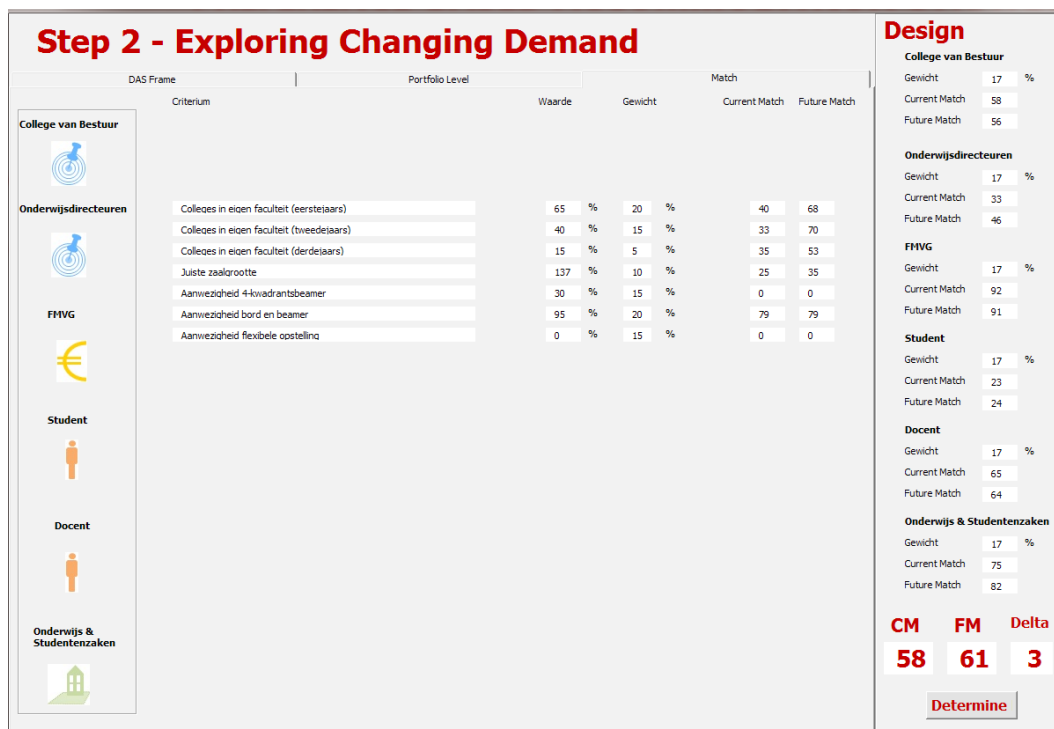

FIG. 6.18 Interface step 2 exploring changing demand; match

Based on the portfolio information, the stakeholder has an indication of where to start, but not specifically where to improve the match between supply and demand. By clicking on 'see objects' in the portfolio level tab (See Figure 6.13), the stakeholder navigates to a sheet that shows the status on each of these indicators for each lecture hall and for each activity. In this way, the stakeholder knows for which activity to review the stakeholder requirements, or for which lecture hall interventions need to be done. After making adjustments, the stakeholder can return to this screen and by pressing 'test allocation' the stakeholder can review what the improvement on these indicators is.

Interface object data

In interface object data, the stakeholders can see the effects of the allocation on each object (**Figure 6.19**). This interface is accessed via the 'see objects' button in the timetable interface. On the left side of the screen, the demand is listed: all the activities that are scheduled in the linear programming model. For each activity, the following information is shown for the current match and future design:

- Demand – the amount of hours scheduled per week;
- Not scheduled - the amount of hours that cannot be scheduled;
- Amount of suitable lecture halls – the amount of lecture halls in which this activity can be scheduled.

If there are hours that are not scheduled in the current match or future design, these are highlighted in red in **Figure 6.17** there is one activity for which this is the case in the current match and 3 in the future design. If there are activities that can only be scheduled in a few lecture halls, they are also highlighted in red; activities that can be scheduled in many lecture halls are marked in green. In **Figure 6.17** there are 18 activities that can only be scheduled in a few lecture halls. If the demands of these activities are adjusted, it will be possible to make a better timetable.

On the right side of the screen, the supply is listed: all the lecture halls in which the linear programming model can schedule activities. For each lecture hall, the following information is shown for the current match and the future design:

- Active – is the lecture hall active in the model and can activities be scheduled;
- Suitability – what percentage of activities can be scheduled in this lecture hall;
- Frequency rate – for which % of the total available time is the lecture hall scheduled.

If the suitability is higher than 45 percent – which means that 45 percent or more of all activities can be scheduled in this lecture hall – it is highlighted in green. If the occupancy rate of a lecture hall is higher than 50 percent, it is also highlighted in green. If interventions are done in a lecture hall with a low suitability percentage, it will increase the amount of activities that can be scheduled there and thus also make a better timetable possible.

Activities	Demand (hours)		Not scheduled (hours)		Amount suitable lecture halls (18 tot.)		Frequency rate (%)		Suitability (%) of the activities)		Lecture halls ON/OFF		Collegezaal			
	Current	Future	Current	Future	Current	Future	Future	Current	Future	Current	Future					
	Set	Reset														
BK BSc 1	22	22	0	0	0	0	0	0	0	0	0	FALSE	FALSE	Aula Auditorium	1	
BK BSc 3	19	19	0	0	0	0	92.5	100	42	42	TRUE	TRUE	FALSE	FALSE	Aula Zaal A	2
BK BSc 3 LINK	17	17	0	0	6	6	100	100	0	0	TRUE	TRUE	TRUE	TRUE	Aula Zaal B	3
BK BSc 4	16	16	0	0	9	9	47.5	100	0	0	TRUE	TRUE	TRUE	TRUE	Aula Zaal C	4
BK BSc 6	0	0	0	0	7	7	0	0	0	0	TRUE	TRUE	TRUE	TRUE	Aula Zaal D	5
BK MSc AR	15	15	0	0	0	0	92.5	100	0	0	TRUE	TRUE	TRUE	TRUE	BME Zaal A	6
CTG BSc CT1	14	14	0	0	0	0	0	0	42	42	TRUE	TRUE	TRUE	TRUE	BME Zaal B	7
CTG BSc CT1 LINK	0	0	0	0	6	6	0	0	0	0	FALSE	FALSE	FALSE	FALSE	BME Zaal C	8
CTG BSc CT2	10	10	0	0	0	0	0	0	0	0	FALSE	FALSE	FALSE	FALSE	BME Zaal D	9
CTG BSc TA1	8	8	0	0	0	0	0	0	30	30	TRUE	TRUE	TRUE	TRUE	BK Zaal A	10
CTG MSc SE HE	16	16	0	0	10	10	0	0	0	0	FALSE	FALSE	FALSE	FALSE	BK Zaal B	11
CTG MSc CME	7	7	0	0	0	0	0	0	0	0	TRUE	TRUE	TRUE	TRUE	CTG Zaal A	12
CTG Schakel	12	12	0	0	0	0	27.5	100	0	0	TRUE	TRUE	TRUE	TRUE	CTG Zaal B	13
JME BSc WB1	16	16	0	0	0	0	0	0	42	42	TRUE	TRUE	TRUE	TRUE	CTG Zaal C	14
JME BSc WB1 LINK	16	16	0	0	6	6	0	0	42	42	TRUE	TRUE	TRUE	TRUE	CTG Zaal D	15
JME BSc WB2	8	8	0	0	0	0	40	100	32	32	TRUE	TRUE	TRUE	TRUE	CTG Zaal E	16
JME BSc WB2 LINK	2	2	0	0	6	6	43	100	30	30	TRUE	TRUE	TRUE	TRUE	OTC Zaal A	17
JME BSc MT1	2	2	0	0	0	0	0	0	0	0	FALSE	FALSE	FALSE	FALSE	OTC Zaal B	18
JME BSc B1	6	6	0	0	0	0	93	100	38	38	TRUE	TRUE	TRUE	TRUE	EWI Zaal A	19
JME BSc B1 LINK	6	6	0	0	6	6	93	100	32	32	TRUE	TRUE	TRUE	TRUE	EWI Zaal B	20
JME BSc B2	8	8	0	0	0	0	0	0	0	0	FALSE	FALSE	FALSE	FALSE	EWI Zaal C	21
JME BSc B2 LINK	8	8	0	0	6	6	0	0	0	0	FALSE	FALSE	FALSE	FALSE	EWI Zaal F	22
JME BSc B3	3	3	0	0	10	10	0	0	40	40	TRUE	TRUE	TRUE	TRUE	IO Zaal vdB	23
EWI BSc ET1	6	6	0	0	0	0	100	100	20	20	TRUE	TRUE	TRUE	TRUE	LR Zaal A	24
EWI BSc ET2	4	4	0	0	0	0	0	0	0	0	FALSE	FALSE	FALSE	FALSE	LR Zaal B	25
EWI BSc T1	15	15	0	0	0	0	0	0	0	0	FALSE	FALSE	FALSE	FALSE	TBM Zaal A	26
EWI BSc T2	10	10	0	0	0	0	0	0	0	0	FALSE	FALSE	FALSE	FALSE	TNW Zaal A	27
EWI MSc EE	9	9	0	0	0	0	0	0	0	0	FALSE	FALSE	FALSE	FALSE	TNW Zaal B	28
TNW BSc TW-TN1	11	11	0	0	0	0	0	0	0	0	0	0	0	0	0	0
TNW BSc TW-TN2	16	16	0	0	0	0	0	0	0	0	0	0	0	0	0	0
IO BSc 1	8	8	0	0	7	7	0	0	0	0	0	0	0	0	0	0
IO BSc 2	10	10	0	0	0	0	0	0	0	0	0	0	0	0	0	0
IO BSc 2 LINK	5	5	0	0	8	8	0	0	0	0	0	0	0	0	0	0
IO BSc 3	5	5	0	0	7	7	0	0	0	0	0	0	0	0	0	0
IO MSc	21	21	0	0	0	0	0	0	0	0	0	0	0	0	0	0
LR BSc 1	17	17	0	0	0	0	0	0	0	0	0	0	0	0	0	0
LR BSc 1 LINK	12	12	0	0	0	0	0	0	0	0	0	0	0	0	0	0
LR BSc 2	17	17	0	0	0	0	0	0	0	0	0	0	0	0	0	0
LR BSc 2 LINK	0	0	0	0	0	0	0	0	0	0	0	0	0	0	0	0
LR Schakel	2	2	0	0	0	0	0	0	0	0	0	0	0	0	0	0
TBM BSc 1	17	17	0	0	0	0	0	0	0	0	0	0	0	0	0	0
TBM BSc 2	6	6	0	0	0	0	0	0	0	0	0	0	0	0	0	0
TBM Minor	15	15	0	0	0	0	0	0	0	0	0	0	0	0	0	0
TNW MSc SET	16	16	0	0	0	0	0	0	0	0	0	0	0	0	0	0
TNW MSc LST	4	4	0	0	0	0	0	0	0	0	0	0	0	0	0	0
Onderhoud	8	8	0	0	0	0	0	0	0	0	0	0	0	0	0	0
Overslag	24	24	0	0	0	0	0	0	0	0	0	0	0	0	0	0
Afstuderen	2	2	0	0	0	0	0	0	0	0	0	0	0	0	0	0
Slot 49	0	0	0	0	0	0	0	0	0	0	0	0	0	0	0	0
Slot 50	0	0	0	0	0	0	0	0	0	0	0	0	0	0	0	0

FIG. 6.19 Object Data

Interface with design information per stakeholder

Below the main interface two tables are shown with detailed information similar to the tables that were available in the first pilot study. This detailed information is directly linked to each of the specific stakeholders. In [Figure 6.20](#) design information per stakeholder for each of the criteria is shown separately and in [Figure 6.21](#) design information per stakeholder about each of their constraints is given.

The design information per stakeholder and criterion gives the stakeholders guidance (which intervention to select) and shows them the changes in preference score as a result of a (set of) interventions. All stakeholders have their own section. During the workshops the systems engineers observed that the stakeholders did not use all of the information that was provided in the table. As in the first pilot, the column 'delta' was most used as guidance for opportunities to raise the overall preference score.







Decision maker	Decision variable	Weighted score	Maximum score	Delta	Value	Unit	Score	Weight	
Executive Board 	1 Education in classrooms and project rooms (%)	26	30	4	43 %		87	30%	
	2 Student satisfaction (%)	0	30	30	23 %		0	30%	
	3 Teacher satisfaction (%)	11	20	9	65 %		57	20%	
	4 Occupancy rate (%)	20	20	0	73 %		100	20%	
		58	100	43					
Education directors 	5 First year students: lectures in own faculty	8	20	12	47 %		40	20%	
	6 Second year students: lectures in own faculty (%)	5	15	10	28 %		33	15%	
	7 Third year students: lectures in own faculty	2	5	3	13 %		35	5%	
	8 Ratio between students and lecture hall capacity	3	10	8	144 capacity / group size		25	10%	
	9 Availability of four-quadrant beamer (%)	0	15	15	29 %		0	15%	
	10 Availability of blackboard and beamer (%)	16	20	4	94 %		79	20%	
	11 Availability of flexible chairs (%)	0	15	15	0 %		0	15%	
	12 Education in small classrooms (%)	-	-	-	-		-	-	
			33	100	67				
	Student Council 	13 Amount of lectures recorded (Collegerama) (%)	0	15	15	96 %		93	15%
		14 Amount of lectures in the evening	20	20	0	0 %		100	20%
		15 Amount of movements between buildings	10	15	5	0,3 times		71	15%
16 Lectures in own faculty (%)		0	30	30	42 %		0	30%	
17 First year students: lectures in own faculty (%)		-	-	-	-		-	-	
18 Second year students: lectures in own faculty (%)		-	-	-	-		-	-	
19 Third year students: lectures in own faculty (%)		-	-	-	-		-	-	
20 Availability smartboard/four-quadrant beamer (%)		1	10	9	71 %		56	10%	
21 Flexible lecture halls (%)		0	10	10	18 %		69	10%	
			31	100	69				
Teacher 		22 Standard equipment (%)	18	20	2	100 %		100	20%
	23 Blackboards/whiteboards (%)	13	20	7	100 %		100	20%	
	24 Flexible chairs (%)	0	20	20	18 %		0	20%	
	25 Walking distance for students (minutes)	20	20	0	5 %		95	20%	
	26 Amount of lectures recorded (Collegerama) (%)	14	20	6	96 %		98	20%	
	27 On-site assistance (minutes)								
	28 Assistance in transport of teaching materials (hours)								
	29 Reservation of parking spots (%)								
			65	100	35				
	E&S Affairs 	30 Walking distance for students (minutes)	35	35	0	5 minutes		98	35%
31 Ratio between students and lecture hall capacity		11	30	19	144 capacity / group size		100	30%	
32 Occupancy rate (%)		13	35	22	63 %		25	35%	
33 Functionality of lecture hall equipment (%)									
		59	100	41					
FMRE 	34 Occupancy rate (%)	30	30	0	73 %		87	30%	
	35 Ratio between students and lecture hall capacity	22	30	8	71 group size / capacity		67	30%	
	36 Investment costs (€)	0	40	40	596480 €		0	40%	
		52	100	48					

FIG. 6.20 Design information per stakeholder per criterion

In **Figure 6.21** the design information per stakeholder per constraint is given. If a certain constraint was not met this is indicated in this figure (constraint turns red).

Decision maker	Design Constraint
Student Council	1 Two-way interaction with the teacher at all times 2 The amount of students present cannot exceed the lecture hall capacity
E&S Affairs	3 The DUT must have enough capacity to accommodate all mandatory activities 4 The maximum amount of scheduled hours per student per day is eight hours 5 Mandatory courses cannot be scheduled at the same time

FIG. 6.21 Design information per stakeholder per constraint

This figure was rarely used during the workshop by the stakeholders. The facilitator or system engineer were the one that checked this figure but only when an alternative was designed that was very promising.

Input interface

In the model, each of the stakeholders had their input interface where all the information from step 1 to 4 was displayed (see Figure 6.22). The visualization of each preference curve was enriched during the workshops by adding two points on the curves similar to the first pilot. In the workshops the stakeholders did not go back to their input screen to look at the position of the current and future situation.

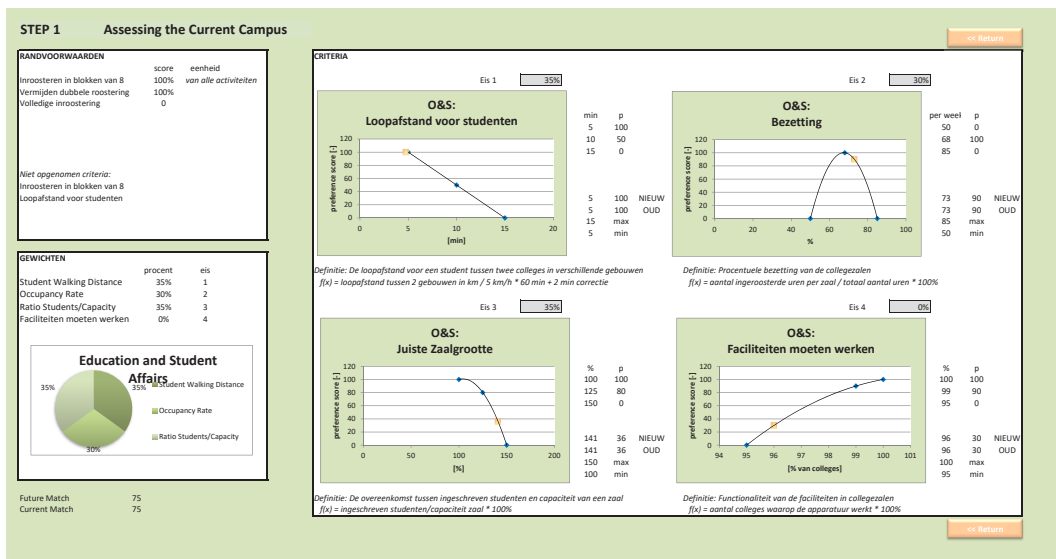

FIG. 6.22 Interface assessing the current campus; overview of requirements (step 1 to 4)

PAS interfaces and DAS frame

In the second pilot study the relationship between PAS and DAS has been made more explicit and clear. In the main interface (**Figure 6.13**) the three of the four tasks that can be done in PAS are displayed. In this model the tasks are referred to as steps. Later on the interfaces are explained based on these three steps. Many interfaces show both the first and second step. An overview of the links between PAS and DAS is shown in **Table 6.2**.

TABLE 6.2 Overview links PAS and DAS

Step/Task	Figures
1 assessing the current campus	6.13, 6.15, 6.20 and 6.22
2 exploring changing demand	6.16, 6.17 and 6.18
3 generating future models	6.13, 6.14, 6.18, 6.19, 6.20 and 6.22

Additional tools

In this pilot study no additional tools have been used.

6.2.2 Workshops to design alternatives (step 5)

The two workshops had different objectives, but in each pilot the workshops were approached slightly different. The first workshop for this pilot was an individual workshop. The objective in this workshop was to design an alternative with the highest overall preference for a particular stakeholder. (Impression in **Figure 6.23**)

The second pilot was a group workshop and consisted of three assignments. For the first assignment the stakeholders were split into group a and group b. Group a was assigned to design an alternative with the highest overall preference using the interventions in the lecture halls. Groups b on the other hand, could make use of the interventions in the scheduling process. In the second assignment the groups were joined into one group and asked to design an alternative with the highest overall preference, using all interventions. The third assignment was to design an alternative with the highest overall preference for different futures.



FIG. 6.23 Impression second workshop first assignment Note from Valks, 2013, p. 65

Group 1 designed an alternative by doing interventions in the timetable. A minor increase in the overall preference score could be reached by these interventions, most notably on the criteria of the directors of education. Group 2 designed an alternative by doing interventions in the lecture halls. By adding a number of amenities they managed to reach an overall preference score of 65. Especially the teachers and students' preference increased in this alternative, whilst the preference of FMRE decreased due to high intervention costs. These alternatives were put together and with some minor adjustments the final design alternative was made, with an overall preference score of 69. (Valks, 2013, p. 69) (see **Table 6.3**).

TABLE 6.3 Best alternatives as designed in the second workshop

Alternative	Overall preference score	Type of interventions	Solution space for the schedule
Current portfolio lecture halls	58	None	6.830
Alternative 1 Group 1	62	Lecture hall interventions	6.897
Alternative 2 Group 2	68	Timetabling & lecture hall interventions	11.295
Alternative 3 Entire group	69	Timetabling and lecture hall interventions	12.639

6.2.3 Iterating between alternatives (step 5) and requirements (steps 1 to 4)⁵⁷

At the outset of the project, our expectation was that this process of design would help the participants to better understand the relationship between the design alternatives and their requirements. This was confirmed in the evaluation: the participants indicated that whilst the method of determining preferences is easy, accurately determining which preference is related to a certain value is not. Assigning preference scores to values of e.g. the occupancy rate can be arbitrary at first.

By repeating the cycle of determining preferences and making designs a number of times, the participant can see what the effect of the decisions made in the design is, and how those decisions affect the stated preference. In this paragraph, the iteration of the stakeholders between their requirements (i.e. step 1 to 4, also called demand) and the alternative design (i.e. step 5 also called future supply) is shown for the student council.

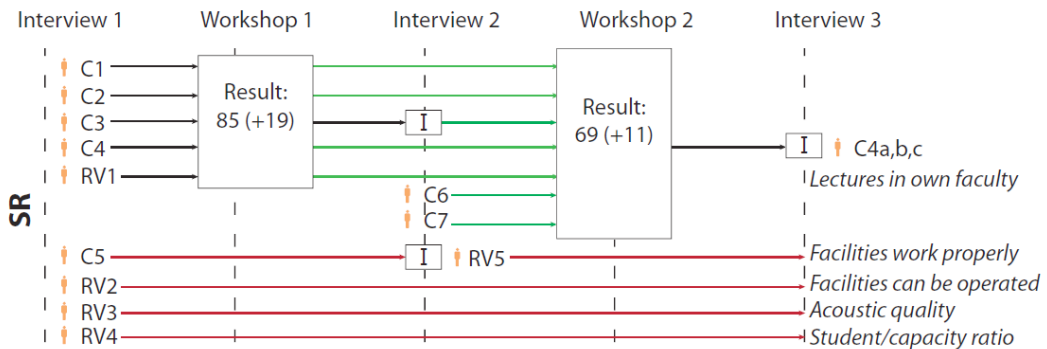

FIG. 6.24 Iteration between requirements and alternatives Note from Arkesteijn et al., 2015, p. 117 SR stands for student council, C stands for criterion, RV for boundary condition

In **Figure 6.24** the development of the criteria (C) and boundary conditions (RV) given by the Student Council (SR) are displayed. After workshop 1, the Student Council participant modified one criterion (C3) and added two new ones

⁵⁷ Paragraph 6.2.3 was published as section 6.2.1 in Arkesteijn et al., (2014, pp. 116–117). The cited text is displayed in purple, added text in black. Figure numbers have been altered to suit the thesis.

(C5 and C6). After workshop 2, he modified one criterion (C4) and split it into three separate criteria. In both of these examples the weights between the criteria were also adjusted.

6.3 Pilot study 3: Oracle's office locations

6.3.1 Interfaces to design alternatives (step 5)

The main objective of the stakeholders in the workshop in step 5 'designing alternatives' is to maximize the overall preference score. In this pilot the stakeholders not only designed alternatives themselves. Next, to their own design, an optimization tool was also used to generate alternatives. In this paragraph the design interfaces that have been used by the stakeholders in this pilot will be shown. Note that De Visser (2016) refers to the design interface as GUI which is the abbreviation of Graphical User Interface. In the first main design interface the stakeholders can design alternatives. The second interface shows detailed information per criterion and enables the stakeholders to refer back to their input. In this particular pilot one extra design tool has been created.

This paragraph is based on De Visser (2016, pp. 67, 71-72)⁵⁸.

Main design interface⁵⁹

The final GUI is shown in **Figure 6.25** and provides the possibility to design portfolio alternatives quite intuitively by filling out a set of checkboxes. This is done in the design table on the left side, which also provides the location preference score. The selected locations appear in the table in the middle, presenting the current design.

⁵⁸ The cited or summarized text is displayed in purple, added text in black. Paragraph and figure numbers adjusted to this thesis.

⁵⁹ The numbers in the main design interface are presented with two decimals, which suggests a certain level of precision. The systems engineer and model expert realize that this could give the wrong signal. The stakeholders have been informed about this.

Above this table, the number of locations selected is shown. Once selecting the button 'Calc. Preference', the overall preference score for the design appears in the top right corner. In the table on the right side with the criteria and criteria weights, the average physical values and preference scores per criterion appear for the portfolio design. Below this table, the difference between the preference score for the current portfolio and the alternative design appears.

Moreover, De Visser built some additional features that have been implemented to improve the design process. The possibility to name and save design alternatives makes it possible to get back to previous ideas and build upon them by recalling them in the design screen. Other features are the possibility for the stakeholders to disable the design constraint on the number of locations and to unselect all locations at once. Finally, the visual feedback that is provided by De Visser, in the middle of the design interface, shows whether or not the designed alternative is within the design boundaries (De Visser, 2016, pp. 71-72).

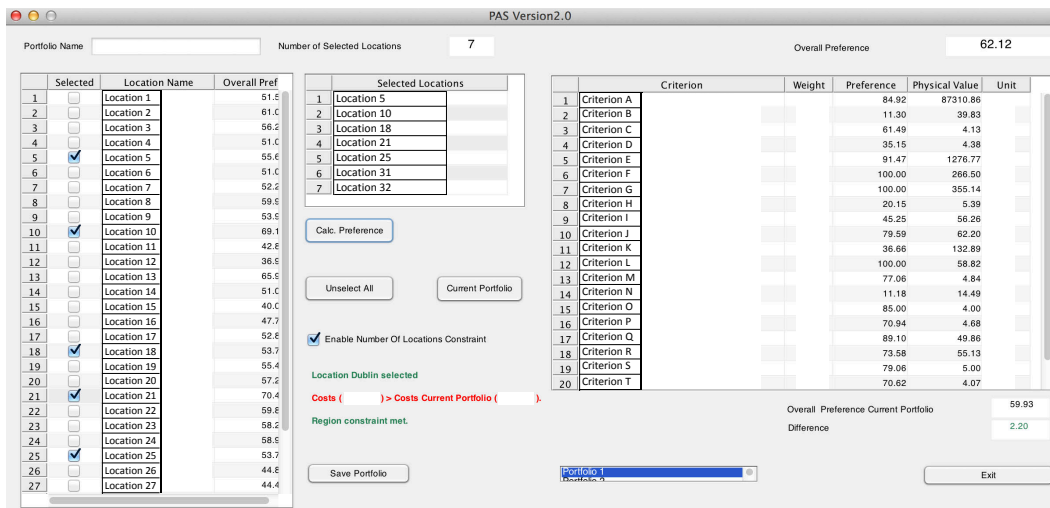

FIG. 6.25 Main design interface Note from De Visser, 2016, p. 71

Input interface

The input interface provides direct feedback to the interviewee with to their input. This interface is similar to the design interfaces in the first and second pilot. This interface has been used during the interviews. As the interviews were held via a conference call connection, the systems engineer shared his screen with the

interviewee. As this interface was made in MS Excel and not in Matlab⁶⁰, it was not possible to give feedback about the portfolio alternatives on the input curves as was done in the first two pilots. This means that this interface was used during the interviews and not during the workshops (De Visser, 2016) (see Figure 6.26).

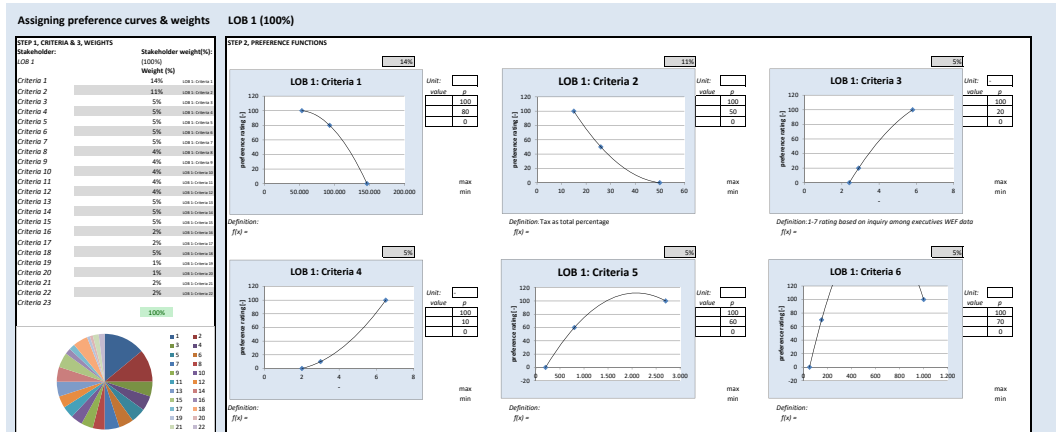

FIG. 6.26 Input interface with overview per stakeholder of step 1 to 3 Note from De Visser, 2016, p. 67

PAS interfaces and DAS

In the third pilot there was no direct link between PAS and DAS.

Additional design tools

One additional design tool was used in the process. Because the physical values and criterion scores for the individual locations were not visible in the main design interface these values were provided separately. These values remained the same during the whole pilot study. The stakeholders used this file during workshops. The system engineer indicated that it is possible that the stakeholders not fully understood this tool, because they did not select the location with the highest overall preference score into their new portfolio. This means that this overview should have been explained more to the stakeholders.

60 Matlab (matrix laboratory) is a multi-paradigm numerical computing environment and proprietary programming language developed by MathWorks. <https://en.wikipedia.org/wiki/MATLAB>

6.3.2 Workshops to design alternatives (step 5)⁶¹

Each workshop started with an introductory presentation by the systems engineer, who was responsible for the model and workshop structure, to refresh the goal of the research project and the workshops and to present the expected outcomes of the workshop. In this presentation also the two elements in the workshops were introduced; designing an optimum location portfolio for LOB 1 [Line of Business] and comparing the rankings from the original study and PAS. The introduction to the first workshop also included an elaborate explanation of the model backside in a visual representation. Each presentation ended with an explanation of the assumptions made in the modeling of the stakeholders' input and an explanation of the design interface. Also the systems engineer indicated that from that point on, the control over the model was in the hands of the users⁶².

In the workshops, the users received two design assignments; one with the current portfolio plus one location and one to design a portfolio regardless of the current portfolio. During the first workshop, one of the users correctly observed from the design interface how the overall preference score for a portfolio alternative followed from the preference scores based on the average physical values per criterion. Also it was observed that in order to design the optimum portfolio it would be logical to start with the locations with the highest individual preference score, although these scores were not directly used to arrive at the overall preference score. Another element that stood out in this design process was that one of the users came up with the note that in reality some locations would never be left by the LOB because they needed to cover certain regions. therefore, she thought that these locations should always be included, which resulted at the end of the workshop in an additional constraint, requiring a certain regional coverage. Also the observation was made that designing the portfolio with the highest preference scores, meant that a lot of expensive locations were included. In real life this could not be the case because it would make the portfolio too costly. The users discussed amongst one another that costly locations are not forbidden, but should be compensated with cheaper locations. This resulted in a constraint that determines that the average costs for a portfolio alternative are not allowed to exceed the costs of the current portfolio. The formulated two constraints resulted in three new design constraints because one of them actually incorporated two separate constraints.

⁶¹ The cited or summarized text is displayed in purple, added text in black. Paragraph and figure numbers adjusted to this thesis.

⁶² The term user here refers to 'user' of the model, i.e. workshop participant or involved stakeholder.

In the comparison of rankings in the first workshop, the users were interested to see what the individual effects of using preference curves and new weights are on the ranking. They recognized that the new weights might represent progressive insight in the matter from the LOB's point of view.

In the second workshop, designing portfolio alternatives that did not violate either of the constraints had become somewhat more complex as the users indicated. However, they also noted that it made them more aware of the implications of certain decisions, e.g. regions with only one location. Also the users observed that in the future they might need somewhat more refinement in the location data by means of including the headcount per location in order to optimize the portfolio for costs versus regional 74 coverage, i.e. covering a region with an expensive location, however with low headcount to decrease total costs (De Visser, 2016, pp. 73-74).

6.3.3 Iterating between alternatives (step 5) and requirements (steps 1 to 4)

De Visser (2016, p. 93) also looked at the iterations during the process and displayed them in **Figure 6.27** and reported the following:

The **[Figure 6.27]** ... shows the development of the criteria and design constraints over the course of the pilot study. It shows that in the first interview the stakeholders established a set of criteria and one constraint that led to the resulting preference score in workshop 1. After workshop 1, the users included three extra constraints. This shows that the users gained insight in their input through the design process in the first workshop and were able to adapt it accordingly. This resulted in a better representation of their preferences in the model. However, from the **[Figure 6.27]** it also becomes clear that no iterations were made in the criteria. This can be explained by the fact that this pilot study is conducted with an existing case for which the criteria were already deemed suitable. Finally, the **[Figure 6.27]** shows that the brute force function was indeed able to find a portfolio alternative with a higher preference score than the stakeholders could find in the second workshop.

The evaluation of the ... PAS⁶³ ... shows that the participative process of design really pays-off in terms of model acceptance and trust in the model and its outcome. One

⁶³ De Visser in his thesis referred to PAS as improved PAS. This is PAS including the use of an optimization tool. For ease of reading in the text of De Visser, it is referred to as PAS in this thesis

of the stakeholders even indicated already before the search algorithm outcomes were available that she would trust them, because she understands how the model works. Eventually, the outcome of the brute force function was indeed accepted by the stakeholders as final result of the pilot study.

In this pilot, as can be seen in the [Figure 6.27], the stakeholders did not alter any criteria. It is logical that they did not need the iterations like they did in the first two pilots, because this pilot was a repetition of their own location decision process in which the criteria were already set.

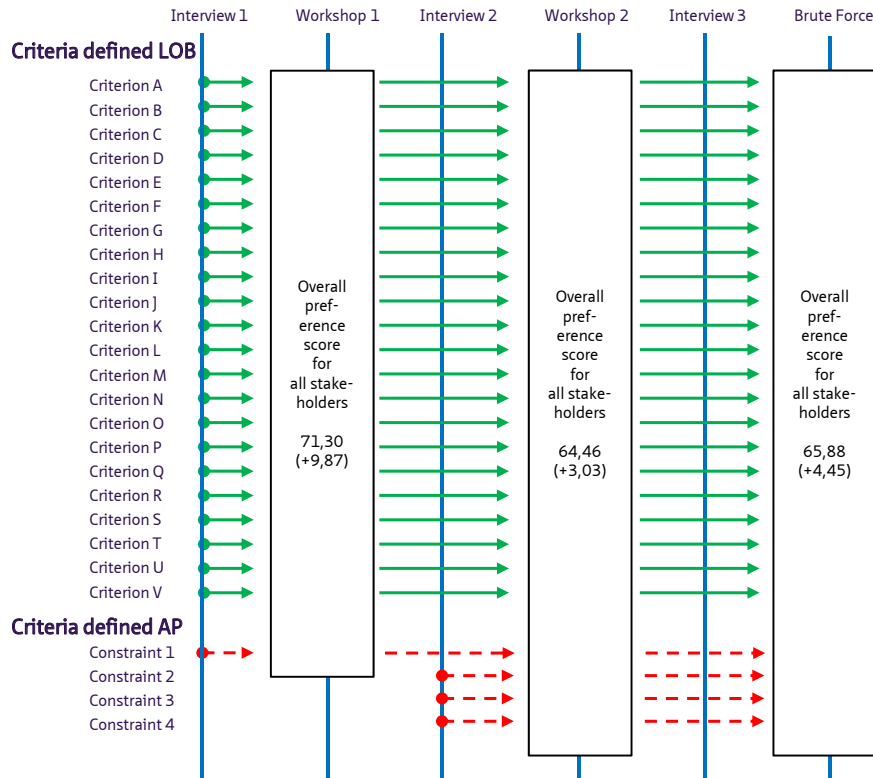

FIG. 6.27 Iteration between requirements and alternatives Note from De Visser, 2016, p. 93

In this pilot has implemented a few improvements, based on the observations and interviews from the first two pilots. These improvements “. . . concern the way in which the users are made familiar with the backside of the system, the evaluation

of the perceived ease of use and justification of the model outcomes by providing the preference score per criterion. In the evaluation, the users were predominantly positive about these aspects, although for some the explanation of the model back-end could have been more in-depth (De Visser, 2016, p. 93).

6.4 Pilot study comparison and conclusion

The stakeholders in all three pilots have successfully performed the two activities: workshops and interviews. In these activities, all six steps have been performed. By iterating between the steps in the interviews and workshops a number of times, the stakeholders better understood their input and were able to improve it. This means that the representation of their preferences in the model better depicts the actual situation. The use of such a learning process in the context of work practice and problem-solving is described by Schön (1987) as reflection in action.

In all pilots it has been shown that workshops with all stakeholders produced satisfactory results. The stakeholders were presented with several assignments which helped them design an alternative CRE portfolio with the higher overall preference. Most stakeholders preferred to have two joint workshops instead of one. PAS gives stakeholders the opportunity to determine the amount of workshops and interviews, stopping the iterative process only when all stakeholders accept the result. In the further development of PAS, it is worthwhile to experiment with a (partially) stakeholder operated model.

The amount of the available design interfaces per pilot differed ([Figure 6.28](#)) as well as the intensity in which the design interfaces were used. In all pilots, the main interface in which alternatives could be designed, was used most. Furthermore, the interface displaying the interventions (if available) was used often. In the second pilot, the preference scores per stakeholder were integrated in the main interface. The interface with the design information per stakeholder and per design variable was used less, and in the first two pilots, was used mainly by the facilitator and system engineer. In the third pilot, this information was integrated in the main interface. In general, the conclusion is that the design interfaces with more condensed display of information were most used.









interfaces	Pilot 1 food facilities (TUD)	Pilot 2 lecture halls (TUD)	Pilot 3 office locations (Oracle)
Main design interface	 <p>most used interface & visualization contains information</p>	 <p>most used interface & visualization only shows presence location</p>	 <p>most used integrated interface, lacks portfolio visualization</p>
Intervention interface	<p>used interface</p> 	<p>used interface</p> 	<p>Not present</p>
Interface with design information per stakeholder	<p>Too detailed / less used</p> 	<p>Too detailed / less used</p> 	<p>Not present</p>
Basics of PAS	<p>Not present</p>		<p>Not present</p>
Interface with Object data	<p>Not present</p>		<p>Not present</p>
Input interface	<p>Used during interviews not in workshops</p> 	<p>Used during interviews not in workshops</p> 	<p>Used during interviews not in workshops</p> 

FIG. 6.28 Overview of interfaces

The design interfaces for the pilots differed (see [Figure 6.28](#)). The first and second pilot were visually more similar for two reasons. First of all, they were part of the same pilot study at the TU Delft and performed and led by the author. Secondly, pilot one and two were created in MS Excel, whereas pilot three was created in Matlab. The models for the first and second pilot, were more visual, while in the first pilot the visualization (size and type of the food facilities) contained most information. The model for the third pilot was less visual but contained more information in the main design interface. In the further development of PAS, it is worthwhile to enhance and experiment with the main design interface in the mathematical model.

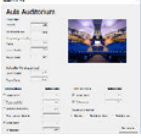
The relationship between PAS interfaces and DAS differed per pilot. Whereas, the second pilot study made the most explicit relation between the two, the first pilot did this only briefly. Since some stakeholders at TU Delft were familiar with DAS, it made sense to make an explicit link. In the third pilot the interfaces did not refer to DAS.

The type of information displayed in the main design interfaces differed as well (see [Figure 6.29](#)). Per pilot, it is displayed which information is given in the main interface, and which information is given in other interfaces. The main interface in each pilot displayed the alternative CRE portfolio, the overall preference score of both the current situation as well as the newly designed alternative. It also showed the added value of the alternative in comparison to the current situation.

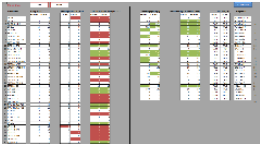
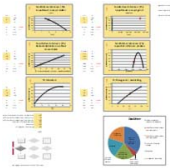
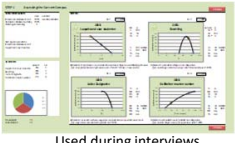
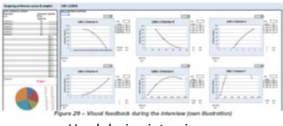
The second pilot integrated more information in the main design interface. Each of the stakeholders could also see the preference score for their design variables for the current situation, the new alternative and the added value. The stakeholders could also select interventions in this interface for all of the lecture halls at the same time. The third pilot contained most information in the main design interface but did not visualize the portfolio alternative. In this interface, interventions could be made, the designed portfolio was displayed and they received feedback on the constraints. Additional information for each design alternative in this interface was: the location preference score, the decision variable, decision variable weights, the average decision variable values, and preference scores per decision variable. In this pilot, it was also possible to name and save a design alternative, to disable the design constraint on the number of locations, and to unselect all locations at once.

steps	pilot 1	pilot 2	pilot 3
step 1 decision variables			
step 2 curves	other	other	other
step 3 weights			
step 4 constraints	main		
step 5 alternatives		main	
interventions	other	other	
physical values			
step 6 results			
OPS alternative	main	main	main
OPS current situaton			
added value (OPS alternative - OPS current situation)			
OPS per stakeholder	other	other	
OPS per criterion			
OPS per location	not given	not given	

FIG. 6.29 Comparison of the information provided in the user interfaces

The additional design tools in all pilots have not been used much. It is recommended to research whether a reference model, as used in the first pilot, or other tools can be of more use if they are offered to the stakeholders differently or earlier in the process to the stakeholders when defining their design variables.

7 PAS mathematical models to achieve alignment

chapter 2	CRE alignment state of the art and scientific gap
-----------	---

Preference-based Accommodation Strategy (PAS)
design and decision approach

Developing PAS		Testing PAS			Evaluating PAS
chapter 3	chapter 4	chapter 5	chapter 6	chapter 7	chapter 8
fifteen basic concepts and definitions from decision, design and management theory	2nd procedural rationality	steps			steps
	3rd structural rationality		stakeholders & activities		stakeholders & activities
	1st substantive rationality			model	model

chapter 9	Reflecting upon PAS
-----------	---------------------

chapter 10	Conclusions and recommendations
------------	---------------------------------

7 PAS mathematical models to achieve alignment

The focus in this chapter is on the component mathematical models of PAS (see [Figure 7.1](#) and [Figure 7.2](#)). PAS can only be performed if the system engineers are able to build a mathematical model of the problem situation for each of the pilot studies. In this chapter, I will show that the system engineers were able to do this for all three pilots.

Typically, a subset of the alternative is infeasible. When the feasible set of alternatives can be characterized mathematically, the PFM algorithm can search an optimal alternative within this set (either by an exhaustive search or by sampling, depending on the size of the feasible set). Otherwise, if a characterization of the feasible set is not available to the algorithm, the group decision makers – the stakeholders – can propose possible feasible alternatives for consideration. The algorithm can then rate these alternatives.

This chapter has the following structure:

- TU Delft pilot for the food facilities in paragraph 7.1;
- TU Delft pilot for lecture halls in paragraph 7.2;
- Oracle’s pilot for office locations in paragraph 7.3;
- Pilot comparison and conclusion in paragraph 7.4.

The mathematical models are explained for each of the pilots as follows: the model structure (first subparagraph), the model formulas (second subparagraph) and the optimization tool (third subparagraph).

Recall, that in step 5 alternatives are generated in two separate ways:

- A The group of decision makers self-designs alternatives, use the design constraints to test the feasibility of the design alternatives, and use the PFM algorithm to yield an overall preference score of these feasible design alternatives;
- B The system engineer generates feasible design alternatives and uses the PFM algorithm to find the feasible design alternative with the highest overall preference score.

The decision makers are able to design alternatives (step 5a) with the model that is explained in the first and second subparagraphs. The system engineer is able to generate alternatives (step 5b) with the optimization tool is, as is explained in the third subparagraph.

The mathematical models for the pilot studies have been built by the system engineer and the facilitator. The author had the role of the facilitator. The system engineer for the first pilot was Binnekamp, for the second pilot it was Valks with the aid of Barendse, and for the third pilot the system engineers were De Visser with the guidance of De Graaf. Valks and De Visser cooperated in this study as graduate students with the author as their main mentor and Binnekamp, Barendse and De Graaf as their second and/or third mentors.

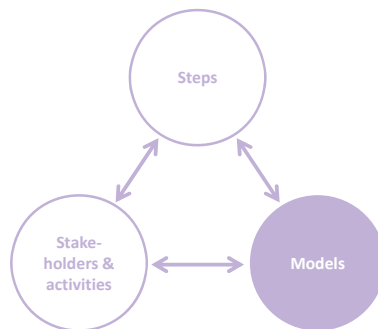

FIG. 7.1 Focus on PAS component mathematical model
Note adapted from Arkesteijn et al. 2017, p. 245

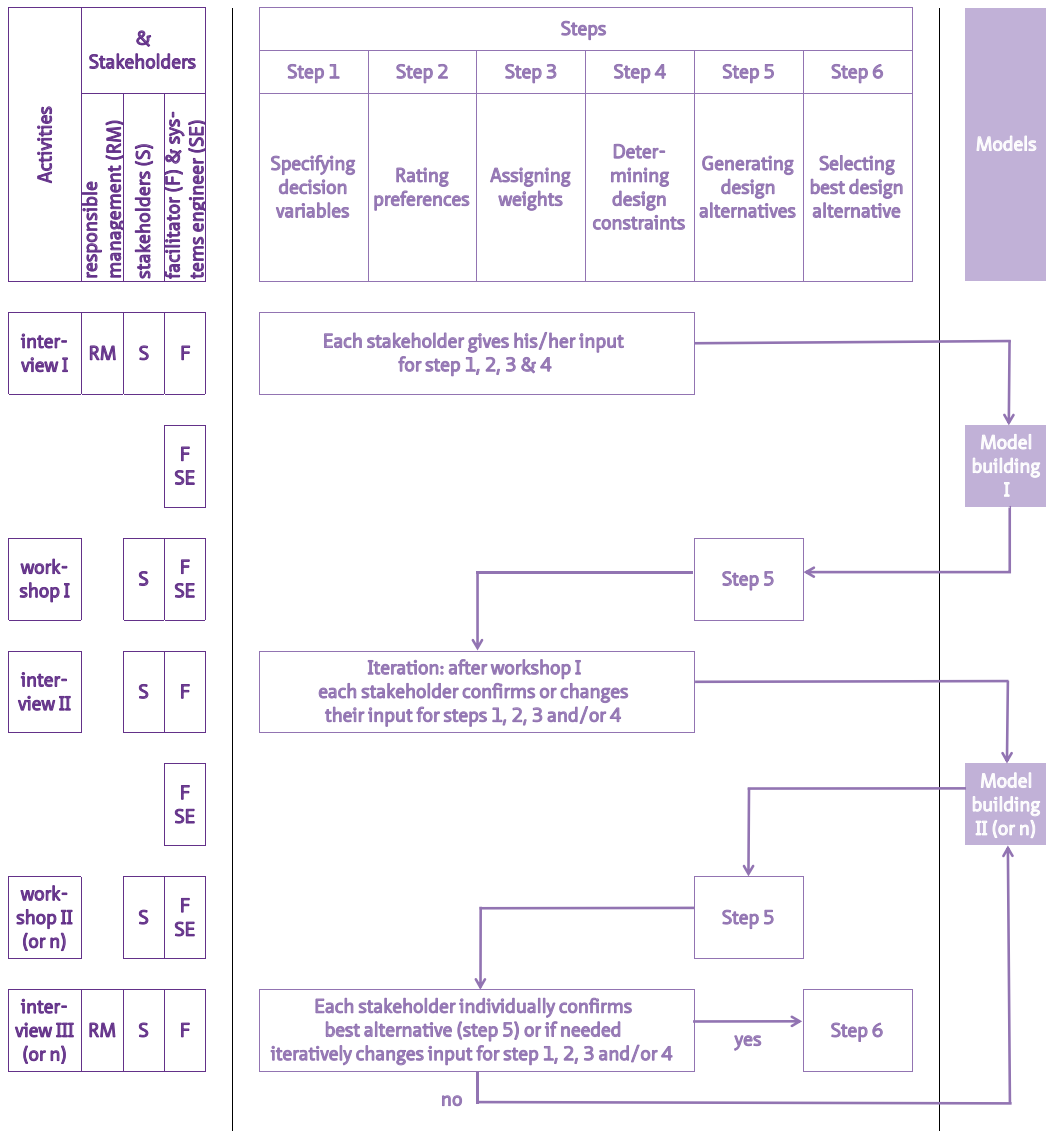

FIG. 7.2 PAS flowchart with emphasis on mathematical models Note adapted from Arkesteijn et al. 2017, p. 248

7.1 Pilot study 1: TU Delft's food facilities

7.1.1 Model's structure

The structure of the mathematical model for the food facilities is similar to the generic structure of the mathematical model. In principal this generic mathematical model suffices when no special circumstances are present.

7.1.2 Model's Formulas

In this paragraph, the functions that computed the preference score of the decision variables are described. Firstly, an alternative as input is described, secondly the functions that calculate the *decision variable value* per decision variable and thirdly, the specific functions in this pilot that convert the decision variable into a preference score per decision variable.

An alternative as input

An *alternative* is described as follows:

The *state vector* is an alternative in the form (x_1, \dots, x_{16}) where x_j is the state of food facility j .

At any given time, a dynamic system has a *state* given by a tuple of real numbers (a vector) that can be represented by a point in an appropriate state space.

The state of a food facility (x) could be:

- 1 No food facility;
- 2 Coffee corner;
- 3 Restaurant for lunch without coffee corner;
- 4 Restaurant for lunch and dinner with coffee corner;
- 5 Restaurant for lunch with coffee corner;
- 6 *Faculty club*;
- 7 Restaurant concept *middle*;

- 8 Restaurant concept *large*;
- 9 Coffee corner with workplaces;
- 10 Restaurant for lunch without coffee corner with workplaces;
- 11 Restaurant for lunch and dinner with coffee corner with workplaces;
- 12 Restaurant for lunch with coffee corner with workplaces.

Note, that even though twelve states were available, not each state was feasible for each food facility (see [Figure 7.3](#)).

states	food facility															
	1	2	3	4	5	6	7	8	9	10	11	12	13	14	15	16
1	green	green	green	green	green	green	green	green	green	green	green	green	green	green	green	green
2	grey	grey	green	grey	grey	grey	green	grey	green	grey	grey	grey	grey	grey	grey	grey
3	green	grey	grey	green	grey	grey	grey	green	grey	grey	grey	grey	grey	grey	grey	grey
4	grey	green	grey	grey	grey	green	grey	grey	grey	grey	grey	grey	grey	grey	grey	green
5	grey	grey	grey	grey	green	grey	grey	grey	grey	green	green	green	green	green	green	green
6	green	green	grey	grey	green	green	grey	green	green	green	green	green	green	green	green	green
7	green	green	grey	grey	green	green	grey	green	green	green	green	green	green	green	green	green
8	green	green	grey	grey	green	green	grey	green	green	green	green	green	green	green	green	green
9	grey	grey	green	grey	grey	grey	green	green	grey	grey	grey	grey	grey	grey	grey	grey
10	green	grey	grey	green	grey	grey	grey	green	grey	grey	grey	grey	grey	grey	grey	grey
11	grey	green	grey	grey	grey	green	grey	grey	grey	grey	grey	grey	grey	grey	grey	grey
12	grey	grey	grey	grey	green	grey	grey	grey	grey	green	green	green	green	green	green	green

FIG. 7.3 Feasible states per food facility (grey = infeasible and green = feasible)

To understand why not all states were feasible it is important to understand the difference between a state and an *intervention*. An intervention is a transformation that brings a system from one state into another. The interventions, as presented in paragraph 5.1, in this pilot were:

- 1 Refrain from action;
- 2 Remove the food facility;
- 3 Convert the existing food facility to new concept *middle*, *large* or *faculty club*;
- 4 Create a new concept *middle*, *large* or *faculty club*;
- 5 Upgrade the existing food facility.

Going back to the states, states 2 to 5 are related to the *current situation*, whereas states 1 and 6 to 12 are related to the *future situation*. In general, each current food facility can be transformed into state 6 to 8. Current food facility state 2 (coffee corner) can be transformed into state 9 (coffee corner with workplaces) with

intervention 5 (upgrade the existing food facility). The same holds for current food facilities with states 3, 4 and 5; they can be transformed respectively into state 10, 11 and 12 as can be seen in [Figure 7.3](#). This means states 9 to 12 are the outcome of intervention 3 in a current food facility. Food facilities 15 (Sports Centre) and 16 (Inholland) cannot be transformed because they are not in ownership of TU Delft (see also [Table 5.1](#)).

In the mathematical model, as shown in chapter 6, the stakeholders were presented with feasible interventions instead of the abovementioned states.

Functions to calculate the decision variable value per decision variable

The model has the following twenty-nine functions.

In all functions the *state vector* is an alternative in the form (x_1, \dots, x_{16}) where x_j is the state of food facility j .

If the *state vector* is known, the following eleven functions VAR_1 to VAR_11 obtained the decision variable value per decision variable from the dataset. The variables are not similar to the unique variables as explained in [Table 5.4](#).

Var_1

Syntax `Var_1(StateVector)`

Return value This function returns the value of the decision variable for decision variable 1 being the minimal walking time (in minutes) from a faculty to a food facility of concept 1 as it applies to users of all faculties. Concept 1 refers to the food facilities with state 3, 5, 7, 10 and 12.

Var_2

Syntax `Var_2(StateVector)`

Return value This function returns the value of the decision variable for decision variable 2 being the minimal walking time (in minutes) from a faculty to a food facility of concept 2 as it applies to users of all faculties. Concept refers to the food facilities with state 4, 8 and 11.

Var_3

Syntax `Var_3(StateVector)`

Return value This function returns the value of the decision variable for decision variable 3 being the percentage of seats in all food facilities that can be used for working.

Var_4

Syntax `Var_4(StateVector)`

Return value This function returns the value of the decision variable for decision variable 4 being the percentage of seats having a good acoustics over all food facilities.

Var_5

Syntax `Var_5(StateVector)`

Return value This function returns the value of the decision variable for decision variable 5 being the average ambience of all food facilities.

Var_6

Syntax `Var_6(StateVector)`

Return value This function the value of the decision variable for decision variable 6 being the average number of floors of where the food facilities are located.

Var_7

Syntax `Var_7(StateVector)`

Return value This function returns the value of the decision variable for decision variable 7 being the average accessibility of all food facilities, being the average number of doors in a faculty between its entrance and its food facility [doors].

Var_8

Syntax `Var_8(StateVector)`

Return value This function returns the value of the decision variable for decision variable 8 being the average walking time (in minutes) from the entrance of a building to a food facility.

Var_9

Syntax `Var_9(StateVector)`

Return value This function returns the value of the decision variable for decision variable 9 being the average percentage of food facilities labeled diverse.

Var_10

Syntax `Var_10(StateVector)`

Return value This function returns the value of the decision variable for decision variable 10 being the average coziness of food facilities.

Var_11

Syntax `Var_11(StateVector)`

Return value This function returns the value of the decision variable for decision variable 11 being the average findability of the food facilities.

Functions to convert the decision variable value into a preference score per decision variable

Now that the decision variable values per decision variable are known, they can be converted into a preference score using the principal formula as described in paragraph 4.5.1. In the workspace, one of the variables is a column vector containing the weights of each decision variable given by the stakeholders corrected for stakeholder weight see paragraph 5.1. This variable is called `CritWeights`, see last column in [Table 7.1](#). The first two columns show the related decision variable and functions. The index refers to the unique preference score and is not related to earlier indices.

TABLE 7.1 Workspace pilot 1

Decision Variable	Function	Index	Weight
Minimal walking distance to concept 1	Pref_1_FS	1	0.0875
Minimal walking distance to concept 1	Pref_1_Staff	2	0.0250
Minimal walking distance to concept 1	Pref_1_Stud	3	0.0750
Minimal walking distance to concept 2	Pref_2_FS	4	0.0125
Minimal walking distance to concept 2	Pref_2_Staff	5	0.0625
Minimal walking distance to concept 2	Pref_2_Stud	6	0.0250
Percentage of restaurant seats usable as working place per restaurant seat	Pref_3_FS	7	0.0500
Percentage of restaurant seats usable as working place per restaurant seat	Pref_3_SI	8	0.1250
Percentage of restaurant seats usable as working place per restaurant seat	Pref_3_Stud	9	0.0375
Acoustics	Pref_4_FS	10	0.0500
Ambiance	Pref_5_FS	11	0.0500
Restaurant location (floors)	Pref_6_Stud	12	0.0500
Accessibility (number of doors)	Pref_7_Stud	13	0.0250
Walking distance within building	Pref_8_Stud	14	0.0375
Diversity	Pref_9_Staff	15	0.0625
Coziness	Pref_10_Staff	16	0.1000
Findability	Pref_11_SI	17	0.1250

If the *state vector* is known, the following seventeen functions convert the decision variable value per decision variable into a preference score.

Pref_1_FS

Syntax `Pref_1_FS(VariableValue)`

Return value Given a decision variable value, this function returns the corresponding preference score for decision variable 1 for decision maker Faculty Secretaries.

*Pref_1_Staff*⁶⁴

Syntax Pref_1_Staff(VariableValue)

Return value Given a decision variable value, this function returns the corresponding preference score for decision variable 1 for decision maker Staff.

Pref_1_Stud

Syntax Pref_1_Stud(VariableValue)

Return value Given a decision variable value, this function returns the corresponding preference score for decision variable 1 for decision maker Students.

Pref_2_FS

Syntax Pref_2_FS(VariableValue)

Return value Given a decision variable value, this function returns the corresponding preference score for decision variable 2 for decision maker Faculty Secretaries.

Pref_2_Staff

Syntax Pref_2_Staff(VariableValue)

Return value Given a decision variable value, this function returns the corresponding preference score for decision variable 2 for decision maker Staff.

⁶⁴ Staff is referred to as works council in the other chapters

Pref_2_Stud

Syntax Pref_2_Stud(VariableValue)

Return value Given a decision variable value, this function returns the corresponding preference score for decision variable 2 for decision maker Students.

Pref_3_FS

Syntax Pref_3_FS(VariableValue)

Return value Given a decision variable value, this function returns the corresponding preference score for decision variable 3 for decision maker Faculty Secretaries.

Pref_3_SI

Syntax Pref_3_SI(VariableValue)

Return value Given a decision variable value, this function returns the corresponding preference score for decision variable 3 for decision maker Project Manager Social Innovation.

Pref_3_Stud

Syntax Pref_3_Stud(VariableValue)

Return value Given a decision variable value, this function returns the corresponding preference score for decision variable 3 for decision maker Students.

Pref_4_FS

Syntax Pref_4_FS(VariableValue)

Return value Given a decision variable value, this function returns the corresponding preference score for decision variable 4 for decision maker Faculty Secretaries.

Pref_5_FS

Syntax Pref_5_FS(VariableValue)

Return value Given a decision variable value, this function returns the corresponding preference score for decision variable 5 for decision maker Faculty Secretaries.

Pref_6_Stud

Syntax Pref_6_Stud(VariableValue)

Return value Given a decision variable value, this function returns the corresponding preference score for decision variable 6 for decision maker Students.

Pref_7_Stud

Syntax Pref_7_Stud (VariableValue)

Return value Given a decision variable value, this function returns the corresponding preference score for decision variable 7 for decision maker Students.

Pref_8_Stud

Syntax Pref_8_Stud (VariableValue)

Return value Given a decision variable value, this function returns the corresponding preference score for decision variable 8 for decision maker Students.

Pref_9_Staff

Syntax Pref_9_Staff (VariableValue)

Return value Given a decision variable value, this function returns the corresponding preference score for decision variable 9 for decision maker Staff.

Pref_10_Staff

Syntax Pref_10_Staff (VariableValue)

Return value Given a decision variable value, this function returns the corresponding preference score for decision variable 10 for decision maker Staff.

Pref_11_SI

Syntax Pref_11_SI (VariableValue)

Return value Given a decision variable value, this function returns the corresponding preference score for decision variable 11 for decision maker Project Manager Social Innovation.

The final function

IsFeasible

Syntax IsFeasible(StateVector)

Return value This function returns the value 1 if the state vector meets all constraints, i.e. is feasible and 0 if the state vector does not meet all constraints.

The constraints are given in [Figure 5.20](#).

In appendix F the MatLab source is included for the decision variable Minimum walking as an example. In appendix G the functions are elaborated upon. At the end of this appendix a table is given showing the relation between the different numbers.

7.1.3 Optimization tool

After this pilot was finished, a search algorithm was developed by Barzilai in 2014. This algorithm has been tested on the pilot's data. Firstly, the search algorithm is explained, followed by the results of the search algorithm and lastly the evaluation of the results.

The search algorithm

The search algorithm (Barzilai, to be published) searches for an optimum state vector, i.e. alternative, based on the overall preference score.

The search algorithm finds a local optimum. A local optimum is a solution that is better than any other feasible solutions in its immediate, or local, vicinity (Ragsdale 2008, p. 342). However, a given local optimal solution may not be the best possible solution, or global optimum, to a problem.

Results of the search algorithm

The search algorithm generated six vector states, i.e. alternatives, with a substantially higher overall preference score than the alternative as designed by the decision makers (see [Table 7.2](#)).

Alternatives 1 and 2 scored higher than the other four alternatives and were the *local optimum*. In this table next to these six alternatives, two alternatives are presented which served as reference. Alternative 7 was the best alternative the stakeholders designed. This alternative has been given an overall preference score of 100 by Barzilai in this comparison. Alternative 8 on the other hand was an alternative with a very low overall preference score and this has been given an overall preference score of 0 by Barzilai in this comparison. Note that, Barzilai's overall preference scores therefore differ from the overall preference scores from chapter 5.

TABLE 7.2 Overall preference scores state vectors found by search algorithm

# state vector	overall preference score
1	1.417.909
2	1.417.909
3	1.414.039
4	1.407.461
5	1.395.782
6	1.395.782
7	1.000.000
8	0

Evaluation of the results

The six alternatives as found by the search algorithm (numbers 1 to 6) were evaluated by determining their feasibility. As explained in 7.1.2, an alternative is infeasible if a subset, i.e. one or more food facilities, has a state that is infeasible.

The *state vectors*, i.e. alternatives, are shown in the first column in [Figure 7.4](#) and the sixteen food facilities are depicted in the first two rows. A red cell indicates that the state of this food facility is infeasible. As can be seen, all six state vectors are infeasible.

The infeasibility of a state vector can be caused by different reasons. State vector 1, for instance, has seven food facilities (numbers 4, 6, 7, 10, 11, 15 and 16) with an infeasible state. For example, food facility 7 is the coffee corner in the library which in this alternative has a concept *large*; due to the size of the coffee corner it is impossible to accommodate a food facility of concept *large* here. Therefore, this is infeasible. In fact, only 73 combinations out the 192 (12 times 16) are possible (38 %) as is shown in [Figure 7.3](#).

# alternative	food facility																
	1	2	3	4	5	6	7	8	9	10	11	12	13	14	15	16	
1				red		red	red			red	red					red	red
2			red	red		red	red				red	red				red	red
3				red		red	red			red	red				red	red	red
4			red	red			red	red			red	red			red	red	red
5				red			red	red			red	red			red	red	red
6			red	red		red	red	red			red			red		red	red

FIG. 7.4 Feasibility of the state vector (red = infeasible and grey = feasible)

In contrary to the search algorithm, the stakeholders were only presented with the feasible interventions per food facility. Therefore, they only needed to check the feasibility of the alternative with respect to the constraints.

In this pilot, the algorithm (step 5b) was not able to generate a local optimum with a higher overall preference than the best alternative the decision makers designed (step 5a). The reason for this was that a subset of the alternatives was infeasible. The feasible set of alternatives could not be characterized mathematically. This means, that a characterization of the feasible set is not available to the algorithm. The feasible alternative made by the group decision makers is the best alternative.

7.2 Pilot study 2: TU Delft's lecture halls⁶⁵

The model for this pilot used the generic set up and structure as discussed in paragraph 4.5. However, this model differed from the generic model in one way because of the type of problem that is addressed in this pilot. In paragraph 5.2 it has become clear that the lecture halls coped with the following four problems:

- 1 The current supply of lecture halls did not meet present-day requirements with regard to facilities and capacity;
- 2 The university started a new curriculum the year after the pilot, which led to a changing demand for lecture halls;
- 3 There were too few types of educational facilities to accommodate this changing demand;
- 4 The current supply was used ineffectively.

This means that the model established a relationship between the demand for educational space and the supply of lecture halls. In order to model this relationship PAS was not sufficient and two extra requirements needed to be met:

- 1 The model must be able to make a timetable based on the educational demands for a certain amount of lecture halls;
- 2 The user must be able to incorporate time constraints per activity in order to make the timetable representative.

Next to PAS linear programming (LP) was used to fulfil these requirements (Valks, 2016, p.53).

7.2.1 Model's structure

The model's structure is explained with a conceptual model. The conceptual design shows the relationship between PAS and the timetable allocation made by LP (see **Figure 7.5**) The key concepts for the conceptual model are the design space and the optimum alternative.

⁶⁵ This paragraph is based on Valks (2012, pp. 53- 55).

The primary objective in LP is to find a optimal timetable solution in the design space based on a single objective function. PAS is used to create a design alternative for the portfolio of lecture halls based on the preferences of stakeholders and to evaluate the timetable solution generated by LP. The primary objective in PAS is to design an optimum alternative with the highest overall preference score.

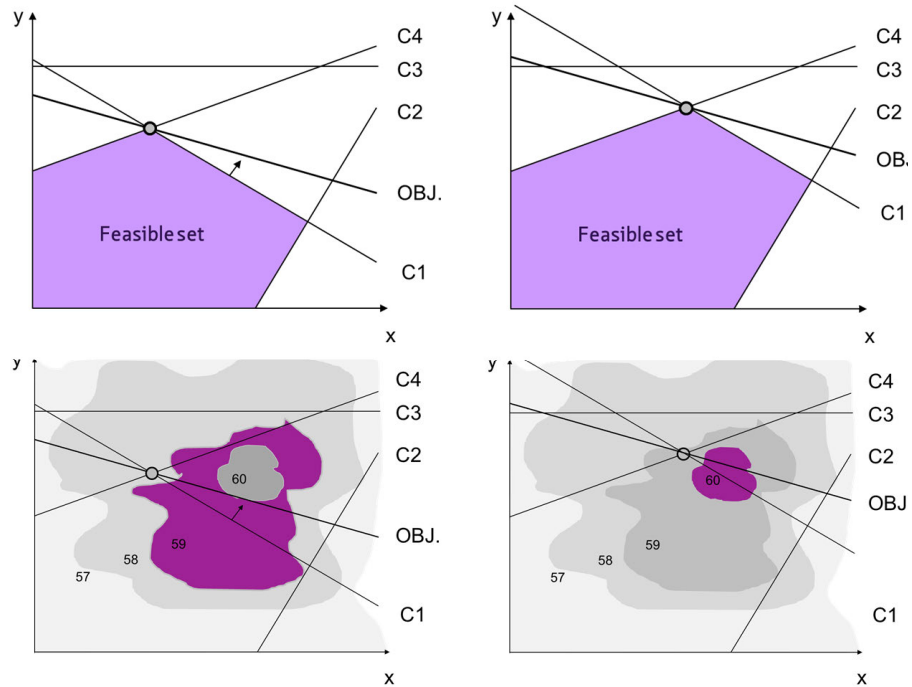

FIG. 7.5 Models' structure; combining PAS and LP Note adapted from Valks, 2012, p. 54. In the two upper figures a constraint is modified to enlarge the set of feasible solutions; in the two lower figures the grey areas depict the overall preference score of the alternatives and enables the decision maker to choose the best one. The circle depicts the best alternative in LP given the objective (OBJ).

In order to optimize the timetable allocation and thus achieve a higher overall preference score, the decision makers are able to influence the design space in two ways. First of all, the decision makers can modify a number of constraints that enlarge the design space, i.e. the feasible set of solutions. This means that the educational demands for a certain amount and/or type of lecture halls changes. It is than possible that this set has a design alternative with a higher preference score. Secondly the decision makers can alter the design space by designing an alternative in PAS. In this alternative the decision makers by choosing certain interventions have

changed the characteristics of the lecture halls and thus the supply of lecture halls. It is than possible that the design space has enlarged and that this set has a design alternative with a higher preference score (see **Figure 7.5**).

Different alternatives would have been chosen based on PAS and LP with a different overall preference score. Left top: circle with overall preference score of 58 and with PAS left bottom one of the alternatives in the feasible set and in the purple area with overall preference score 59. If the feasible set is enlarged the following happens, in the right top the circle with overall preference score of 59 and with PAS right bottom an alternative in the feasible set and in the purple area with overall preference score 60.

Because in this pilot it was impossible to design alternatives solely based on PAS, LP was needed to make a timetable based on the educational demands for a certain amount of lecture halls and to incorporate time constraints per activity. The timetable model in LP is subject to the same limitations as LP with negotiable constraints. However, within the timetable design space the decision makers are better equipped with PAS to select an alternative with a higher overall preference score (Valks, 2016).

7.2.2 Model's Formulas

The formulas of this model can be found in Valks (2013, pp. 54-59).

7.3 Pilot study 3: Oracle's office locations

The model for this pilot used the generic PAS model as discussed in paragraph 4.5. However, this model also differed from the generic model because an additional requirement was set. In order to compare PAS results with the original study, the model needed to calculate the preference score per decision variable for each of the locations and an overall preference score per location.

This paragraph is based on De Visser (2016, pp. 70-71, 76).

7.3.1 Model's structure

The model consisted of two parts:

- 1 Overall preference score design alternative;
- 2 Individual location preference scores.

Each of the parts is explained separately.

Overall preference score design alternative

The procedure to calculate the overall preference score used four steps and is shown in **Figure 7.6**. There was one input variable for the procedure that represents the design alternative. This variable was a list of all locations indicating respectively that a particular location was or was not included in the design alternative by the decision makers. In **Figure 7.6** this input is indicated by a X, this input is used in all functions. The functions are:

- 1 A function calculates the average design variable value for each decision variable (variable) based on the location data for this criterion;
- 2 A function calculates for each variable the preference score based on the design variable value and the preference points for this variable;
- 3 A function calculates the overall preference score for that particular portfolio design by combining the variable preferences score with the variable- and stakeholder weights;
- 4 A function tests the feasibility of the design alternative for all design constraints (De Visser 2016).

The output of the model is presented in the user interface (see paragraph 6.3).

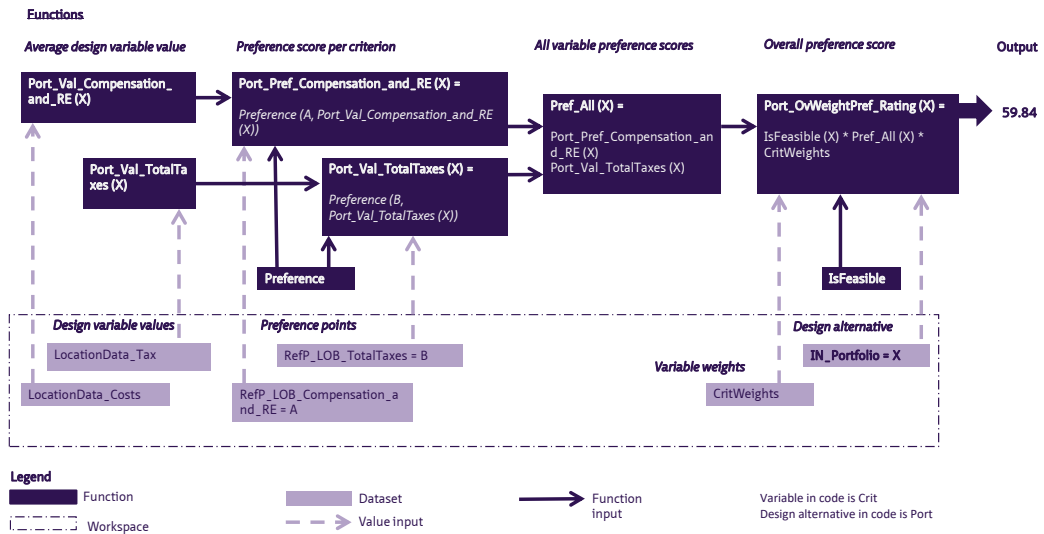

FIG. 7.6 Model structure overall preference score Note adapted from De Visser, 2016, p. 70

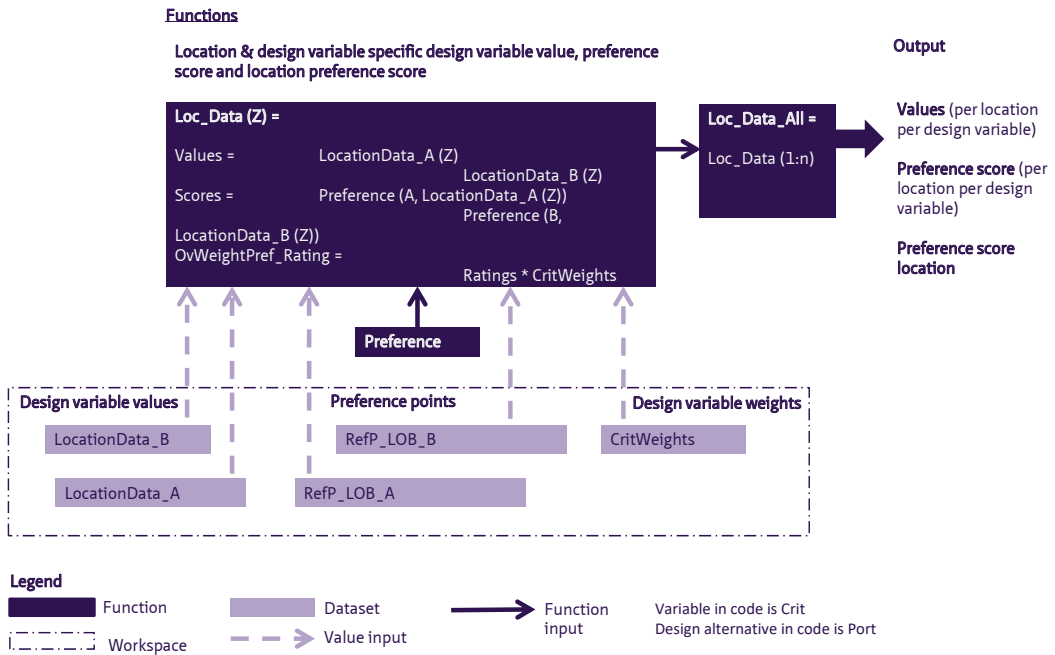

FIG. 7.7 Model structure individual location preference score Note adapted from De Visser, 2016, p. 71

Preference score per location

This part of the model is additional to the generic model. It returns all individual design variable values and preference scores per design variable per location (see Figure 7.7). Based on these values, it calculates the overall preference score per location. The values and preference scores per design variable for each location remain the same in each workshop, Therefore, they were provided separately to the stakeholders to be used during the workshop generating alternatives (step 5). Next to that, a location ranking is produced that shows the locations and their overall preference score per location in descending order. This output is compared to the outcome of the initial study (see paragraph 5.3) (De Visser, 2016, pp. 70-71).

This model could be made because in this study all of the design variables were related to a single location. In the other pilots, design variables were formulated that set a requirement for the portfolio as a whole. In those pilots it is impossible to calculate the overall preference score for the underlying object.

7.3.2 Model's Formulas

The formulas of this model can be found in De Visser (2016, pp. 118-122).

7.3.3 Model's optimization tool

During the pilot study it became clear that this pilot was of such complexity that it was possible to generate all feasible design alternatives with a brute force approach. The complete pilot comprised of a total of 3.365.856 possible design alternatives. However, due to the design constraints a design space of only 4.480 feasible design alternatives remained. The alternatives could be generated by a brute force approach. With the use of a mathematical function the feasible alternatives were found and their overall preference score was calculated. The design alternative with the highest overall preference score is the global optimum (De Visser, 2016, p. 76).

7.4 Pilot study comparison and conclusion

In this chapter, it is shown that the system engineers were able to build mathematical models for each of the three pilots. Only in the second pilot, next to the PAS mathematical model, linear programming was needed as addition to incorporate time tabling. With these models, as has been shown in chapter 5, in each pilot, the decision makers were able to design (step 5a) and select (step 6) an *alternative* with a higher overall preference score than in the *current situation*. In each pilot more alignment have been achieved between CRE and the organization.

In addition to this, an optimization tool has been used in two pilots (step5b) with the aim to design an optimum alternative and achieve even more alignment. In the third Oracle pilot the optimization tool was successful. The optimization tool generated a *global optimum*. This means that design alternative (step 5b) has the highest overall preference score possible, i.e. also higher than the alternative the decision makers designed (step 5a). Due to the nature of the pilot the *brute force approach* could be used.

In first TU Delft pilot for the food facilities pilot, the algorithm (step 5b) was not able to generate a local optimum with a higher overall preference than the best alternative the decision makers designed (step 5a). The reason for this was that a subset of the alternatives was infeasible. The feasible set of alternatives could not be characterized mathematically and was not available to the algorithm. The feasible alternative made by the group decision makers is the best alternative.

In the second pilot, it was impossible to design alternatives solely based on PAS. Linear programming was needed to make a timetable based on the educational demands for a certain amount of lecture halls and to incorporate time constraints per activity. The timetable model in LP is subject to the same limitations as LP with negotiable constraints. However, within the timetable design space the decision makers are better equipped with PAS to design an alternative with a higher overall preference score.

In the third pilot, next to the overall preference score for the whole corporate real estate portfolio under investigation, it was also possible to calculate the overall preference score of the underlying object, i.e. a location. This gives the decision makers valuable extra design information. However, this is only possible if the decision makers do not formulate decision variables that set a requirement for the portfolio as a whole.

8 PAS evaluation

chapter 2	CRE alignment state of the art and scientific gap
-----------	---

**Preference-based Accommodation Strategy (PAS)
design and decision approach**

Developing PAS		Testing PAS			Evaluating PAS
chapter 3	chapter 4	chapter 5	chapter 6	chapter 7	chapter 8
fifteen basic concepts and definitions from decision, design and management theory	2nd procedural rationality	steps			steps
	3rd structural rationality		stakeholders & activities		stakeholders & activities
	1st substantive rationality			model	model

chapter 9	Reflecting upon PAS
-----------	---------------------

chapter 10	Conclusions and recommendations
------------	---------------------------------

8 PAS evaluation

In this chapter the evaluation of PAS will be discussed. The use of PAS has been extensively reported in chapters 5 (steps), 6 (stakeholder & activities) and 7 (mathematical model). The use of PAS has been successful, this means that stakeholders are able to use PAS. In this chapter the evaluation of the stakeholders of PAS is discussed. This answers the question if the stakeholders want to use PAS.

Recall, that PAS comprises of steps, stakeholders & activities, and mathematical models. The activities consist of a sequence of interviews and workshops and a simultaneous design and calibration of the mathematical model. The pilots resulted in a final design alternative and a final mathematical model.

The evaluation is given per pilot study and this chapter has the following structure:

- TU Delft pilot for the food facilities in paragraph 8.1;
- TU Delft pilot for lecture halls in paragraph 8.2;
- Oracle's pilot for office locations in paragraph 8.3;
- Pilot comparison and conclusion in paragraph 8.4.

In each of these paragraphs, the four types of measurements that Joldersma and Roelofs (2004) use, will be addressed.

In the first subparagraph the stakeholders' evaluation is discussed. Here, the first three measurements were addressed: (1) experiences with PAS, (2) attractiveness of PAS and (3) participants' observations on effectiveness of PAS. In general, it is not indicated which particular stakeholder gave feedback if their role in the organization was not relevant for the remark. Only in cases where the role and background of the stakeholder was relevant to their remarks, it is indicated which particular stakeholder gave these remarks. In the second subparagraph, the fourth measurement, namely the observers' perceptions of the effectiveness of PAS is reported.

In the text, the frequently mentioned positive aspects and areas of improvement are underlined and will be used in the conclusion and pilot comparison.

8.1 Pilot study 1: TU Delft's food facilities

8.1.1 The stakeholders' evaluation

In this pilot, both workshops were group workshops with all stakeholders. In total six different stakeholder groups were involved, consisting of eleven different persons, with whom in total twenty interviews were held (see appendix H).

Arkesteijn et al. (2017, pp. 258-259)⁶⁶ reported the following evaluation for this pilot:

Initial attitude towards PAS and the pilot

In the first interview, apart from giving input for the first four steps of PAS, the participants were asked to give a first evaluation of the procedure. The answers from the interviewees in combination with our observation painted the following picture: most of the stakeholders were open to the procedure and willing to participate. One participant questioned the possibility to include emotions into the model and one of the stakeholders was suspicious of the model and questioned whether it could work as intended.

Experience with PAS

After the first workshop most stakeholders were mainly positive. The item that was mentioned most often in all interviews was the possibility of iteration⁶⁷ in the model. Iteration made it possible for them to formulate the decision variables as they intended. Two other traits of the procedure (the group interaction and the transparency of process) were also highly valued. The use of the model and their positive experiences with it generated trust in the model. After the second workshop

⁶⁶ For the ease of reading, the section numbers of the paper are not used in this paragraph. Furthermore, the first paragraph of the published section 7 is not included here and the last section about the evolving perceptions is added.

⁶⁷ As reminder, the frequently mentioned positive aspects and areas of improvement are underlined and will be used in the conclusion and pilot comparison.

a result of an overall preference score of 95 was achieved. Stakeholders indicated that they had not expected to reach such a high score. One of them specified that, Therefore, he had not been tempted to use any strategic behavior.

The second workshop confronted us with a problem: the concepts food facility middle and large were unclear. The Facility Management and Real Estate (FMRE) department intended the food facility middle to be a coffee corner, without the traditional hot servings at lunch, while other participants preferred it to include hot servings. It was agreed that the results of the model would only hold under the condition that concept middle would be the latter option.

Attractiveness of PAS

The stakeholders found the experienced interaction, iteration and transparency attractive mainly because they could give and determine their own input. Their main attitude was one of satisfaction. However, they were encouraged to give feedback to improve the approach and/or model. They have been especially critical of the design interface of the model. It was not always easy for them to keep an overview, although the model helped them to do so. It seems that this was caused by several factors for different people. Two participants wanted to understand more of the backend of the model, i.e. how the relationships were defined between the variables. This would help them to define their decision variables and curves better and in the end accept the model and its results. Another participant stated that the model is less attractive because it is not operated by the stakeholders themselves and suggested that this might need more time.

Perception of effectiveness

The procedure has been described as very effective. It does not take much time, is to-the-point and much more result oriented than similar processes. The ... design⁶⁸ of the alternatives is seen as a trial-and-error process whereas the effects of the interventions are clear: they function as input to realize an optimal solution. This process deepens the conversation about the alternatives. Another user acknowledges the transparency of the model, the speed of its execution, and especially, the clarity of which demands have or have not been taking into account in the chosen alternative. One participant wondered whether the expected effects could indeed be achieved in practice. (Arkesteijn et al., 2017, pp. 258-259).

⁶⁸ In the paper I referred to self-design. In this thesis, it is referred to as design.

It showed during the evaluation that stakeholders besides giving remarks about the perception of the effectiveness also commented on the degree of efficiency of PAS.

Evolving perceptions

Two stakeholders expressed their initial concerns with the method and it is interesting to see how their perceptions have evolved. The stakeholder that doubted whether emotions, i.e. qualitative aspects, could be integrated into the method was maybe even the most enthusiastic stakeholder at the end. The pilot study fully convinced him that his doubts were unfounded and it was indeed possible to give quantitative measures to qualitative aspects. The stakeholder that indicated that the approach could be overly transparent and too complex, indicated he was pleased that the approach led to such an optimal solution (overall preference score of 95). He was surprised, though, with the low overall preference score for the current facilities (43). He also noted that scientists as stakeholder group should have been involved, even though the employees were represented by the works council. However, this stakeholder still expressed concerns about the use of the model, because he assumed it is not always possible to come to an agreement and therefore, wonders whether a check will be made of the end result. Although stakeholders indicated that assigning preference scores is not an easy task initially, in the end they were able to do so because of the iteration between the alternatives they designed, and the insight they were given in the effects of their decision variables.

8.1.2 **The observers' evaluation**

The facilitator and system engineers' perception of the effectiveness was that the approach has been effective. The stakeholders in the pilot succeeded in designing an alternative real estate portfolio with a higher overall preference score. They have reached a score of 95, which we never expected to be possible at the start of the project. This was possible because in this pilot no or not many opposite requirements have been set .

The facilitator and system engineers stated that the effectiveness of the approach is substantial, nevertheless the approach can be fine-tuned. They observed four types of improvements. Firstly, that the amount of and content in the design interfaces of the mathematical model can be enhanced. The facilitator and the systems engineers supported the stakeholders to read the interfaces and find the interventions with the most effect. After the initial help, most stakeholders were able to suggest interventions independently. Maybe a different interface could be of help here.

Secondly, the nature of the approach should be explained more clearly at the start of the process. During the pilot study some of the stakeholders, on some occasions, stated that PAS was objective and/or the called the nature of the approach rational. Their statements had a positive connotation as opposed to when some people spoke about something being 'subjective'. The 'objective' is to be strived for, while for some the 'subjective' needed to be avoided. The PAS, especially the mathematical model, is based on logical calculations. This gave the stakeholders the impression that this approach was objective and rational. PAS is subjective by definition, since all decision variables, their curves, and weights are linked to a specific stakeholder (i.e. subject). Therefore, 'objective' was interpreted as actually meaning more 'transparent'. During the last interview, it became clear that most stakeholders understood this issue, however, it might be beneficial to find a way to explain this more clearly at the start of the process.

Thirdly, at the start of the project, the FMRE department expected that some stakeholders would set decision variables that would lead to a completely different solution. They expected to have three food facilities *large* on campus and hardly any food facilities of the concept *middle*. However, none of the stakeholders set a decision variable, for instance the possibility to have random spontaneous encounters between members of the whole organization, which could have resulted in less restaurants , mainly of the concept *large*.

Fourthly, next to the pilot study, the FMRE department ran a project where a consultant formulated a vision for the future of the food facilities. However, FMRE indicated that it was not possible to involve this consultant as stakeholder in the pilot, so that he could translate this vision into decision variables, curves and weights. The FMRE department indicated that they will integrate the results of this pilot and the study of the consultant in the future. In order for PAS to be as effective as possible, it is important to involve all relevant stakeholders to reach the best possible solution. However, not involving this consultant may have influenced the validity of the end result for this particular problem, but it did not interfere in testing the effectiveness of PAS itself.

8.2 Pilot study 2: TU Delft's lecture halls

In this pilot, the first workshop was held individually and the second workshop was with all stakeholders combined. For this pilot in total six different stakeholders groups were involved, consisting of twelve persons, who participated in six workshops, and with whom twenty-three interviews were held (see appendix H). It should be noted that three specific persons were involved both in the first and second pilot. These were the Executive Board as subject owner, the FMRE department and the student council. The Executive Board indicated boundary conditions only, and therefore, was interviewed twice, at the start and the end of the process. This means the Executive Board was not involved in the workshops and intermediate interviews. Both the student council and one of the employees of FMRE indicated that they were able to have a quick start due to previous experience, they were also able to compare the two (slightly) different approaches and problems.

8.2.1 The stakeholders' evaluation

Initial attitude towards PAS and the pilot

Initially, only two stakeholders reacted to this question in the first interview. The reason for this might be that the pilot was more complex and therefore, less time remained for the evaluation. At the end of the first individual workshop most stakeholders gave their first impression and called the program: magnificent and very interesting. One of the 'repeating' stakeholders expected it to be difficult to link the preference scores to concrete characteristics of the lecture halls. However, although it is difficult, this stakeholder also valued especially this aspect because it makes stakeholders work towards an end result.

Experience with PAS

The interviews and workshops are generally experienced very positively by the participants. All the participants have indicated that the workshop helped them to gain a deeper insight into the problem, their own decision variables, or those of others. The student council, for instance, understood what teachers wanted and why. The teachers commented that it was very worthwhile to involve the different stakeholders and to understand their needs. Another stakeholder commented that the decision variables of other stakeholders were surprising, and that they gained

more insight in some of the conflicting decision variables. One stakeholder even indicates that using curves to express their requirements in numbers is a huge advantage because it enables the stakeholders to be confronted with the effects of these requirements. Most stakeholders indicated they valued that during the workshop they saw what the effect of their choices was.

The involvement of more stakeholders gave one of the stakeholders the reassurance that 'all relevant decision variables' are taken into account. For example, the stakeholders also realized that there is uncertainty about how education will evolve, and what that means for the necessary facilities. One of the stakeholders therefore, mentioned that next to the current stakeholders it would have been worthwhile to involve another stakeholder with more specific knowledge on the 'future of education'.

The stakeholders value the use of tangible decision variables and indicated that "without the model such a process is less concrete". It helped them to understand the question behind the question. One of the stakeholders was pleased with the pilot because "he was forced to think in what he refers to as 'key performance indicators' instead of ideas". Although this also has led to some uncertainty, especially this translation of ideas into curves made the matter more concrete and prevented him to stay at the level of future images.

The stakeholders were especially positive about the second group workshop; bringing people together, searching together for a good solution, the interaction with each other and the model were all aspects that were rated positively. Some participants also recognized the importance of iteration in the process. The first individual workshop in general was rated less positively because they either did not understand the goal of the workshop or missed the discussion with other stakeholders, although, some participants recognized that they had more time to focus on their own decision variables and understanding the model.

In this stage of the pilot, only one stakeholder is critical of the PAS, he has the impression that the model is too theoretical ⁶⁹ and the PAS does not reflect reality. He gives an example to substantiate this. For instance, he sees alternative solutions for the problem of recording lectures. According to him, this can also be done with a mobile unit. Although this is technically correct, the decision variable to record lectures was not his own decision variable. This means, that he had no say about

⁶⁹ This aspect is not taken into account into conclusion because this stakeholder at the end of the process favored the approach.

the decision variable of another stakeholder. The stakeholder who defined this specific decision variable, determined that the mobile units did not suffice. Therefore, based on these examples, it could not be concluded that the approach does not reflect reality.

Attractiveness of PAS

The attractiveness of the method is rated highly by the participants. Stakeholders use different positive words to describe the approach; useful, attractive, visual, interesting, informative and teachable . The way of presenting the PAS is experienced as positive. Similar answers were given as in the former section but some will be elaborated upon.

They found the process of interviews and workshops⁷⁰ helpful – the interviews were a more attractive way to think about what you want than, for example, questionnaires, and the workshops were attractive when multiple participants are brought together to discuss the problem. Another attractive aspect is the use of curves. The participants described determining curves as easy, and one participant remarked that the curves result in fewer emotions in the discussion and more focus on the collective interest. What they generally found difficult, is to assign preference scores; they had to estimate their preference when a certain value is achieved. That is why the *iteration* with the possibility of adjusting decision variables is so important. Designing interventions was perceived to be more difficult (Arkesteijn et al, 2017).

“Making curves is easy and the possibility to adjust them and make them more realistic after having the workshop makes the method so strong”.

The attractiveness of the approach is that by bringing stakeholders together in the second workshop, a common frame of reference is made. This potentially avoids unnecessary discussion and makes different stakeholders less prone to only hold on to their own decision variables. Other than that, both the FMRE and the Education and Student (E&S) Affairs department stressed the positive interaction in the joint search towards a solution.

The interface is described as easy to use, visual and simple. One of the ‘repeating’ stakeholders complimented us on the interface “it looks good and even easier (than the first pilot)”. If the interface is actually easier, the stakeholder can only assess if

⁷⁰ The interviews are linked in conclusions to insight in decision variables and the workshops to group interaction.

he would operate the model himself. One stakeholder missed the creative part in which the stakeholders can search solutions that are not part of the model.

Perception of effectiveness

When asked about their perception of the method's effectiveness, most participants responded very positively. Some of them thought that it helps to reach an agreement⁷¹ on an end result and that they have understood quicker why certain choices are made. Some stakeholders explicitly indicated that the approach will support them to make a better plan. One of the stakeholders indicates that he "believes a good solution can be reached with the model and expects that this approach will help to make better substantiated (investment) decisions". And especially valued was the cumulative insight in the effects, although not all stakeholders were able to easily see this '*cumulative*' effect. Two of them found it difficult to assess the effectiveness of the model.

Suggestions to improve the perceived effectiveness

After the last workshop the stakeholders accepted the results of the design process. In the last interviews, some of the stakeholders took the opportunity to change their input (decision variables, curves and/or weights). By doing so they fine-tuned their input. The results of the pilot study were taken into account by FMRE and E&S Affairs in the development of the lecture halls, but not implemented as such. If the results were to be implemented, another iteration round could be useful.

The stakeholders gave suggestions how to make the model and its input more realistic. Firstly, they suggested to involve more stakeholders and also different types of stakeholders (with more knowledge of the future of education). Secondly, some suggested to add more types of lecture halls (next to the large lecture halls also the medium sized ones). Thirdly, it would benefit the model to have better cost estimates. Fourthly, the teachers' representative is in his regular work very familiar with computer algorithms and therefore, suggested to use an algorithm⁷² that could replace the design to find the optimal solution. Fifthly, adding a way to see the sensitivity of the parameters that are used; could improve the approach as well. Sixthly, one of the stakeholders indicated that the results would improve

⁷¹ This aspect is linked to result oriented in the conclusions.

⁷² Whereas an algorithm can have the meaning of a step by step approach (see chapter 2), here the stakeholder refers to an algorithm performed by a computer.

if the stakeholders were given more time for the process. Lastly, two stakeholders indicated that they would like to be able to use the model themselves during the process. To increase the effectiveness of PAS, the stakeholders gave the abovementioned seven particular suggestions.

Perceived effectiveness in comparison to other approaches

During the evaluations some stakeholders spontaneously compared PAS with other approaches, although the study was not set up to compare PAS systematically to other approaches. Below, the different comparisons that were made are elaborated upon. When looking at the time spent and the results of the process, most participants responded that the process is certainly efficient compared to others, while some felt it took more time than similar processes. One of them compared PAS (1,5 day in total) to an approach in which he was involved in an one-hour interview. In that interview he was asked to give his vision and ideas but did not need to formulate concrete decision variables and make design alternatives. Whether or not the extra time spent is worth it depends on the outcome of the last workshop.

“The approach is quick. Only after four months [duration] a result is achieved with many stakeholders. Compared to other processes this is very effective. The process is quicker, more concrete and more insightful”.

One of the stakeholders states that “PAS is a better way to work together than the current FMRE approaches”. Another stakeholder compared PAS to meetings, and indicated that it is more difficult to understand other stakeholders’ decision variables in a meeting. In that approach, communication is often between the FMRE department and each of the stakeholders individually. The fact that in PAS the stakeholders meet as group, was valued more. One stakeholder was curious to know how the PAS compared to another study about lecture halls that took place, in the same time period (Kraak & Netten, 2013). Initially, he saw the research projects almost as opposites. Whereas, the latter research was qualitative the PAS approach was rather quantitative. However, later in the process this stakeholder indicated that his evaluation changed in two ways: in PAS he valued the connection between the quantitative and qualitative, and he stated – as has been shown in the experiences - how important the translation into concrete decision variables was. All stakeholders that compared the PAS to another approach, favor PAS.

At the end of the pilot, the results were presented to a new member of the Executive Board. This board member was not involved at the start of the research but was responsible for E&S Affairs for many years. Therefore, she was familiar with the subject matter and explained that the problem of lecture halls is a longstanding issue

and that many of the former research projects missed something. A former research project focused on the Directors of Educations' vision on future developments which resulted in qualitative pronouncements and vision but lacked concrete interventions. Another research project focused on the teachers' vision on facilities the lecture halls needed to have, resulted in concrete solutions but lacked the connection to the strategic level. PAS is "exactly what is needed, because it links *concrete interventions to strategic objectives*".

Role and use of the facilitator and system engineer

The FMRE department acknowledged the role of the facilitator and the system engineer as positive. They valued their guidance during the use of the model, while staying neutral. Especially for this reason FMRE department indicated that they prefer to make use of a facilitator, instead of taking this role themselves. Even though, the model looks easy to use from the stakeholders' point of view, the backend of the model is complicated. Therefore, FMRE also indicated that a system engineer is needed to build the model.

Evolving perceptions

Two stakeholders were more critical at the start of the pilot, as we have seen above. For both a reflection is made how their perceptions have evolved over time.

The stakeholder that stated at first that the model was too theoretical and abstract, indicated in a later stage that it is a good step forward that the problem can be modeled. The model gives insight in the choice you make and what is really important. The involvement of different types of stakeholders is valuable. In the last interview he even said that he thought this [PAS] is the correct route for teachers'. The different way of approaching a problem has effect.

One of the involved Executive Board members who wondered whether this approach could be too transparent, was positive about the results that have been achieved in both the pilot studies. For the constraints he has given, he is interested in understanding the 'jumping point' in the model. The jumping point indicates when an alternative is feasible or not. It is understandable that this stakeholder is interested in this issue, because his constraints 'student satisfaction' and teacher satisfaction' are dependent on preference scores of these stakeholders. The subject owner was involved in the pilot only at the beginning and the end. Maybe it would have been better to involve the subject owner during the process as well, because this would have given him the ability to iterate his constraints. He would have learned about the jumping process during PAS. The stakeholder also suggests to use a hierarchy

in the interventions. Whereas this subject owner was positive about the results, this does not mean that he is convinced that the process should have this level of transparency. This means, that the evaluation of Executive Board members was not unambiguous. While this subject owner still is reserved about the desired level of transparency the new member of the Executive Board, on the other hand fully supports this way of working.

8.2.2 The observers' evaluation

The facilitator and system engineer's perception of the effectiveness of the method is that it is very effective, but that there is also room for improvement. When viewing the end result as a measure of effectiveness, the outcome shows that the participants succeeded in finding a combination of real estate interventions and scheduling interventions that improved the overall preference score from 58 to 69 (out of 100). Furthermore, because the model addressed both problems, it made participants think about trade-offs they would otherwise not consider. For example, the teacher present in the workshop asked himself: "would I prefer a lecture hall during day time more than a lecture hall in the evening that has all the amenities I need for my lecture?".

When viewing the effectiveness of the method from the stakeholders' point of view, the method is highly effective. The problem of designing an optimal portfolio of lecture halls is a complex problem that involves many stakeholders and, as we found in the interviews, is also entangled with the problem of designing an optimal schedule. The method gives the stakeholders the opportunity to present their preferences in an efficient way and to design solutions based on all stakeholders' preferences in a model. The traditional process is probably a series of joint meetings in which stakeholders reveal their preferences partially and in different ways. Then alternatives are presented that each stakeholder evaluates based on their own perception of how well that alternative meets their preferences. This process requires more meetings, more work on the part of the involved stakeholders and gives less insight to a stakeholder if the chosen solution actually meets their preferences.

The PAS process differs in many aspects from the processes these stakeholders were used to. Initially, most stakeholders are reserved in assigning their preferences in this way: they are concerned that if they make their preferences explicit that it will also mean that they are definitively captured. Once it is clear to them that they may adjust them at any point, this concern is removed. Furthermore, they are concerned that establishing their preferences might 'objectify' the process. Often in

the workshops it becomes more clear for stakeholders why it is so important that they have made their preferences explicit due to the discussion that ensues about trade-offs in the model and about their own preferences. A remark heard often is that the process has therefore become more 'objective' which we interpret as actually meaning more 'transparent'.

When viewing the effectiveness of the method from the system engineer's point of view the method is less effective than in the first case. The addition of a scheduling component to the model significantly increased the build time for the system engineer. Furthermore, the scheduling component has limitations to the scale of the solution that it can compute; hence, only a small scale simulation can be done for a university schedule and the schedule can only be optimized on one decision variable. This decreases the effectiveness of PAS which is specifically designed as a multi-decision variables method in order to design real-life real estate portfolios. It makes the model more complex and therefore, harder to understand for the stakeholders when compared to the first PAS pilot. In the workshop the model required more assistance from the facilitators: especially with regard to the scheduling interventions the facilitator was operating the model whilst discussing the effect of possible interventions with the participants, rather than letting the participants operate the model. Selecting real estate interventions could be done by the participants themselves.

Finally, in this particular case it was decided to do the first workshop individually per stakeholder in order to allow them to become more acquainted with the model. Although this did have an added value, it did reduce the opportunity to design alternatives as a group and learn from each other. With an extra joint workshop more time could have been spent on designing alternatives which would have led to a higher overall preference score. The maximum score achieved prior to the workshop by the system engineer was 79. A higher score was nearly impossible to achieve due to the trade-offs present in the model: optimizing on decision variables such as frequency rate and occupancy rate would worsen the result on the % of lectures in the own faculty, walking distance and amount of changes between buildings.

8.3 Pilot study 3: Oracle’s office locations

In this paragraph, the evaluation of third pilot study is presented. De Visser (2016) followed the same protocol for data collection in the interviews. However, different questions were used, because of the different nature of this pilot. De Visser not only used the design of alternatives by the stakeholders (step 5a) in the pilot but also an optimization tool (step 5b) as has been explained in paragraph 4.5 and chapter 7.3. When evaluating PAS including the use of this optimization tool, it could be different for the stakeholders because this tool belongs to the hard systems approach. Therefore, De Visser used a checklist based on (Riedel et al., 2010) to evaluate a decision support system and its development process. The checklists’ elements are more detailed than the ones of Joldersma and Roelofs (2004), but De Visser made links between both as shown in [Table 8.1](#).

TABLE 8.1 Checklist for evaluating DSSs and their development process Note adapted from De Visser, 2016, p. 89

Evaluation category (Joldersma & Roelofs, 2004)	Characteristics	Resulting effect (Riedel et al, 2011)
Experience	Stakeholder interaction (Van Loon et al., 2008)	system acceptance
	Iterative system development (Van Loon et al., 2008)	system acceptance
	Familiarize with backside of the system (Riedel et al., 2011)	trust in system
Attractiveness	Perceived control (Riedel et al., 2011)	system acceptance
	Complexity (Riedel et al., 2011)	system acceptance
	Calibrated variables (Van Loon et al., 2008)	trust in system
	Perceived usefulness (Riedel et al., 2011)	system acceptance
	Purpose (Riedel et al., 2011)	trust in system
	Perceived ease of use (Riedel et al., 2011)	system acceptance
	Justification of outcome (Riedel et al., 2011)	trust in system
Effectiveness	Clear system goal (Van Loon et al., 2008)	system acceptance
	Performance reliability (Riedel et al., 2011)	trust in system
	Justification of outcome (Riedel et al., 2011)	trust in system
	Participation & involvement of stakeholders (Riedel et al., 2011); user consultation (Van Loon et al., 2008)	system acceptance

This means that he uses different vocabulary in the evaluation as has been used in the first two pilots. At the end of this paragraph the pilot’s evaluation is summarized according to the evaluation aspects; experience with the approach, attractiveness of

the approach and its perceived effectiveness. In total two stakeholder groups were involved in this pilot consisting of three different persons. De Visser conducted in total two workshops and four interviews.

In this paragraph, the characteristics are underlined to guide to reader through the text instead of the positive aspects and areas of improvement as has been done in the two previous paragraphs.

8.3.1 The stakeholders' evaluation

De Visser (2016, p. 88) concluded that “In general, the stakeholders evaluated the PAS as very positively. They even indicated that the model is a great improvement over their current process and they are looking forward to be able to implement the tool in their actual decision making process”.

De Visser (2016, pp. 89-92)⁷³ reported the stakeholder evaluation as follows:

The stakeholders indicated that they felt very much *involved* in the development of the model by thinking about the right selection of decision variables and establishing preference curves. This made them accept the model and its outcome. They also think that the use of preference curves helped to develop their preferences and it better reflects the actual preferences. One of the [advanced planning] team representatives indicated that

‘She feels inclined to put more thought in fewer decision variables, which means a choice for quality over quantity.’

Both representatives of the [advanced planning] team indicated however, that due to the complexity of the PAS principles, i.e. thinking in terms of decision variables, preference curves and weights, the real challenge is to get the right people from the [line of business] involved that are able to understand the principles and have the time to provide the right information. A manual, explaining the principles of each step of the PAS, might be helpful to improve the understanding. Stakeholders experienced the *interaction* and combined effort in the process of establishing preference curves

⁷³ The long citations are displayed in purple. Besides this, De Visser marked certain words **bold**, in this thesis these words are marked italic. Textual alterations are: the word stakeholders is used instead of users and the abbreviations for organizational units have not been used as in the original text.

and decision variables weights as extremely helpful. This also helped to develop their preferences.

The stakeholders think that the current process contains sufficient *iterations*. Moreover, they found the iterative model development process and the workshops extremely helpful to understand the principles of the PAS and the model, which increased their acceptance.

As the representative of [line of business] 1 indicated,

'This [the PAS principles and model building process] gives a sense of analysis robustness to the user who is customizing the variables that will contribute to the final results.'

The effect of the current process is that the stakeholders have a positive *perception of their control* over the model, as they see the effects of their input. This partly resulted from their perception of involvement and the fact that a model has been developed with the right level of complexity.

The stakeholders have gained sufficient understanding of the *backside of the model*, during the workshops and through the explanation of the systems engineer, to trust the model and its outcomes. It made them understand how the model uses the physical location data to arrive at the preference rating. However, one of the stakeholders would be interested to develop more knowledge of the actual operations in Matlab.

In every model building interview and workshop, the *goal of the model* was recapitulated, in order to refresh this. According to the stakeholders' answers, the goal was clear at all times.

All stakeholders indicated that the final *model complexity* reflects the actual decision making process very well. Especially the improvements made in the model after the first workshop, by adding additional design constraints, helped to establish the right complexity level. This increases the users' model acceptance. The representative of [the line of business] 1 recognized that

'the good thing is that the model is flexible and just setting to 0% [weight red.] some of the variables, the complexity can be reduced if needed.'

Both representatives of the [advanced planning] team indicated that the *calibration of variables* at the end of the pilot study was sufficient. They both positively evaluated the flexibility in the procedure, which enabled adaptation of their input. One of them indicated that it was good to see the refinement of the model in the second workshop. Both aspects increased trust in the model.

The stakeholders' *perception of the usefulness* of the model is very positive as well. In general, all of them see it as a very useful tool that they would like to use in the actual location decision making process. They were specifically positive about the use of the preference curves to interpret the data, which results in a more refined interpretation and better representation of actual preferences than was possible in their original process. Also the stakeholders indicate that the optimization with the brute force function adds up to their positive perception of the usefulness. However, one of the representatives wondered whether there are graphical representations of the outcomes possible that enable presenting the output to executives more easily. The positively perceived usefulness is directly connected to acceptance of the model, according to one of them.

The stakeholders indicated multiple times that they trust the model. The fact that the model in the pilot study was custom made for the *purpose* it was used for, might have had a positive influence.

In terms of *ease of use* of the model, the representatives of the [advanced planning] team are divided to some extent. Both provided very positive feedback on the ease of use of the design interface, the feedback it provided on the locations selected and the constraints. Also designing and evaluating portfolio alternatives was easy enough. Together this increased their system acceptance. However, one representative indicated that in practice the ease of use would also depend on the amount and complexity of the back-end modelling that is required.

According to the stakeholders from the [advanced planning] team, the model *performs as expected* or even better. The expectations were mostly confirmed during the workshops with the model. Also the model outcomes are in line with the expectations that are based on the understanding of the model. Especially the fact that there is a large overlap in the top-15 of the location ranking from the PAS, with that from the original study increases the trust in the model.

The *justification of the outcome* in the design interface is evaluated as sufficient by the stakeholders. One of the [advanced planning] team representatives indicated that it would also help to increase the trust in the model from this perspective, when she would have an improved understanding of the model's back-end.

Experience, attractiveness and effectiveness

As each of the characteristics of the checklist is connected to one of the evaluation categories of Joldersma and Roelofs (2004), it can be deduced from the positive evaluations regarding these elements that the stakeholders had a positive experience with [...] PAS in this pilot study. Also they clearly find the resulting model attractive, as they indicate that it is very useful and easy to use. The stakeholders indicate that it better represents the preferences than the current process, it is flexible and works efficient in terms of rating physical location data and also designing and comparing alternatives is easy. Also the optimization with the brute force function is evaluated positively. Moreover, they said that they would like to use it in their daily practice.

The effectiveness of the tool as perceived by the stakeholders is good. As indicated by the [line of business] 1 representative,

'it is an excellent data driven tool to support the decision making process.'

Acceptance and trust

From the checklist at the beginning of this paragraph, it follows that each of the evaluated characteristics result in either acceptance of the system or trust in the system and its outcome. The results presented previously show that the stakeholders repeatedly confirmed their acceptance of the model and trust in the model.

A specific element that induces the user's acceptance of the model is the fact that they felt involved in the iterative development process and gained understanding of the principles of the PAS and the model. Also the fact that the model is perceived as very useful in practice and very well reflects the actual decision making process and the user's preferences, adds up to the acceptance level. This is summarized as follows by the representative of [the line of business] 1:

'The model is flexible and gives the user levers for customizing it in line with the requirements and the reality of the data points [i.e. decision variables].'

According to the evaluation results, an important role in trusting the model is played by the knowledge of the PAS principles and the backside of the model operations. Also the performance that exceeds the expectations plays a role here, especially the overlap in ranking from the PAS with the original study is deemed important.

In the final evaluation interviews, both representatives of the [advanced planning] team were asked whether or not they accepted the optimum portfolio alternative

they designed as final outcome of the ... design process and if they would use the current model in their daily practice.

Both members/ participants of the [advanced planning] team were very confident in their positive answer. Also they indicated that it would require only minor iterations on the data to actually implement the model's outcomes. Also one of them indicates that she would trust the optimum portfolio alternative found by the optimization algorithm, because she understands the model. Still a question is, however, whether or not it would be possible for her to replicate the current model code for a similar project. The evaluation of the outcomes of the brute force function, instead of the algorithm, was quite positive. Both stakeholders accepted the number 1 alternative as the best outcome of the pilot study. However, one of them indicated that she feels a little more comfortable with the number 2, since Oracle has already a small office in location 26, which is incorporated in that alternative instead of location 27. However, this does not affect the assessment of the brute force function since there is only an insignificant difference in preference between both alternatives. The other user indicated that she accepts it as the best theoretical outcome. She notes, however, that in reality this might not be the best solution since there is a current portfolio and there are no decision variables included that rate making changes in this current state. Still both stakeholders indicate that their level of trust in the system is not affected and that the optimization results strengthen their perceived usefulness of the improved PAS (De Visser, 2016, pp. 89-92).

8.3.2 The observers' evaluation

De Visser as systems engineer observed the following:

... regarding the effectiveness of PAS. During the first interviews the stakeholders neatly picked first the bottom and top reference alternative and only then established the intermediate value. It was striking however that both interviewees most of the time automatically used the variable value of the EMEA headquarters as this intermediate reference, in order to determine the respective relation with the locations with a higher or lower value. They mostly did this in such a way that it received a preference rating of >50. Because the stakeholders really relate to the values they use in establishing the preference curves, the tool is quite effective.

Another observation is that during the pilot study, people from the [line of business] were not able to dedicate a lot of time to it. This could have been due to the fact that this was a research project without direct gain for the [line of business] representative.

However, also in the original study, the [advanced planning] team had to work under a certain time pressure. This could mean that the tool is only effective when used purely by the real estate department, to generate outcomes and present these to [a line of business] in question. On the other hand however, only the first time use of the PAS with [a line of business] takes some more time, because stakeholders have to get used to the approach. Once this has happened in each global region and a broad set of decision variables, preference curves, weights and design constraints has been established, for each new case only the first four PAS steps have to be completed. Of course also location datasets have to be loaded, which should be updated once in a while. This would make it into a fairly effective tool for all stakeholders involved, in the systems engineer's perspective (De Visser, 2016, p. 91).

8.4 Pilot study comparison and conclusion

In all three pilots, the stakeholders as well as the observers evaluated the PAS very positively. The direct feedback about the effects of the chosen interventions and the possibility for iteration during the process was the other aspect that was repeatedly mentioned in each of the pilots. The group interaction or cooperation between the stakeholders was also very much appreciated in the first two pilots. In the third pilot the group dynamic was different with only two stakeholders which already had a working relation as client and supplier of space. The stakeholders indicated that they valued getting insight into their decision variables and, at the end of the studies, valued expressing their preferences with curves. In the second pilot the use of concrete decision variables was emphasized by many stakeholders. The majority of the stakeholders perceived PAS as attractive and effective. The result (goal) oriented approach contributed to the effectiveness. Almost all stakeholders expressed that they would like to continue working with PAS.

The stakeholders did not always use the same expressions in the evaluation of PAS. For instance, whereas in the first pilot the stakeholders explicitly mentioned the transparency that PAS gave, in the evaluation of the other pilots the stakeholders mentioned this implicitly. In the second pilot they indicated they liked the fact they could have insight in each other's decision variables as well as the effects, which created the transparency. While in the third pilot, the stakeholders indicated that the model performed as expected, the outcome was justified and the model complexity reflected reality, which in the pilot comparison was combined into transparency of PAS.

Most stakeholders were open-minded towards PAS from the beginning. Some of them had a more cautious stand. With all of these stakeholders we have seen that after the pilot they were (a lot more) more positive. Only one of them still questioned whether the approach (sometimes) would not be too transparent. Many stakeholders compared PAS spontaneously to other approaches and in all cases they favor PAS. The first two studies were not set up to compare PAS systematically to other approaches. However, the third pilot explicitly compared PAS favorably to their own internal process.

In the evaluations, the stakeholders also indicated improvements that could be made. The abovementioned positive aspects of PAS as well as areas of improvement have been visualized in [Figure 8.1](#).

PAS in general

For these aspects, the observers formulated one recommendation: to introduce the nature of PAS at the start of the process to the stakeholders to prevent misunderstandings about the objectivity or rationality of the approach. In essence, PAS can be labelled as a rational subjective approach.

Formulating demand (step 1 to 4)

Some stakeholders mentioned to that even more and different stakeholders could be used during the pilot study as well as variables and real estate data. Giving a simple example of assigning preferences, as has been done in the third pilot could help stakeholders at the start of the process.

Designing alternatives (step 5)

For the aspects, three recommendations were formulated. In the second pilot, the first workshop has been performed individually instead of as a group workshop. Although this helped the stakeholders understand the model and their decision variables better, the interaction of a second group workshop was missed by some. Therefore, the first recommendation is to use a combination of one individual and two group workshop for PAS and if necessary provide some stakeholders more time for the PAS process. In the consecutive pilot studies, the stakeholders have become more satisfied with the design interface(s), being most satisfied in the third pilot. The representatives of their team were specifically enthusiastic about the visual feedback and ease of use of the design interface. However, many stakeholders indicated that the interface could be improved to understand the effects of the interventions. The second recommendation is both to use less interfaces and less content per interface

and the third recommendation is to give the stakeholders the option to operate the model themselves in between the workshops, to help (some of) them to understand the backend of the model (even) better.

Choosing an optimal alternative (step 6)

For these aspects, two recommendations were made that have already been implemented successfully in the third pilot. Firstly, the use of the optimization tool (step 5b) is regarded as useful addition to the design process (step 5a). Therefore, the first recommendation is to use both ways to generate alternative real estate portfolio. Secondly, in the first two pilots, some stakeholders wanted a check on the results, because they either were not able to involve their 'constituents' or indicated that they wanted to (double) check certain aspects. In the third pilot, the stakeholders did not formulate any reservation, probably because the stakeholders repeated an existing process. This means that is stakeholders are more familiar with the pilot's subject, PAS suffices. The second recommendation therefore is to ensure sufficient time and involvement of stakeholder groups.

Summarizing, in all three pilots the stakeholders as well as the observers evaluated PAS very positively. The direct feedback about the effects of the chosen interventions and the possibility for iteration during the process was the other aspect that was repeatedly most. PAS has been tested and evaluated in three different context in two different organizations; this yields more valuable results than just applying it to one pilot. In a new pilot, it is recommended to experiment with a stakeholder operated PAS model.

From the perspective of the subject owner the evaluation showed that one of them is reserved about the desired level of transparency while the other fully supports this way of working because PAS links concrete interventions to strategic objectives. It is recommended to further study the attitude of policy makers towards a transparent approach. Next to that, it is recommended to perform a PAS process and focus only on evaluating PAS. This evaluation should be approached from both a soft and hard systems perspective from the start. Next to that, a comparative research set-up with other approaches as has been done in the third pilot could be useful.⁷⁴

⁷⁴ The improvements that stakeholders mentioned and later revoked are not mentioned in Figure 8.1.

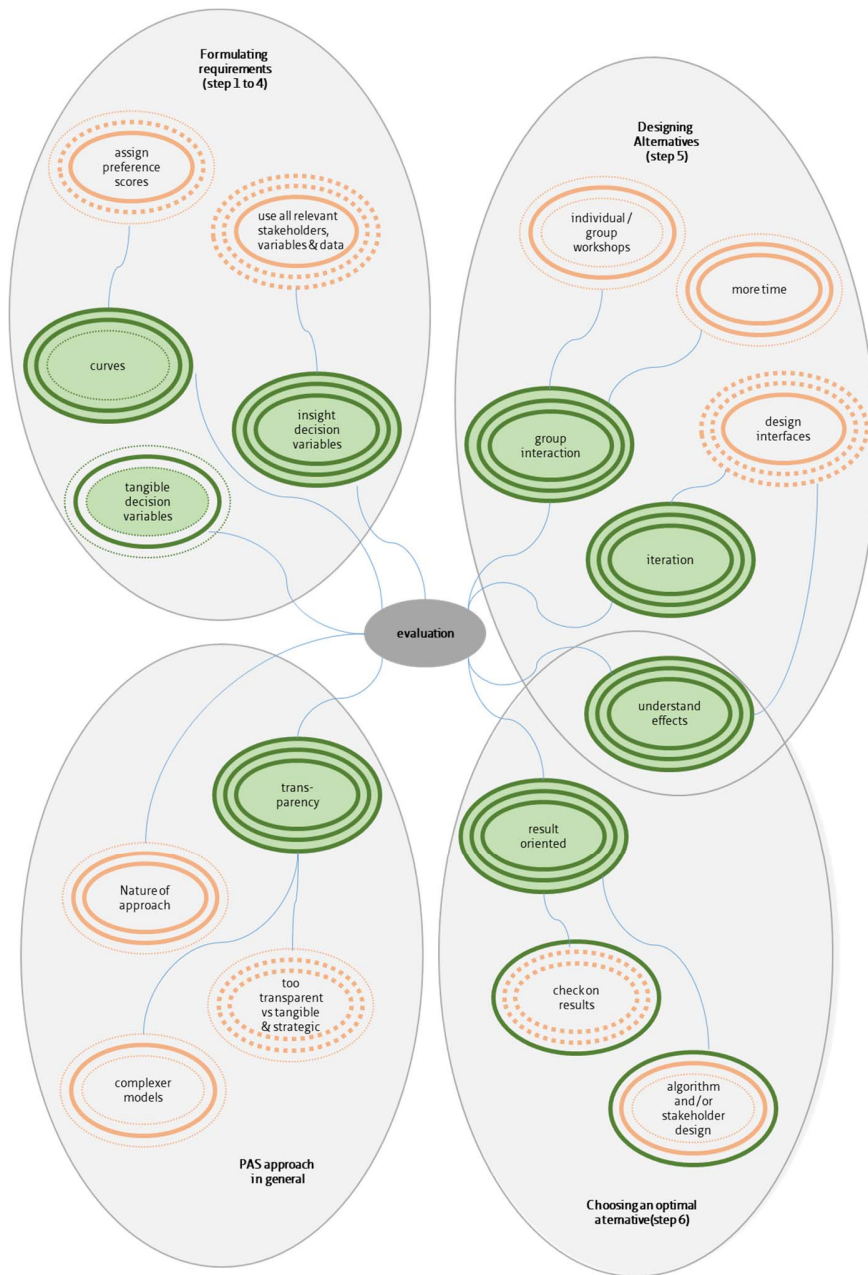

FIG. 8.1 Positive aspects and areas of improvement of PAS visualized. Legend: Each circle line represent a pilots, with the third pilot at the outer edge. A full line means an aspect was mentioned; a dotted line it was not. A green line means an aspect evaluated positively, an orange line indicates a possible improvement. The grey ovals group related aspects.

9 Reflecting upon PAS

chapter 2	CRE alignment state of the art and scientific gap
-----------	---

**Preference-based Accommodation Strategy (PAS)
design and decision approach**

Developing PAS		Testing PAS			Evaluating PAS
chapter 3	chapter 4	chapter 5	chapter 6	chapter 7	chapter 8
fifteen basic concepts and definitions from decision, design and management theory	2nd procedural rationality	steps			steps
	3rd structural rationality		stakeholders & activities		stakeholders & activities
	1st substantive rationality			model	model

chapter 9	Reflecting upon PAS
-----------	---------------------

chapter 10	Conclusions and recommendations
------------	---------------------------------

9 Reflecting upon PAS

By now, the PAS design decision method is familiar and it is known that:

- 1 The Preference-Based Design procedure could be adapted and implemented into an accommodation strategy formation project so that it can be used at real estate portfolio level in CRE alignment process (see chapter 4);
- 2 The stakeholders were able to perform all PAS design decision steps and accepted the outcome (see chapter 5 and 6);
- 3 The facilitator and the systems engineers were able to represent the pilots in mathematical decision models (see chapter 7), and;
- 4 The stakeholders evaluated PAS design decision method positively (see chapter 8).

In paragraph 9.1 it is shown that the PAS design decision method can be used as add-on to current CRE alignment management models. However, using the PAS method as add-on in these models creates managerial and methodical difficulties. The structure of these models is often not congruent with the structure of the PAS method (see chapter 2). An add-on of the PAS method in an alignment model does not fit well. To avoid these difficulties in the pilot studies a specific CRE alignment management system is set up which is congruent with the PAS design decision system: the PAS design decision management system.

The PAS design decision method has been structured from a decision making perspective around Kickert's three rationalities (components) (in De Leeuw, 2002). To complete PAS, PAS is described solely as design method in paragraph 9.2. In paragraph 9.3 the PAS management system is structured from a systems' management perspective. From this perspective the three components can be described from the organizations' point of view as well as the CRE manager and facilitator that executes PAS. Management as such is seen as steering in this thesis as is explained in chapter 3. PAS management system is defined based on a systems perspective as following the chosen basic concepts and definitions as explained in paragraph 3.1.14 and 3.1.15.

9.1 PAS as add-on to existing CRE alignment models

PAS opens the ‘black box’ of decision making in existing CRE alignment models by using a design and decision approach to CRE alignment. Initially, PAS was not intended to replace current alignment models. “It offers an approach to design alternatives and select the best design alternative and can be incorporated as an add-on in existing CRE alignment models. The existing alignment model would function as reference model to support stakeholders to determine relevant variables in line with their objectives. To support the claim that PAS can be used as add-on two examples will be given” (Arkesteijn et al., 2017, p. 260). In the first example, PAS is added to DAS frame (Den Heijer, 2011, based on de Jonge et al., 2009). PAS steps can be implemented by changing four parts of the framework (see [Figure 9.1](#)).

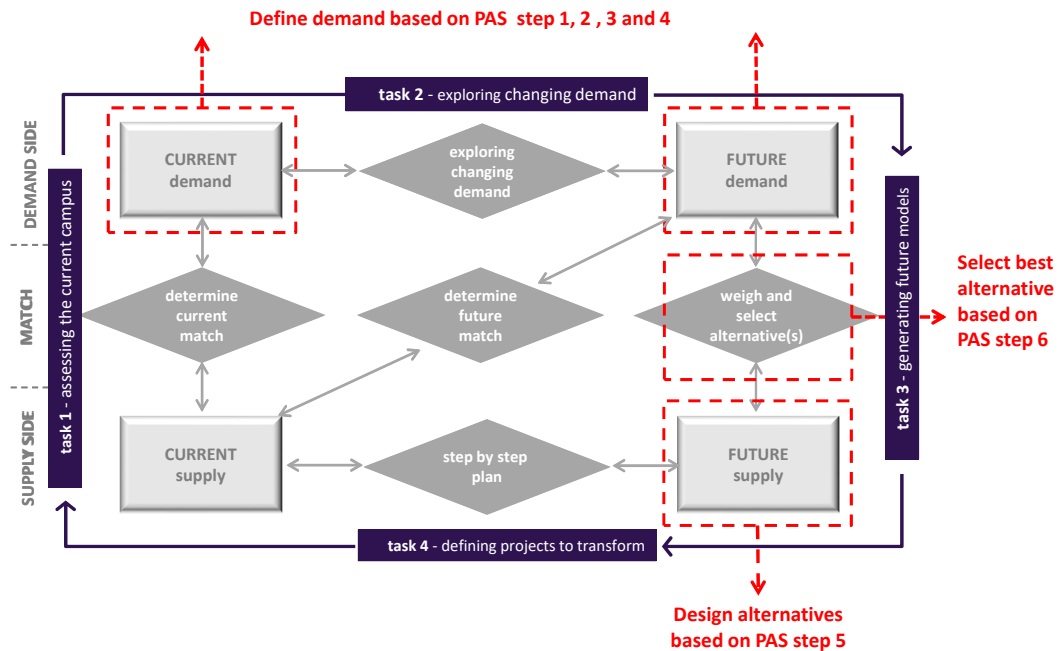

FIG. 9.1 PAS (indicated with dotted lines) implemented in DAS Note from Arkesteijn et al., 2017, p. 261 and DAS from Den Heijer, 2011, based on De Jonge et al. 2009

As a second example, ... PAS ... is added to Edwards and Ellison's alignment model [see **Figure 9.2**]. The 'organizational objectives in relation to property' can be expressed based on PAS steps 1 to 4, while the 'strategies can be formulated' based on PAS step 5 and the selection based on PAS step 6. The variables that are defined by the stakeholders to select the best option could also, in a later stage, be used to carry out the performance evaluation. Of course, during the use of a CRE portfolio, the requirements can -and probably will- change over time. PAS allows alterations in variables, preference ratings, weights as well as in constraints over time (Arkesteijn et al, 2017, p. 260).

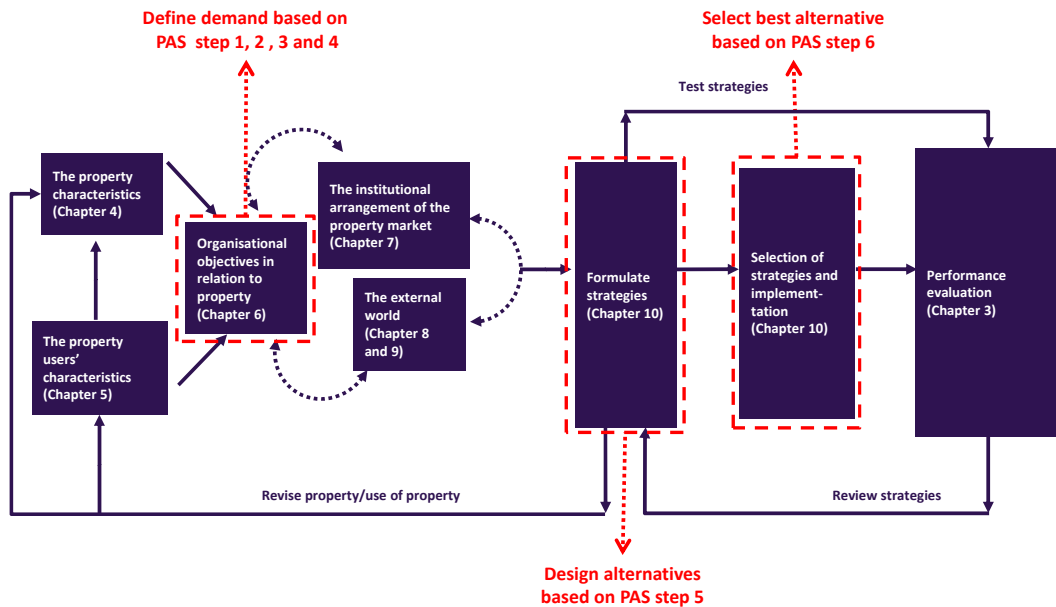

FIG. 9.2 PAS steps (indicated with black dotted lines) implemented in Alignment model (Edwards & Ellison, 2003, p. 18) © Used with permission. All rights reserved. No part of this publication may be reproduced, stored in a retrieval system, or transmitted, in any form or any means, electronic, mechanical, photocopying, recording or otherwise, except as permitted by the UK Copyright, Designs and Patents Act 1988, without prior permission of the original publisher. Note Figure from Arkesteijn et al., 2017, p. 261

What becomes apparent in these examples, is that PAS steps are used to enhance the current alignment models. In PAS as add-on, the PAS components *stakeholders & activities* and *model* are not taken into account. Furthermore, there might be too much overlap between PAS and existing models. Because existing alignment models have elements of a both substantive rationality in the so-called reference models and of the procedural rationality. It is recommended, to test the use of PAS as add-on to other models and/or to use PAS in combination with a reference model pur sang to select relevant decision variables.

9.2 PAS as design methodology

In this paragraph, PAS is presented solely as design methodology. PAS is summarized in four figures, this can be seen as a map that shows how the different parts are connected from a design point of view. In **Figure 9.3** it is explained how the variables and related aspects are set.

inter-stakeholder weight set by subject owner	stakeholders	problem analysis		step 1				step 2			step 3	resulting in
				decision variables	bottom reference alternative	top reference alternative	intermediate reference alternative	decision variable stakeholder weight	decision variable inter-stakeholder weight			
ws1	s1	objective 1	problem	with or without the use of a reference model define relevant decision variables	dv1	s1-dv1(x0, y0)	s1-dv1(x1, y1)	s1-dv1(x2,y2)	dv-sw1,1	dv-w1,1		
					dv2	s1-dv2(x0, y0)	s1-dv2(x1, y1)	s1-dv2(x2,y2)	dv-sw1,2	dv-w1,2		
					dv3	s1-dv3(x0, y0)	s1-dv3(x1, y1)	s1-dv3(x2,y2)	dv-sw1,n	dv-w1,n		
ws2	s2	objective 1	problem 1	model define relevant decision variables	dv1	s2-dv1(x0, y0)	s2-dv1(x1, y1)	s2-dv1(x2,y2)	dv-sw2,1	dv-w2,1		
					dv3	s2-dv3(x0, y0)	s2-dv3(x1, y1)	s2-dv3(x2,y2)	dv-sw2,3	dv-w2,3		
					dv4	s2-dv4(x0, y0)	s2-dv4(x1, y1)	s2-dv4(x2,y2)	dv-sw2,n	dv-w2,n		
wsn	sn	objective 1	problem 2	model define relevant decision variables	dv2	sn-dv2(x0, y0)	sn-dv2(x1, y1)	sn-dv2(x2,y2)	dv-sw3,2	dv-w3,2		
					dv4	sn-dv4(x0, y0)	sn-dv4(x1, y1)	sn-dv4(x2,y2)	dv-sw3,4	dv-w3,4		
					dv4	sn-dv4(x0, y0)	sn-dv4(x1, y1)	sn-dv4(x2,y2)	dv-sw3,n	dv-w3,n		
								n*100%	100%			

Legend

s	stakeholder	n	last number of the serie	dvs	decision variable stakeholder weight
w	weight	dv	decision variable	dvw	decision variable inter-stakeholder weight
ws	weight of stakeholder				

FIG. 9.3 Design methodology for PAS steps 1 to 3 ordered by stakeholder

In the second column all stakeholders that are involved are shown. Once it is known, who and how many stakeholders are involved, the subject owner can determine the weights between the stakeholders resulting in a total of 100%. In this table, the objectives, problems, variables, preference curves and weights are displayed. After the stakeholders have determined the weights of their decision variables, also adding up to a 100 per stakeholder, the decision variable inter-stakeholder weight can be calculated. The stakeholders can use a reference model to determine relevant decision variables for the objectives they have. By using such a reference model, they benefit from existing knowledge. However, they are free to choose which reference model to use and which decision variables they find useful for their particular situation and problem. It should be noted here as well, that the stakeholders as well as the subject owner can change any of their input during the iterative process.

That is a key element in PAS that enables them to become reflective practitioners (Schön, 1987).

As explained in chapter 3, the objective and problem are the two sides of the same 'medal'. The relationship of a stakeholder, objectives, problems and variables can be 1:1, 1:n or n:1. As, has been shown in paragraph 5.1 stakeholders can define a problem without an objective, or an objective without a problem or a decision variable without a problem and an objective. This table combines the information of a pilot study as displayed in Figures 5.6, 5.7, 5.8, 5.9, 5.10, 5.11, 5.18 and 5.20.

Once all information is known, the table can be ordered by the decision variable instead of the stakeholder (see Figure 9.4). This will allow the facilitator and the system engineer to build the mathematical model and propose relevant interventions. Each decision variable has an intervention, following the law of Asby as described in De Leeuw (2002, p. 160) "The law of the requisite variety of Ashby states that there must be at least as many different steering measures as the number of disruptions".

step 1		step 3	step 2			resulting in
decision variables	stakeholders	decision variable stakeholder weight	bottom reference alternative	top reference alternative	intermediate reference alternative	inter-stakeholder weight
dv1	s1	dv-sw1,1	s1-dv1(x0, y0)	s1-dv1(x1, y1)	s1-dv1(x2,y2)	dv-w1
	s2	dv-sw1,2	s2-dv1(x0, y0)	s2-dv1(x1, y1)	s2-dv1(x2,y2)	
dv2	s1	dv-sw2,1	s1-dv2(x0, y0)	s1-dv2(x1, y1)	s1-dv2(x2,y2)	dv-w2
	sn	dv-sw2,n	sn-dv2(x0, y0)	sn-dv2(x1, y1)	sn-dv2(x2,y2)	
dv3	s2	dv-sw3,2	s2-dv3(x0, y0)	s2-dv3(x1, y1)	s2-dv3(x2,y2)	dv-w3
dv4	sn	dv-sw4,n	sn-dv4(x0, y0)	sn-dv4(x1, y1)	sn-dv4(x2,y2)	dv-w4
dvn	s1	dv-swn,1	s1-dvn(x0, y0)	s1-dvn(x1, y1)	s1-dvn(x2,y2)	dv-wn
	s2	dv-swn,2	s2-dvn(x0, y0)	s2-dvn(x1, y1)	s2-dvn(x2,y2)	
	sn	dv-swn,n	sn-dv2(x0, y0)	sn-dvn(x1, y1)	sn-dvn(x2,y2)	
n*100%						100%

Legend (new abbreviations)

dv-sw decision variable stakeholder weight dv-w decision variable inter-stakeholder weight

FIG. 9.4 PAS steps 1 to 3 ordered by decision variables

Figure 9.4 combines the information as shown in Figure 9.3 combined with Figure 5.12 in a pilot study.

In Figure 9.5, it is shown how the decision variables, objects, interventions and states are related.

step 1	decision variables	dv1		dv2		dv3	dv4	dvn					
	stakeholders	s1	s2	s1	sn	s2	sn	s1	s2	sn			
step 3	decision variable stakeholder weight	dv-sw1,1	dv-sw1,2	dv-sw2,1	dv-sw2,n	dv-sw3,2	dv-sw4,n	dv-sw1,n	dv-sw1,2	dv-sw1,n	n*		
	bottom reference alternative	s1-dv1(x0, y0)	s2-dv1(x0, y0)	s1-dv2(x0, y0)	sn-dv2(x0, y0)	s2-dv3(x0, y0)	sn-dv4(x0, y0)	s1-dvn(x0, y0)	s2-dvn(x0, y0)	sn-dv2(x0, y0)			
step 2	top reference alternative	S1-dv1(x1, y1)	S2-dv1(x1, y1)	S1-dv2(x1, y1)	S1ndv2(x1, y1)	S2-dv3(x1, y1)	sn-dv4(x1, y1)	S1-dvn(x1, y1)	S2-dvn(x1, y1)	sn-dvn(x1, y1)			
	intermediate reference alternative	s1-dv1(x2,y2)	s2-dv1(x2,y2)	s1-dv2(x2,y2)	sn-dv2(x2,y2)	s2-dv3(x2,y2)	sn-dv4(x2,y2)	s1-dvn(x2,y2)	s2-dvn(x2,y2)	sn-dvn(x2,y2)			
resulting in	inter-stakeholder weight	dv-w1		dv-w2		dv-w3	dv-w4	dv-wn			100%		
		dv-v1,1,1		dv-v2,1,1		dv-v3,1,1	dv-v4,1,1	dv-vn,1,1					
step 5	object X1	i1,1	st1,1	ps-dv-v 1,1,1,1		ps-dv-v 1,1,1,2	ps-dv-v 2,1,1,1	ps-dv-v 2,1,1,n	ps-dv-v 3,1,1,2	ps-dv-v 4,1,1,n	ps-dv-v n,1,1,1	ps-dv-v n,1,1,2	ps-dv-v n,1,1,n
				dv-v1,1,2		dv-v2,1,2		dv-v3,1,2	dv-v4,1,2	dv-vn,1,2			
		i1,2	st1,2	ps-dv-v 1,1,2,1		ps-dv-v 1,1,2,2	ps-dv-v 2,1,2,1	ps-dv-v 2,1,2,n	ps-dv-v 3,1,2,2	ps-dv-v 4,1,2,n	ps-dv-v n,1,2,1	ps-dv-v n,1,2,2	ps-dv-v n,1,2,n
				dps-dv-v 1,1,2,1		dps-dv-v 1,1,2,2	dps-dv-v 2,1,2,2	dps-dv-v 2,1,2,n	dps-dv-v 3,1,2,3	dps-dv-v 4,1,2,n	dps-dv-v n,1,2,1	dps-dv-v n,1,2,2	dps-dv-v n,1,2,n
		i1,3	st1,3	ps-dv-v 1,1,3,1		ps-dv-v 1,1,3,2	ps-dv-v 2,1,3,2	ps-dv-v 2,1,3,2	ps-dv-v 3,1,3,2	ps-dv-v 4,1,3,2	ps-dv-v n,1,3,2	ps-dv-v n,1,3,2	ps-dv-v n,1,3,2
				dps-dv-v 1,1,3,1		dps-dv-v 1,1,3,2	dps-dv-v 2,1,3,2	dps-dv-v 2,1,3,2	dps-dv-v 3,1,3,3	dps-dv-v 4,1,3,3	dps-dv-v n,1,3,2	dps-dv-v n,1,3,2	dps-dv-v n,1,3,2
		i1,4	st1,4	ps-dv-v 1,1,4,1		ps-dv-v 1,1,4,2	ps-dv-v 2,1,4,1	ps-dv-v 2,1,4,n	ps-dv-v 3,1,4,2	ps-dv-v 4,1,4,n	ps-dv-v n,1,4,1	ps-dv-v n,1,4,2	ps-dv-v n,1,4,n
				dps-dv-v 1,1,4,1		dps-dv-v 1,1,4,2	dps-dv-v 2,1,4,2	dps-dv-v 2,1,4,n	dps-dv-v 3,1,4,3	dps-dv-v 4,1,4,n	dps-dv-v n,1,4,1	dps-dv-v n,1,4,2	dps-dv-v n,1,4,n
		i1,n	st1,n	ps-dv-v 1,1,n,1		ps-dv-v 1,1,n,2	ps-dv-v 2,1,n,1	ps-dv-v 2,1,n,n	ps-dv-v 3,1,n,2	ps-dv-v 4,1,n,n	ps-dv-v n,1,n,1	ps-dv-v n,1,n,2	ps-dv-v n,1,n,n
				dps-dv-v 1,1,n,1		dps-dv-v 1,1,n,2	dps-dv-v 2,1,n,2	dps-dv-v 2,1,n,n	dps-dv-v 3,1,n,3	dps-dv-v 4,1,n,n	dps-dv-v n,1,n,1	dps-dv-v n,1,n,2	dps-dv-v n,1,n,n

Legend (new abbreviations)

o	object	st	state	iv	invention vector	dps	delta preference score or preference rating
i	intervention	sv	state vector	ps	preference score or preference rating		

FIG. 9.5 PAS step 4 ordered by decision variables (Table with turned direction for readability; original Table added at next page to be used in digital version)

step 1		step 2				resulting	step 3													
decision variables	stakeholder	decision variable stakeholder weight	bottom reference alternative	top reference alternative	intermediate reference alternative	inter-stakeholder weight	object i1													
							i1, st1,1	i1,2, st1,2	i1,3, st1,3	i1,4, st1,4	i1,n, st1,n									
d1	s1	dr=sw1,1	i1-dv1(i0,y)	i1-dv1(i1,y)	i1-dv1(i2,y)	dr-w1	dr-v1,1,1	ps-dr-v1,1,1,1	dr-v1,1,2	ps-dr-v1,1,2,1	ps-dr-v1,1,2,2	dr-v1,1,2	ps-dr-v1,1,3,1	ps-dr-v1,1,3,2	dr-v1,1,2	ps-dr-v1,1,4,1	ps-dr-v1,1,4,2	dr-v1,1,n	ps-dr-v1,1,n,1	ps-dr-v1,1,n,2
	s2	dr=sw1,2	i2-dv1(i0,y)	i2-dv1(i1,y)	i2-dv1(i2,y)		dr-v1,1,1	ps-dr-v1,1,1,1	dr-v1,1,2	ps-dr-v1,1,2,1	ps-dr-v1,1,2,2	dr-v1,1,2	ps-dr-v1,1,3,1	ps-dr-v1,1,3,2	dr-v1,1,2	ps-dr-v1,1,4,1	ps-dr-v1,1,4,2	dr-v1,1,n	ps-dr-v1,1,n,1	ps-dr-v1,1,n,2
d2	s1	dr=sw2,1	i1-dv2(i0,y)	i1-dv2(i1,y)	i1-dv2(i2,y)	dr-w2	dr-v2,1,1	ps-dr-v2,1,1,1	dr-v2,1,2	ps-dr-v2,1,2,1	ps-dr-v2,1,2,2	dr-v2,1,2	ps-dr-v2,1,3,1	ps-dr-v2,1,3,2	dr-v2,1,2	ps-dr-v2,1,4,1	ps-dr-v2,1,4,2	dr-v2,1,n	ps-dr-v2,1,n,1	ps-dr-v2,1,n,2
	sn	dr=sw2,n	sn-dv2(i0,y)	sn-dv2(i1,y)	sn-dv2(i2,y)		dr-v2,1,1	ps-dr-v2,1,1,1	dr-v2,1,2	ps-dr-v2,1,2,1	ps-dr-v2,1,2,2	dr-v2,1,2	ps-dr-v2,1,3,1	ps-dr-v2,1,3,2	dr-v2,1,2	ps-dr-v2,1,4,1	ps-dr-v2,1,4,2	dr-v2,1,n	ps-dr-v2,1,n,1	ps-dr-v2,1,n,2
d3	s1	dr=sw3,1	i1-dv3(i0,y)	i1-dv3(i1,y)	i1-dv3(i2,y)	dr-w3	dr-v3,1,1	ps-dr-v3,1,1,1	dr-v3,1,2	ps-dr-v3,1,2,1	ps-dr-v3,1,2,2	dr-v3,1,2	ps-dr-v3,1,3,1	ps-dr-v3,1,3,2	dr-v3,1,2	ps-dr-v3,1,4,1	ps-dr-v3,1,4,2	dr-v3,1,n	ps-dr-v3,1,n,1	ps-dr-v3,1,n,2
	sn	dr=sw3,n	sn-dv3(i0,y)	sn-dv3(i1,y)	sn-dv3(i2,y)		dr-v3,1,1	ps-dr-v3,1,1,1	dr-v3,1,2	ps-dr-v3,1,2,1	ps-dr-v3,1,2,2	dr-v3,1,2	ps-dr-v3,1,3,1	ps-dr-v3,1,3,2	dr-v3,1,2	ps-dr-v3,1,4,1	ps-dr-v3,1,4,2	dr-v3,1,n	ps-dr-v3,1,n,1	ps-dr-v3,1,n,2
d4	s1	dr=sw4,1	i1-dv4(i0,y)	i1-dv4(i1,y)	i1-dv4(i2,y)	dr-w4	dr-v4,1,1	ps-dr-v4,1,1,1	dr-v4,1,2	ps-dr-v4,1,2,1	ps-dr-v4,1,2,2	dr-v4,1,2	ps-dr-v4,1,3,1	ps-dr-v4,1,3,2	dr-v4,1,2	ps-dr-v4,1,4,1	ps-dr-v4,1,4,2	dr-v4,1,n	ps-dr-v4,1,n,1	ps-dr-v4,1,n,2
	sn	dr=sw4,n	sn-dv4(i0,y)	sn-dv4(i1,y)	sn-dv4(i2,y)		dr-v4,1,1	ps-dr-v4,1,1,1	dr-v4,1,2	ps-dr-v4,1,2,1	ps-dr-v4,1,2,2	dr-v4,1,2	ps-dr-v4,1,3,1	ps-dr-v4,1,3,2	dr-v4,1,2	ps-dr-v4,1,4,1	ps-dr-v4,1,4,2	dr-v4,1,n	ps-dr-v4,1,n,1	ps-dr-v4,1,n,2
dn	s1	dr=swn,1	i1-dvsn(i0,y)	i1-dvsn(i1,y)	i1-dvsn(i2,y)	dr-wn	dr-vn,1,1	ps-dr-vn,1,1,1	dr-vn,1,2	ps-dr-vn,1,2,1	ps-dr-vn,1,2,2	dr-vn,1,2	ps-dr-vn,1,3,1	ps-dr-vn,1,3,2	dr-vn,1,2	ps-dr-vn,1,4,1	ps-dr-vn,1,4,2	dr-vn,1,n	ps-dr-vn,1,n,1	ps-dr-vn,1,n,2
	s2	dr=swn,2	i2-dvsn(i0,y)	i2-dvsn(i1,y)	i2-dvsn(i2,y)		dr-vn,1,1	ps-dr-vn,1,1,1	dr-vn,1,2	ps-dr-vn,1,2,1	ps-dr-vn,1,2,2	dr-vn,1,2	ps-dr-vn,1,3,1	ps-dr-vn,1,3,2	dr-vn,1,2	ps-dr-vn,1,4,1	ps-dr-vn,1,4,2	dr-vn,1,n	ps-dr-vn,1,n,1	ps-dr-vn,1,n,2
sn	dr=swn,n	sn-dvsn(i0,y)	sn-dvsn(i1,y)	sn-dvsn(i2,y)			ps-dr-vn,1,1,n		ps-dr-vn,1,2,n	ps-dr-vn,1,2,n		ps-dr-vn,1,3,n	ps-dr-vn,1,3,n		ps-dr-vn,1,4,n	ps-dr-vn,1,4,n		ps-dr-vn,1,n,n	ps-dr-vn,1,n,n	
		n=100%					100%													

In **Figure 9.5**, it is shown that for an object an intervention (i) leads to a new state(sv). The state vector is an alternative in the form (x_1, \dots, x_{16}) where x_j is the state of an object j as explained in paragraph 4.5.1. For this new state, the decision variable value for each of the decision variables is known and can be calculated. Subsequently based on each of the preference curves per stakeholder and decision variable, the preference rating per decision variable for each stakeholder can be calculated. If this preference rating is known, the difference (delta) between the current state (always st1) and the new state can be determined. In the figure all options (for each intervention and state) are given. However, when designing new CRE portfolios, i.e. a new alternative, each object can only have one state, i.e. only one intervention can be chosen. Next to that, in this example, it is assumed that the stakeholders for each decision variable sets a demand linked to an object, therefore each of the decision variables has a preference score per object, per intervention. The following two interventions 'doing nothing' and 'closing the object' are always available. The intervention 'doing nothing' is identical to the current state (situation or supply). If a stakeholder sets a demand for a decision variable which is linked to the total CRE portfolio, these preference scores cannot be calculated (see **Figure 9.6**).

In **Figure 9.6**, a new state is displayed. In this example it is assumed that the stakeholders set a demand for an object only for decision variable 1, while the others decision variables are assumed to be set for the total portfolio. This means that only decision variable 1 has preference scores and delta preference scores for each object. As can be seen in the example for object 1 the chosen intervention is 3 and for object n, it is n. For object 2, the chosen intervention is 1. This means 'doing nothing', therefore the delta preference score is automatically 0. The chosen interventions lead to a state vector of $(3, 1, n)$.

The calculation of the decision variable values and the preference scores depend on the type of variable and follows the formulas as explained in paragraph 4.5. Sometimes, the calculation is the average of all decision variables values. And

sometimes it is the minimum objects' decision variables values (remember the walking distance).

Figure 9.6 combines the information as shown in Figure 9.3, Figure 9.4 combined the interventions as explained in for instance paragraph 5.1.6 and 6.1.1 leading to the output as displayed in Figure 5.23 and Figure 6.6.

step 1		step 5							step 6		
decision variables	stakeholders	object X1		object X2		object Xn			portfolio of objects (X1, X2, Xn)		
		i 1,3		i 2,1		i n,n			intervention vector iv (3,1,n)		
		st1,3		s2,1		sn,n			new portfolio alternative, i.e. sv (3,1,n)		
dv1	s1	ps-dv-v 1,1,3,1	dps-dv-v 1,1,3,1	ps-dv-v 1,2,1,1	ps-dv-v 1,n,n,1	dps-dv-v 1,n,n,1	average ps-dv1-v-sv (3,1,n)	s1	dps-dv1-v-sv (3,1,n)		
	s2	ps-dv-v 1,1,3,2	dps-dv-v 1,1,3,2	ps-dv-v 1,2,1,2	ps-dv-v 1,n,n,2	dps-dv-v 1,n,n,2	minimum ps-dv1-v-sv (3,1,n)	s2	dps-dv1-v-sv (3,1,n)		
dv2	s1	n.a.	n.a.	0	n.a.	n.a.	ps-dv2-v-sv (3,1,n)	s1	dps-dv2-v-sv (3,1,n)		
	sn	n.a.	n.a.	0	n.a.	n.a.		sn	dps-dv2-v-sv (3,1,n)		
dv3	s2	n.a.	n.a.	0	n.a.	n.a.	ps-dv3-v-sv (3,1,n)	s2	dps-dv3-v-sv (3,1,n)		
dv4	sn	n.a.	n.a.	0	n.a.	n.a.	ps-dv4-v-sv (3,1,n)	sn	dps-dv4-v-sv (3,1,n)		
dvn	s1	n.a.	n.a.	0	n.a.	n.a.	ps-dvn-v-sv (3,1,n)	s1	dps-dvn-v-sv (3,1,n)		
	s2	n.a.	n.a.	0	n.a.	n.a.		s2	dps-dvn-v-sv (3,1,n)		
	sn	n.a.	n.a.	0	n.a.	n.a.		sn	dps-dvn-v-sv (3,1,n)		

Legend (new abbreviations)

ops	overall preference score or preference rating	ill	preference score per stakeholder	ops-s1-sv (3,1,n)	dops-s1-sv (3,1,n)
dops	delta overall preference score or preference rating			ops-s2-sv (3,1,n)	dops-s2-sv (3,1,n)
				ops-sn-sv (3,1,n)	dops-sn-sv (3,1,n)
			overall preference score new portfolio	ops-sv(3,1,n)	dops-sv(3,1,n)
			added value new portfolio	(ops-sv(3,1,n))-(ops-sv(1,1,1))	

FIG. 9.6 PAS step 4 a designed alternative with overall preference score ordered by decision variables

9.3 PAS design decision management system

The PAS design decision system has been extended into a design decision management system, following De Leeuw's system modeling approach (2002). With the PAS design decision management system the PAS design and decision method can be represented from the organizations' point of view.

In this paragraph first the basic model features and the overall structure of the PAS design decision and management system are elaborated. Then the four subsystems are described: the PAS set up and steer subsystem; the PAS programming subsystem; the PAS decision modeling subsystem; and the PAS design subsystem. The subsystems are each described as a management system with a steering unit, a steered unit, an environment, steering measures and information flows. In the PAS steering system the organization that will execute and steer the PAS design and decision method is established; the other three systems are all a part of the management system.

The PAS steering subsystem consists of acknowledging a CRE alignment problem and formally starting a process to solve the problem together with the involved stakeholders under guidance of a facilitator and systems engineer. The input is the real-life system of the current stakeholders, including their current knowledge of the organization and its environment. The output of the system is a preliminary problem description.

- In the PAS modeling subsystem the system engineer and facilitator build a mathematical model based on this program of requirements.
- The PAS programming subsystem is defined as the transformation of a vague problem situation into a well-defined problem. The transformation to a well described problem is done by the selected stakeholders in interviews with the facilitator. The output of the system is a program of requirements.
- In the PAS decision modeling subsystem the system engineer and facilitator build a mathematical model based on this program of requirements.
- In the PAS design subsystem the stakeholders design alternative real estate portfolios in the mathematical model to solve the problem, i.e. reach the objectives that are defined in the program of requirements.

The steering, programming, modeling, and design subsystems, and the steering measures, and information flows between them constitute the core of the PAS management system. For each subsystem the steering unit, steered system, the

steering measures and information between them are described as well as its input, output and environment .

The basic features and the structure of PAS design decision management system as a whole are presented in paragraph 9.2.1, where after each of the four subsystems of the PAS management system are discussed separately in subsequent paragraphs:

- Steering subsystem in paragraph 9.2.2;
- Programming subsystem in 9.2.3;
- Modeling subsystem in 9.2.4;
- Design subsystem in 9.2.5.

9.3.1 **Basic features and structure of PAS design decision management model**

The basic features of the representation of PAS in a management model are:

The operational goal (function)

The goal (function) of the PAS design management system is to enable stakeholders to design together a corporate real estate portfolio that adds optimal value to the organization. This management system can be seen as human activity system, in general consisting of the following human activities:

A PAS facilitator together with the CRE manager, the responsible manager and relevant internal and external stakeholders of an organization solve a strategic real estate portfolio problem. All stakeholders, as designers and decision makers, define their program of requirements based on which a systems engineer builds a mathematical decision model of the portfolio (as a set of real estate objects). All stakeholders then together design alternative corporate real estate portfolios in this model and select the alternative that adds most value to the organization. This is the portfolio with the highest overall preference score.

The actors involved in the PAS design process are:

The clients (C) are the CRE manager and the responsible manager, the actors (A) are the facilitator, system engineer, internal and external stakeholders, the transformation process (T) is the formulation of the program of requirements and the design of new real estate portfolios, taking into account the individual weltanschauung (W) of the actors. The owner (O) of the real estate often is the own

organization or if buildings are rented a real estate investors. The environment (E) often will be determined by the organization itself including a variety of users of the space. (see paragraph 3.1.15 for these CATWOE structure of actors).

The system boundaries

The PAS design management system as a human system generates strategic plans. The first boundary decision concerns the phases of a management process. The PAS design management model is limited to the diagnosis and design phase and does not include change (execution and use) phase at the end.

The second boundary is determined by the responsible manager often together CRE manager; they determine what the focus. The focus often is a particular real estate problem, for instance a type a space (lecture halls), a specific activity (lectures for large audiences). The third boundary will be jointly determined by the stakeholders. Since the PAS is a goal-oriented and as such a prescriptive and normative model where the stakeholders determine the goal, i.e. norm. They determine which aspects will be included in the model or not and thereby, interactively during a PAS process set systems boundaries.

The organizational aggregation level of the actors

The PAS design management system operates on the strategic level of an organization and operates over the total span of the organization. So the actors involved in this system are grouped according the organization's structure: departments, management, board, users, ... This defined the aggregation level of the PAS management system.

The sub systems

The PAS design management system itself is an sub-aspect-phase-system (De Leeuw, 2002, 103-104) of the overall organization system as presented in [Figure 9.7](#): it concerns the accommodation of the organization. Based on the function of the PAS design and decision management system it is divided in four subsystems: steering, programming, modeling and design subsystem.

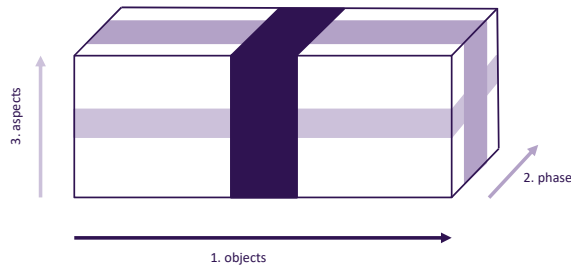

FIG. 9.7 Type of system Note adapted from De Leeuw, 2002, p. 103

Model language

The PAS design, decision and management system used three different model languages. Firstly, the PAS system is expressed in De Leeuw’s SU/SS system language where SU stands for the steering unit and SS for the steered system (De Leeuw, 2002, p. 155 as explained in paragraph 3.1.14). Secondly, the PAS system as a human activity system is expressed in root definitions using CATWOE (Clients, Actors, Transformation, Weltanschauung, Owner, Environment as shown in paragraph 3.1.15). Thirdly, the PAS management system uses the structure of problem solving and design methodology.

Based upon these features the structure of the PAS design, decision and management system is described. PAS management system consists of the following four related and nested subsystems. Subsystems of a general PAS system are production systems since they produce something:

- 1 The PAS steering subsystem for the organization of an operational PAS design management system;
- 2 The PAS programming subsystem for the generation of program of requirements for the new accommodation and the selection of an optimal design alternative;
- 3 The PAS modeling subsystem for the generation of a mathematical model for the new accommodation;
- 4 The PAS design subsystem for the generation of multiple design alternatives for the new accommodation.

The relationship between these subsystems is shown in [Figure 9.8⁷⁵](#). The subsystems are connected by arrows, where one arrow represents the steering measures from

⁷⁵ PAS as a human activity system could also have been expressed in a more loose arrow system (De Leeuw, 2002), this is not done due to PAS’s formal and normative character.

the steering unit to the steered system and the other arrow the information from the steered system to the steering unit.

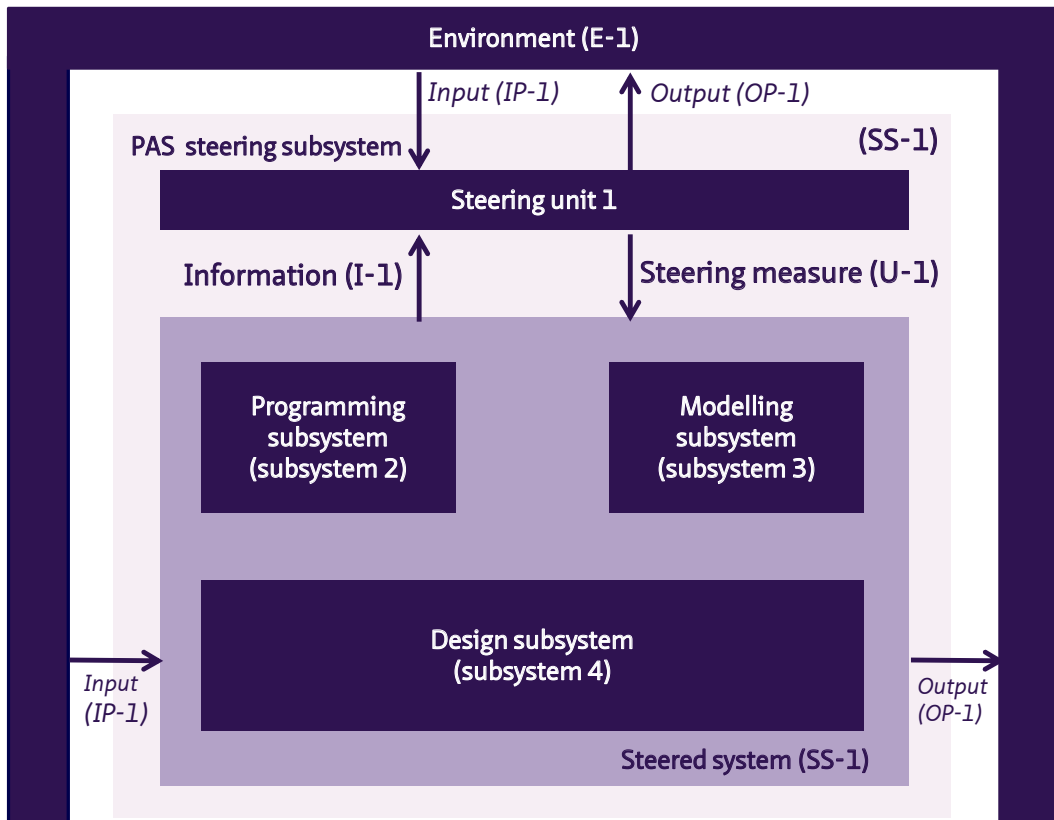

FIG. 9.8 Relationship between the four PAS management subsystems

In the PAS steering subsystem the stakeholders from the organization that will execute the PAS is determined. This group is the steering unit of this steered system. The steered system is the combination of the three other subsystems. In the second subsystem, the so-called *programming subsystem*, the stakeholders define the program of requirements. This program is the output of this subsystem and functions as the input for the third subsystem. In the third subsystem, the so-called *modeling subsystem*, a mathematical model of the situation as described in the program of requirements, is made by the systems engineer. The mathematical model is the output of subsystem 3 and functions as the input for subsystem 4. In the subsystem 4, the so-called *design subsystem*, the stakeholders design solutions in the

mathematical model that will help them solve the problem, i.e. reach the objectives that are defined in the program of requirements. The output of this subsystem is the best solution that can be designed, which is the new input for subsystem 2. In subsystem 2, the stakeholders then either approve or disapprove of this solution and if needed change their information accordingly, which will be new input for subsystem 3. The cycle between subsystems 2, 3 and 4 will be repeated until a solution is approved.

The four PAS subsystems satisfy the conditions for effective steering as defined by De Leeuw (2002, pp. 157-159). The conditions are addressed in different subsystems (see [Table 9.1](#)).

TABLE 9.1 Description conditions related to the four PAS systems

System Conditions	Steering subsystem	Programming subsystem	Modeling subsystem	Design subsystem
1. Goal function of the sub system	To generate / set up the PAS management system and determine the steering unit for the following subsystems.	To generate objectives, problems, decision variables, preference curves and weights	To calculate feasible solutions and partial as well as the overall preference score	To design feasible solutions
2. Model of steered system		Is evaluated based on the understanding of the decision variables as set in this system	Is built in this system	Is evaluated based on the results achieved in this system
3. Information about environment and state of the system		Serves as input in this system	Serves as input in this system	
4. Sufficient steering measures			Each unique design variables has an intervention (steering measure) which are defined in system 3	The steering measures are evaluated during the use of the model in the design system. The stakeholders can add interventions.
5. Capacity information processing		Can be important in this system	Is important in this system	Is important in this system

9.3.2 PAS steering subsystem

The *root definition* of the first subsystem is to set up the process organization that will execute the PAS process. The subsystem is graphically presented in [Figure 9.9](#). A PAS process starts when the CRE manager and/or the responsible manager often have acknowledged the existence of a specific CRE alignment problem. They subsequently inform the other party, and the process formally starts when the responsible CRE manager selects a facilitator to start and lead the PAS process. If the CRE manager decides to start a PAS process, the responsible manager thereby acknowledges that the subsystem is fully transparent and that the stakeholders are designers and decision makers.

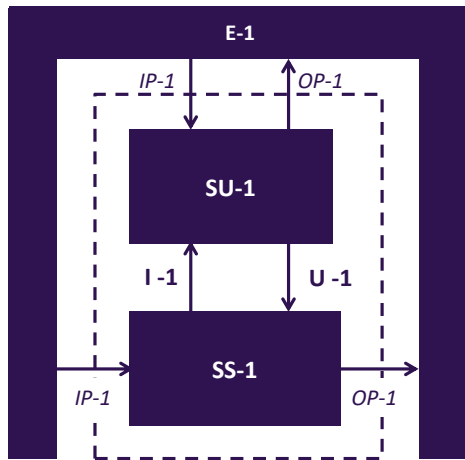

FIG. 9.9 PAS set up subsystem

The *steering unit* in this subsystem consists of the responsible manager and the PAS facilitator. They are responsible to set up a PAS process. The *steered system*⁷⁶ in the PAS set up subsystem is the process organization which consists of the relevant stakeholders. The *steering measures* from the steering unit to the steered system are the selection of stakeholders and the weights between the stakeholders. The *information* from the steered system to the steering unit is their acceptance of their role in the process and if needed a suggestion to add other relevant stakeholders. The steering unit and the steered system can consist of internal or external stakeholders which are related to the real estate problem situation. The *environment* of the system is their own organization as well as the external environment to the organization which can be relevant to the PAS process depending on the specific problem in this process. The *input* in this subsystem is the real life system of each of the selected stakeholders, including the current knowledge of their organization and it's environment as well as a the problem at hand. The *output* in this subsystem is the PAS process organization and a preliminary problem description. The steering unit of this subsystem is also the steering of the whole system.

The PAS set up subsystem is explained in [Table 9.2](#).

TABLE 9.2 Description of PAS set up subsystem

System	1	Description
Steering Unit	SU-1	Responsible manager and PAS facilitator
Steered System	SS-1	PAS organization(including the steering unit) consisting of relevant stakeholders that will execute subsystem 2, 3 and 4
Steering measures	U-1	Selection of stakeholders, the intra stakeholders (groups) weights and planning
Information	I-1	Acceptance of their role in the PAS process and possible suggestions to add other relevant stakeholders
Environment	E-1	Organization and its external environment
Input	IP-1	Real life system of each stakeholder and their current knowledge/understanding of the organization, its environment and/or the problem at hand
Output	OP-1	PAS steering unit, organization and a preliminary (vague) problem description

⁷⁶ De Leeuw (2002, p. 155) indicates that when using the SU/SS configuration one also needs to play the SU/SS game, for instance by changing the roles between the SU and the BS. By using the BU/SS game is it possible and necessary with a relative simple image of the SU/SS to capture a pluralistic view on the system, if the game is played creatively and with reason. This means that while most of the activities will be performed by the SS the SU will also perform activities. Together they will produce the output of their system.

9.3.3 PAS programming subsystem

In this section, the programming subsystem is reticulated (see [Figure 9.10](#)). The *root definition*⁷⁷ of this subsystem is to transform (T) a vague problem situation into a well described problem (De Leeuw, 2002, pp. 294-296). The transformation to a well described problem is done by the selected stakeholders (A) in a separate interview with the facilitator (A). If a stakeholder serves as a representative for a particular stakeholder group in their organization, they need to ensure that their input represents the stakeholder group (E) and that they then inform them about the (results of the) process. The programming subsystem is graphically presented in [Figure 9.11](#) and consists of multiple programming systems, one for each stakeholder. This means that there are as many 2nd subsystems as there are stakeholders in the process.

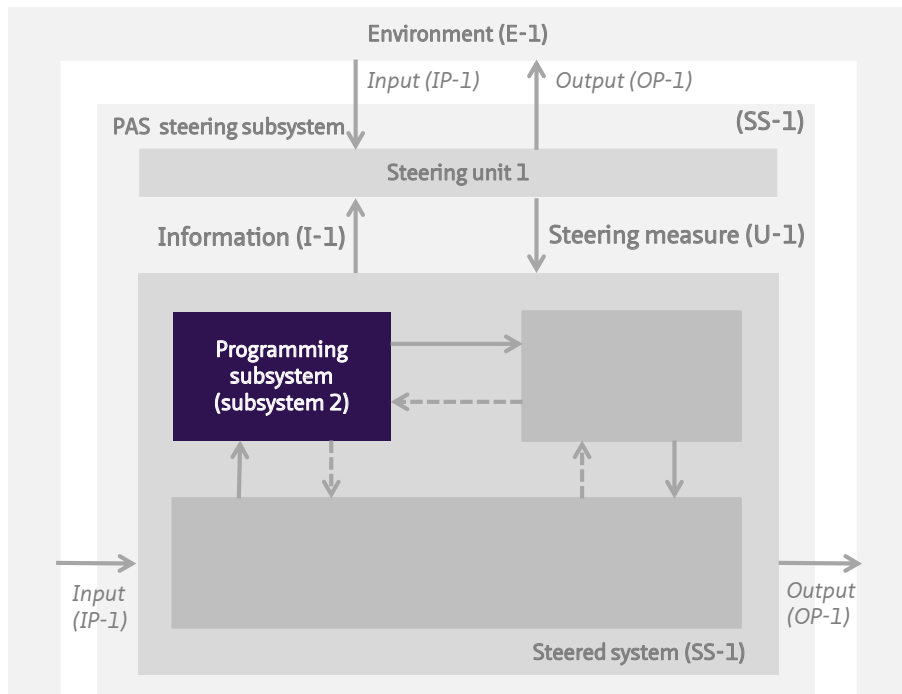

FIG. 9.10 Reticulation of programming subsystem

⁷⁷ In the root definitions of this subsystem and the following subsystems, the owners (O) and the weltanschauung (W) have not been mentioned, because this is already done in system 1.

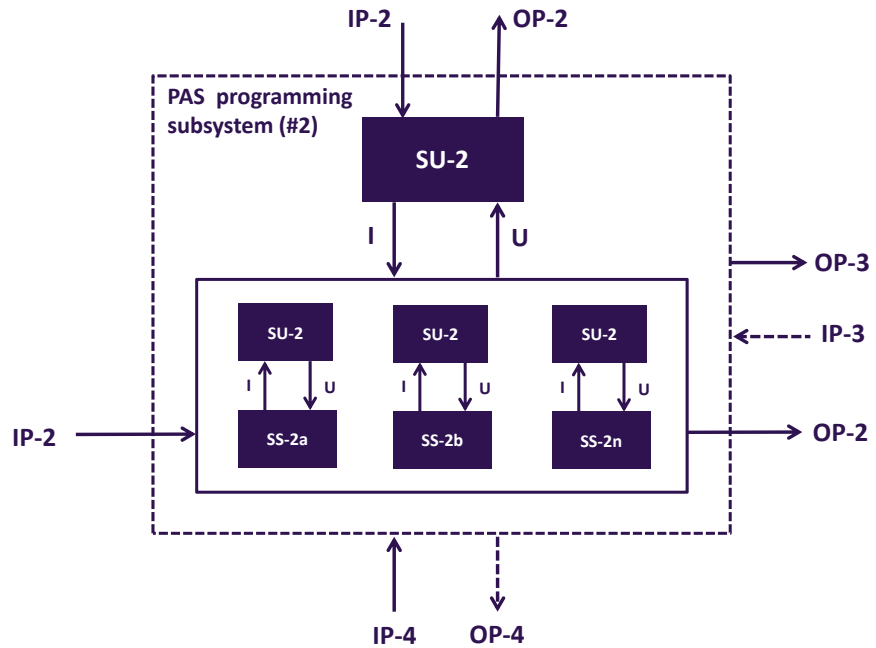

FIG. 9.11 PAS programming subsystem

The PAS programming subsystem is explained in [Table 9.3](#).

TABLE 9.3 Description of programming subsystem

System	2	Description
Steering Unit	SU-2	Facilitator (equal to the SU in subsystem 1)
Steered System	SS-2	Each stakeholder has its own version of subsystem 2 (2a, 2b to 2n)
Steering measures	U-2	Explanation of PAS, interview questions for step 1 to 4 of the PAS and a log of all approved information.
Information	I-2	Answers to interview questions as input for steps 1 to 4
Environment	E-2	Organization and its external environment (equal to E1)
Input	IP-2	Real life system of each stakeholder and the current knowledge of the organization and its environment and/or a problem at hand (equal to IP1)
		From subsystem 3: model
		From subsystem 4: the best alternative (step 5)
Output	OP-2	To subsystem 3: Result PoR (step 1 to 4)
		To subsystem 1: Approved alternative (step 6): PAS process ends

In this subsystem, the output is a program of requirements which serves as input for subsystem 3. The subsystem is iterative, as shown in the flowchart in paragraph 4.6. Part of the iteration is that the stakeholders individually approve or disapprove the design alternative that has been generated in subsystem 4. If they disapprove of the solution, they individually need to change (part of) their input for subsystem 3. The cycle between subsystem 2, 3 and 4 will be repeated until an alternative is approved by each of the stakeholders.

The steering unit is the PAS facilitator and the facilitator steers both the whole programming subsystem and is the SU in each of the steered systems. The steered system consists of all stakeholders individually, therefore multiple representations of this steered system are made, one for each stakeholder. The steering measures in this subsystem are threefold: (1) an explanation of the PAS to familiarize the stakeholders with this new approach, (2) interview questions and (3) a log of the information given, as well as the changes during the process. The information from each of the steered systems, i.e. 2a-n, to the steering unit are the answers to the questions and the approval of answers in the log. Next to that, the steered system approves the best alternative, i.e. with the highest overall preference score (output subsystem 4 the design subsystem). The input from the environment to this subsystem is equal to the input in the subsystem 1, namely the real life system of each stakeholders and the current knowledge of the organization and its environment and/or a problem at hand. All stakeholders receive the same input from subsystem 3 (the model) and subsystem 4 (the best alternative real estate portfolio). The output of this subsystem is twofold; in the earlier stages of the process it is the approved log and later on, it is the approved alternative. When all stakeholders have approved their own log, the facilitator can proceed to subsystem 3, the modeling subsystem, where the results of step 1 to 4 serve as input. Later on in the process, after subsystem 4, the design subsystem, each stakeholder separately needs to approve the best alternative in step 5. If this best alternative is approved by all stakeholders then this alternative is chosen and step 6 is executed.

The flowchart of this subsystem expressing the related stakeholders & activities, steps and models is shown in [Figure 9.12](#).

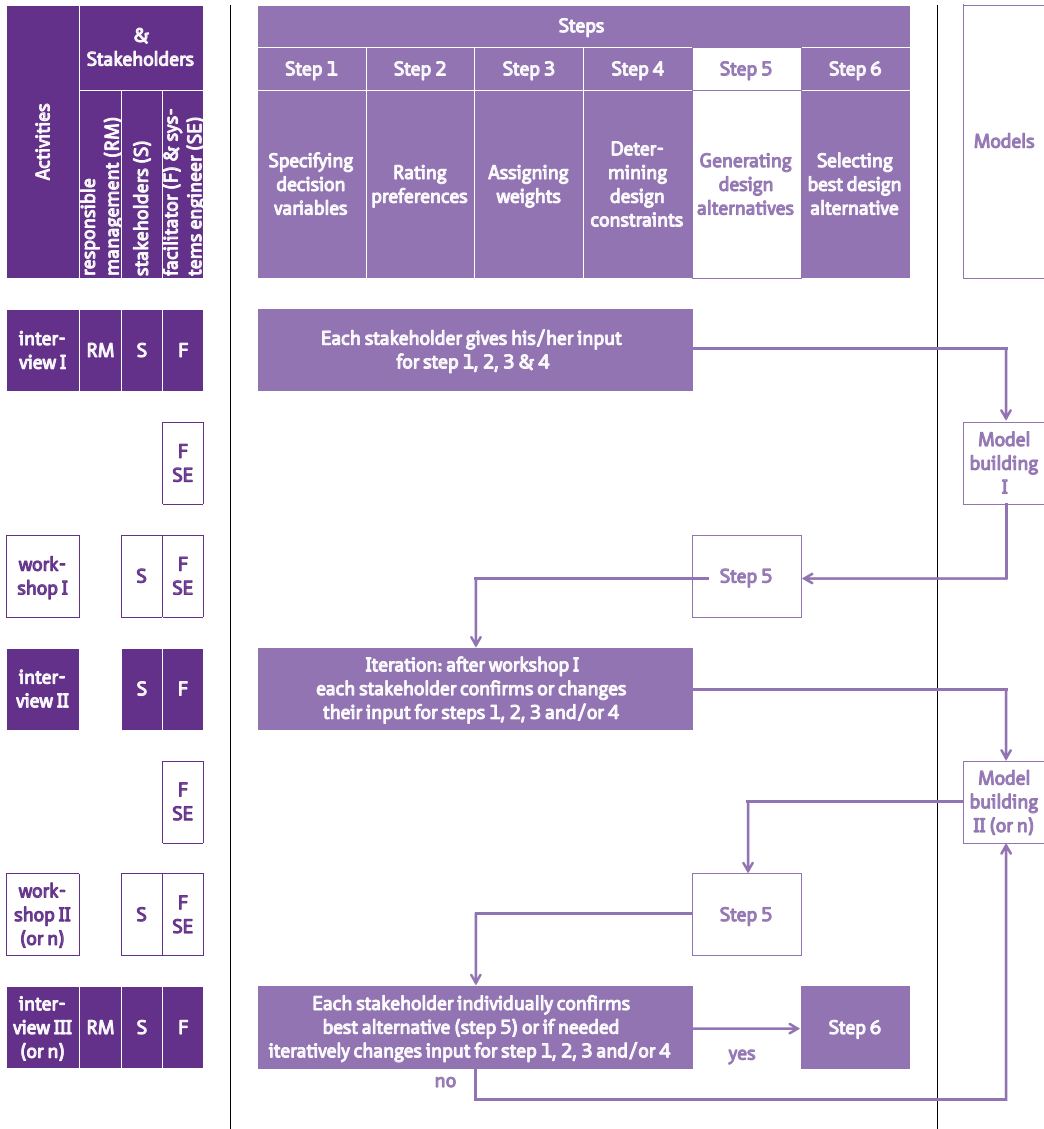

FIG. 9.12 Flowchart programming subsystem

9.3.4 PAS modeling subsystem

In this section, the modeling subsystem is reticulated (see [Figure 9.13](#)). In this subsystem, the *root definition* of the process is that the subsystem engineer (A), under guidance of the facilitator (A), builds a mathematical model (T) based on the program of requirements (as defined in subsystem 2) for the stakeholders (C), so they can use it to design alternatives (in subsystem 4). The facilitator, at any time, can approach the stakeholders (C) or other parts of the organization (E) to collect information needed to build the model. The subsystem is graphically presented in [Figure 9.14](#).

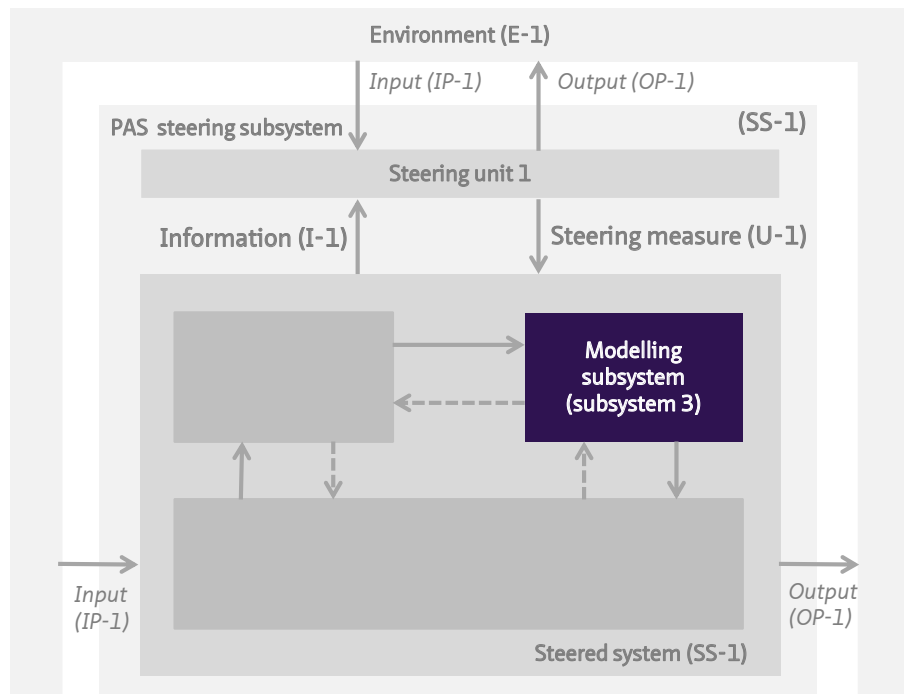

FIG. 9.13 Reticulation of modeling subsystem

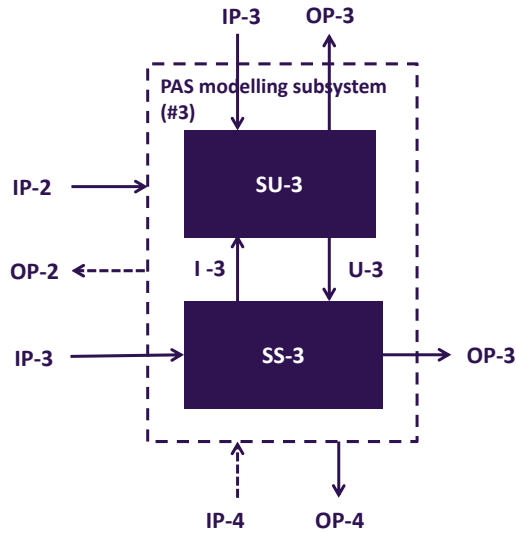

FIG. 9.14 PAS modeling subsystem

The PAS modeling subsystem is explained in [Table 9.4](#).

TABLE 9.4 Description of PAS modeling subsystem

System	3	Description
Steering Unit	SU-3	Facilitator (equal to the SU in subsystem 1 and 2)
Steered System	SS-3	System engineer
Steering measures	U-3	Interventions and relationships between the decision variables, testing and accepting of the model and if necessary clarification of input or additional information and/or data
Information	I-3	Draft model(s)
Environment	E-3	Stakeholders from subsystem 2 (equal to the SS in subsystem 2) or members for the CRE department for input about the objects.
Input	IP-3	From subsystem 2: Results of step 1 to 4 or changes results of steps 1 to 4 after using the model in subsystem 4.
		From subsystem 4: Modeling errors, i.e. misunderstandings of the relationships between the decision variables or modeling mistakes
Output	OP-3	To subsystem 2 and 4: Model (equal to input for subsystem 4) and a presentation of the model.

The steering unit is the PAS facilitator and the steered system is the system engineer(s). The steering measures in this subsystem are threefold: (1) defining the possible interventions as well as the relationships between the decision variables, (2) testing the model if it fulfills the requirements and (3) during the process provide clarification and/or additional information or data. The information from the steered system to the steering unit is twofold; (1) draft models and (2) clarifying questions. The input to this subsystem is the output of subsystem 2 and 4 (OP-2 and OP-4). After the first interview round in subsystem 2 the results of step 1 to 4 are known; the decision variables, preference curves, weights as well as the boundary conditions. After the use of the model in subsystem 4 and the subsequent interviews in subsystem 2, any of the given input is allowed to be changed. After the use of the model in subsystem 4, it is possible that modeling errors have surfaced. Errors can be either misunderstandings when defining the interventions and/or the relationships between the decision variables or modeling mistakes. The output of this subsystem is the mathematical model, which is the input for subsystem 4, the design subsystem. The model can also be given to the different stakeholders to use the model themselves, outside the workshop in order to increase the acceptance of the system.

The flowchart of this subsystem expressing the related stakeholders & activities, steps and models is shown in [Figure 9.15](#).

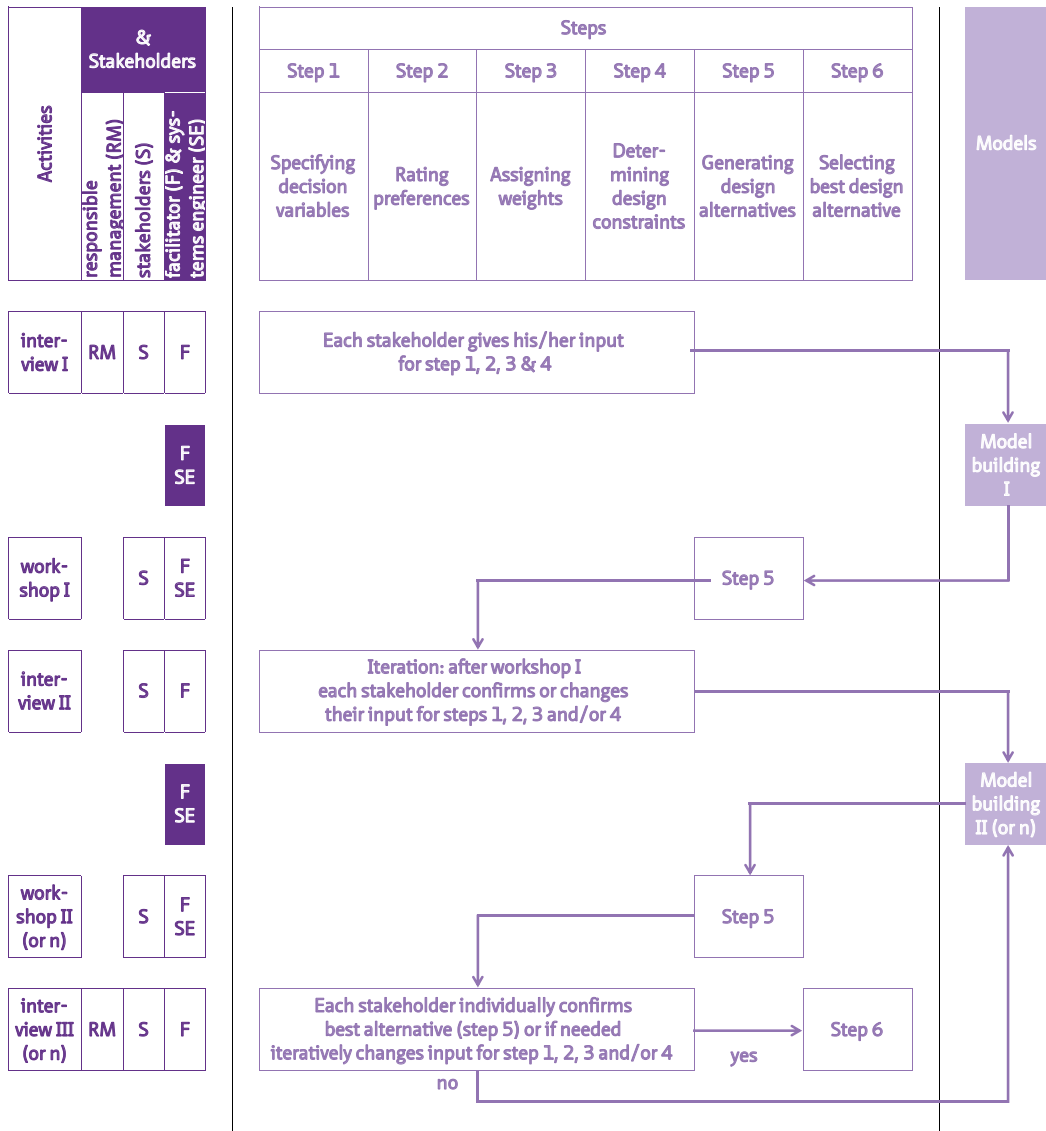

FIG. 9.15 Flowchart modeling subsystem

9.3.5 PAS design subsystem

In this section, the design subsystem is reticulated (see [Figure 9.16](#)). The *root definition* of the design subsystem is that the stakeholders (A & C), in a series of workshops under guidance of the facilitator (A), design alternative corporate real estate portfolios (T) in the mathematical model (output from subsystem 3) to achieve the objectives that are defined in the program of requirements (from subsystem 2) optimally, and therefore add most value to the responsible manager of the organization (C). If a stakeholder serves as a representative for a particular stakeholder group in their organization, they need to ensure that their input represents the stakeholder group and that they inform them (E) about the (results of the) process. The output of the this subsystem is the best alternative CRE portfolio, which is then input for subsystem 2.

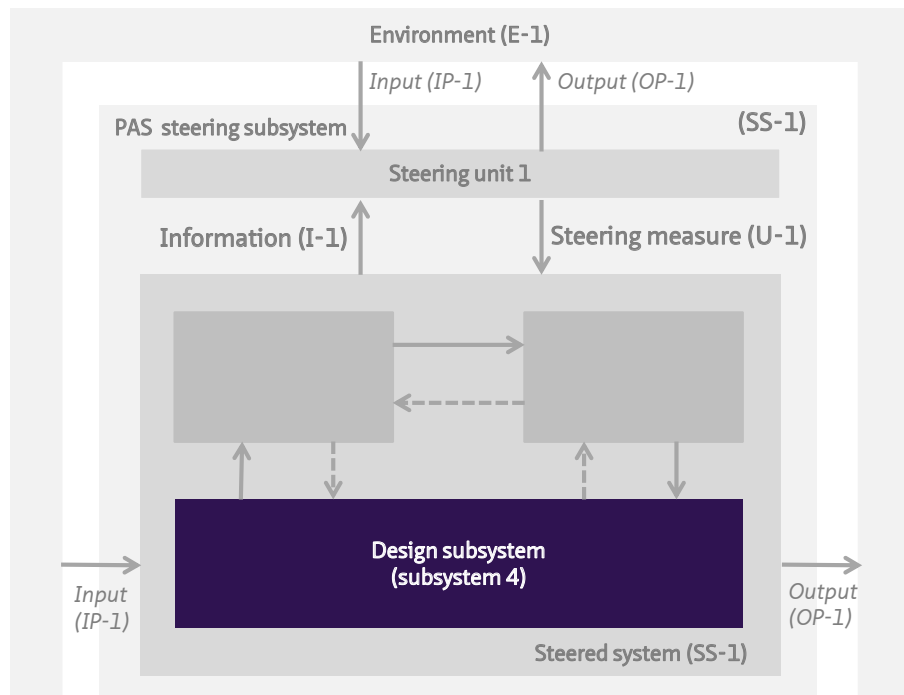

FIG. 9.16 Reticulation of design subsystem

The design subsystem is graphically presented in [Figure 9.17](#).

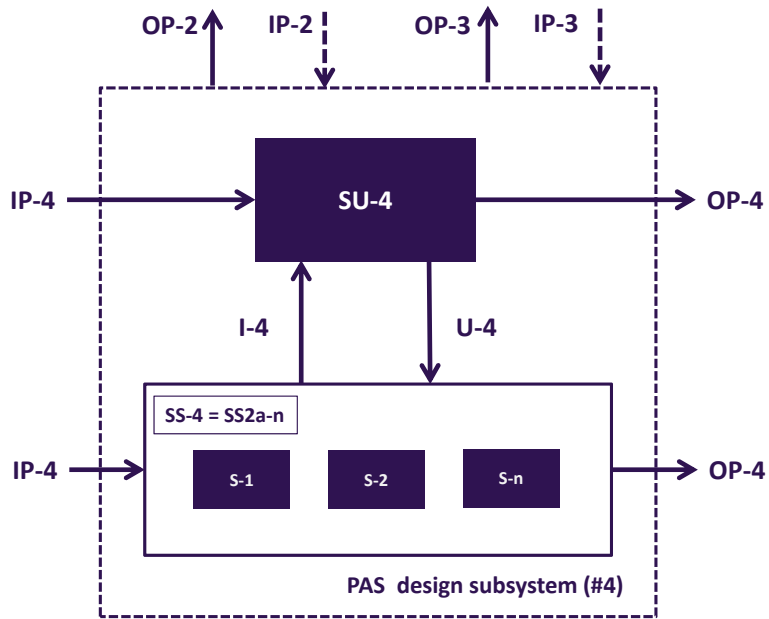

FIG. 9.17 PAS design subsystem

The PAS design subsystem is explained in [Table 9.5](#).

TABLE 9.5 Description of design subsystem

System	4	Description
Steering Unit	SU-4	Facilitator (equal to the SU in subsystem 1, 2 and 3) (and the system engineer (SS in the 3 rd subsystem)
Steered System	SS-4	All stakeholders in the pilot study (equal to the SS in the 2 nd subsystem)
Steering measures	U-4	Instructions on the working of the model, including the possible interventions for the objects and the back end of the model
Information	I-4	Generated alternative real estate portfolios
Environment	E-4	Organization and especially the groups that the stakeholders represent as well as the organization's external environment
Input	IP-4	From subsystem 2: program of requirements and an updated log From subsystem 3: the mathematical model From subsystem 3: i.e. the overall preference score of the current real estate portfolio based on their requirements
Output	Op-4	To subsystem 2: best alternative real estate portfolio that was generated To subsystem 3: possible modeling errors

The steering unit of this subsystem is the facilitator in combination with the system engineer. The steered system consists of all stakeholders as a group. The stakeholders design alternatives in the mathematical model under guidance by the system engineer and facilitator. The steering measures in this subsystem are the instructions about the mathematical model, including the interventions that are available in the mathematical model and their subsequent effects. The information from the steered system to steering unit are the designed alternatives. The input from the environment to this subsystem is equal to the input in subsystem 1, namely the real life system of each stakeholders and their current knowledge of the organization and its environment and/or a problem at hand. All stakeholders take their own input from subsystem 2 to subsystem 4 and have the same input from subsystem 3 about the model available. The output of this subsystem is twofold; in the earlier stages of the process stakeholders can detect modeling errors (to subsystem 3) and the best alternative real estate portfolio (to subsystem 2).

The flowchart of this subsystem expressing the related stakeholders & activities, steps and models is shown in [Figure 9.18](#).

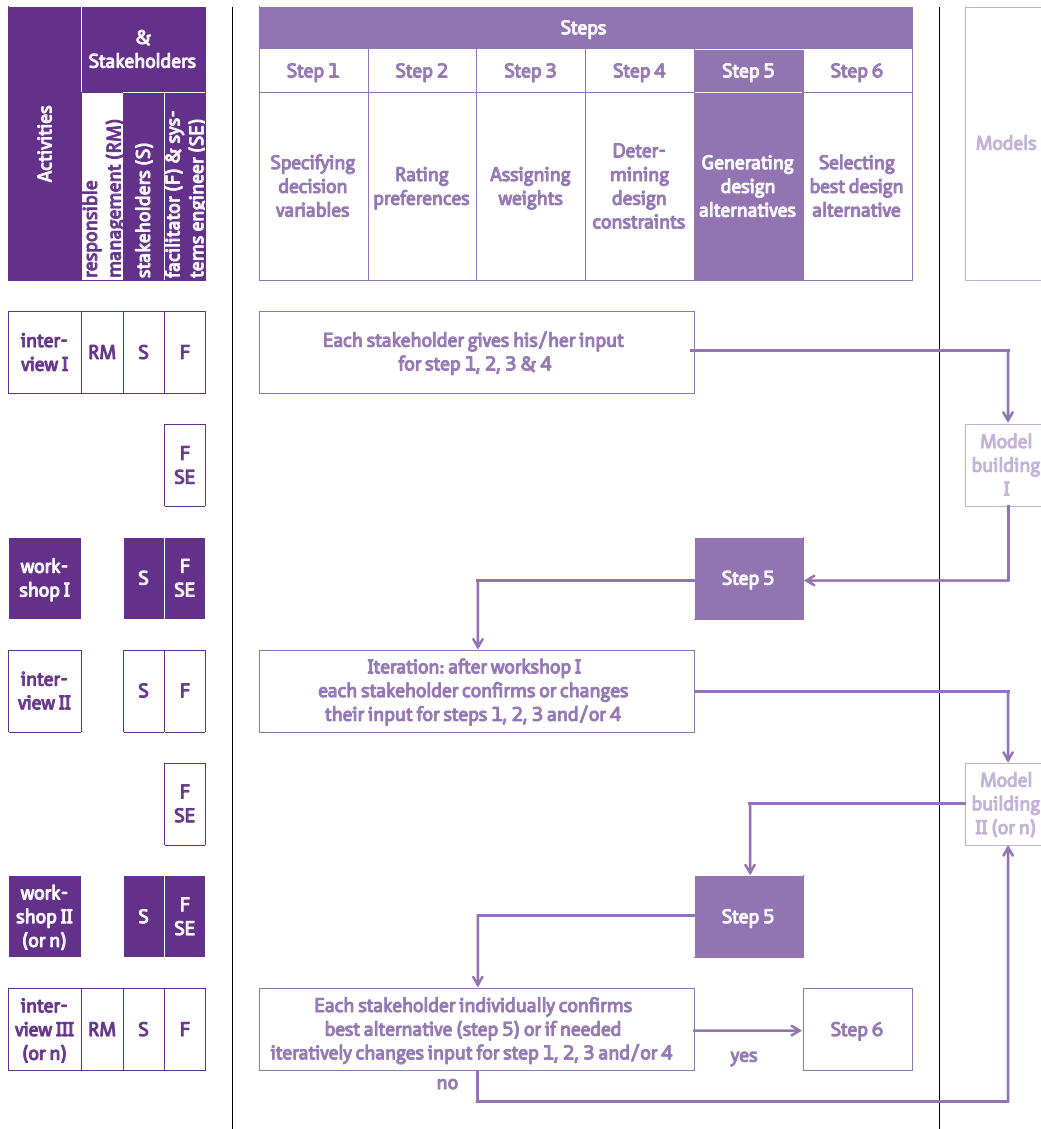

FIG. 9.18 Flowchart design subsystem

9.4 Conclusion

PAS has initially been intended to be add-on to other CRE alignment models. Two examples have been shown to demonstrate that this is feasible for the PAS steps. However, using the PAS method as add-on in these models creates managerial and methodical difficulties if PAS components *stakeholders & activities* and *model* also need to be taken into account. The structure of these models is often not congruent with the structure of the PAS method.

Therefore, PAS has been transformed into a management system, following De Leeuw (2002). A PAS management system is valuable because it represents PAS from the organizations' point of view. This management system consists of four systems: PAS steering system; PAS programming system; PAS modeling system; and PAS design system.

In the PAS steering system the organization that will execute the PAS is determined while the other three systems are all a part of the steered system. The PAS Set up system consists of acknowledging a CRE alignment problem and formally starting a process to solve the problem together with the involved stakeholders under guidance of a facilitator and systems engineer. The input is the real-life system of the current stakeholders, including their current knowledge of the organization and its environment. The output of the system is a preliminary problem description. The PAS Programming system is defined as the transformation of a vague problem situation into a well-defined problem. The transformation to a well described problem is done by the selected stakeholders in interviews with the facilitator. The output of the system is a program of requirements. In the PAS Modeling system the system engineer and facilitator build a mathematical model based on this program of requirements. In the PAS Design system the stakeholders design alternative real estate portfolios in the mathematical model to solve the problem, i.e. reach the objectives that are defined in the program of requirements. The programming, modeling and design system as well as the steering measures and information flows between them is the core of the system. For each system the steering unit, steered system, the steering measures and information between them is described as well as its input, output and environment. All four systems are congruent.

PAS has also been described from a design methodology point of view to show how all parts of the system are connected. PAS is displayed in four figures that function as a map and shows how the different parts are connected.

10 Conclusions and recommendations

chapter 2	CRE alignment state of the art and scientific gap
-----------	---

**Preference-based Accommodation Strategy (PAS)
design and decision approach**

Developing PAS		Testing PAS			Evaluating PAS
chapter 3	chapter 4	chapter 5	chapter 6	chapter 7	chapter 8
fifteen basic concepts and definitions from decision, design and management theory	2nd procedural rationality	steps			steps
	3rd structural rationality		stakeholders & activities		stakeholders & activities
	1st substantive rationality			model	model

chapter 9	Reflecting upon PAS
-----------	---------------------

chapter 10	Conclusions and recommendations
------------	---------------------------------

10 Conclusions and recommendations

Even though extensive research into existing CRE alignment models has provided us with valuable insights into the building blocks, components and variables that are needed in the alignment process, these models still fall short in two ways. Most models pay little to no attention to (1) the design of new CRE portfolios and (2) the selection of a new CRE portfolio that adds the most value to the organization. With the development of a new approach, the Preference-based Accommodation Strategy design and decision approach (PAS), I address the deficiencies of the previous alignment models that either place too much emphasis on financial measures or lack clarity in decision making due to the difficulties of quantifying the intangible and subjective. In this chapter the main research question will be answered and recommendations for further research are formulated.

How can the Preference-based Accommodation Strategy design and decision approach (PAS) successfully be developed and tested on corporate real estate portfolio level in order to enhance CRE alignment?

10.1 Conclusions

This research developed a new design and decision approach in CRE alignment that makes it possible to design alternative CRE portfolios and then select the portfolio that adds most value to the organization. This new approach called PAS is tested successfully in three pilot studies and evaluated positively by the participants. To address the successfulness of the development and the usage of PAS to enhance CRE alignment on portfolio level, the conclusions are divided into conclusions about (1) developing PAS, (2) testing PAS, (3) evaluating PAS and (4) reflecting upon PAS.

Conclusions about developing PAS

The methodological aspects, characteristics and features of PAS are based upon fifteen basic concepts and definitions coming from management science, decision theory and design methodology. Of these fifteen concepts, Preference Measurement and Preference-Based Design are the two most important ones. PAS is also structured around three rationalities (Kickert, in De Leeuw, 2002) that allow stakeholders to choose an alternative and to involve more than one decision maker and that accounts for time. For PAS to be operational, all components need to be connected coherently. The coherence between the components is shown in the flowchart (see [Figure 10.1](#)).

Following the flowchart, it is explained which activity is performed by whom and which steps are done in that particular activity. Following the arrows in the flowchart it shows how the information of one step is input for the next step. The flowchart stops in the last interview when each stakeholder individually accepts the alternative with the highest overall preference score as the selected alternative. If one of the stakeholders does not accept this alternative, this means that (part of) their input does not reflect their preferences correctly and needs to be adapted accordingly. The adapted input goes back to model building (n) and continues in the flowchart represented until all stakeholders accept the best alternative.

PAS enables stakeholders to select an alternative indisputable and correct⁷⁸

In CRE alignment, the goal is to achieve an optimal added value. Value, in this thesis, is technically equivalent to preference and is expressed in an overall preference score. PAS is *indisputable* by having one overall preference score and *correct* by using Barzilai's strong scales and the practical methodology preference functional modeling. The overall preference score of PFM is able to incorporate all types of values: both financial and non-financial, tangible and intangible, quantitative or qualitative. In mathematics, these value categorizations are not necessary to enable addition and multiplication. Barzilai (2010) distinguishes only physical or non-physical properties of an object. Following Barzilai, all physical properties are translated into non-physical properties (i.e. preference), including the preference for receiving and spending money, and aggregated into one overall preference score. By doing so, the restrictions as formulated by Barzilai (2015) and Mouter (2012) are avoided.

⁷⁸ The eight requirements are referred to using the labels as explained in chapter 2 and shown in italic in this chapter.

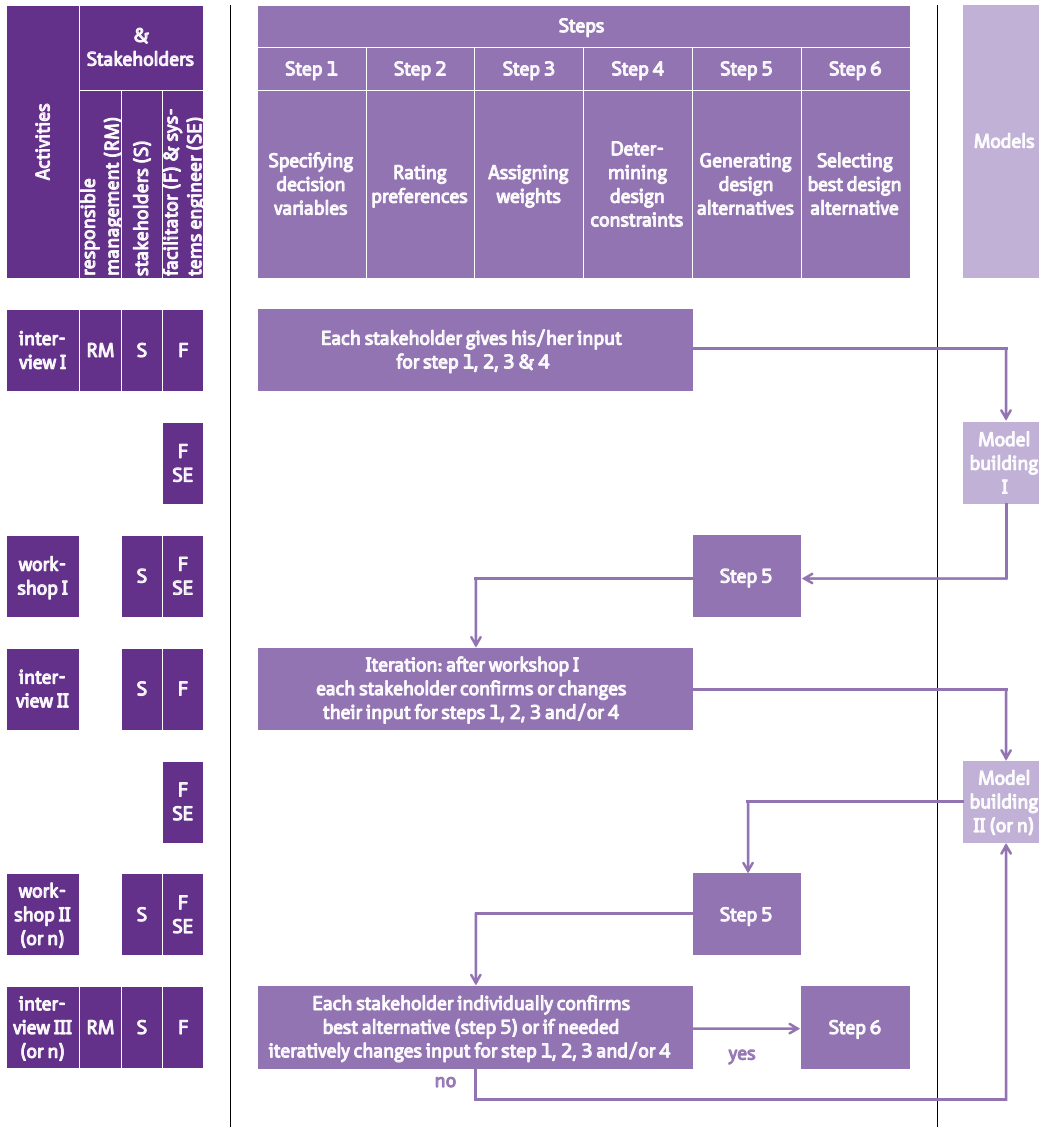

FIG. 10.1 PAS Flowchart Note adapted from Arkesteijn et al. 2017, p. 248. The stakeholders & two activities, interviews and workshops are displayed in the first four columns (darkest purple), the six steps are given in the intermediate columns (intermediate purple) while the model building is presented in the last column (lightest purple).

In PAS, the bounded rationality (Simon, 1997) concept is used; human decision makers are not perfectly informed and also have a limited capacity for information processing. They are looking a satisficing alternative instead of an optimizing alternative. The satisficing alternative is made in step 5a, while at the same time the hard goal oriented systems approach is used in parallel to find a (local or global) optimal alternative in step 5b.

PAS enables stakeholders to design alternatives interactively, iteratively and optimally

By seeing a designed accommodation strategy (generated by PAS) as a solution for an organization 's strategic accommodation problem, PAS functions as a problem solving system. Design as problem solving leads to an instrumental view on the management because next to understanding reality, people also intervene in that reality. PAS is structured around the Preference-Based Design method to solve this accommodation design problem. In order to function on portfolio level, most of the steps of this method have been altered. The most important changes have been made to step 2, where the preference curves are made a posteriori using the Lagrange curve, and to step 5. In step 5a the stakeholders design alternative CRE portfolios themselves in the mathematical model and thereby produce a satisficing alternative. The approach is *iterative* by having an *interactive* interplay between demand (step 1 to 4 in the interviews) and supply (step 5 in the workshops). PAS is also able to determine the CRE portfolio with *optimal* added value because in step 5b the system engineer uses an optimization tool for another alternative with potentially a higher overall preference score. Depending on the complexity of the pilot the optimization tool is able to find a local or global optimum.

PAS enables stakeholders to formulate their demand personally, integrally and tangibly

PAS uses a soft systems approach to enable the stakeholders to determine which goal(s) need to be achieved. The stakeholders are seen both as individual and as group as designers and decision makers. PAS is *integral* because all relevant stakeholders can be involved and are able to specify all types of requirements (qualitative and quantitative). The approach is explicit because their CRE accommodation strategy is stated in objectives and/or related problems and expressed in well-defined *tangible* decision variables. The approach is also *personal* because each criterion is established by a specific stakeholder and is linked to this stakeholder during the whole process.

Conclusions about testing PAS

PAS is tested successfully in three pilot studies. All pilot studies show that the stakeholders were able to perform the steps and activities and that the systems engineers were able to build mathematical models.

Steps to achieve CRE alignment

In all pilot studies the stakeholders were able to perform each step of PAS. While stakeholders in general are familiar with most steps, step 2 (determining preferences) and step 5 (design alternatives) are new to them. The stakeholders were able to determine their preferences and to design an alternative CRE portfolio with a higher overall preference than in the current situation (step 5a). The pilots respectively have an added value, expressed in an overall preference score of 54, 17 and 5 (see [Table 5.12](#)). In step 6, all stakeholders accepted that alternative as the final outcome.

TABLE 10.1 Achieved added value of the best design alternative (step 5a and 5b) in all pilots

Results (based on PFM algorithm)	1 st pilot study food facilities TU Delft	2 nd pilot study lecture halls TU Delft	3 rd pilot study office locations Oracle
Overall preference score current portfolio	41	53	61
Overall preference score design alternative	95 (step 5a)	70 (step 5a)	66 (step 5b)
Added value	54	17	5

In two pilot studies, an alternative CRE portfolio has been generated with an optimization tool (step 5b). In the third pilot office locations, the optimization tool was successful and generated a global optimum. This design alternative (step 5b), has an overall preference score of 66 that is higher than the overall preference score of 64 decision makers designed (step 5a) or the 61 overall preference score of the current situation.

Mathematical models to achieve CRE alignment

Due to the nature of the third pilot, the brute force approach, as optimization tool, could be used and successfully generated a global optimum (see [Table 10.1](#)). In the first pilot for the TU Delft food facilities, the algorithm (step 5b) was not able to generate a local optimum with a higher overall preference than the best alternative the decision makers designed (step 5a). The reason for this was that a subset of the alternatives was infeasible. The feasible set of alternatives could not be characterized

mathematically and was not available to the algorithm. The feasible alternative made by the group decision makers is the best alternative. The brute force approach is preferable to the search algorithm as it finds a global optimum instead of a local optimum. However, if a pilot is more complex, the brute force approach cannot produce all possible alternatives.

Sometimes, a problem can be of such complexity that it is impossible to design alternatives solely based on PAS. This was the case in the second pilot, where linear programming (LP) was needed in addition to PAS to make a timetable based on the educational demands for a certain amount of lecture halls, and to incorporate time constraints per activity. The LP timetable model is subject to the same limitations as LP with negotiable constraints. However, in this pilot progress has been made as well, because the decision makers are now better equipped with LP and PAS to design an alternative with a higher overall preference score within the timetable design space.

Stakeholders & activities to achieve CRE alignment

The stakeholders in all three pilots have successfully performed the two activities: workshops and interviews iteratively and interactively. In these activities, all six steps have been performed.

Iteration is the key: at the outset of the project, our expectation was that design alternatives themselves would help the participants to better understand the relationship between the design alternatives and their decision variables. This was confirmed in the evaluation: the participants indicated that whilst the method of determining preferences is easy, accurately determining which preference is related to a certain decision variable value is not. Assigning preference scores to decision variable values can be arbitrary at first. By repeating the cycle of determining preferences and making designs a number of times, the stakeholders can see what the effect of the decisions made in the design is, and how their preferences affect those decisions. In all pilot studies, the decision makers used the opportunity to either add or remove decision variables, change curves, weights or constraints. This means they used the opportunity to alter, add or fine tune their input and design a favorable output. This demonstrates that the feedback helps the stakeholders to better understand their input and to improve it if necessary. By doing so, the representation of their preferences in the model better depicts the actual situation. The use of such a learning process in the context of work practice and problem-solving is described by Schön (1987) as reflection in action.

The amount of the available **design interfaces** per pilot differed, as well as the intensity in which the design interfaces were used. In all pilots, the most used interface was the main interface in which alternatives could be designed, followed by the interface displaying the interventions (if available). The interface with the information per stakeholder and per criterion was used less and mainly by the system engineer. The main design interfaces for the pilots differed. While they were more visual and similar in the first and second pilots, the model for the third pilot contained more information but was less visual. In general, the conclusion is that the design interfaces with a more condensed display of information were most used.

Conclusions about evaluating PAS

In all three pilots, the stakeholders as well as the observers evaluated PAS very positively. According to the stakeholders, determining preferences and refining and adjusting them in collective workshops is the attractive part of PAS. They repeatedly mentioned the direct feedback about the effects of the chosen interventions and the possibility for iteration during the process when asked about their experience. The group interaction or cooperation between the stakeholders was also highly appreciated in the first two pilots. In the third pilot, the group dynamic was different because in the pilot only two stakeholders were involved. The reason for this was that they had just finished their own process. The stakeholders indicated that they valued getting insight into their decision variables, and at the end of the studies valued expressing their preferences with curves. In the second pilot, the use of concrete decision variables was emphasized by many stakeholders. The majority of the stakeholders perceived PAS as attractive and effective. The result (goal) oriented approach contributed to the effectiveness. Almost all stakeholders expressed that they would like a continuation of working according to PAS.

Most stakeholders were open-minded towards PAS from the beginning. Some of them had a more cautious stand; all of them were (much) more positive at the end of the pilot. Only one of them still questioned whether the approach (sometimes) would not be too transparent. Many stakeholders compared PAS spontaneously to other approaches and, in all cases, they favored PAS, even though the first two studies were not set up to systematically compare PAS to other approaches. In the third pilot, a systematic comparison has been made where PAS favorably compared to their own process.

Conclusions about reflecting upon PAS

PAS has initially been intended to complement other CRE alignment models. However, using the PAS method as an add-on in these models creates managerial and methodical difficulties. The structure of these models is often not congruent with the structure of the PAS method. Therefore, PAS has been transformed into a management system that represents PAS from the organizations' point of view. This management system consists of four systems: PAS steering system; PAS programming system; PAS modeling system; and PAS design system.

The three pilot studies show that PAS can be applied in different organizations, and for different types of problems with a different level of complexity. In comparison, the first two pilots were more complex because more stakeholders were involved and more interventions were possible. Applying this approach to multiple context-dependent cases has yielded more valuable results than just applying it to one case. It can be argued, based on these results, that PAS can be used for a wide range of real estate portfolio types.

10.2 Recommendations

The recommendations regarding this research are divided in two main areas: (1) improving PAS and (2) professionalizing PAS for practice.

10.2.1 Improving PAS

In this paragraph six different ways are explored to improve PAS.

Use PAS in different type of real life pilots and with more stakeholders

PAS is generic by nature and can be used for a wide range of problems in real estate portfolios. The more important the preferences of users are for the use of the portfolio, the more relevant a method like PAS becomes. Testing PAS in a wider variety of pilots is recommended.

In the pilot study, relevant stakeholders were represented by one or two persons. Only some groups, like the student council and the faculty secretary involved their constituents. In the evaluation the stakeholders recommended to involve more people in the process with a more diverse background. Next to involving internal stakeholders, it is recommended to involve the constituents of all groups and external stakeholders in the future.

Use PAS as part of the actual decision making

The next step in the development of PAS is to use PAS as part an actual decision making. In this thesis, PAS has been used for real life problems in a pilot situation. This means that the results were accepted by the stakeholders and used as input to the decision making process, but were not seen as the actual decision. It is recommended to test if using PAS in actual decision making gives other results or insights.

Continue the development of the search algorithm to generate alternatives

The use of an optimization tool in PAS makes it possible to achieve a (local or global) optimum alternative that stakeholders might not be able to design. It is recommended to continue developing the search algorithm, since in the first pilot it was not successful. The focus of future research should be to develop a functioning algorithm in which the infeasibilities can be incorporated and then to study the difference in quality of the solution found by the algorithm and the stakeholders.

Use PAS in transparent decision making

The subject owners of the PAS process had a different stand towards the level of transparency in PAS. Where one was reserved about amount of transparency, the other fully supported this way of working. One of the stakeholders indicated that PAS has gradually taken him into the process to find an optimal solution. However, this participant, while satisfied with the result, does not rule out that he would have played strategic games when confronted with a less positive result.

PAS is transparent and thus a glass box and non-manipulative, as the facilitator and system engineer refrains from incorporating their own personal preferences. An organization that wants to use PAS consciously needs to choose such a transparent approach. However, it is recommended to further study the attitude of policy makers towards PAS's glass box transparent approach. Although transparency largely has a positive connotation, according to Scholtes (2012, p. 343-345) it is not an

unambiguous concept nor a simple concept. She indicates that associations with 'objective', 'just' and 'verifiable' are made transparent, but it is also a normative concept that will bring about effects.

Use PAS as a game

While decision systems focus predominantly on providing its users with a solution, i.e. making decisions, gaming focuses predominantly on the learning experience of its users. PAS combines both by creating a solution and focus on learning at the same time. In PAS, stakeholders learn, because just as in gaming, they are confronted with the consequences of their actions and those of others and have the possibility to act upon them. It could be worthwhile to test PAS solely as a game.

Focus solely on evaluating of the new PAS design and decision approach

From a research methods perspective it is recommended to perform a PAS process and fully focus on evaluating PAS. This evaluation should be approached from both a soft and a hard systems perspective from the start. Next to that, a comparative research set-up with other approaches, as has been done in the third pilot, could be useful.

10.2.2 Professionalizing PAS

Professionals in practice are able to perform the PAS using the descriptions in paragraphs 4.3, 4.4. and 4.5 as well as 9.2 and 9.3. The examples of the pilots in chapter 5, 6 and 7 can serve as an aid. This does not alter the fact that a user-friendly manual can be made in the follow-up to this PhD research to professionalize PAS for practice. The following recommendations have been formulated:

Creating a web-based tool for generic PAS steps

Now that it is clear that stakeholders can perform all PAS steps, it is worthwhile to professionalize PAS by creating a generic web-based tool or app to support the execution of steps 1 to 4. In conjunction with the decision tool, a PAS introduction should be made in which both the method, an example, as well as the PAS foundations need to be addressed. The evaluation has shown that PAS interfaces could be improved in three ways: firstly, by using less interfaces and less content per interface and by experimenting with visualizing the portfolio. Secondly, by better explaining the backend of the model, making it possible for the users to understand

the relationships between the variables and the interventions even more quickly. Thirdly, by experimenting with a (partially) stakeholder operated model. Next to that, some stakeholders would benefit from more time for the PAS process with both individual and group workshops.

Develop PAS and an expert reference model

Some PAS interfaces had a direct relation to another CRE alignment model, namely the Designing an Accommodation Strategy (DAS) frame. PAS was used as add-on to the DAS model. The relationship between both models is not a perfect fit. Given the recommendation to use less interfaces and less content per interface, it is recommended to study whether stakeholders benefit from an explicit connection with DAS or not. Given the reflection in chapter 9, it seems to be preferred to work with PAS on the one hand and combine it with a purely substantive reference model on the other hand.

This purely substantive reference model can be built based upon the existing CRE alignment models. Since many stakeholders are involved in CRE alignment problems only incidentally, sharing state of the art knowledge is important. During the study, it has been noticed that many of these CRE alignment models are not known in practice. Therefore, it is recommended to enhance the accessibility of these existing reference CRE alignment models or create an expert system.

The additional design tools in all pilots have not been used much. It is recommended to research whether a reference model, as used in the first pilot, can be of more use if it is offered earlier in the process to the stakeholders, when defining their design variables.

Use PAS with an internal or external PAS facilitator and system engineer

Some organizations might prefer to use an external facilitator and system engineer to operate PAS, while other organizations may have the capabilities to do this themselves. It has substantial advantages for stakeholders to determine their preferences curves and to collaboratively design alternative CRE portfolios. Firstly, it allows for their demand to be better understood and secondly they themselves will better understand their own demand and that of others. It will raise awareness of the complex CRE alignment problem. However, since this approach is so different from approaches familiar to them, a facilitator helps them to embark in this new approach. At first this might not be easy, but the experience in the three pilots showed that two different facilitators were able to do so.

References

- Ackoff, R. L., & Sasieni, M. W. (1968). *Fundamentals of Operations Research*. Oxford: Wiley.
- Appel-Meulenbroek, R., Brown, M. G., & Ramakers, Y. (2010). *Strategic alignment of corporate real estate*. Paper presented at the European Real Estate Society (ERES) Conference, Milano.
- Appel-Meulenbroek, R. (2010). Knowledge sharing through co-presence: added value of facilities. *Facilities*, 28(3/4), 189-205.
- Arkesteijn, M., Binnekamp, R., & De Jonge, H. (2017). Improving decision making in CRE alignment, by using a preference-based accommodation strategy design approach. *Journal of Corporate Real Estate*, 19(4), 239-264.
- Arkesteijn, M., Valks, B., Binnekamp, R., Barendse, P., & De Jonge, H. (2015). Designing a preference-based accommodation strategy: a pilot study at Delft University of Technology. *Journal of Corporate Real Estate*, 17(2), 98-121.
- Arkesteijn, M. H., & Binnekamp, R. (2013). Real estate portfolio decision making. In A. V. Gheorghie, Macera, M. and Katina, P.F. (Ed.), *Infranomics: Sustainability, Engineering Design and Governance* (pp. 89-99.). Dordrecht: Springer.
- Arkesteijn, M. H., & Heywood, C. (2013). *Enhancing alignment processed between CRE & organisational strategy*. Paper presented at the Corenet Global EMEA summit, Amsterdam
- Barendse, P., Binnekamp, R., De Graaf, R., Van Gunsteren, L., & Van Loon, P. (2012). Operations Research Methods: For managerial multi-actor design and decision analysis. In: Amsterdam: IOS Press.
- Barzilai, J. (2007). *On the Mathematical Foundations of Economic Theory*. Dept. of Industrial Engineering, Dalhousie University, Halifax, Nova Scotia, Canada. Retrieved from <http://scientificmetrics.com/publications.html>.
- Barzilai, J. (2010). Preference Function Modelling: The Mathematical Foundations of Decision Theory. In M. Ehrgott, J. R. Figueira, & S. Greco (Eds.), *Trends in Multiple Criteria Decision Analysis* (pp. 57-86). Boston, MA: Springer US.
- Barzilai, J. (2015). An elementary demand theory error.[Retrieved from <https://youtu.be/L8dA544TFwA>; <http://scientificmetrics.com/presentations.html>
- Barzilai, J. (2016). *A Unified Consumer Demand Theory*. Dalhousie University. Halifax, Nova Scotia, Canada. Retrieved from http://scientificmetrics.com/downloads/publications/Barzilai_2016_Unified_Demand_Theory.pdf
- Belton, V., & Stewart, T. (2002). *Multiple criteria decision analysis: an integrated approach*: Springer Science & Business Media.
- Binnekamp, R., Van Gunsteren, L. A., & Van Loon, P. P. (2006). *Open Design, a Stakeholder-oriented Approach in Architecture, Urban Planning, and Project Management*. Amsterdam: IOS Press.
- Binnekamp, R. (2010). *Preference-based design in architecture*: IOS Press.
- Brackertz, N. and Kenley, R. (2002). A service delivery approach to facility performance for local governments. *Facilities*, 20(3/4), 127-135.
- Brute-force search. (2018). Retrieved from https://en.wikipedia.org/wiki/Brute-force_search d.d. 2019-05.
- Chaffee, E.E. (1985). Three models of strategy, *Academy of Management Review*, Vol. 10 No. 1, pp. 98-98. CoreNet Global. (2015). *The essential guide to corporate real estate* (1st ed.). Atlanta, Georgia: Corenet Global, Inc.
- De Chernatony, L., & Harris, F. (2000). Added value: its nature, roles and sustainability. *European Journal of Marketing*, 34(1/2), 39-56.
- De Graaf, R. (2018). [Descriptions of the functions].
- De Jonge, H., Arkesteijn, M. H., Den Heijer, A. C., Vande Putte, H. J. M., & De Vries, J. C. (2008). *Corporate real estate management: Designing an Accommodation Strategy (DAS Frame)*. Delft. Department Real Estate and Housing, Faculty of Architecture, TU Delft.

- De Jonge, H., Arkesteijn, M. H., den Heijer, A. C., Vande Putte, H. J. M., de Vries, J. C., & van der Zwart, J. (2009). *Corporate Real Estate Management. Designing an Accommodation Strategy (DAS Frame)*. Delft: Department Real Estate and Housing, Faculty of Architecture, TU Delft.
- De Leeuw, A.C.J. (2002). *Bedrijfskundig management* (second ed.): Koninklijke Van Gorcum.
- De Visser, H., Arkesteijn, M., Binnekamp, R., & De Graaf, R. (2017). *Improving CRE decision making at Oracle: Implementing the PAS procedure with a brute force approach*. Paper presented at the European Real Estate Society (ERES), Delft.
- De Visser, H. J. (2016). *Testing the improved PAS methodology: Implementation of a search algorithm*. (MSc MSc), Delft University of technology,
- De Vries, J. (2007). *Presteren door vastgoed*: Eburon Uitgeverij BV.
- De Vries, J. C., Van der Voordt, D.J M., & Arkesteijn, M.H. (2004). Afstemming organisatie en vastgoed [Alignment organisation and real estate] . In Van der Voordt D.J.M. and Den Heijer, A.C. (Ed.), *Inleiding vastgoedmanagement [Introduction Real Estate Management]* (pp. 164-183). Delft: Delft University of Technology.
- Den Heijer, A. (2011). *Managing the university campus - Information to support real estate decisions*. Delft: Eburon Academic Publishers.
- Dewulf, G., Den Heijer, A., de Puy, L., & Van der Schaaf, P. (1999). *Het managen van vastgoed binnen een publieke organisatie (managing real estate within a public organisation)*. Delft: DUP.
- Dunn, D., Ellzey, K., Valenziano, S. F., Materna, R., Kurtz, T., & Zimmerman, C. (2004). *CoRE 2010 Integrated Resource & Infrastructure Solutions*. Atlanta:
- Dym, C., & Little, P. (2004). *Engineering Design: A Project-Based Introduction*, Hoboken. In: NJ.: John Wiley & Sons Inc.
- Edwards, V., & Ellison, L. (2003). *Corporate property management: Aligning real estate and business strategy*. Blackwell Science: Malden, MA.
- Englert, J. (2001). *The Strategic alignment handbook*: IDRC.
- Franco, L. A., & Montibeller, G. (2010). Facilitated modelling in operational research. *European Journal of Operational Research*, 205(3), 489-500.
- Fritzsche, C., Hoepel, H., Kaper, L., & Van Ommeren, O. (2004). *Huisvesting is strategisch goed, wegwijzer voor vastgoedmanagement in ziekenhuizen (Real estate is a strategic asset, manual for real estate management in hospitals)*. Amersfoort: Twynstra Gudde Adviseurs en Managers
- Gerritse, C. (1999). *Kosten en kwaliteit: Sturing van de relatie kosten/kwaliteit in de vroege fasen van het huisvestingsproces*. Delft: Bouwmanagement en Vastgoedbeheer Technische Universiteit Delft Faculteit Bouwkunde.
- Gerritse, C. (2008). *Controlling Costs and Quality : in the early phases of the accomodation process*. Delft: VSSD.
- Haynes, B. P. (2008). Impact of workplace connectivity on office productivity. *Journal of Corporate Real Estate*, 10(4), 286-302.
- Heywood, C. (2011). "Approaches to aligning corporate real estate and organisational strategy" European Real Estate Society (ERES) Conference, *European Real Estate Society, Eindhoven*.
- Heywood, C., & Arkesteijn, M. (2017). Alignment and Theory in Corporate Real Estate Alignment Models. *International Journal of Strategic Property Management*, 21(2), 144-158.
- Heywood, C., & Arkesteijn, M. (2018). Analysing fourteen graphical representations of corporate real estate alignment models. *Journal of Corporate Real Estate*, 20(1), 16-40.
- Heywood, C., & Kenley, R. (2008). The Sustainable Competitive Advantage Model for corporate real estate. *Journal of Corporate Real Estate*, 10(2), 85-109.
- Heywood, C., & Kenley, R. (2013). *Five axioms for corporate real estate management: A polemical review of the literature*. Paper presented at the 18th Pacific Rim Real Estate Society (PRRES) Conference, Melbourne.
- Hofman, P. (2006, 31-01-2006). De filosofie van een weerloos citaat. Trouw, p. 1. Retrieved from <https://www.trouw.nl/nieuws/de-filosofie-van-een-weerloos-citaat> d.d. 2016-07
- ISO, BSEN (2005). 9000: 2005 Quality management systems. Fundamentals and vocabulary. *British Standards Institution*.
- Jensen, M. C. (2010). Value maximization, stakeholder theory, and the corporate objective function. *Journal of applied corporate finance*, 22(1), 32-42.

- Jensen, P. A., van der Voordt, T., & Coenen, C. (2012). *The added value of facilities management: concepts, findings and perspectives*: Polytechnisk Forlag Lyngby.
- Joldersma, C., & Roelofs, E. (2004). The impact of soft OR-methods on problem structuring. *European Journal of Operational Research*, 152(3), 696-708.
- Joroff, M., Louargand, M., Lambert, S., Becker, F. (1993). *Strategic management of the fifth resource: corporate real estate*.
- Kaplan, R. S., & Norton, D. P. (2006). *Alignment: Using the Balanced Scorecard to create corporate synergies*. Boston: Harvard Business School Press.
- Kraak, T., & Netten, M. (2013). *Effecten herziene curricula op ruimtegebruik*. Delft. Retrieved from
- Krumm, P., Dewulf, G. P., & De Jonge, H. (2000). What is corporate real estate? In *Successful corporate real estate*. Dewulf, G., P. Krumm & H. de Jonge eds. (pp. 27-34): Arko Publishers.
- Labovitz, G., & Rosansky, V. (1997). *The power of alignment: How great companies stay centred and accomplish extraordinary things*. New York: John Wiley & Sons.
- Lindholm, A. L., Gibler, K. M., & Leväinen, K. I. (2006). Modeling the value-adding attributes of real estate to the wealth maximization of the firm. *Journal of Real Estate Research*, 28(4), 445-475.
- Lindholm, A.-L., & Leväinen, K. I. (2006). A framework for identifying and measuring value added by corporate real estate. *Journal of Corporate Real Estate*, 8(1), 38-46.
- Markt gemeentelijk vastgoed zwaar onderschat. (2011). *Vastgoedmarkt*.
- Materna, R., & Parker, J. R. (1998). *Corporate infrastructure resource management: an emerging source of competitive advantage* (Research Bulletin No. 22). Atlanta.
- Mintzberg, H. (1994), The fall and rise of strategic planning, *Harvard Business Review*, January. Mintzberg, H., Ahlstrand, B., & Lampel, J. (1998). *Strategy Safari: The complete guide through the Wilds of Strategic Management*. London, Pearson Education Limited.
- Mintzberg, H., Ahlstrand, B., & Lampel, J. (2005). *Strategy bites back: It is far more, and less, than you ever imagined*. London, Pearson Education Limited.
- Mouter, N. (2012). *Voordelen en nadelen van de Maatschappelijke Kosten en Baten analyse nader uitgewerkt*. Paper presented at the Colloquium Vervoersplanologisch Speurwerk, Amsterdam.
- Nourse, H. O., & Roulac, S. E. (1993). Linking Real Estate Decisions to Corporate Strategy. *Journal of Real Estate Research*, 8(4), 475-494.
- O'Mara, M. A. (1999). *Strategy and place: managing corporate real estate and facilities for competitive advantage*. New York: The Free Press.
- Osgood Jr, R. T. (2004). Translating organisational strategy into real estate action: The strategy alignment model. *Journal of Corporate Real Estate*, 6(2), 106 - 117.
- Porter, M. E. (1985). *Competitive advantage: Creating and sustaining superior performance*. New York, NY: Free Press.
- Ragsdale, C. T. (2008). *Managerial Decison Modeling* (revised edition ed.). Mason, Ohio, USA: South-Western, a part of Cengage Learning.
- Revealed preference. (2019). Retrieved from https://en.wikipedia.org/wiki/Revealed_preference
- Riedel, R., Fransoo, J., Wiers, V., Fischer, K., Cegarra, J., & Jentsch, D. (2010). Building decision support systems for acceptance. In *Behavioral operations in planning and scheduling* (pp. 231-295): Springer.
- Riratanaphong, C., Van der Voordt, D. J. M., & Sarasoja, A. L. (2012). Performance measurement in the context of crem and fm. In P. A. Jensen, D. J. M. Van der Voordt, & C. Coenen (Eds.), *The added avlue of facilities management: concepts, findaings and perspectives*. Lyngby: Polytechnisk Forlag.
- Roadmap Onderwijsruimtes TU Delft (v1.0) (Roadmap Educational Spaces). (2014). TU Delft. Delft.
- Roulac, S. E. (2001). Corporate property strategy is integral to corporate business strategy. *Journal of Real Estate Research*, 22(1/2), 129-152.
- Scheffer, J. J. L., Singer, B. P., & Van Meerwijk, M. C. C. (2006). Enhancing the contribution of corporate real estate to corporate strategy. *Journal of Corporate Real Estate*, 8(4), 188-197.
- Scholtes, H. H. M. (2012). *Transparantie, icoon van een dolende overheid*. Boom Lemma Den Haag, The Netherlands.
- Schön, D. A. (1987). *The reflective practitioner: how professionals think in action*. San Francisco: Jossey-Bass.
- Scientific Metrics, (2002-2016). *Tetra Quickstart Guide*. Retrieved from <http://scientificmetrics.com/downloads/sdm/Tetra%20Quickstart%20Guide.pdf>

- Sharp, D. (2013). Risks ahead: the transformation of the corporate real estate function. *Journal of Corporate Real Estate*, 15(3/4), 231-243.
- Simon, H. A. (1997). *Administrative Behavior: A Study of Decision-Making Processes in Strategic Decision Making Processes in Administrative Organizations*. (4th ed.). New York: MacMillan.
- Snyder, N. and Glueck, W.F. (1980), How managers plan – the analysis of managers' activities, *Long Range Planning*, Vol. 13 No. 1, pp. 70-76.
- Tazelaar, J., & Schonau, W. (2010). *Professioneel gemeentelijk vastgoed; stand van professionalisering bij gemeenten Amersfoort*.
- Tetra Quickstart Guide*. (2002-2016). Scientific Metrics. Retrieved from <http://scientificmetrics.com/downloads/sdm/Tetra%20Quickstart%20Guide.pdf> retrieved 21-12-2018.
- Teuben, B. J. J., Waldmann, M., & Hordijk, A. C. . (2007). *An Inventory of Municipal Real Estate; The case of the Netherlands*. Paper presented at the European Real Estate Society, ERES 2007, London, UK.
- Then, D. S.-S. (2005). A proactive property management model that integrates real estate provision and facilities services management. *International Journal of Strategic Property Management*, 9(1), 33-42.
- Then, D. S. S., & Tan, T. H. (2010). *Real estate and facilities management alignment to business needs: A conceptual model*. Paper presented at the International Conference on Construction and Real Estate Management, Brisbane.
- Then, D. S.-S., & Tan, T. H. (2013). *Facilities management and the business of managing assets*. Abingdon: Routledge.
- Then, D. S.-s., Tan, T.-h., Santovito, R. F., & Jensen, P. A. (2014). Attributes of alignment of real estate and facilities management to business needs: An international comparative analysis. *Journal of Corporate Real Estate*, 16(2), 80-96.
- Valks, B. (2013). *Designing and Testing a Strategy Game*. (MSc MSc), Delft University of technology, Delft.
- Van der Schaaf, P. (2002). *Public Real Estate Management; Challenges for Governments*. Delft: DUP Science.
- Van Der Zwart, J. (2014). *Building for a better hospital: Value-adding management & design of healthcare real estate*. Delft: Architecture and the Built environment, TU Delft.
- Van der Zwart, J., Arkesteijn, M. H., & Van der Voordt, D. J. M. (2009, 2-3 April). *Ways to study corporate real estate management in healthcare: an analytical framework*. Paper presented at the HaCIRIC conference (Health and Care Infrastructure Research and Innovation Centre), Brighton,UK.
- Van Loon, P. P. (1998). *Interorganisational design: a new approach to team design in architecture and urban planning*. Delft: Publicatiebureau Bouwkunde.
- Van Loon, P., Barendse, P., & Duerink, S. (2012). *The Urban Decision Room: A multi actor design engineering simulation system*. Paper presented at the CESUN 2012: 3rd International Engineering Systems Symposium, Delft University of Technology, The Netherlands, 18-20 June 2012.
- Van Loon, P. P., Heurkens, E. W., & Bronkhorst, S. . (2008). *The urban decision room*. Amsterdam: IOS Press.
- Vijverberg, G. (2002). Accommodation functionality assessment in office buildings. *Facilities*, 20(3/4), 94-103.
- Volker, L. (2010). *Deciding about Design Quality: Value judgements and decision making in the selection of architects by public clients under European tendering regulations*: Sidestone Pr.
- Weatherhead, M. (1997). *Real estate in corporate strategy*. Houndmills, Basingstoke: Macmillan Press
- White, A. D. (1998). Corporate real estate strategies: Managing the delivery of optimum solutions. *Journal of Corporate Real Estate*, 1(1), 64-74.
- Whitley, R. (2000). *The intellectual and social organization of the sciences*: Oxford University Press on Demand.
- Wills, P. C. (2005). *Aligning Corporate real estate and business strategies*. Paper presented at the 11th Pacific Rim Real Estate Society (PRRES) Conference, Melbourne.
- Wills, P. C. (2008). Corporate real estate practice in Australia. *Journal of Corporate Real Estate*, 10(1), 40-53.
- Wilson, C., Hagarty, D., & Gauthier, J. (2004). Results using the balanced scorecard in the public sector. *Journal of Corporate Real Estate*, 6(1), 53-64.

Appendices

Designing an Accommodation Strategy (DAS)

A frame to design an accommodation strategy, the so-called DAS frame (De Jonge et al., 2008, 2009) has been developed. In her dissertation Den Heijer (2011) extended the DAS frame and Van der Zwart (2014) in his dissertation elaborated on the DAS frame.

In this appendix, for the readers that are not familiar with the frame, The DAS frame is elaborated upon.

The strength of the DAS frame, as has been noted by Heywood and Arkesteijn (2018), is its simplicity. It shows clearly and conveniently the necessary steps in designing an accommodation strategy. To be more concrete about what to do in every step, and how, (De Jonge et al., 2009 and Vander Zwart et al., 2009) conducted a literature review of other ideas, concepts and models from different strategy perspectives that could support the design of an accommodation strategy. This so-called strategic pluralism approach has been elaborated by linking the DAS Frame to six CRE alignment models: The models they studied were:

- Scenario planning from Dewulf et al. (1999);
- Generic strategies and context analysis of O'Mara (1999);
- Accommodation assessment Vijverberg (2002);
- Strategic real estate plan from Fritzsche et al. (2004);
- Aligning corporate real estate from Roulac (2001) ;
- Strategic alignment model from Osgood (2004).

The first conclusion of this review is that the different models have different focuses on the axes from demand to supply, and from current to future. The results of the review have been visualized as elaborated framework (see Figure APP.A.1). It shows what can be taken into account, for instance: to determine current demand: Dewulf et al.(1999) and Osgood (2004) show us to study the organizational strategy; Roulac (2001) the sources of competitive advantages and O'Mara (1the strategic

environment and the organizational demands, while Fritzsche et al refer to the strategic orientation of the organization.

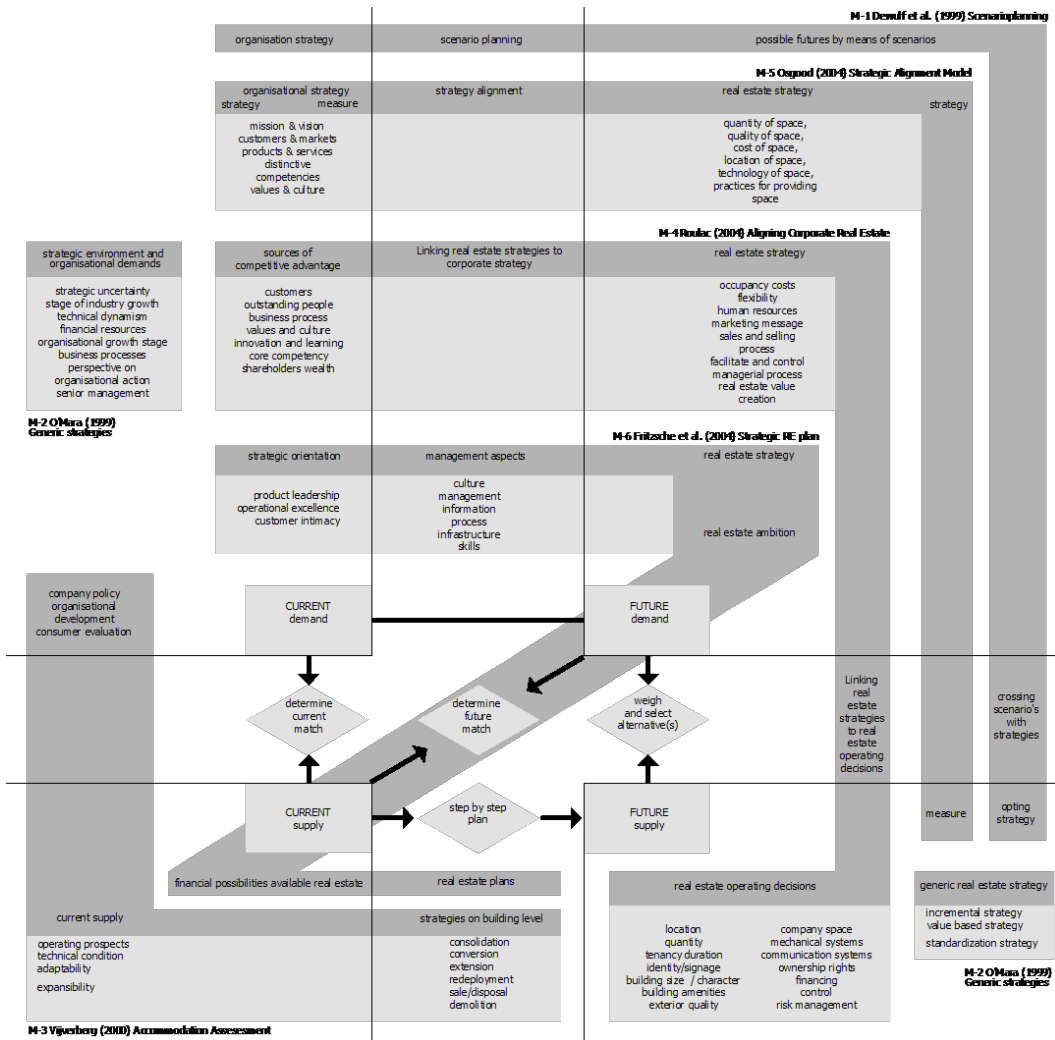

FIG. APP.A.1 Elaboration of the DAS frame by connecting the different steps to other CRE alignment models (De Jonge et al., 2009, p. 93 and Van der Zwart, et al., 2009)

This elaborated DAS-framework can be used in several ways: (1) ex ante to steer and to support decision making on present and future demand and supply as a starting point to designing an accommodation strategy that is linked to corporate business

strategy; (2) ex post to test current real estate management strategies with regard to consistency, completeness and best possible fit between organizational goals and objectives and organizational resources including real estate, now and in the long run.) have been combined in a more integrated analytical framework

DAS Frame from a design and decision perspective

From a design and decision perspective, two things about the DAS frame are clear when studying the frame. The first is that design is an important part of the framework since it represents the first letter of the acronym DAS; designing an accommodation strategy. The design takes place in the third steering event 'Alternatives of what we could have': design, evaluate and select solutions for the mismatch. When explaining this steering event, the authors subdivide this into two questions: subtask (a) What are possible solutions? And subtask (b) How can they be evaluated by all stakeholders? Firstly, the alternatives are designed and subsequently one alternative is selected, i.e. a decision is made. The authors show how this can be done by giving examples but do not elaborate on how this is done exactly. The word design is not explicitly mentioned in graph.

“In quite a lot of ways, outlining an accommodation strategy resembles the design process: analysis aims (1) to draw up a program of requirements, (2) to understand what the problem is and what is required, (3) to study examples of similar problems, and consequently, (4) to obtain an understanding of (sub)solutions. Since every situation is unique, such sub-solutions cannot be transferred to new situations one-on-one. A conversion is necessary, or rather: a specific, unique design. A draft design is made, which is linked to the program of requirements and debated with the client. Because knowledge progresses over time, requirements change or are given a different level of importance” (De Jonge et al, 2009, p. 7).

“This book therefore contributes to:

- An analysis process to clarify demand. Several methods are recognized that unveil the accommodation mismatch for the specific situation in which an organization finds itself.
- Understanding the necessary leap from analysis to outlining the strategy/strategies. Usually, this step involves a creative event, but may also involve a process of weighing-up, based on criteria. For the latter, the leap predominantly involves the assessment of determining the criteria for consideration: in which direction does the solution point?

- Substantiation of the iterative process of evaluating the outlined strategy on the basis of the problem or question formulated. The evaluation should be repeated until the match is satisfactory. This means that not only the question, the ensuing criteria and consideration factors may change, but the strategy and its elaboration may change as well.
- Understanding the need for information and the process stages involved, based on the DAS framework” (De Jonge et al, 2009, p. 7).

This means that the basic DAS framework is linked to the content of other models. Based on this link to the other models two observations were made, which determined the focus of this research. The first observation was that the formation of alternatives was approached in two different ways in the models that were studied: “a distinction can be made between methods that (1) consider a real estate strategy as a choice from preset generic strategies or as (2) a consideration of alternatives” (De Jonge et al., 2009, p. 85). The latter models do indicate that alternatives need to be formed but do not explain how this needs to be done. The second observation is that the models indicate what kind of techniques can be used when making a decision, i.e. how to select a strategy . However, decision making receives very little attention in the models.

Although, the DAS framework has its roots in the design tradition and the systems approach, this is mostly implicit. One could state that most attention goes to the analysis; what needs to be taken into account, and less to the synthesis. i.e. how the different stakeholders interest are actually integrated.

The DAS framework is further developed by Den Heijer (2011) in her dissertation on Managing the university campus. She enhanced the DAS Frame by defining tasks (instead of steering events) and adding an extra diamond shape for “exploring changing demand” and she changed the focus towards university campus managers. Next to that, the CREM perspectives and the ways CRE can add value to the organization have been connected to the DAS framework (see Figure APP.A.2)

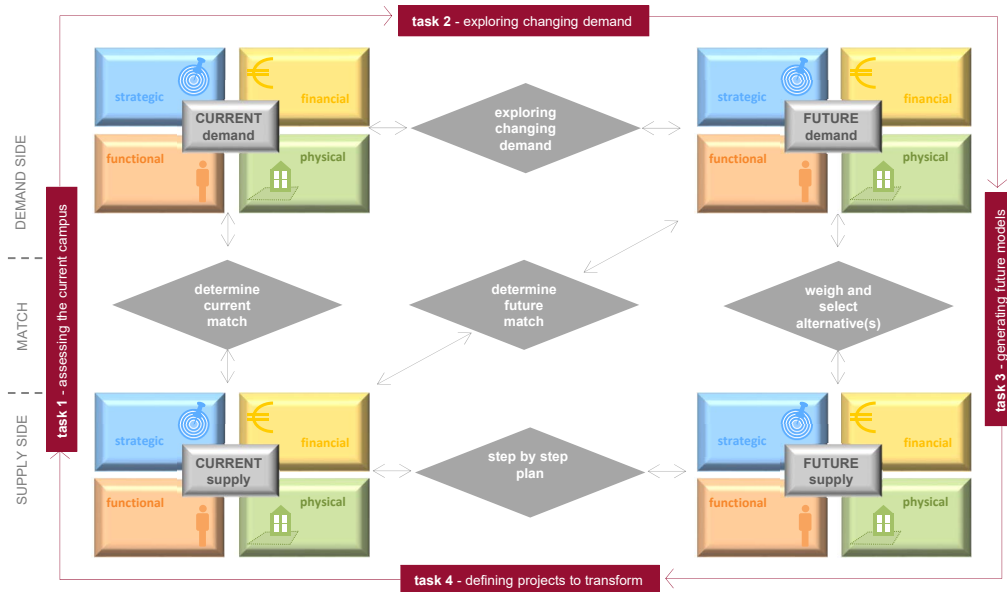

FIG. APP.A.2 Two combined approaches connecting the DAS Frame to four different stakeholder perspectives and their ways to add value Note from Den Heijer (2011, p. 115)

Van der Zwart (2014, p. 12) took a different approach by “paralleling existing conceptual models in CREM models that control the quality of the organizational processes. The basic conceptual model for this is an abstraction of the European Foundation for Quality Management (EFQM) model in four steps: (1) stakeholders objectives, (2) the organization’s key issues for success, (3) managing the organization’s structure and resources; (4) improvement of the primary process. The plan-do-check-act cycle as common ground in quality management is also included in this basic conceptual model.”

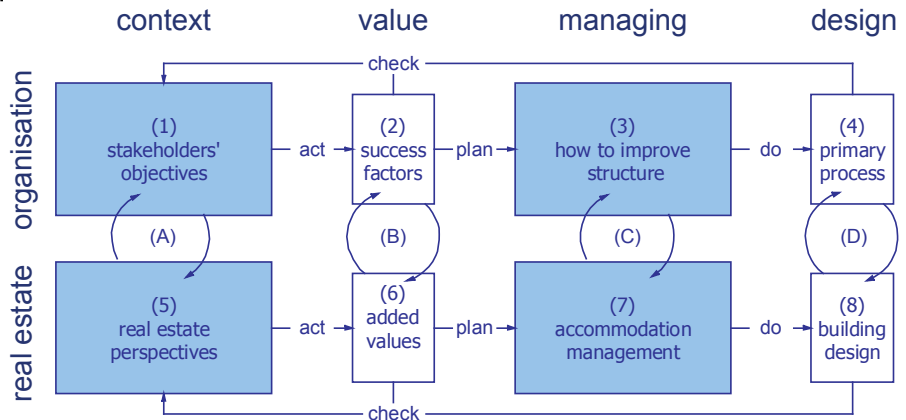

FIG. APP.A.3 Meta model Note from Van der Zwart (2014, p. 12)

Contrary to Den Heijer, Van der Zwart positioned the added values (#6) and the DAS Frame (#7) next to each other instead of integrating them. Both of them did not focus on decision making and design of alternative portfolios.

Link assessment criteria and labels

		Label of requirement	1st Assessment of 7 CRE alignment models		2nd Assessment of 14 CRE alignment models			3rd Assessment of 14 CRE alignment models	
			(1) are mathematical operations are used	(2) for the methods using mathematical operations, have strong, proper or weak scales been used	(1) Is the method an evaluation or a design method?	(2) Are scales used to determine whether quantitative and qualitative requirements are met and are they established directly by decision makers?	(3) Is the performance on criteria aggregated into an overall performance rating?	(1) black box or transparent 'glass' box for decision making	(2) do the models have a substantive approach in which it is clear how the (best) alternative is chosen
1	DEMAND	Integral							
2		explicit							
3		personal							
4	SUPPLY ALTERNATIVES	design method							
5		iterative							
8		optimal (added value)							
6	SELECT ALTERNATIVE	Indisputable					is it clear how the best option is chosen so that can be determined whether or not these criteria are fulfilled		
7		correct	focus on correct measurement						

Example of the Preference-Based Design procedure

This methodology is at the core of this thesis and in order to make it more insightful for readers that are not familiar with the Preference-Based Design (PBD) an example Binnekamp (2010, pp. 94-96, 118) uses in his paragraph 6.3 is shown⁷⁹.

Step 1: Specify the decision variables the decision maker is interested in

The following decision makers are identified along with the decision variables they are interested in:

- The Ministry of Finance is interested in the investment (decision variable i in billion dollars).
- The airlines are interested in the time (decision variable t in hours) passengers would have to spend in the shuttle.
- The Ministry of Environment is interested in the distance (decision variable d in kilometers) between the island and the shore.
- The airport is interested in the number of flight movements (decision variable f in 100k flight movements).

Step 2: Rate the decision maker's preference for at least three values for each decision variable value

- The Ministry of Finance rates a (synthetic) alternative that would cost 15 billion dollars at 100 and an alternative that would cost 40 billion dollars at 0. A third alternative costing 20 billion dollars is rated at 20.

⁷⁹ The tables are enriched with arrows pointing out certain elements as well as explanations.

- The airlines rate an alternative that requires passengers to spend 0.5 hours in the shuttle at 100 and an alternative that requires them to spend 0.9 hours at 0. A third alternative that would require them to spend 0.7 hours is rated at 45.
- The Ministry of Environment rates an alternative that has a distance of 40 kilometers between the island and the shore at 100 and an alternative that has a distance of 20 kilometers at 0. A third alternative that has a distance of 30 kilometers is rated at 70.
- The airport rates an alternative with 10 x 100k flight movements at 100 and an alternative with 6 x 100k flight movements at 0. A third alternative with 8 x 100k flight movements is rated at 20.

Step 1 and 2 are displayed for one decision variable in **Figure APP.C.1**.

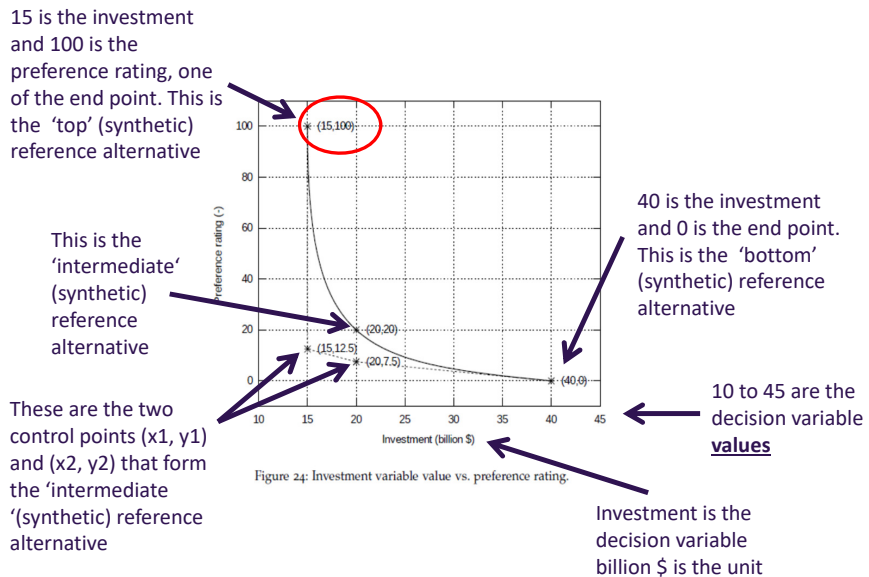

FIG. APP.C.1 Example PBD step 1 and 2 Note adapted from Binnekamp (2010, p. 111)

Step 3: To each decision variable assign decision maker's weights

For this experiment all decision variables are weighted equally.

Step 4: Determine the design constraints

For this experiment two design constraints were used.

- The first relates the distance between the island and the shore (decision variable d in kilometers) and the time passengers have to spend in the shuttle (decision variable t in hours) using a postulated shuttle speed of 120 kilometers per hour:

$$\frac{d}{120} \quad (6.1)$$

The second design constraint relates the number of flight movements (decision variable f in 100k flight movements), the distance between the island and the shore (decision variable d in kilometers) and the investment (decision variable i in billion dollars). Given that building an island for 600k flight movements at a distance of 10 kilometer from the shore would cost 15 billion dollars, the investment increases with 0.15 billion dollars per 100k flight movements more than 600k and increases with 0.2 billion dollars per kilometer more distance from the shore than 10 kilometer:

$$15 + 0,15(f-6) + 0,2(d-10) \quad (6.2)$$

Step 5: Combine decision variable values to generate design alternatives and use the design constraints to test their feasibility

Based on the information it was possible to generate 14 641 possible combinations of decision variable values (the number of decision variable values to the power of the number of decision variables). Then, all alternatives are analyzed on their feasibility and the feasible ones are fed into the PFM software.

Step 6: Use the PFM algorithm to yield an overall preference scale of all feasible alternatives

Figure APP.C.2 shows the top 10 of feasible alternatives (combinations of decision variable values that satisfy the design conditions) ordered on the overall preference rating yielded by the PFM algorithm. From this table it can be concluded that alternative 396 requiring the passengers to spend of 0.5 hours in the shuttle at a distance of 31.4 kilometers from the shore with 10 x 100k flight movements costing 20 billion dollars is both feasible and the most preferred alternative.

Alt.	Decision variable				Pref.	←	Alt. - alternative i - investment t - travel time d - distance f - flight movements Pref. - preference
	<i>i</i>	<i>t</i>	<i>d</i>	<i>f</i>			
396	20	0.5	31.40	10	80.144		
1430	22.56	0.5	40	10	79.969		
385	20	0.5	29.43	10	79.281		
1419	22.56	0.5	36.58	10	78.677		
374	20	0.5	27.75	10	78.318		
1429	22.56	0.5	40	9.73	78.255		
1551	22.56	0.55	40	10	78.151		
1408	22.56	0.5	33.74	10	77.852		
363	20	0.5	26.25	10	77.157		
1397	22.56	0.5	31.40	10	77.083		

FIG. APP.C.2 Top 10 of feasible alternatives with associated decision variable values and preference ratings
 Note adapted from Binnekamp (2010, p. 118)

Preference ratings objects

In the Table below the preference ratings⁸⁰ from the stakeholders for the criteria ambience, coziness and findability is given

	variable	11	15	17
	unique variable	U8	U10	U17
Faculty	building number	ambience	cosyness	findability
ARCH	8	90	55	90
ARCH	8	90	55	90
Auditorium	20	20	70	100
Library	21	60	20	90
CEG	23	20	15	0
CEG	23	60	15	90
TPM	31	40	35	100
IDE	32	80	45	100
3ME	34	20	45	90
EEMCS	36	40	30	0
Sports Centre	37	100	80	100
Inholland	40	100	70	100
Reactor	50	50	30	90
AE	62	60	60	90
TNW	no current facility			

⁸⁰ For two of the three criteria the stakeholders did not give the rating 0, this is an omission and should be done in future studies.

Additional design tools

In the first pilot study food facilities three additional design tools were used.

Displaying available food facilities within maximum walking distance

In this particular pilot study the walking distance was of such an importance as a design variable as it was defined by three different stakeholders. Therefore, an additional design tool was made that showed whether or not from a particular faculty building a food facility was available or not. This was done both for concept middle (including current lunch facilities) and concept large (including current facilities with dinner). If from that faculty building a facility was available a green dot was added to the faculty building but if not a red dot. In [Figure APP.E.1](#) an example is displayed of an alternative which did not offer a facility within maximum walking for each faculty building (see right side of the map).

Task 1 and 3 Current match; generating future models

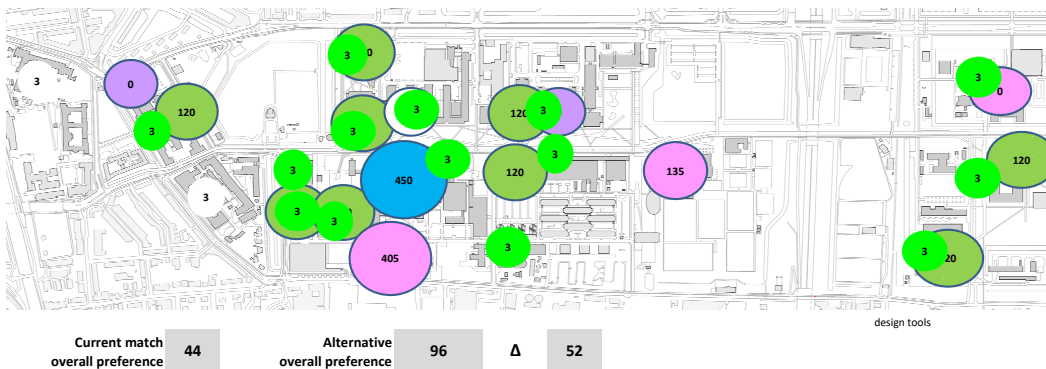

FIG. APP.E.1 Food facility middle available within the minimum required walking distance from a faculty

Based upon observation of the facilitator this design tool was hardly used during the workshops.

Benchmark data

During the first workshop based on the collected information four benchmark graphs were shown to the stakeholders. Below the benchmarks are shown, in [Figure APP.E.2](#), [Figure APP.E.3](#) and [Figure APP.E.4](#) for instance the square meters (m² g.f.a.) per place (seat) in a food facility. In each overview, all buildings were taken into account that have a certain food facility.

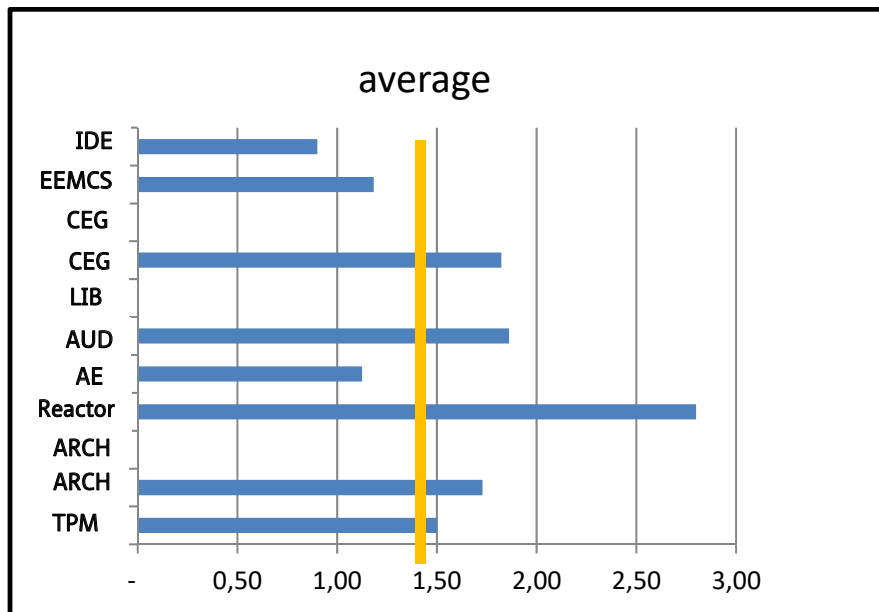

FIG. APP.E.2 Benchmark m² g.f.a per place (seat) in a food facility for lunch or dinner

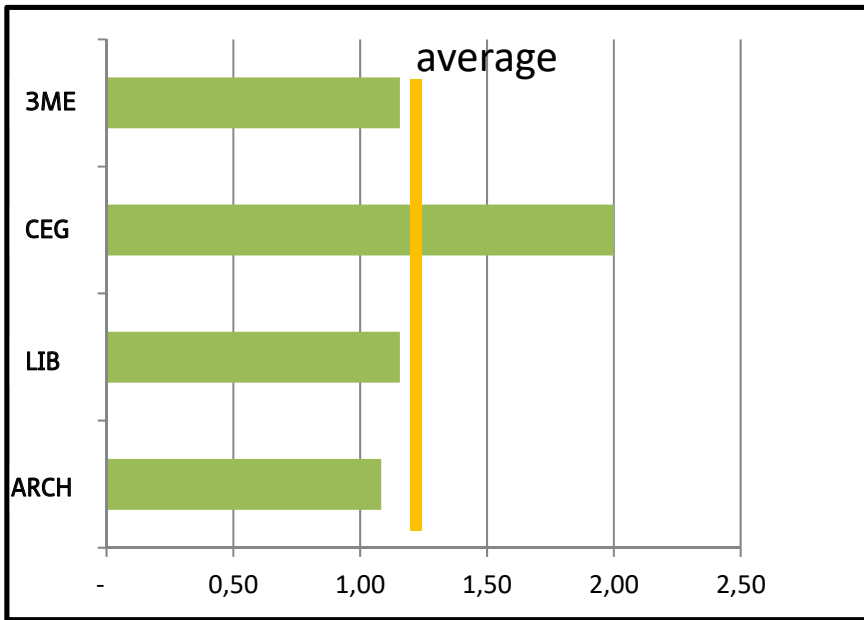

FIG. APP.E.3 Benchmark m² g.f.a per per place (seat) in a coffee corner

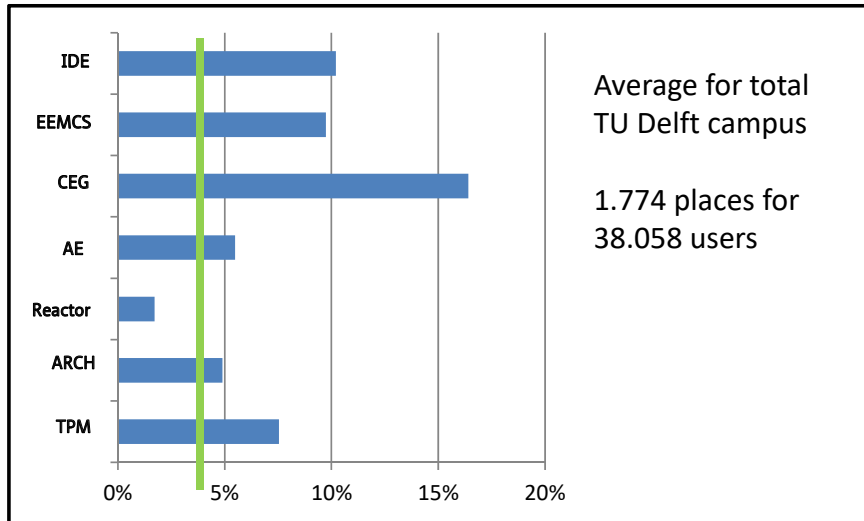

FIG. APP.E.4 Benchmark % places (seats) for all users

This overview was shown to the stakeholders. None of the stakeholders asked about the benchmark in a later stage. From observation it seemed the tool was not used.

Reference model to support stakeholders to translate objectives into relevant decision variables

In this pilot study, a reference model was used in the separate workshop. The use of reference models is common in management as well as in CREM (see chapter 2). In chapter 2 and 3 it was shown that in order to enable stakeholders to select an alternative real estate portfolio that adds the most value to their organization it is important to translate objectives into decision variables, i.e. criteria or key performance indicator (KPI). A reference model supports stakeholders to select criteria that could be relevant. The use of a reference model is optional.

Many reference models exist in CREM, however not many of these models focus specifically on university real estate. Since the pilot study was performed at Delft University of Technology the model of Den Heijer was chosen for this particular pilot as reference model. A tool was built (in MS Excel), based on the information in Den Heijer (2011, pp. 245-247; Figure 8.3, Table 8.1 and Table 8.2) to enhance the accessibility of the information. The stakeholders are guided in three steps from university objectives (output), to real estate goals (throughput; ways to add value) to relevant key performance indicators on campus and city level as well as tools to measure them.

The structure of the tool 'Den Heijer Variable check' is based on three steps shown in [Figure APP.E.5](#).

In the subsequent figures the different steps are illustrated. In the first step in [Figure APP.E.6](#) the stakeholders can select different university performance criteria, which represents the output the university can strive for. If a certain output is chosen only the related real estate goals appear.

In the second step (see [Figure APP.E.7](#)) the stakeholders can select a certain real estate goal and then only the related key performance indicators appear.

The stakeholders have the option to see tools that could measure these criteria as can be seen in [Figure APP.E.8](#), next to the relevant criteria. When using the tool the stakeholders were able to navigate within the tool but did not alter their criteria. The main comment of the stakeholders was that the criteria could be more specific. Not all stakeholders were present in this session.

Managing the university campus

Den Heijer Variable check

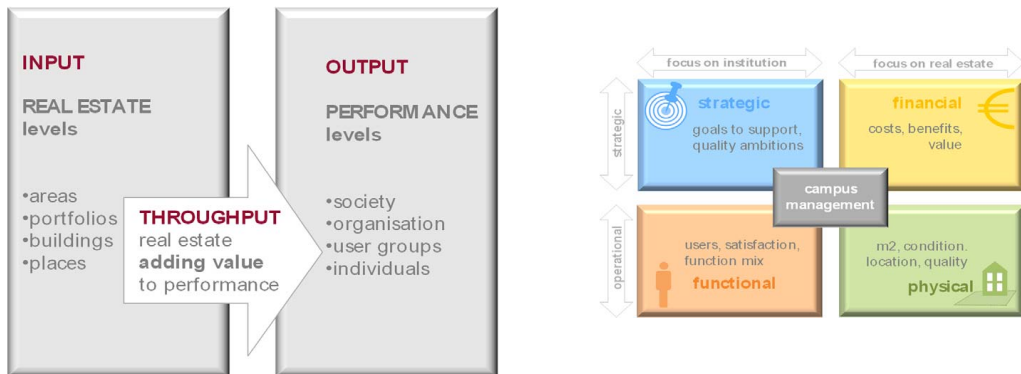

If you want to check whether or not you have incorporated all relevant variables, you can use information gathered in the dissertation of Alexandra den Heijer.

In order to so three steps have been identified:





- Step 1: Choose the university performance criteria you want by clicking on a criteria in the next worksheet
- Step 2: Choose the desired real estate goal by clicking on a goal, than relevant KPI's will be shown in the next worksheet
- Step 3: Click at step 3 in the next worksheet if you want to see relevant tools to measure the relevant KPI's

FIG. APP.E.5 Opening screen of reference model Note figures from Den Heijer, 2011, p. xiv

Step 1: choose the university performance criteria you want by clicking on a criteria		Step 2: choose the desired real estate goal by clicking on a goal, than relevant KPI's will be shown		
OUTPUT	THROUGHPUT			
university performance criteria	real estate goals: adding value			
competitive advantage				
productivity	increasing flexibility	increasing user satisfaction	supporting user activities	
profitability				
sustainable development				

FIG. APP.E.6 First step in reference model Note based on Den Heijer, 2011

Step 1: choose the university performance criteria you want by clicking on a criteria **Step 2: choose the desired real estate goal by clicking on a goal, than relevant KPI's will be shown**

OUTPUT	THROUGHPUT		
university performance criteria	real estate goals: adding value		
competitive advantage 			
productivity 	increasing flexibility	increasing user satisfaction	supporting user activities
profitability 			
sustainable development 			

Relevant KPI's on campus level

- student satisfaction over the years
- employee satisfaction, periodically

Relevant KPI's on city level

- available cafés, restaurants
- retail & leisure facilities
- units student housing
- quality of (student) housing
- hotel rooms, short stay apartments

FIG. APP.E.7 Second step in reference model Note based on Den Heijer, 2011

Step 1: choose the university performance criteria you want by clicking on a criteria **Step 2: choose the desired real estate goal by clicking on a goal, than relevant KPI's will be shown**





OUTPUT	THROUGHPUT				
university performance criteria	real estate goals: adding value				
competitive advantage 	improving quality of space	supporting image	supporting culture	stimulating innovation	stimulating collaboration
productivity 					
profitability 					
sustainable development 					
Relevant KPI's on campus level		<ul style="list-style-type: none"> •image before and after •use of building as marketing tool by users •opportunity costs (related to other marketing tools) 			
Relevant tools		<ul style="list-style-type: none"> •reputation monitor of user group (faculty or university) •project database: references on image and costs 			
Relevant KPI's on city level		<ul style="list-style-type: none"> •number of visitors •number of visitors related to the university •quality of knowledge base 			
		<ul style="list-style-type: none"> •rankings of cities (...) •reputation monitor •university rankings 			

FIG. APP.E.8 Third step in reference model Note based on Den Heijer, 2011

Matlab source for decision variable minimum walking time

The function `GetWalkTime` computes the minimum walking time from a faculty to all food facilities of a given concept. Note adapted from De Graaf (2018).

First, the function checks if a faculty or food facility is available, Then, the minimum walking time from a faculty to all food facilities of the given concept is computed. This procedure is repeated for each faculty. The function has two input parameters:

- 1 The code of the concept,
- 2 The state vector representing the new state of each food facility. Based on these states the concept of each food facility is determined.

The function `GetWalkTime` yields the value of the minimum walking time in minutes. The walking time from a faculty to a food facility is stored in a matrix. The result is the maximum walking time of all minimum walking times.

The function `GetWalkTime` computed for two concepts and three stakeholders (functions `Var_1`, `Var_2`, `Var_3`, `Var_4`, `Var_5` and `Var_6`)

```
function WalkTime = GetWalkTime(pConcept,nwState)
global wtOrDs avOrig avDest ecDest
global ConcChange ecData etDest etIntv ctIntv
function Concept = GetConcept(pLocation, pIntervention)
es = ecDest(pLocation);
Concept = 0;
switch (pIntervention)
case {1, 12, 13
```

```

Concept = etDest(es,pConcept);
case {3, 4, 5, 6, 7, 8, 9, 10, 11}
Concept = pConcept;
end;
end
maxWalkTime = 0;
%Calc min walking time to a faculty
for i = 1:length(avOrig)
if avOrig(i)== 1
minWalkTime = 999999;
for j = 1:length(avDest)
if avDest(j)== 1
tmWtm = wtOrDs(i,j);
tmInt = ConcChange(nwState(j),ecDest(j));
Concept = GetConcept(j, tmInt);
if Concept == pConcept
if tmWtm < minWalkTime
minWalkTime = tmWtm;
end
end;
end
end
if minWalkTime > maxWalkTime
maxWalkTime = minWalkTime;
end;
end
end
WalkTime = floor(maxWalkTime);
end

```

Descriptions of the functions

In this appendix the functions computing the ratings of the criteria are described.

Criterion⁸¹ Walking distance VAR_1 and VAR_2 (decision variables 1, 2, 7, 8, 12 and 13, respectively U1 and U2)

The function `GetWalkTime` computes the minimum walking time from a faculty to all food facilities of a given concept.

First, the function checks if a faculty or food facility is available. Then, the minimum walking time from a faculty to all food facilities of the given concept is computed. This procedure is repeated for each faculty. Finally, the result is the maximum walking time of all minimum walking times.

The function has two input parameters:

- The code of the concept;
- The state vector representing the new state of each food facility. Based on these states the concept of each food facility is determined.

The function `GetWalkTime` yields the value of the minimum walking time in minutes. The walking time from a faculty to a food facility is stored in matrix `wtOrDs`.

The function `GetWalkTime` is computed for concept *middle* (VAR_1) and *large* (VAR_2) and three stakeholders.

⁸¹ Criterion and decision variable are the same in this thesis as explained in chapter 3. The numbers of the decision variables are different to chapter 7 see Figure at the end of this appendix

**Criterion Percentage working places VAR_3
(decision variables 3, 9, 16, respectively U3)**

Depending on the concept change of the available food facilities this function computes the total number of seats and total number of working seats. These values are stored in two vectors. The function returns the percentage of the working places.

**Criterion Percentage of seats having sufficient acoustics VAR_4
(decision variable 10, respectively U7)**

This function computes the total number of seats and total number of seats having sufficient acoustics. These values are stored in two vectors. Depending on the concept change of the available food facilities this function computes the total number of appropriate food facilities this function returns the percentage of seats having sufficient acoustics.

**Criterion Ambience VAR_5
(decision variable 11, respectively U8)**

Depending on the concept change of the available food facilities this function computes the total number of appropriate food facilities and the sum of their ambience, which value is stored in a vector. This function returns the average ambience. It returns 0 if there are no appropriate food facilities.

**Criterion Average vertical location of all food facilities VAR_6
(decision variable 4, respectively U4)**

Depending on the concept change of the available food facilities this function computes the total number of appropriate food facilities and the number of floors, which value is stored in a vector. This function returns the average of the number of floors. It returns 0 if there are no appropriate food facilities.

**Criterion Accessibility VAR_ 7
(decision variable 5, respectively U5)**

This functions computes the average accessibility of all food facilities, being the average number of doors in a food faculty between its entrance and its food facility. Depending on the concept change of the available food facilities this function computes the total number of appropriate food facilities and the sum of the doors, which value is stored in a vector. This function returns the average number of doors. It returns 0 if there are no appropriate food facilities.

**Criterion walking time within a faculty to the food facility VAR_8
(decision variable 6, respectively U6)**

This function computes the average walking time in minutes from the entrance of a faculty to its food facility. Depending on the concept change of the available food facilities this function computes the total number of appropriate food facilities and the sum of walking times, which value is stored in a vector. This function returns the average walking time. It returns 0 if there are no appropriate food facilities.

**Criterion Diversity VAR-9
(decision variable 14, respectively U9)**

This function computes the percentage of food facilities labelled 'diverse'. Depending on the concept change of the available food facilities this function computes the total number of appropriate food facilities and the number of food facilities labelled 'diverse', which value is stored in a vector. This function returns the percentage of food facilities labelled 'diverse' and 0 if there are no appropriate food facilities.

**Criterion Coziness VAR_10
(decision variable 15, respectively U10)**

This function computes the average preference rating on coziness for all food facilities. These preferences are stored in a vector. Depending on the concept change of the available food facilities this function computes the total number of appropriate food facilities and the sum of all coziness preferences. This function returns the average of coziness preference and 0 if there are no appropriate food facilities.

**Criterion Findability VAR_11
(decision variable 17, respectively U11)**

This function computes the average preference rating on findability for all food facilities. This preferences are stored in a vector. Depending on the concept change of the available food facilities this function computes the total number of appropriate food facilities and the sum of all findability preferences. This function returns the average of findability preference and 0 if there are no appropriate food facilities.

Overview of decision variable numbers; unique numbers, decision variables numbers of the stakeholders and the numbers in the mathematical model in [Figure APP.G.1](#).

unique number	decision variables	number decision variables stakeholders				mathematical model number
U1	Maximum walking time from a faculty building to a food facility for lunch [minutes]	1	7	12		VAR_1
U2	Maximum walking time from a faculty building to a food facility for dinner [minutes]	2	8	13		VAR_2
U3	Percentage of places in all food facilities which can be used for working [%]	3	9		16	VAR_3
U4	Average vertical location of food facility [floors]	4				VAR_6
U5	Amount of doors between outside and the food facility [doors]	5				VAR_7
U6	Average walking time from an entrance to a food facility [minutes]	6				VAR_8
U7	Percentage of places in the facilities having sufficient acoustics [%]		10			VAR_4
U8	Average preference rating on ambience for the food facilities [-]		11			VAR_5
U9	Percentage of food facilities labelled diverse [%]			14		VAR_9
U10	Average preference rating on coziness for the food facilities [-]			15		VAR_10
U11	Average preference rating on findability of the food facilities [-]				17	VAR_11

FIG. APP.G.1 Overview of decision variable numbers; unique numbers, decision variables numbers of the stakeholders and the numbers in the mathematical model.

Overview dates pilot studies

Overview 1st pilot interviews and workshops per stakeholder group

	Board of Directors	student council	faculty secretary	works council	pl social innovation	FMRE
first interview	19-10-2012	20-11-2012	22-11-2012	19-11-2012	14-11-2012	13-06, 2, 4-7 & 21-11-2012
pre-workshop						13-06-2012 & 04-07-2012
first workshop		28-11-2012				
second interview		3-12-2012	7-1-2013	3-12-2012	6-12-2012	5-12-2012
second workshop		23-1-2013				
third interview		18-3-2013	5-3-2013	19-2-2013	4-3-2013	20-2-2013

Overview 2nd pilot interviews and workshops per stakeholder group

	Board of Directors	Director of Education	Student council	Teachers	E&S Affairs	FMRE
first interview	19-10-2012	21-3-2013	20-11-2012	21-11-2012, 12-03-2012 & 15-04-2013	30-10 & 12&14-11-2012	20-02 & 19-04-2013
first workshop		28-3-2013	11-3-2013	22-4-2013	11-3-2013	11-3-2013
second interview		15-4-2013	20-3-2013		20-03 & 15-04-2013	19-4-2013
second workshop		2-5-2013				
third interview	18-03 & 30-5-2013	30-5-2013	29-5-2013	3-6-2013	29-5-2013	22-5-2013

Acknowledgements

After nine years of diligent work, this long and challenging PhD journey has come to an end. Doing a part-time PhD at a later stage in life has certain advantages. Having work experience and understanding the problems that CRE managers are confronted with at first hand reinforces the urgency of the problem and is a blessing. And then, having the time to study a solution in-depth is a luxury. Next to that, I have been able to do things I love at the same time. Doing a part-time PhD at a later stage in life also has some disadvantages. It was challenging to balance the diverse set of tasks and to balance the different academic languages that play a role in this thesis. It was also challenging to restart working on the thesis after been ill for a year, but the hardest was to make the PhD the most important task of all.

First and foremost, my gratitude goes to my promotors: Hans de Jonge and Jonathan Barzilai. Thank you Hans for believing in me. This would not have been possible without you. I am grateful for your guidance, patience and especially your strategic eye that brought me back to the essence of the thesis time and time again. And for your encouraging words every time I needed them and for giving me confidence. Thank you Jonathan for sharpening my mind, formulating precisely, and making me understand how you as a mathematician view the world. Thanks for the hospitality that you and Rachel gave me during my visits to Halifax.

My enthusiasm for design and decision systems was ignited, when working jointly with Peter Paul van Loon at the project for the municipality of Rotterdam. At that moment in time, I decided to a PhD. I am so grateful Peter Paul for all your support and patience, for teaching me 'to play the piano' even after your retirement. Ruud Binnekamp I thank for your support, especially when working on the pilot studies. Rein de Graaf and Peter Barendse who were always willing to support me and our graduate students when working on the mathematical models. A special thanks to the students that were fascinated by the same topic as I was: Stefan van de Schootbrugge, Bart Valks and Hylke de Visser.

I also want to thank my employer TU Delft, the Faculty of Architecture in the Built Environment and especially our department Management in the Built environment, for giving me the opportunity to work on a PhD study during my tenure as assistant professor. Hans Wamelink, Ellen van Bueren, Vincent Gruis and Hilde Remoy, thank you for enabling me to dedicate more time to finalize the PhD.

Besides my supervisors, I am grateful to Anja Stokkers from TU Delft and Randy Smith from Oracle for being able to execute the pilot studies in their organizations. And with them, all the people who participated in the PAS pilots.

Without my paranymphs, I certainly would not have made it to the end. Martine, there are no words to describe our friendship. I am so happy with you in my life. Judith, your enthusiasm and loving pragmatism is irreplaceable unique. You have been an extraordinary friend and support in these last two years. Next to that, I have been blessed with friends that supported me along the way. Jackie, thank you for reading the first drafts, Inge, my oldest friend from primary school, for proof reading the final draft, my sister Ingrid for finalizing the images and Janet for designing the cover art.

Over the years our department has been my 'work' family. Alexandra, thanks for your support whenever I needed it. We have known each other since the very beginning of MBE and since 2016, I joined the campus research team, that we have been leading together ever since and this fills me with joy. I cherish the memory of our exuberant laughter. Special thanks to the long-standing campus research team members Flavia, Bart and Malgorzata. The diversity of our team in background, culture and subjects inspires me.

Next to that, I want to thank all fellow PhD students with whom I shared - at one time or another - with pleasure the PhD +1 office as well as all current and previous members of our real estate management (REM) section. Leentje, thanks for your friendship and co-authoring my first journal paper. Chris, it has been an utmost pleasure working together and making the most out of the 24 hours each day, being on opposite sides of the globe. And thanks to all the graduate students with whom I travelled alongside for a certain time, who inspired me with their curiosity.

Life is beautiful thanks to my dear friends Martine, Janet, Ingrid, Helena, Anja, Jose, Judith, Threes, Alexandra, Nienke, Smaragda, Inge, Phae, Tulia, Gonneke, Julée and Marte. Thanks to your friendship, encouragement and trust, I have persevered and completed the PhD.

My dear PhD-three-day-writing-course-peers Hanneke, Charlotte, Sigrid, Andries and Ria (†). Thanks for all the shut-up-and-write sessions where we wrote and shared our joys and sorrows. I am proud that we have now all finished our PhDs.

I reached the beautiful age of 50 during my PhD research. Every life, and PhD process, is a bumpy ride. What shaped me most were the loss of my father Hans in 1975, my world travel and encountering breast cancer in 2015. Every day, I am grateful that I am growing older. I would be happy to add another 50. Unfortunately, in this PhD period, we have lost some family members and friends: Eric's parents Wim and Ida, my aunts Tineke and Bep, Ria as well as my dear friend Joan and very recently Alma. We laughed, cried and lived together!

My dearest mom, you've been my support for over 50 years. If needed, I'll come over and sit at your kitchen table. You listen, you nod and you ensure me it's going to be okay. You are wise, smart and modest. You've always supported me and Ingrid to study. Your adagium is: you can never own too many books and now I give you one more. How beautiful!

And last but certainly not least, my loving partner Eric and daughter Danielle. I am grateful that you have stood by my side in sickness, in health and during the PhD. Love is letting the other be, thank you Eric for letting me be. Danielle, thank you for filling my life with joy. I love you and I am so proud of you. With this thesis, I hope to inspire you to make everything you value, not defenseless, but defensible.

Curriculum vitae



In 1993 Monique was one of the first four graduate students of the Faculty of Architecture's Master track "Bouwmanagement & Vastgoedbeheer", the current department of Management in the Built Environment (MBE), at the Delft University of Technology. She graduated with distinction on 'productivity and real estate, privacy and communication in offices' at the "Rijksgebouwendienst" (Central Government Real Estate Agency). Her drive for real estate management lies in her focus on people and processes, which has guided her in her entire professional life.

She worked four years as consultant for Starke Diekstra / Arcadis and was involved in building projects in the Netherlands and the Netherlands Antilles. From 1998 to 2000 Monique was senior real estate consultant and partner of Diephuis Stevens, where she worked on projects ranging from 20 to 1000 workplaces with investments up to 50 million euros. During this period she obtained an Executive Master of Business Administration degree at TSM Business School (1998 – 2000). After working in practice for seven years, Monique travelled the world, and spent years in India, Brasil and La Gomera, Spain.

Since 2003 Monique works as assistant professor Real Estate Management for the department of Management in the Built Environment (MBE). In the beginning she combined her work as assistant professor with freelance consultancy. From 2010 she focused full time on her work at university.

Monique is a passionate teacher and loves interactive teaching. She is responsible for the BSc (Bachelor) course on briefing (350+ students) and has coordinated the Real Estate Management MSc (Master) course for many years. Monique specializes in corporate real estate alignment and divides her work in three main areas: first and foremost her work is about a design and decision approach to CRE alignment.

Her aim is to enhance CRE alignment by combining heart and head, when designing corporate real estate solutions. Next to that, she worked amongst others with Chris Heywood from the University of Melbourne on a systematic comparison of CRE alignment models in theory. Together with colleagues and graduate students she studies how CRE alignment is done in practice.

From 2013 to 2018 she was head of the real estate management section at MBE. With professor Alexandra den Heijer, Monique leads the Campus Research Team. Next to her work on CRE alignment she has focused on alignment for municipal and educational real estate. During the last 10 years she coordinated and/or participated in the think tank 'Envisioning the Faculty of the Future' (2009), Campus vision 2030 TU Delft (2010), Ownership of museum real estate (2012), Campus NL (2016), Campus tools (2017 - ongoing), European campus (2019). Monique has published more than 30 journal papers and books and received an "Outstanding paper award" for the paper Designing a preference-based accommodation strategy: A pilot study at Delft University of Technology in 2016 from the Journal of Corporate Real Estate.

Besides TU Delft Monique regards CoreNet Global as her second work family. CoreNet Global is the world's leading association for corporate real estate with more than 11.000 members. She served on the Global Board from 2015 to 2019 after being involved in the Benelux chapter board as member and chairwomen for many years. Recently, together with Jose Zwerink, Monique started the foundation We-Women-Cooperate (WWC), which strives for sustainable progress for Indian women. By connecting people, ideas & products, WWC brings affordable and sustainable energy to India, giving women room for economic development.

Corporate Real Estate alignment

a preference-based design and decision approach

Monique Arkesteijn

One of the long-standing issues in corporate real estate (CRE) management is the alignment of an organization's real estate to its corporate strategy. In the last thirty years, fourteen CRE alignment models have been developed. In these models the objective is to become 'more aligned' and in some of them the target is maximum or optimum added value. Extensive research into these models provided valuable insights into building blocks, components and variables that are needed in the alignment process. But these models fall short in two ways. Most models pay little to no attention (1) to the design of new CRE portfolios and (2) to the selection of a new CRE portfolio that adds most value to the organization.

With the development of a new approach, the Preference-based Accommodation Strategy design and decision approach (PAS), this research addresses the deficiencies of previous alignment models that either place too much emphasis on financial measures or lack clarity in decision making due to the difficulties of quantifying the intangible and subjective. The main research question is:

How can the PAS design and decision approach successfully be developed and used on corporate real estate portfolio level in order to enhance CRE alignment?

The originality of this research lies in two main novelties. Firstly, by defining value as technically equivalent to preference. Secondly, by using a design and decision approach for the alignment problem. The applied Preference-Based Design procedure enables stakeholders to design and select alternative CRE portfolios. By doing so, stakeholders are able to determine the added value of new CRE portfolios. PAS is tested successfully and evaluated positively in three pilot studies.