

Anne Lacaton

+

Heritage & Architecture

x

Dwelling

x

Building Technology

x

Management

x

Methods & Analysis

Contents

Introduction 5

Wessel de Jonge

Statement on Reuse 6

Anne Lacaton

Heritage meets Dwelling 9

Lidwine Spoormans

Heritage meets Building Technology 19

Lidwine Spoormans

Heritage meets Management 31

Lidy Meijers

Heritage meets Methods & Analysis 39

Alexander de Ridder

Acknowledgements 49



Introduction

-

Wessel De Jonge

Anne Lacaton has been a visiting professor at the TU Delft Faculty of Architecture and the Built Environment during the Fall Semester 2016-2017, hosted by the Chair of Heritage & Design. In the professional field of Heritage & Design the starting point for design is not just a functional brief and a blank sheet of paper but the challenge of an existing spatial setting and cultural-historical context. It is a dynamic and innovative field in architecture that deals with the architectural re-interpretation, adaptive reuse and restoration of historic buildings.

Anne Lacaton is one of the founding partners of Lacaton & Vassal architectes in Paris, which is known for their accurate analysis, architecture of modesty and societal engagement. Among their better-known projects are the Palais de Tokyo in Paris, the FRAC in Dunkerque and the transformation of the Tour Bois le Prêtre housing block in Paris. Over the last decade they developed a smart and integrated approach to revitalise existing buildings through adaptive reuse. Holding true to her credo 'Transform, add, re-use, never demolish!'

she puts the building's user, use and re-use first, resulting in modest projects that make a difference for its dwellers and context. The program kicked off with a retrospective exhibition on the works of Lacaton & Vassal curated at the occasion of the 2016 Heinrich Tessenow Gold Medal Award.

Lacaton's visiting professors' program has included education, research and public activities. She has been co-leading a MSc1 and a MSc3 studio, and has been involved in on-going research projects on recent Dutch museum buildings and on housing refurbishment. The office Lacaton & Vassal and the hosting chair Heritage & Design share a strong basis in analysis of the existing and both advocate an integrated design approach. In this visiting professors' program 'Heritage' was linked to other fields in architecture in order to share knowledge, exchange visions and to find common ground. The significance of heritage for contemporary society and the relationships with other fields have been central themes of the program. The chosen interdisciplinary format for the workshop series, events and public lectures has therefore been instrumental.

We thank Anne Lacaton for having her at our faculty and sharing her knowledge and inspiration. It has been a great pleasure for students and staff alike. We all hope she'll be back soon!

On Reuse

-

Anne Lacaton

Continue the story, re use, re invent, re compose, cling, graft, extend : the way of future, a new intelligence for architecture

In the workshops and studios, we have worked on re-use projects at different scales, in different situations and with different programs.

These projects generated reflection along with pertinent and inventive ideas that made it possible to overturn the situations in a positive manner, to change the approach and bring forth interesting solutions, a new situational intelligence and a new intelligence towards thinking about architecture and the urban situation.

In these projects, what is initially seen as obsolete and as a constraint or restriction through an opening of the mind and a change in outlook and approach, becomes an opportunity, a chance and an asset.

If you look at a situation without a frame or filter and with an open spirit, a building that no longer has purpose and is a hindrance becomes a liberty.

The students adhered to this specific approach:

No longer looking at something existing as imperfect, constraining, obsolete, not beautiful etc., but instead as a resource, a component, a stratum/layer and a basis for creativity.

The idea of drawing value from everything existing, producing richness with less money but with the greater means and parameters offered by existing situations. Extending the story to do better and more of it. A process of regeneration, extension, adaption and re-use rather than replacement.

This way of seeing, thinking, projecting is not really widespread. Making new, remove and replace, restarting from the empty remains mostly the way of doing; whereas the superposition, addition, combination, overlapping, infiltration, appear accurate, contemporary, rich, innovative.

Therefore, with regard to this work of the semester and to conclude the guest invitation, I think it's important to collect and publish these ideas and positions by students and teachers involved with the semester's work.

We hope that this booklet will leave a trace and a lasting material for reflection and discussion.



ART EST SIMPLEMENT
LA PRÉVUE D'UNE VIE
LEINEMENT SÉCURE
DU 2000 3 JUN 1998

Heritage >

« Dwelling



Redesign the Floor Plan

In the first of the series of interdisciplinary workshops in the visiting professor program of Anne Lacaton, students have made redesigns for existing apartments in order to study dwelling typologies, develop a vision on quality of living, find new notions of quality and design a good plan.

During two days they worked in teams on the assignment, produced their redesign based on a set case and brief and present it by a fixed format.

Teams of 2 or 3 students (mix heritage-dwelling) collectively worked on one case. They studied the plan and analysed existing and missing qualities. Subsequently they designed an improved plan. General points of attention were:

- Size of the apartment
- Size, position, layout of bathroom, toilet, kitchen
- Size, position, quality of outdoor space
- Size, layout, quality of living room
- Daylight
- Quality of transitions between inside and outside
- Relation between rooms
- Entrance and routing

All teams worked with the following set of design rules:

- Changes should have a clear reason and an improved result
- Extensions are allowed (if for a good reason and result)
- Merging apartments is allowed (if for a good reason and result)
- Load bearing structure and shafts stays unchanged

Students worked on several generic housing typologies, that have been built in The Netherlands in the postwar period. These multi-story apartment blocks generally are not perceived as high quality housing. But the vast amount, the inhabited state and the need for a circular economy make renovation very relevant.

When studying these typologies, students discovered some elements of good quality and developed designs that use these qualities in a new context or use.

The Intervam building system is a post-war housing system of prefab concrete slabs, developed in the 1950's and 1960's. The design case in this workshop is a single-oriented apartment that stretches along the façade. The full width of the apartment can't be experienced because the apartment is rigidly divided in three parts by two load-bearing walls.

The Elvira flat was designed in 1960 by architects Van den Broek and Bakema. Opposite to most of the system-flats developed at that time, this building is based on split levels, where communal corridor occurs only every three floors. The spatial quality of this split level however, is not experienced in the present situation.

The apartment type 'Algemeen Belang', designed in 1940, was a repeated block that was implemented over several sites all over Rotterdam in prewar and postwar years. The design is by architect Van den Broek and is an example of 'the existenz minimum', an efficient and optimised plan and building system. As in many modern housing estates the urban space and garden are large and green, which is an opportunity.

Intervam

Batista Lopes

Niels Timmer

Yuan Chen

The ambition we had for this apartment was to create some kind of enfilade, a common feature in architecture from the Baroque period. Rooms are formally aligned with each other. The openings to enter each room are aligned along a single axis, providing a view through the entire suite of rooms. A nice side-effect is that circulation space is incorporated in the rooms. The apartment keeps its quality of rigid division in three different rooms, the full width can be experienced and the living spaces can be bigger and feel more spacious because of the view through the openings provide through the entire apartment.





Elvira Apartments

Roel Kusters

Jan Ksiazek

Zheng Xiangyu

In our design open stairs become the leading element inside the dwelling. Vertical movement creates transition between spaces rather than the former sequence of 'leaving room'-'stair'-'entering room'. New quality of overlooking the living room from the kitchen enriches the spatial experience of the users. Unique existing layout of the flat makes it possible to link two parts situated above each other into double height apartment. This intervention emphasises the openness and common space in the apartment. It also brings an opportunity for external extension to accommodate more residents.



Flexible layout,
possible extensions
and additional communication
(easy to assemble spiral staircase)

Double height and
visual connection between spaces

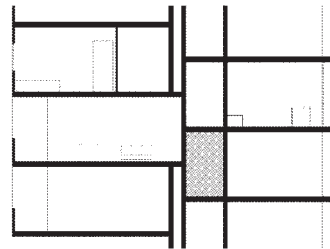
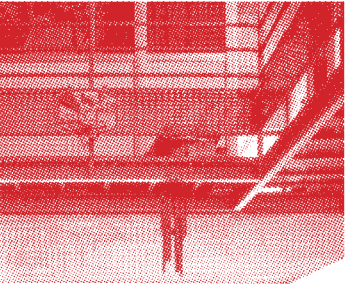

Existing

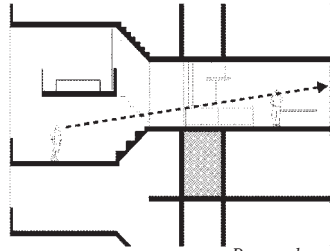

Proposed

OPEN STAIRCASE REDEFINES THE APARTMENT

apartment,
between spaces

Open gathering space,
missing in the existing apartment

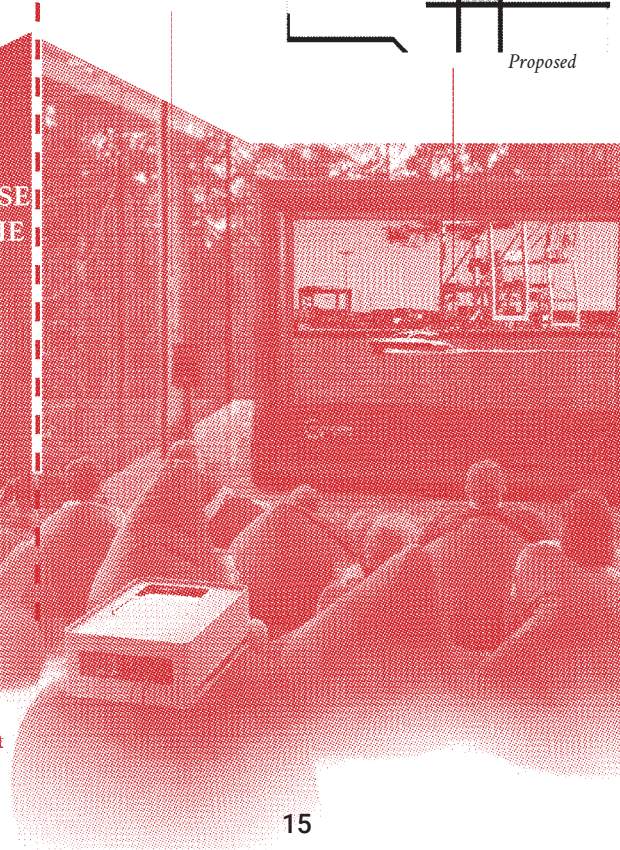

Algemeen Belang

Bronya Meredith

Josh Stevenson

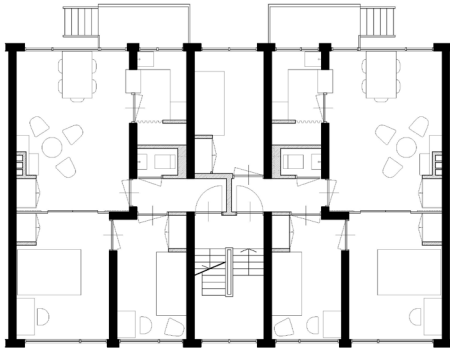

Existing Floor Plan



Proposed T02

The repeated plan in the existing situation offers only two variations in apartment layouts.

The plans were designed to allow maximum flexibility in orientation by allow for the staircase and third bedroom to swap position depending on the orientation. This means that sometimes balconies overlook the garden but sometimes they overlook the street, meaning that extending outwards is not always an option.

We were interested in looking at updating the plan to offer a variety of apartments for different households. Furthermore we intend to relate apartments to a collective garden by balconies and stairs and to create new collective satellite spaces surrounded by trees.

Image showing improved relation between apartment and garden, by enlarged balconies and satellite spaces in the vast collective garden

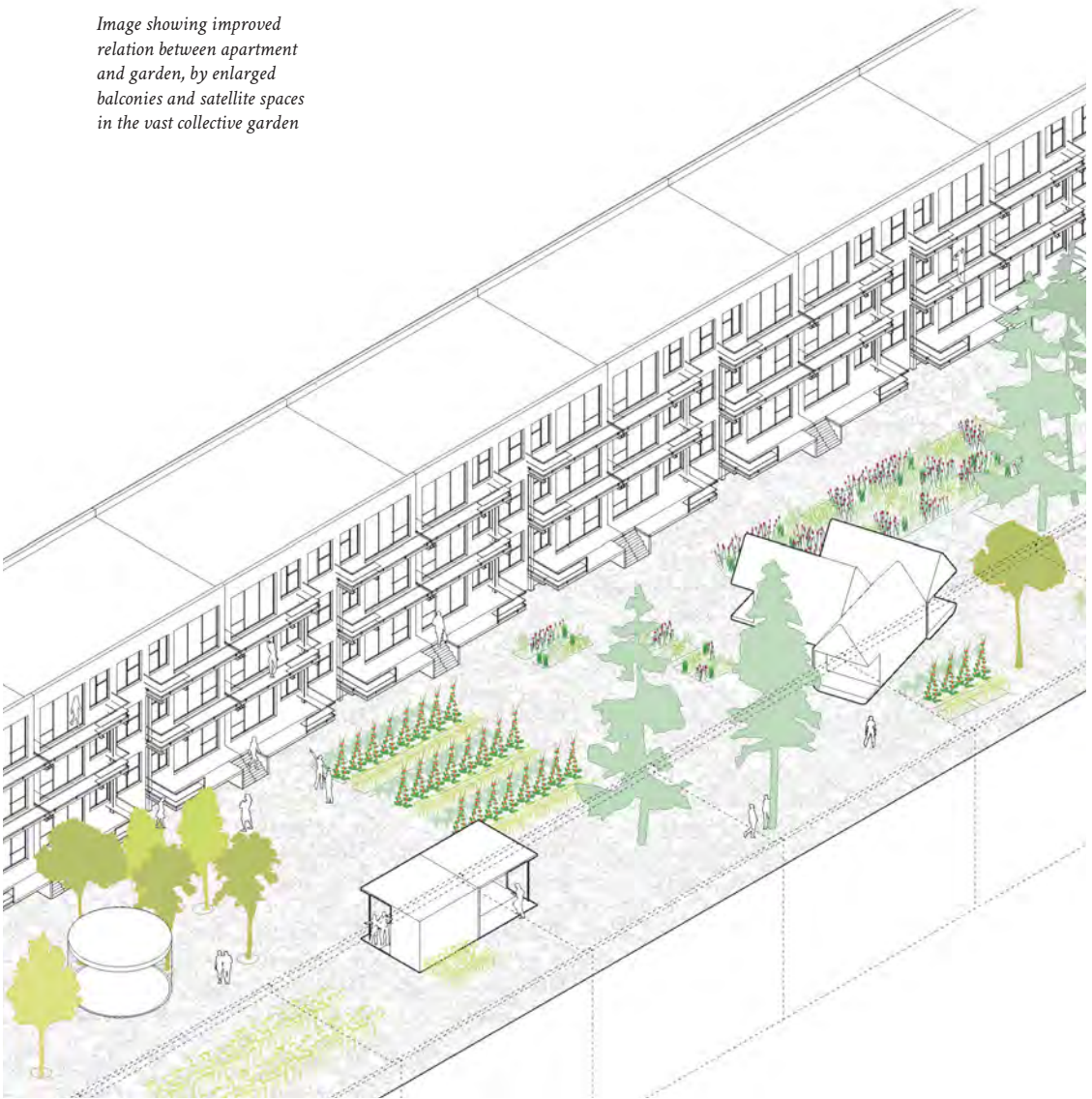

Heritage >

<

Building Technology

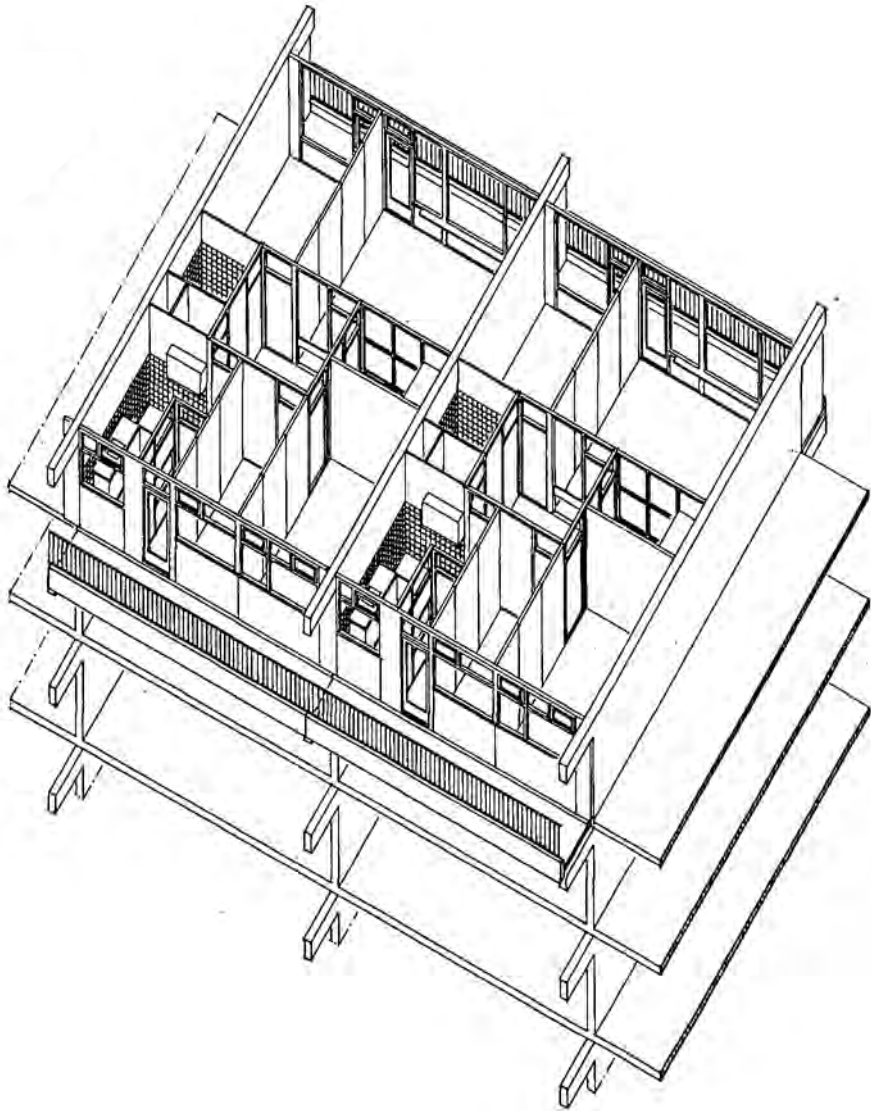

Redesign the Facade

In this workshop students make a redesign for the facade of existing apartments, based on the redesigned floor plans of the first workshop 'Heritage meets Dwelling'. Students study the many functions of the facade, its limits and opportunities, to make an integral design and to develop a vision on what a good facade-zone should do for living quality in all its aspects.

Design rules are:

- Redesigned floor plan is the starting point
- New facade design should improve the total quality and functioning of the dwelling
- New facade should support (and improve) the conceptual idea of the redesign

All new facade designs should address the following aspects:

- Energy efficiency
- Use and functions of facade and rooms
- Spatial quality
- Outdoor space
- Daylight
- Construction possibilities
- Aesthetic expression
- Heritage value and image

Possible strategies are improving the existing facade, replacing by a new facade or adding extra layers. Developing concepts for facades renovation addresses the very relevant theme of energy performance and sustainability.

Intervam

Rick Hoofd

Ruben van den Boom

Aims for our design:

1. Eliminating visual barriers between front and back by deleting interior separation walls
2. Bring natural daylight to the living space by creating voids
3. Connecting garden with interior by extended balconies with planters

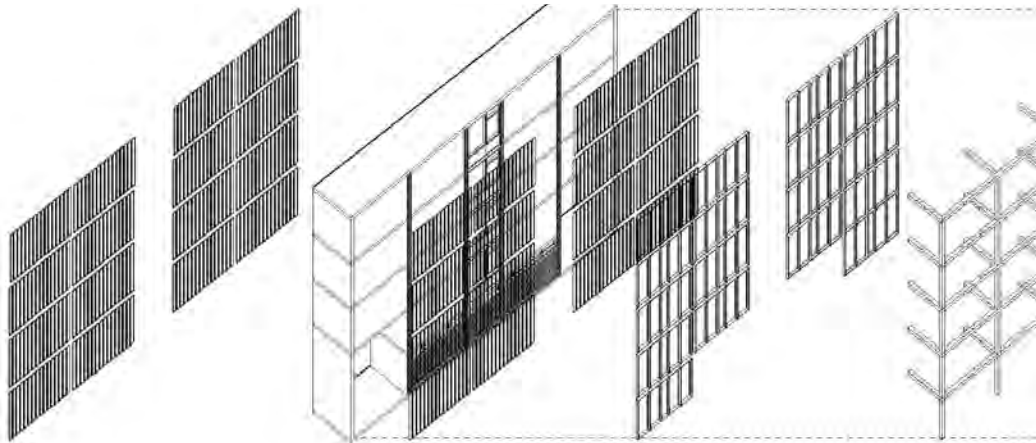
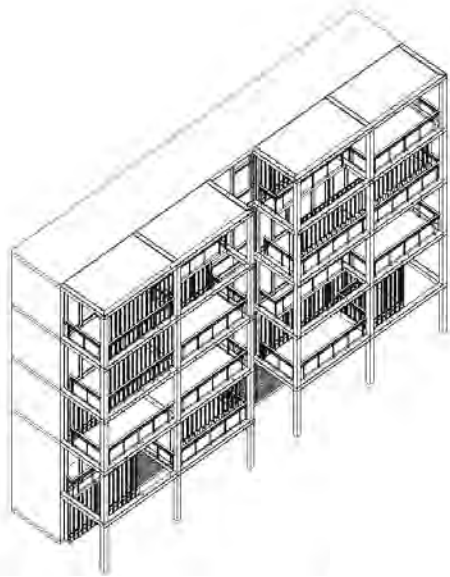

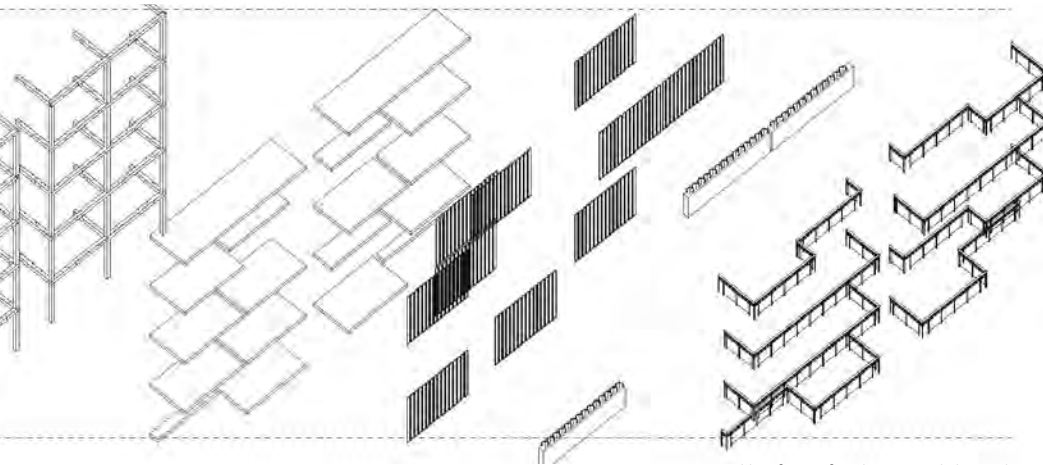

Assembly of: new facade: internal thermal screen, old structure, personalized curtain, new glazing, new external structure, extended balcony space, screen, planters, railing

Algemeen Belang

Yonghui Huang

Chi Teng

Yuan Chen

The façade-design expresses the different floor plans, creating variance of the skin while keeping the original rhythm of symmetry. Fragments, including boxing windows and balconies, strengthen connections between inside and outside. Landings are extended as a communication space, making full use of the feeling of transparency and openness in the glazed stairwell. Another ambition of the skin is to achieve better energy efficiency and better indoor climate.

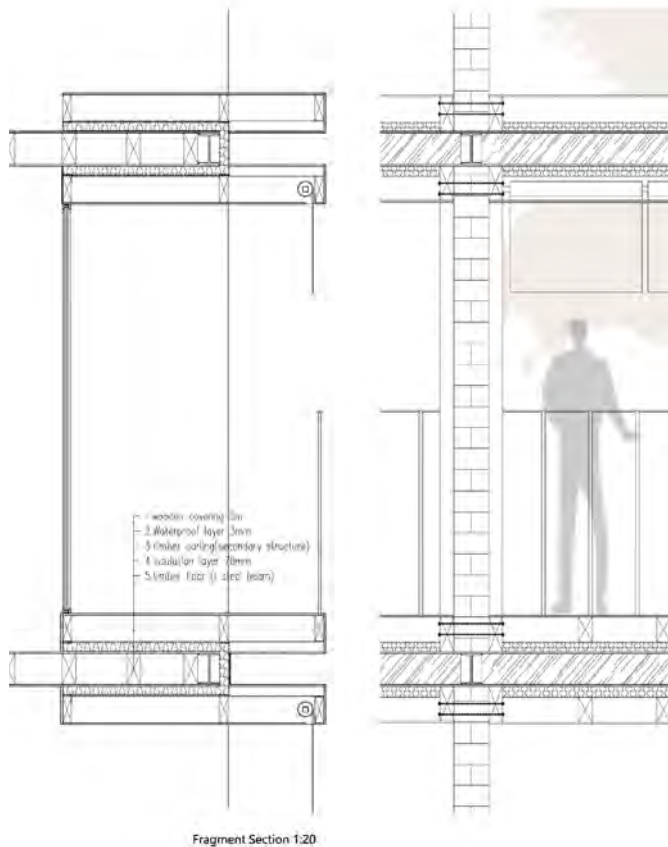



Algemeen Belang

Yonghui Huang

Chi Teng

Yuan Chen

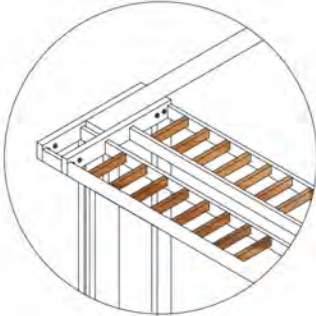
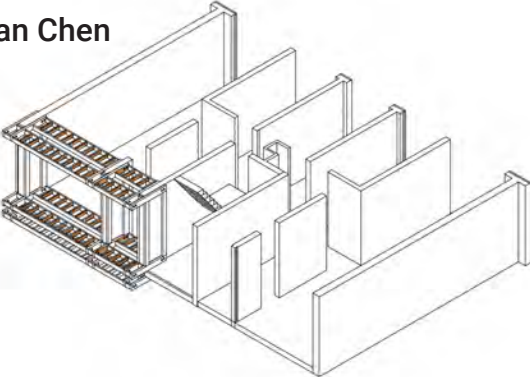

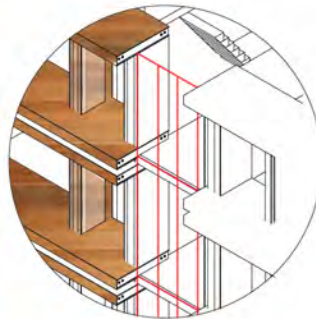
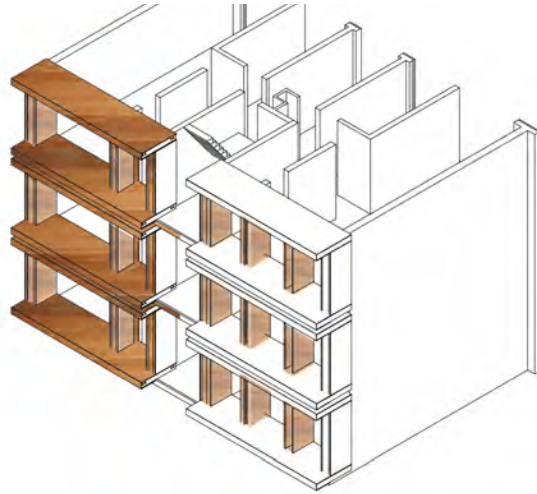
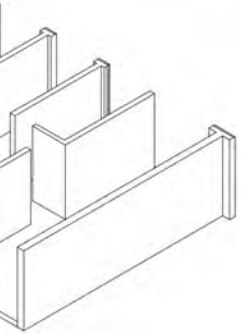

Construction process:

- 1: remove existing wall*
- 2: attach wooden beams to masonry load bearing wall*
- 3: supporting beams*
- 4: add purlins*
- 5: wooden exterior cover*
- 6: renovation of existing staircase window frame, adding double glazing*

Algemeen Belang

Andrea Gentilini

Jeroen Haers

Observations:

1. Courtyard is a big quality but not usable for everyone
2. Poor thermal comfort
3. Privacy issue in transition private to public space

Design solutions:

1. Bring the green up to enlarge and improve living space
2. New insulating skin as an extension towards courtyard creates more thermal comfort and extra space
3. Extended green facade creates a gradual transition from private to public space.

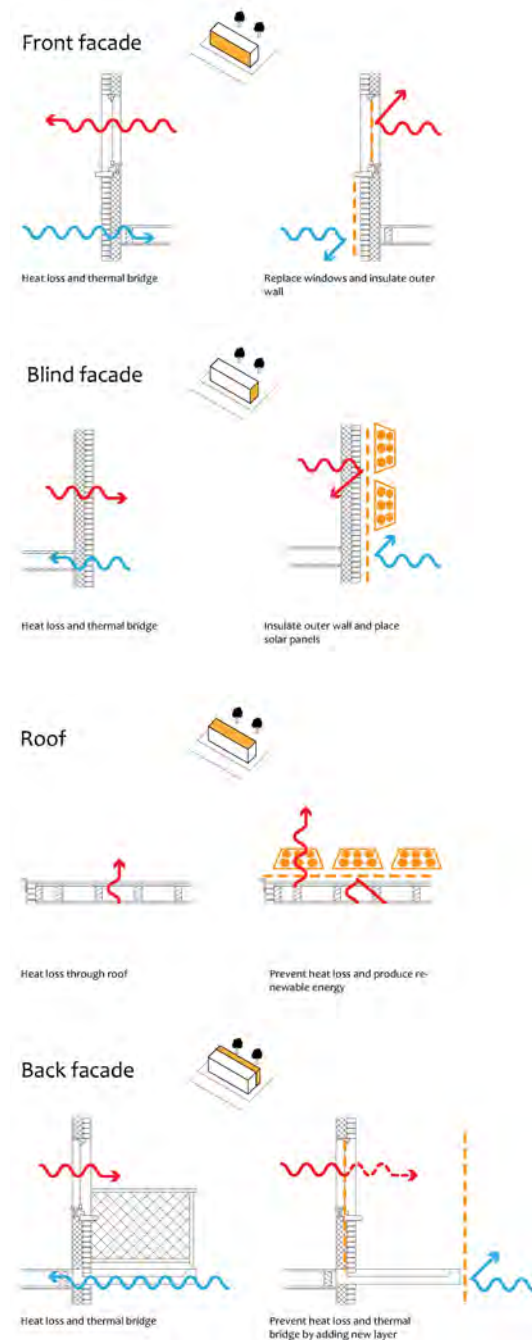

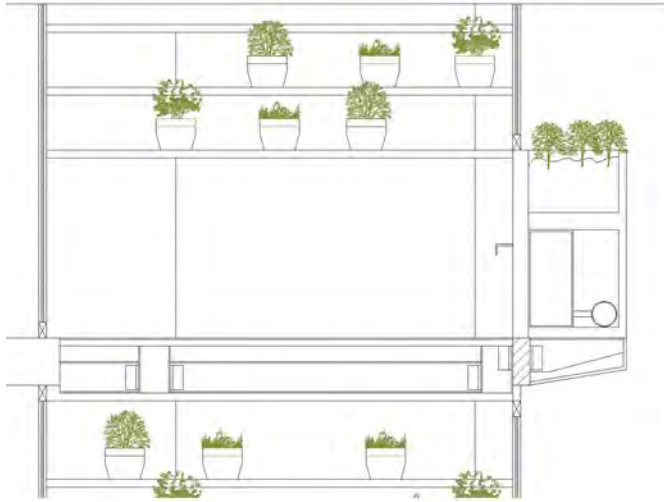
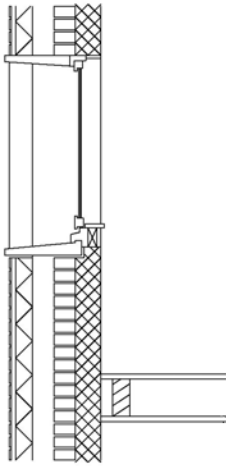
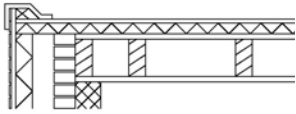

Heritage >

Management



Surplus Value

The workshop concentrates on a design strategy of a case study that can increase the economical values of the property. The strategy in a case study for the surplus value, in a leftover space or an opportunity of the changing context, can have a meaning for different aspects and for effective reuse.

Context:

Monuments, buildings and areas of re-development (revitalisation) are registered for a certain value financially. Various aspects of the built environment are important for setting or qualifying the future value of a transformation.

Aspects for qualifying the future value have a specific character per building. The weighing of different aspects depends on many tangible and intangible aspects; social circumstances, cultural historical interpretation, the neighbourhood and location, social welfare and public interest, energy consumption, and so on.

The question is how do you determine this future value of a transformation design? Is it possible to express this value into balance sheet value, or into another value?

What is the choice or hierarchy of the value areas based on? These aspects may have

conflicts, or chances in relation to time. Time is a parameter that can be used for different pace of the transformation process.

Perhaps it is a play of values that leads to different outcomes, or maybe is there a determinant? Is it like in a mathematical matrix with different parameters or is it a convincing reasoning?

Assignment:

Determine the strategy of a redesign of a building is the assignment. In the workshop Heritage meets MBE certain values will be discussed in teams from the point of view of the own discipline (Arch-MBE or other). Decide and determine the surplus value, the adding values/added value, of the monument/area, in terms of hard / soft "currency" and/or other values of interventions in the existing. What is the value in the short term, medium term and long term?

The former station of Delft of architect C.B. Posthumus Meyjes and the faculty building of TNW of architect Dirk Roosenburg as case studies give opportunities to explore these two different types of buildings for strategies. In several products the outcome will be presented; text, schemes, sketches and drawings.

TU Delft Welfare Hotel

Charlotte de Boon

Gustav Kjær Vad Nielsen

Bart Kuipéri

Sven ter Veer



The faculty of TNW at the campus has 4 courtyards that open towards the east side. The strategy of this group intervenes in the existing building. By opening the basement to the courtyards the biggest spatial impact is established. The basement and ground floor connect to the surroundings in a gentle way. The other options improve and use the existing elements and spaces of the building design of Roosenburg by visual. The lecture hall along the connecting bridge increases the functional use. The design research leads to these 4 interventions that are already latent and put an increase of values forward.

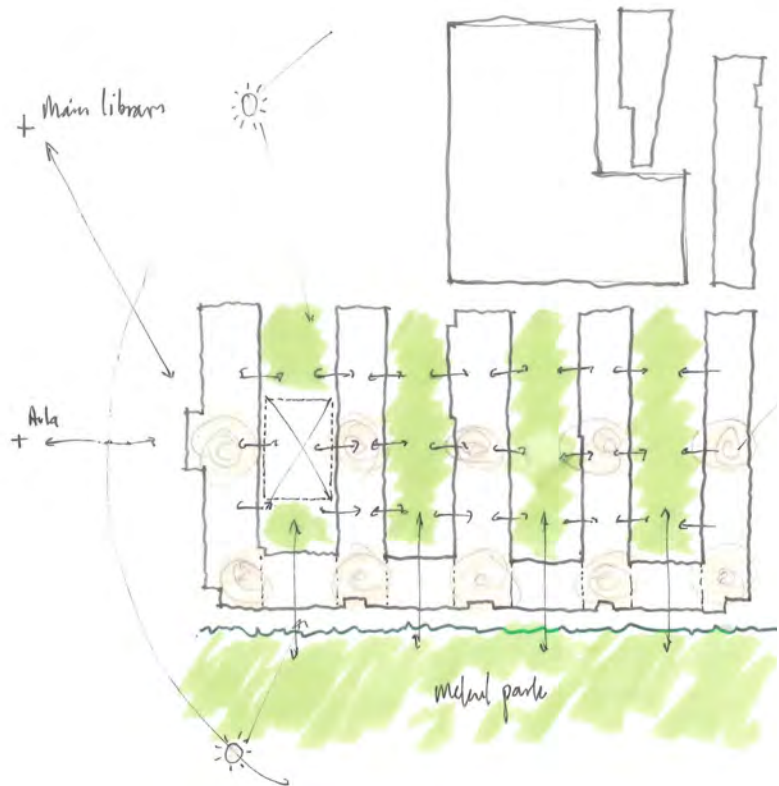

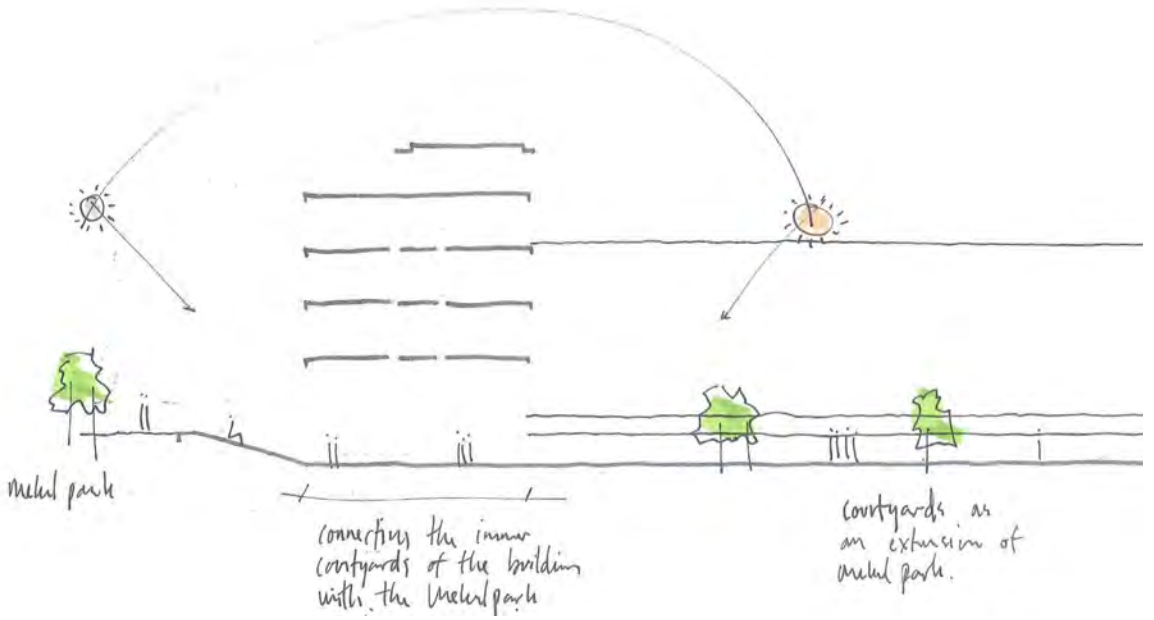
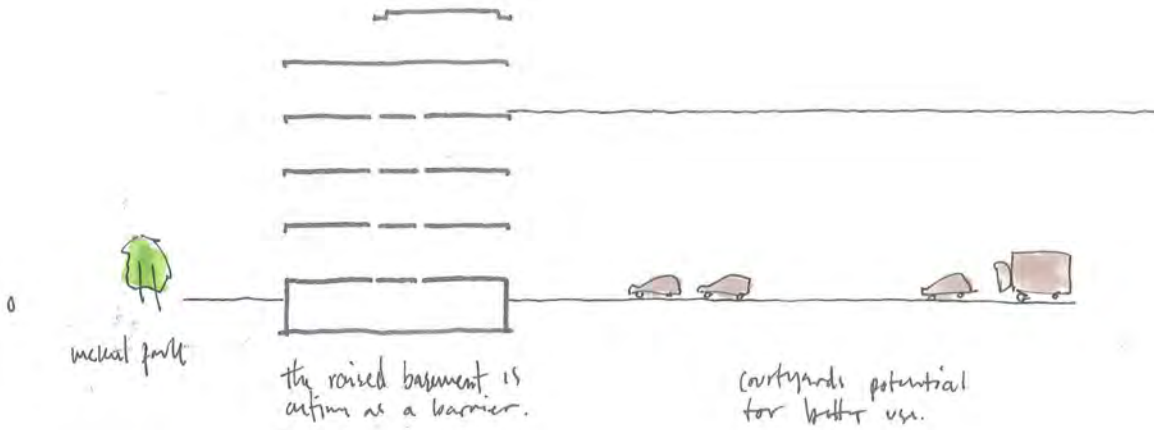

Delft Station

Anne Wil

Sofie Angelie Hovgaard

Alexia Ntella

LIGHT

One of the conclusions of the analysis of the former station building in Delft gives a clear view on the former platform side; it has become a front side since the new development around it. The visibility and accessibility present the place-making of this building in the changing context in a functional way. The bakery, market and restaurant give the building and context a vivid character during the day and night. Additional light puts the focus on the architecture of the building. The potential of the building is unlocked on all scale levels; added value!



Values

Functional | Elevated floor

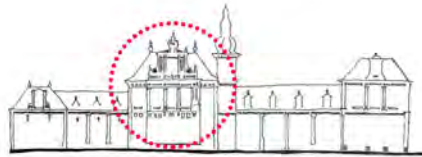

Aesthetical | Ornamentation

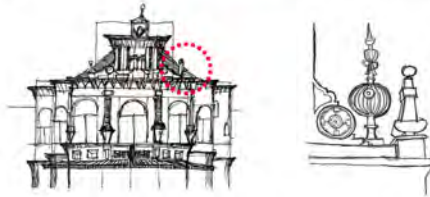

| Variety



Historical | Typology

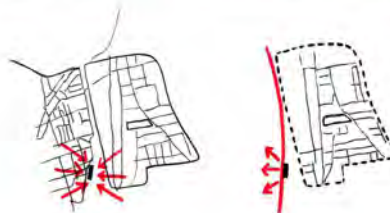

Social | Setting

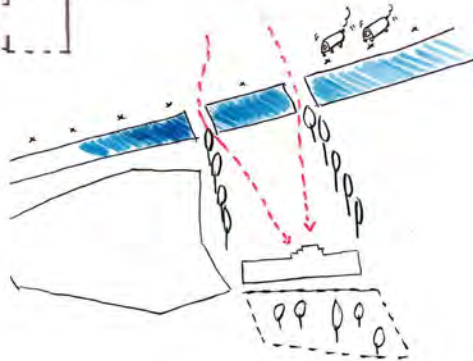
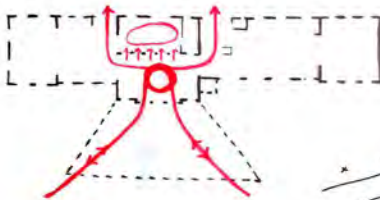
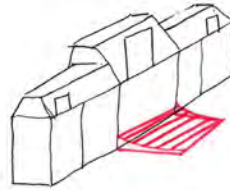
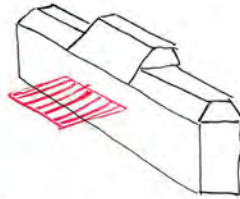
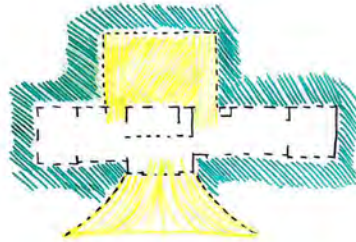

Heritage >

Methods & Analysis



Analysis of Buildings

CONTEXT	+ Historical
	+ Social
	+ Political
	+ Economical
	+ Urban
	+ Architectural
DESIGN	+ Environmental
	+ As Monument
	+ Functions and use
	+ Frequency of visitors
	+ Style
	+ Typology
	+ Composition
	+ Facades
	+ Entrance
	+ Spaces
	+ Circulations
	+ Exhibitions
TECHNOLOGY	+ Atmospheres
	+ Light
	+ Colors
	+ Sounds
	+ Smell
	+ Orientation
	+ Elements
	+ Bridge
	+ Boxes
	+ Walls
	+ Doors
	+ Windows
	+ Floors
	+ Stair cases
+ Ceilings	
+ Corners	
+ Materials	
+ Exceptions	
+ Structure	
+ Grid	
+ Module	
+ Systems	
+ Lighting	
+ Heating/ cooling	
+ Ventilation	
+ Piping	
+ Insulation	
+ Fire safety	
+ Access security	
+ Facilities	
+ Sustainability	
+ Energy	
+ Branding	

The understanding of a specific building and its context is a pre-condition for any intervention to it. The process of understanding starts with an observation and an assessment of the existing. Different ways or methods of mapping are used to record these observations. The purpose of this workshop was to explore methods of 'mapping' that could be beneficial for the process of an intervention.

The Gemeente Museum Den Haag, a museum designed by Berlage was the site of this investigation. At the introduction Anne Lacaton emphasized the importance of making an inventory of the existing situation. In the conversation with Tom Avermaete who asked if there should be any specific subjects to focus on in the process of analysing she did not make any constraint but underlined the idea of opening your senses and mind to the maximum.

Although in the invitation letter from the H&A department it was mentioned that key-concepts for mapping were time, sensitivity, spatial experience and emotion, at the brief of the workshop Anne Lacaton left the students without any specific instruction, encouraging them to be open to what they saw. The illustrations printed in this booklet about the museum made by the students proofed they had no difficulty in mapping their experience.

Gemeentemuseum Den Haag

Yonghui Huang

Chi Teng

Yuan Chen

Yağız Söylev



The drawing elucidates different experiences of the museum. Like a portrait of Picasso where you see the face and the profile simultaneously. In this illustration perspectives, sections, floor plans and elevations are unified in one image. This evokes a dynamic impression. The trained eye of an architect recognizes the sequence of spaces and the circulation path. The strong axis of the linear gallery, the 90 degrees movement towards the monumental entrance hall where

the articulated parapet of the stair cases leads the eye to the upper floors. Smoothly the route continues in an assembly of planes, vistas and circulation zones. It looks like if there is no hierarchy in the composition. Although the recently covered courtyard is situated in the heart of the building, and it became an anchor point, the labyrinth of spaces makes it hard to orientate yourself in the museum. It is always a challenge to continue your way.

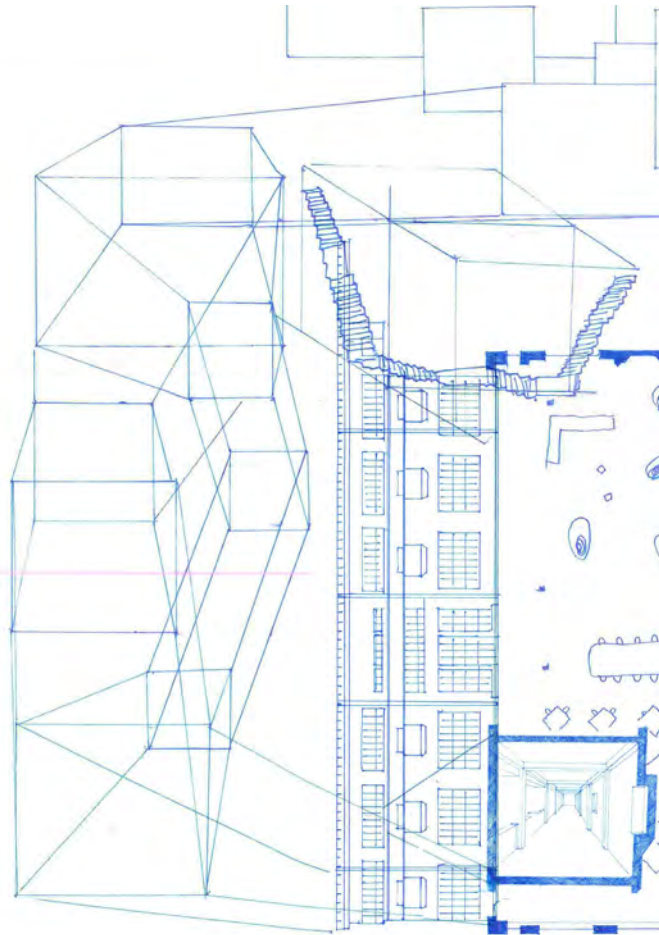

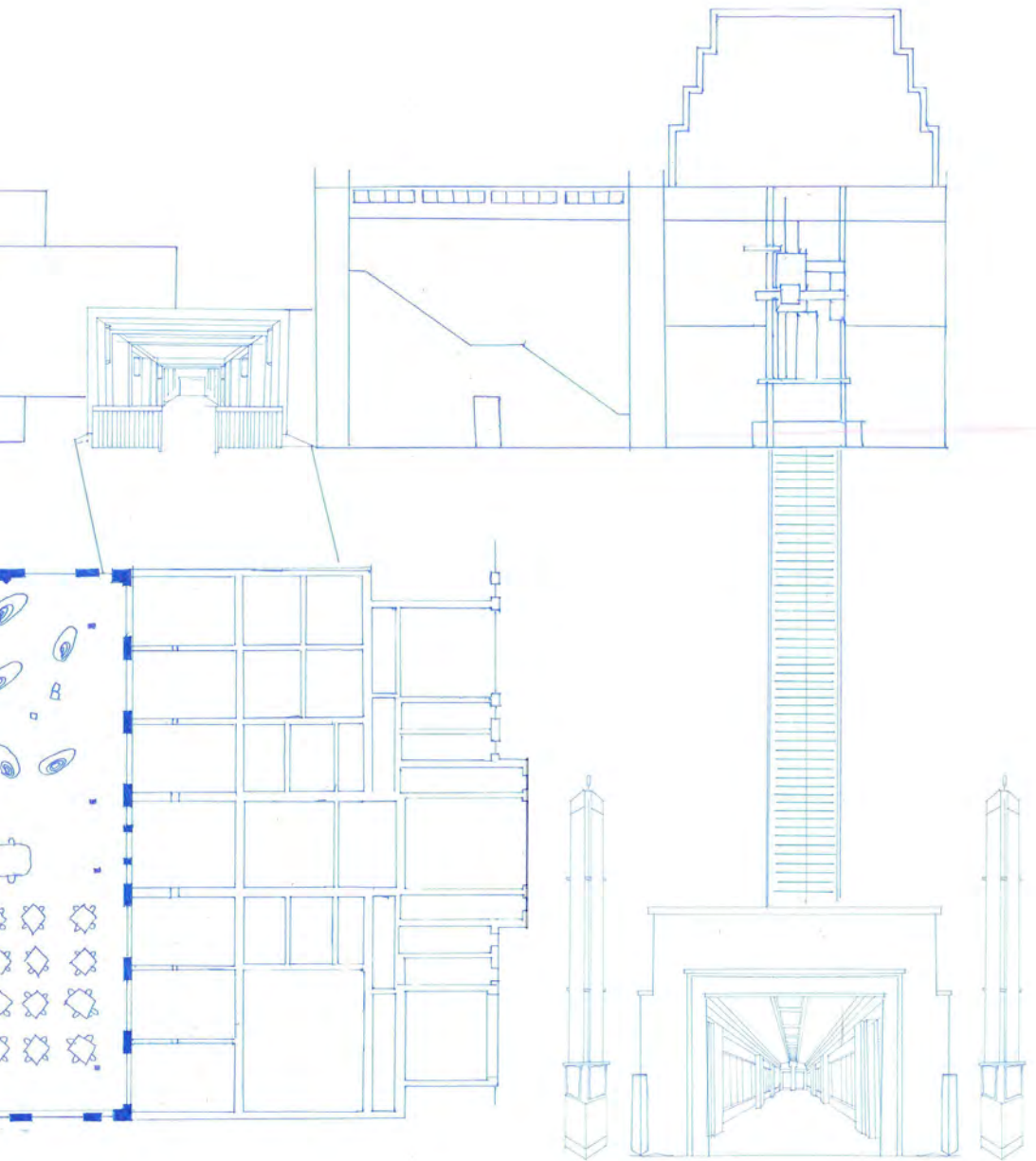

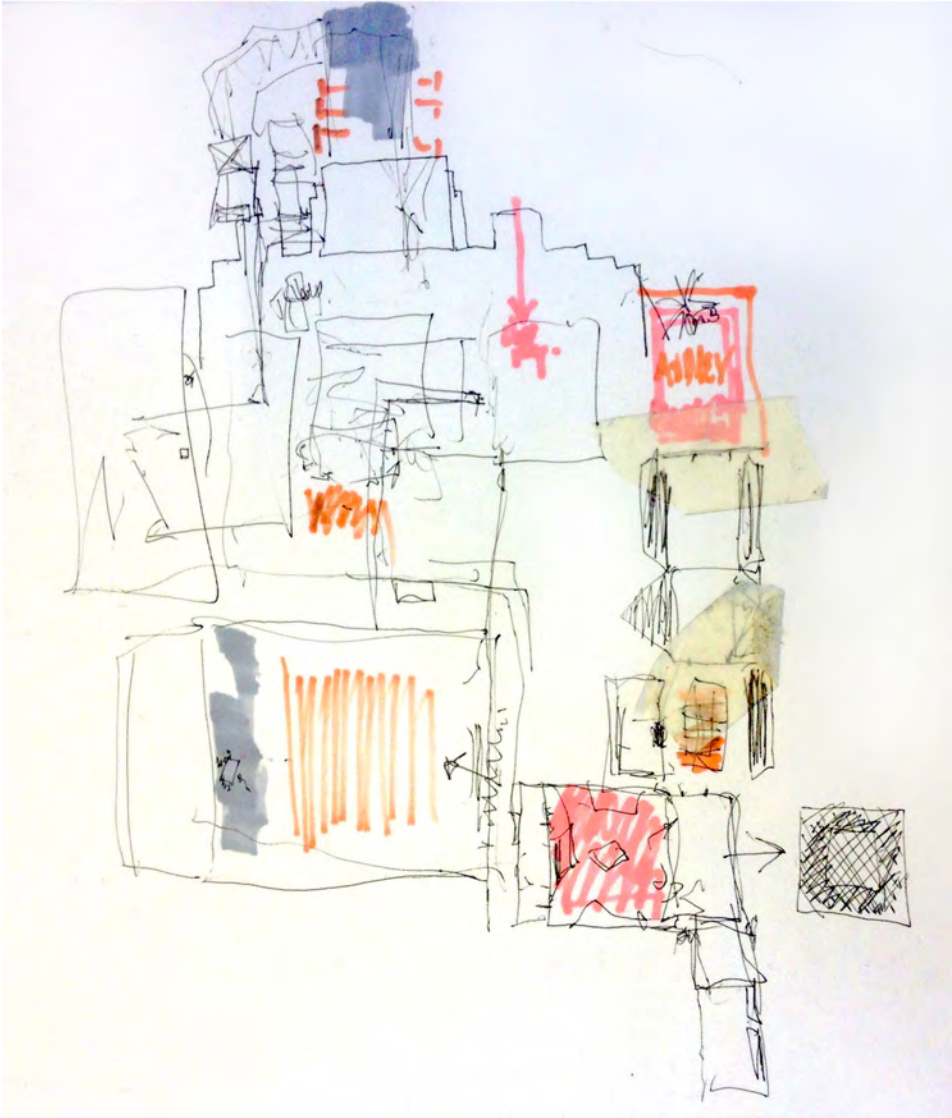

Exploring the threshold

One important aspect of designing an architectural composition is the designing of transition zones. The ultimate symbol of the transition zone is the threshold. This group investigated how in the museum the imaginary threshold between different spaces has been designed. The different sizes of the openings in the walls define the character of the transition between two worlds.

Jazmin Charalambous

Livia del Conte

Turker Saylan

Giulio digiuseppe

Simme Bruinsma



Gemeentemuseum Den Haag

Bianca Eriksson

Kevin Mazanek

Virginia Santilli

Josh Stevenson

The focus is on sight lines between different rooms and the underlying regularity that defines the order of the connection created by the sight lines. Emphasized in the illustrations is the orthogonal system of the walls by which the rooms are created. What is specific is the order of the connection. When the eye is looking from one room to another room an extra experience is offered to the visitor : they are not bounded only by the strictness of the orthogonal character of the spaces but a new order is created by the diagonal positioning of the openings in the walls.

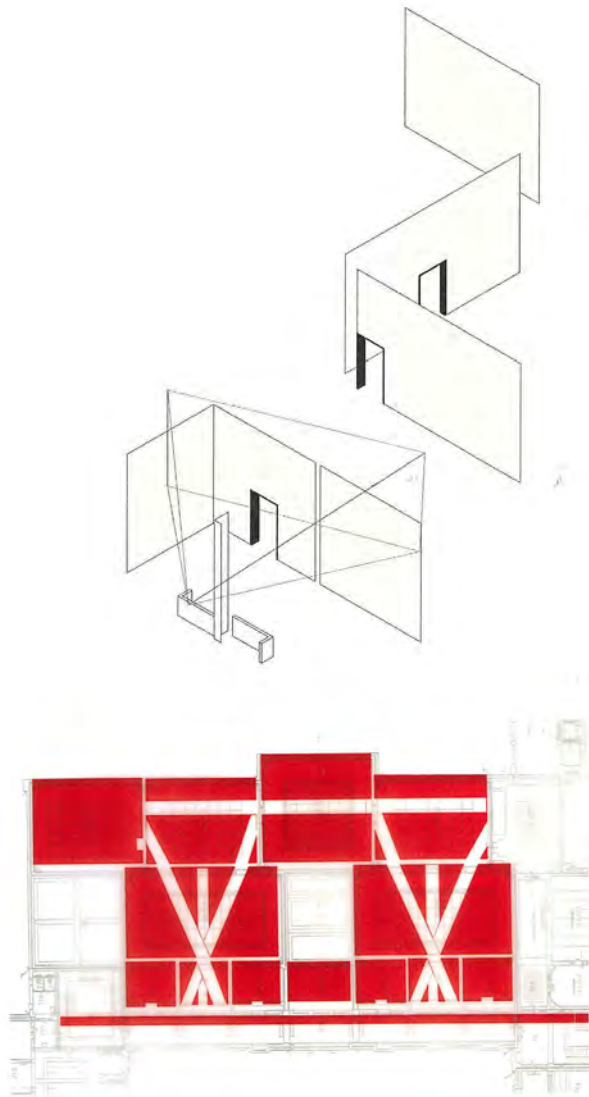



Wieringstraat 87-89 (1642), Amsterdam

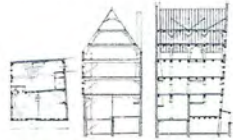

52 Achterburgwal 14 (1683), Amsterdam



1600-1650



End 1600

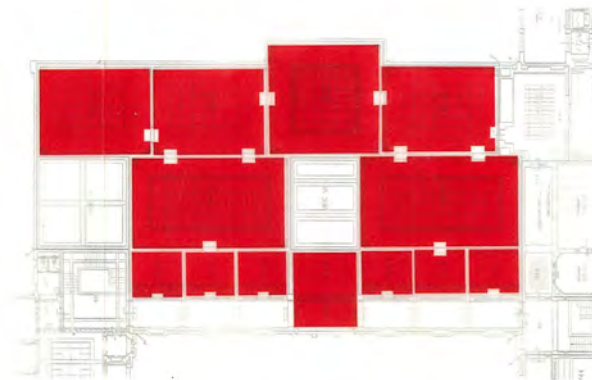

Image credits

page 7 : Frac Dunkerque, France, Lacaton&Vassal, photo Philippe Ruault

page 32 : Transformation of housing blocks, Bordeaux, Lacaton&Vassal, Druot, Hutin, montage, photos Philippe Ruault

page 40 : Palais de Tokyo, Paris, Lacaton&Vassal, plan of project

Acknowledgements:

Visiting Professor: Anne Lacaton

Hosting Chair: Heritage & Architecture: Prof. Wessel de Jonge, Lidwine Spoormans.

Faculty organisation: Prof. Peter Russell, Inge Pit, Linda van Keeken.

Exhibition: Heinrich-Tessenow-Gesellschaft: Theodor Boll and Juergen Rustler.

Dwelling Workshop

Staff: Prof. Dick van Gameren, Pierijn van der Putt, Piero Medici, Leo Oorschot, .

Students: Heejin Chung Hyung-Ju Seo Jan Książek Rick Hoofd Dimitrios Papatheodorou Simone Schade Yuan Chen Eva Fuehrer Chi Teng Xiaoyu Chen Ruben Kaipatty Xiangyu Zheng Flora Bello Milanez Celine Mugica Anna M. Grundmann Adrian Richter Bronya Meredith João Baptista Gaspar Lopes Jannik Weisser Danielle Verweij Josh Stevenson-Brown Michelle Bettman Alexia Ntella Matthijs van Mulligen Mabel Zertuche Garza.

Technology Workshop

Staff: Prof. Thijs Asselbergs, Tillmann Klein, Tjalling Homans, Thaleia Konstantinou, Robert Célaire, Frank Koopmans

Students: Heejin Chung Xiaoyu Chen Iris Snijders Blok Hyung-Ju Seo Niels Buring Yonghui Huang Yuan Chen Chi Teng Jeroen Haers Andrea Gentilini Vasileios Chanis Özhan Topcu Xiaoyu Xu Ruben van den Boom Rick Hoofd.

Management & The Built Environment Workshop

Staff: Hilde Remoy. Lidy Meijers.

Students: Andi Belulaj Rosan Pallada Livio Spada Mark van Os Judith Wolswinkel Harald Bjoerkum Hester Stuivenberg Gwenhwyfar Spil Diana Schmiljkovic Chieh-Hsin Cheng Bart Kuiperi Sven ter Veer Gustav Kjær Vad Nielsen Charlotte de Boon Anne Wil Sofie Angelie Hovgaard Alexia Ntella Giel Leunissen Lieske Senden Sicha Chittavanich Merel Bijkerk Bram Bronswijk Jelmer van der Poel Lukas Jespers.

Methods & Analysis Workshop

Staff: Prof. Tom Avermaete, Willemijn Wilms Floet, Piero Medici, Job Roos, Alexander de Ridder.

Students: Virginia Santilli Bianca Eriksson Miguel van den Berge Kevin Mazanek Josh Stevenson-Brown Jazmin Charalambous Livia del Conte Giulio Di Giuseppe Simme Bruinsma Türker Naci Şaylan Joanna Kosowicz Krist van Herck Benjamin Summers Yagiz Soylev Claire Bazeley Bronya Meredith Max Gelibter Benjamin Graber

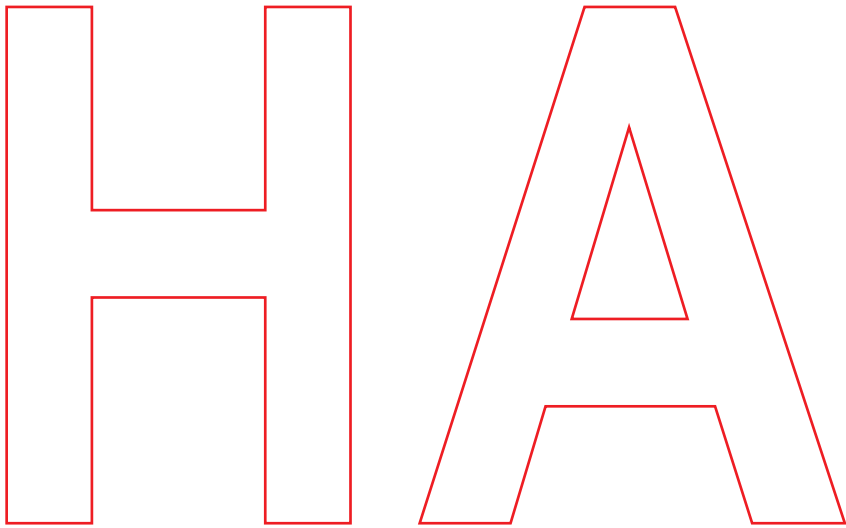
The logo consists of the letters 'H' and 'A' rendered in a red outline style. The 'H' is a simple, blocky font with a horizontal bar connecting the two vertical stems. The 'A' is a tall, narrow font with a triangular cutout in the center and a horizontal bar near the base. The entire logo is contained within a red rectangular border.

H A

HERITAGE & ARCHITECTURE