

Designing from Heritage

Strategies for Conservation and Conversion

Marieke Kuipers
Wessel de Jonge

3

^	3	5	3
2			4
1 0			

Designing from Heritage

This publication was made possible thanks to the support of the Rondeltappe Bernoster Kemmers Foundation.

Cover image: Architectural paint research in professional practice – uncovering the successive layers on a wall, Open Air School, Amsterdam / *Marieke Kuipers*

ISBN 978-94-6186-802-2

© 2017 TU Delft - Heritage & Architecture

No part of these pages, either text or image, may be used for any purpose other than research, academic or non-commercial use.

The publisher has done its utmost to trace those who hold the rights to the graphic material used.

Designing from Heritage

Strategies for Conservation and Conversion

Marieke Kuipers

Wessel de Jonge



New cubicles inserted as part of the adaptive conversion of the Van Nelle Factory, Rotterdam by Wessel de Jonge Architects / *Marieke Kuipers*

Preface

The writing of handbooks for architects knows a long tradition. We are all familiar with that ‘primordial tome’ of the Roman Vitruvius, which from the early Renaissance served as base for hundreds of so-called *treatises*. A building tradition developed from the idea that good architecture could be described in the form of rules.

When classicism ceased to be the leading principle, the treatise lost its authority as well: when in the nineteenth century technology pushed architecture from its throne, space for personal insights and deviation in architectural language emerged. This right to freedom was not affected by the mannerism of post-War modernism.

It is therefore the question what form an architectural handbook would need to take to be relevant today. Social and technological changes are, after all, taking on such a radical form that architects have to be nourished by a broad interest in (news) media and the results of a diverse field of social, spatial and psychological research as the extension thereof.

But what is also becoming clearer is that architecture itself could take the lead when, in the midst of all these changes, the essential role of architecture is structurally rephrased. This cannot be architecture that presents itself as a result of uncontrolled social and technical developments, but architecture that, based on analysis and theory, achieves an independent position anew.

To my mind, *Designing from Heritage* does exactly what a handbook should do in our current context: stimulating careful observation and critical positioning by focussing the attention on that which is required to achieve architecture of value, or to sustain it. It poses as central question how current generations can engage design energy with the precision required to deal with the built heritage of previous generations: a forward-looking process of transformation as a method that leads to a respectful engagement with heritage.

Floris Alkemade
Chief Government Architect

Table of Contents

1 – Introduction	11
2 – Sleeping Beauty	15
2.1 – New Challenges	16
2.2 – Sleeping Beauty	18
2.3 – The ‘Zonnestraal’ Restoration Project	21
2.4 – Cultural Heritage and Architectural Design	23
2.5 – The future of Heritage & Architecture	28
3 – A Primer of Observation	31
3.1 – A Building Anamnesis	32
3.2 – Shearing Layers	33
4 – Interpretation and Valuation	65
4.1 – Built Heritage	66
4.2 – Principles	66
4.3 – Dialectic Heritage Values	68
4.4 – Cult of Monuments versus Cult of Modernity	71
4.5 – Analytical Mapping	72

5 – The Role of the Architect 99

5.1 – Strategy 99

5.2 – Research 103

5.3 – Practice 114

References 129

Colophon 135



Light Tower of the Chapel of Notre Dame du Haut by Le Corbusier, Ronchamp, showing traces of weathering on the rough plaster and crowned by a lightning rod /
Marieke Kuipers



Typical detail of the Olivetti Showroom designed by Carlo Scarpa for the partial conversion of a shop in the northern wing of the Piazza San Marco, Venice /
Marieke Kuipers

1 – Introduction

Designing from Heritage deals with challenges architects are faced with when dealing with the conservation and reuse of built heritage, with a focus on Modern Movement Monuments. It discusses how to carry out a thorough analysis and evaluation of monuments upon which their conservation and transformation can be based. It is meant for MSc education, but may be of interest to architects in general.

This book – the third in the Rondeltappe series – reflects the philosophy and didactic approach of Heritage and Architecture (H&A) section of the Faculty of Architecture and the Built Environment (Delft University of Technology). H&A has three chairs: Design, Cultural Value and Technology. They work in close cooperation to lay the foundations for the preservation and continuity of use of built heritage.

Designing from Heritage is strongly connected to the first book in the Rondeltappe series which deals with durability and sustainability of monuments, and with the second which advocates freedom in heritage based design. It contains the contribution of Prof. Wessel de Jonge – the Chair of Heritage and Design and principle at Wessel de Jonge Architects – and Prof Marieke Kuipers – Chair of Cultural Heritage in particular of the Architecture of the Twentieth Century and senior specialist of Twentieth Century Built Heritage at the Cultural Heritage Agency of the Netherlands (RCE).

This book is meant as a tool for architectural education and conservation for which research is as integral part of the design strategy.

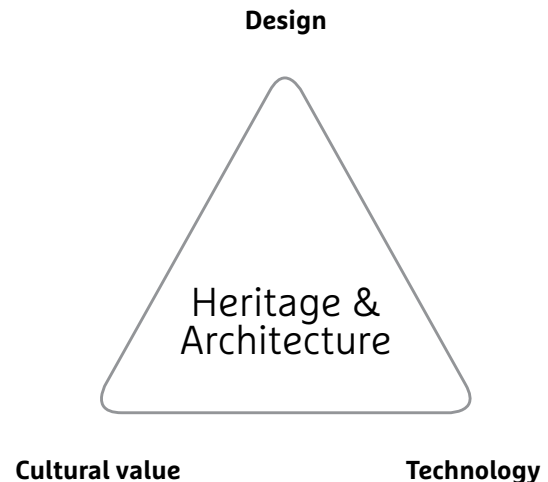

Designing from Heritage is subdivided in four chapters:

The first, a contribution by Wessel de Jonge, sketches issues of transitoriness and timelessness related to the reuse of Modern Movement monuments. Their values, characteristics and potentials are the foundations for architectural design aimed at guaranteeing their future lives.

In the second chapter, Marieke Kuipers presents a didactic exercise in critical observation of the architectural object.

In the third, she discusses the interpretation of tangible and intangible heritage values in order to specify the main characteristics and critical issues in relation to continuity and change.

Finally, Wessel de Jonge presents his experience of the role of the architect in relation to heritage value assessment, with specific reference to the conservation of Modern Movement monuments.



Corridor in the main wing of the former Ministry of Agriculture by Gijsbert Friedhoff, with original furniture and later added works of art, fitting in the spirit of place / Marieke Kuipers



FIG. 2.1 'Zonnestraal' Sanatorium, built 1926–1928, after restoration in 2003. The lightness of the structure almost makes the building dissolve into nature / Michel Kievits - Sybolt Voeten

2 – Sleeping Beauty

This chapter is based on the inaugural address of Prof. Wessel de Jonge. It presents the dilemmas related to the conservation and adaptive reuse of recent architectural heritage, with particular focus on his pioneering engagement with Modern Movement buildings.



FIG. 2.2 Het Schip housing block in Amsterdam (Michel de Klerk, 1921) is an early example of a twentieth century building that was listed in 1974 already / *Museum Het Schip*.

The field of operation for built heritage professionals has been widening in scope over the past decades in an unprecedented way. Early conservation professionals were mainly concerned with the restoration of neglected castles, historic mansions and ruinous churches. These represented only a limited quantity of outstanding pre-industrial buildings that were eventually also appreciated by the public at large.

Successive regulations in the Netherlands suggested that buildings had to be older than 50 years in order to ensure sufficient distance-in-time which would allow for a proper assessment of their historic value. This was reaffirmed in the first Dutch Historic Buildings and Monuments Act of 1961 and the subsequent selection of eligible buildings for legal protection pre-dating 1850. However, since 1980 new policies were developed to actively advance the listing and conservation of heritage buildings from the 1850-1940 period. In order to be able to pursue these policies as soon as the 50-years cut-off date and other administrative constraints would be lifted, a critical selection of such buildings was prioritised.^{1,2,3} [FIG. 2.1, FIG. 2.2]

- 1 Wessel de Jonge is Professor of Heritage and Design. His inaugural address was presented on 10 June 2016 under the title 'Sleeping Beauty - About Transitoriness, Timelessness, the Future and Architectural Design'.
- 2 Kuipers 1998a; Kuipers 1998b. Historic buildings dating to the period 1850–1940 were referred to as 'Young Monuments'. Buildings included in this prioritized selection were the Open Air School in Amsterdam, the Nirwana apartment building in The Hague, Hilversum Town Hall and the Sonneveld House in Rotterdam. See for details www.rijksmonumentenregister.nl.
- 3 For an overview of the development of the conservation movement see: Glendingning 2013.



FIG. 2.3 The Hilversum Town Hall (Marinus Dudok 1931) was one of the buildings prioritized for listing when the field of heritage preservation broadened to include the 1850–1940 period, and was listed in 1985 / *Arie den Dikken*



FIG. 2.4 Huis Sonneveld (Brinkman & Van der Vlugt 1933) was also one of the buildings preselected to represent the 1850–1940 period. It was listed in 1986 and is a house museum today / *Jannes Linders*

2.1 – New Challenges

The nomination and listing of recent architectural heritage appeared to pose completely new challenges to both the selection and the conservation in comparison to pre-industrial built heritage. [FIG. 2.3, FIG. 2.4]

First of all, many buildings of the modern era were constructed using steel, reinforced concrete and other new and often industrially prefabricated building materials. Their ageing and repair was still a blind spot in conservation practice while at the same time these new buildings methods caused modern buildings to decay more rapidly than many of their traditionally-built counterparts.

The sheer quantity of buildings built in the industrial era presented a second challenge. More buildings by far were constructed during the twentieth century than during all preceding ages taken together. The number of twentieth century buildings that needed to be reviewed for possible listing could have easily jammed the entire system of designation and funding if traditional procedures were to be followed.

New selection instruments had to be developed and hard choices had to be made in order to prevent indecisiveness and carelessness from leading to the loss of the valuable built heritage of our recent past altogether. Given the poor material quality and state of decay of many of these buildings, time was of the essence: it was either choose or loose.

Another crucial aspect was the continuous widening of the focus of attention in heritage preservation. When the first cultural heritage agency was founded in the Netherlands in 1918, those buildings that were generally regarded as architectural heritage included the traditional and pre-industrial built legacy that celebrated nobility through their palaces, the clergy by means of churches, and represented civic pride in the form of town halls and other monuments. Since the 1960s, the focus of attention widened to include more modest buildings representing societal developments and everyday life of the past as well as some early examples of industrial heritage. The legacy of the Modern Movement was coming into focus as part of a conservation-worthy legacy from more recent past.



FIG. 2.5 The Swedish social housing industry headed by Secretary Nils Melander, as depicted in a 1939 cartoon (left) / Ernst May's 1929–1931 Westhausen Siedlung at Frankfurt (right) / authors unknown

The paragons of twentieth century architecture and those of the Modern Movement in particular are mostly ordinary buildings that were designed to create a better life for the masses, often taking the form of healthy housing and schools, hygienic and day-lit workplaces or health-care facilities.

The conservation of these buildings posed an ethical dilemma: they were designed by architects who held critical anti-monumental stance,⁴ holding that buildings should be purely functional, and that, when having lost their function, they should be disposed of. This means that conserving the substance of these 'ordinary' buildings as 'monuments' goes contrary to their original 'idea'.

Many of the older heritage buildings could be maintained as museums or tourist attractions. The potentially high number of listed twentieth century buildings made this approach

unfeasible and implied that finding economically viable uses for them was the only way to lend them a second lease of life and safeguard their futures. [FIG. 2.5]

Modern heritage⁵

The socio-cultural and technological developments of the Industrial Revolution initiated an unprecedented process of urbanisation and a change of lifestyle suited to the spirit and new realities of the Machine Age. Modern times triggered a demand for new and specific building types, such as factories, infrastructural buildings and social housing. The functional programs of buildings also became increasingly diverse and specific. The vanguard architects of the 1920s took the perspective that a direct link exists between a building's design, its technical lifespan and user requirements over time. As the projected timespan for a particular use shortened as well, time and transitoriness became important issues in the architectural discourse, leading ultimately to either a transitory or to an adaptable architecture.

⁴ In 1937, Lewis Mumford (1895–1990) echoing the perspectives of Modern Movement architects, proclaimed '[t]he death of the Monument'. See Mumford, E. *The CIAM Discourse on Urbanism. 1928–1960*. 2002, MIT Press. Cambridge MA/London.

⁵ Henket & De Jonge 1990.



FIG. 2.6 The Van Nelle Factory as seen from the entrance in 1930 / Evert van Ojen – Gemeente Archief



FIG. 2.7 Sanatorium 'Zonnestraal' shortly after completion in 1928. The height of the spandrel depended on the use of the space behind it. / author: unknown - International Institute for Social History

The consequent translation of these ideas into practice produced some remarkable buildings, including the Van Nelle Factory in Rotterdam⁶ and its contemporary Sanatorium 'Zonnestraal' in Hilversum⁷ of 1928. [FIG. 2.6, FIG. 2.7]

Those vanguard architects were ruled by the principle of utmost functionality. A rigorous distinction was followed out between load bearing structure and infill to allow for maximum functional flexibility over time. Light and transparent materials were employed in façades to ensure unrestricted access of daylight and fresh air. Related to the idea of varied lifespans was the introduction of prefabrication of larger building components, which allowed for both the easy replacement of deteriorated parts, as well as future adaptation to respond to functional change.

⁶ The Van Nelle Factory was designed by Johannes (Jan) Brinkman (1902–1949) and Leendert van der Vlugt (1894–1936) during 1925–1931 and constructed between 1928–1931.

⁷ Sanatorium 'Zonnestraal' was designed by Johannes (Jan) Duiker and Bernard Bijvoet (1889–1979) between 1926–1928 and completed 1928–1931. The design team also involved structural engineer Jan Gerko Wiebenga (1886–1974). In this text, the name of Duiker is used so as to represent the team of designers.

They took advantage of the specific qualities of materials to build as lightly as possible, with a minimal use of material. Johannes Duiker (1890–1935), one of the foremost Dutch Modern Movement architects, labelled this philosophy 'spiritual economy' that, as he wrote in 1932, '...leads to the ultimate construction, depending on the applied material, and develops towards the immaterial, the spiritual.'⁸ In their search for optimal constructions, Modern Movement architects designed buildings that were extremely sensitive in terms of building physics.

2.2 – Sleeping Beauty

In his design for Sanatorium 'Zonnestraal', Duiker produced an early, and arguably his most direct, response to a short-lived functional program. Duiker advocated an architecture that was the result of reason rather than of style, and he attributed great value to the connection between form, function, material, economy and time.

⁸ Duiker 1932.



FIG. 2.8 The Dresselhuys Pavilion of 'Zonnestraal' in the 1930s / author: unknown - International Institute for Social History



FIG. 2.9 The Dresselhuys Pavilion in 2008 after the roof had collapsed / Rudolf Wielinga,



FIG. 2.10 The Dresselhuys Pavilion of 'Zonnestraal' after restoration in 2013 / Arie den Dikken

He argued that whenever a building's purpose had to change, the form would cease to have a right to exist and the building should either be adapted or demolished altogether. Duiker thus regarded buildings as utilities with limited lifespans by definition. He designed 'Zonnestraal' to be disposable: Based on a solid belief in Science and Progress, the complex was conceived in the conviction that tuberculosis would be exterminated in thirty years' time.

At 'Zonnestraal', Duiker managed to subtly balance user requirements and technical lifespans with the limited budget of the client, thereby creating buildings of breathtaking beauty and great fragility at the same time. Today 'Zonnestraal' – once pre-selected for future nomination as World Heritage – confronts us with the conservation of structures that were intended to be transitory.

[FIG. 2.8, FIG. 2.9, FIG. 2.10]

Design intent

It is clear that the conservation of such buildings poses great challenges in both conceptual and material terms due to their transitory character. Both of these aspects must be understood as part of the original design intent. Sanatorium 'Zonnestraal' seems to embody Adolf Behne's (1885–1948) original 1923 definition of 'functionalism' as opposed to 'rationalism'.⁹ Behne – probably inspired by the early works of the German architect Hugo Häring and more precisely by his 1923–1925 design for the Gut Gurkau Farm – defined functional planning as a design process that departs from the functional program and involves the careful design of individual spaces for each particular use with specific dimensions and performance characteristics, thereby organically producing a tailor-made suit.

⁹ Behne 1926. Although Behne wrote his text in 1923, before other major publications by Walter Gropius (1883–1969) and Erich Mendelsohn (1887–1953), it was only published in 1926. See also Heynen 2014.



FIG. 2.11 The interior of the Van Nelle Factory in the late 1920s, featuring novel light fixtures and a conveyor system / Jan Kamman – Gemeente Archief Rotterdam

At Sanatorium 'Zonnestraal' each room in the Main Building has its own dimensions and even the height of the spandrels vary according to the particular use of the space concerned. It is self-evident that the specificity of this architectural solution went hand-in-hand with a short functional life expectancy.

The factories for the Van Nelle company, designed almost at the same time, comply more with Behne's definition of 'rationalism' by providing large quantities of generic spaces of which the uses were expected to vary greatly over time. This is typical for production processes. The non-specificity of the factory halls suggested a long functional lifespan was projected, which in turn required a long technical life expectancy.

Sanatorium 'Zonnestraal' and the Van Nelle Factory demonstrate different architectural responses developed in the 1920s to the problem of short-lived functional life expectancy. These differences greatly influence their suitability for adaptive reuse today.



FIG. 2.12 A similar factory hall abandoned in the late 1990s, awaiting restoration and a new use / Wessel de Jonge Architects

A highly specific, tailor-made 'functionalist' building like Sanatorium 'Zonnestraal' may not be easily adaptable to functional change and is therefore likely to have a short functional life expectancy. The non-specific but generic 'long life, loose fit' spatial logic of the Van Nelle Factory lends itself rather easily to adaptation, as was demonstrated by its recent conversion into a centre for design studios and offices. Also for architects today, understanding this lesson from history holds the key to designing new and sustainable buildings for the future. [FIG. 2.11, FIG. 2.12, FIG. 2.13]

In short, even within the Modern Movement various architectural concepts have led to fundamental differences between modern buildings, which therefore require different design approaches when planning their conservation or adaptation. This underlines the need for a comprehensive study of not only the material aspects of a building, but also into the design intent or conceptual background thereof before making design decisions as part of a transformation or conservation project.



FIG. 2.13 After conversion into the Van Nelle Design Factory since 2001, the factory halls today accommodate design studios and offices. To the right, the double-skinned 'climate wall' / Michel Kievits - Sybolt Voeten

Going global

Ironically, the heritage designation of Sanatorium 'Zonnestraal' further canonized this transitory structure as a timeless masterpiece.¹⁰ However paradoxical the heritage status of Duiker's chef d'oeuvre may appear, the case of 'Zonnestraal' definitively altered the perspectives of the international conservation world. It inspired the creation of an international platform to share research and early hands-on experience in the conservation of 'modern heritage' among architects, heritage professionals, researchers, students and their teachers. This platform, called DOCOMOMO International – an acronym for the 'International Working Party for the Documentation and Conservation of Buildings, Sites and Neighbourhoods of the Modern Movement' – was established at the Eindhoven University of Technology in 1990.

¹⁰ Kuipers 2010. The earliest campaigns to safeguard 'Zonnestraal' were started by architects, among them J. Bakema, in 1960. After the building's listing in 1980 legal protection remained pending due to objections by the then owners. Preliminary protection became effective in 1983 while full legal protection followed only in 1988.

After more than 25 years of activity, DOCOMOMO counts over 60 national and regional working parties as well as several trans-national thematic networks.

The first steps taken then by the organisation still serve as a reference in the international discourse about twentieth century architectural heritage, that has now entered onto the agendas of such institutes as the UNESCO World Heritage Centre and the International Council on Monuments and Sites (ICOMOS) in Paris, and the Getty Conservation Institute in Los Angeles.

2.3 – The 'Zonnestraal' Restoration Project

The restoration and adaptive reuse project for the Sanatorium 'Zonnestraal' complex started in 1993.¹¹ The work on the Main Building was completed ten years later in 2003, and the exterior restoration of one of the two patient pavilions followed only in 2013, twenty years after the initiation of the project. The other pavilion had already been refurbished in the 1950s and still awaits restoration.

Due to earlier refurbishment of the Main Building, only the concrete frame, a few partition walls and a portion of the original steel window frames remained of the original building fabric and these could be preserved. The 2003 project further included the restoration of the original façades, partitions and finishes as well as some components of the service systems.

[FIG. 2.14, FIG. 2.15, FIG. 2.16]

¹¹ Henket & De Jonge 2010a, 2010b, De Jonge 2010a, 2010f, De Jonge & Henket 2010b, 2010c.. The project was conducted by Bierman Henket Architects, Wessel de Jonge Architects and Alle Hoesper Landscape Architects.

Designing from Heritage – Strategies for Conservation and Conversion



FIG. 2.14 The Main Building of Sanatorium 'Zonnestraal' after completion in 1928 / author unknown - *Het Nieuwe Instituut*



FIG. 2.16 After the removal of all later additions and alterations, this was all that was left of the original substance of the Main Building of Sanatorium 'Zonnestraal'. The upper corner shows the first test for the new glazing / *Wessel de Jonge Architects*



FIG. 2.15 The Main Building of Sanatorium 'Zonnestraal' after restoration in 2003 – a representation of the original idea and design intent, rather than original materials / *Michel Kievits - Sybolt Voeten*



FIG. 2.17 Looking through the drawn glass into the main hall on the first floor, featuring tubular radiators, light fixtures and linoleum flooring that were remanufactured for the restoration / *Jannes Linders*

Initially the view was held that the crucial value of this building lay within the conceptual intent of the original designers and the restoration project therefore aimed at revitalising the physical manifestation thereof. However, during preparatory research, it became apparent that the physical fabric was vital to make the full meaning of 'Zonnestraal' in its cultural context and time comprehensible.

The retention and – where necessary – restoration of physical fabric became an essential component of the ambition to revitalise Duiker's architectural concept successfully. Some lost elements – including the new steel window casements, the drawn window glass and the terrazzo floorings – had to be reconstructed carefully at high cost. Two original designs of linoleum were even remanufactured.

Replicas of mass produced parts from the 1920s, like window hardware and light fixtures, had to be handcrafted. Other elements could be replaced in a convincing manner by standard products that are still readily available. [FIG. 2.17] Even if the conservation of original fabric was only possible to a limited extent one can convincingly argue that it was a truthful restoration. The 'Zonnestraal' case confirms that the presence of substantial amounts of original material is not a prerequisite for conveying cultural and architectural-historical significance. This observation underlines the ambiguity of the notion 'authenticity'. Today, Sanatorium 'Zonnestraal' houses a variety of independent health services for outpatients, as well as conference facilities.

When the restored building was opened in 2003 it was as if Sleeping Beauty had not only awoken ... but had transcended her physical self.

2.4 – Cultural Heritage and Architectural Design

The role of the architect in the conservation, adaptive reuse and transformation of buildings that form part of our cultural heritage, requires particular knowledge and skillsets. The first and most important requirement is the inspired creativity and ingenuity of the designer. These lie at the core of any good architectural intervention. When dealing with an existing context or building, it should be the source of inspiration for creativity.

Successful projects are primarily based on making proper and responsible use of the existing qualities of a building. The architect should have highly developed professional skills and command a thorough knowledge of architectural history, including an understanding of the conceptual development of design principles and the related building technologies of the past. Only then will the architect be able to conceptualise a successful reinterpretation of the historic, cultural and architectural values of an existing context or building.

However, in order to develop a future-proofed architectural concept, it is also necessary to have knowledge of the parameters of economic value and the principles of sustainability as well as to understand indoor climate control concepts and technologies.

The architect should not necessarily be a top specialist, but rather be an integrator, operating in a team and collaborating with consultants. Their role include, for instance, the providing of advice on historic research, building physics, climate design and structural engineering. It also sometimes means cooperating with fellow architects with different fields of expertise. The role of the architect has changed from being the classic conductor of an orchestra into that of the bandleader of a jazz quartet where each member plays an instrument and is therefore equally indispensable. And yet: somebody has to set the tone.

The architect contributes both to the value creation for historic real estate and to a historic continuity by mastering all of this knowledge and integrating it with ingenious creativity. An inspiring synergy between old and new can be found in looking for compatibility and balanced contrast, rather than for creating conflict between current demands and existing characteristics – be they historical, architectural or technical.

By recognizing restrictions as challenges, the architect makes use of what is available and, in so doing, generally creates economically viable and sustainable solutions. Following these principles leads to smart designs that make optimal use of a building's properties and values.



FIG. 2.18 The Adambräu Brewery in Innsbruck after restoration in 2008 / *Christof Lackner*

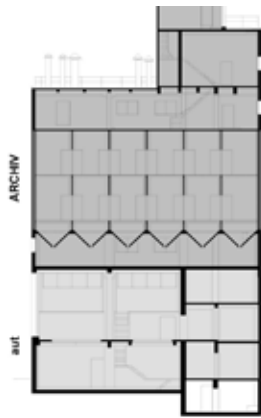

FIG. 2.19 Section of the Adambräu Brewery showing the perforated silos on top of the glazed brewery hall / drawing Köberl+Giner, Wucherer and Pfeifer Architects



FIG. 2.20 View through the diagonally perforated silos that today accommodate an architectural archive collection / Christof Lackner



FIG. 2.21 The Adambräu Brewery hall today serves as a venue for the Architects' Association of Tirol. This is now their auditorium space. / Christof Lackner



FIG. 2.22 The Convent of San Fransesc in Santpedor has been transformed into an auditorium by David Closes / Jordi Suroca

The Adambräu Building in Innsbruck serves as a small yet inspiring example of where a typology has been cleverly transformed. Lois Welzenbacher (1889–1955) originally designed this brewery in 1929–1932. Its cool and dark silos initially appeared completely unsuited to any new purpose, but thanks to their stable climatic conditions, the thick concrete silos were eventually found to be perfectly suitable to serve as an archive for architectural drawings and documents for the Tyrolean Architecture Centre. The three collaborating architect's studios, Köberl+Giner, Wucherer and Pfeifer, turned what appeared to be a disadvantage into a positive and useful aspect in their smart 2008 design.

[FIG. 2.18, FIG. 2.19, FIG. 2.20, FIG. 2.21]

Wherever a mismatch with a new functional use exists, the architect should have the capability to effectively intervene, as long as the historic qualities are sufficiently respected. A successful example of this is the 2011 transformation of the former chapel of the Convent of San Fransesc in Santpedor, Spain. The architect David Closes successfully transformed this sacred building into a modern auditorium. [FIG. 2.22]



FIG. 2.23 A power station in downtown Madrid after the transformation into the CaixaForum museum by Herzog & De Meuron Architects / Oscar Carnicero. Licensed under Creative Commons. Attribution-ShareAlike 2.0 Generic. Retrieved from <https://flic.kr/p/7stYGq>

The CaixaForum museum and cultural centre in Madrid is a former power station that was transformed by the architects Herzog & De Meuron between 2001 and 2007. They had to find a solution to the lack of much-needed public space around the building: carving out the ground floor of the power station helped to solve this problem albeit at the expense of the original interior fabric that was completely replaced by a new structure.

What all of these projects have in common is the remarkably sharp eye of the (re)designer, able to recognize and interpret the architectural qualities of existing structures which are not obvious to most people, which allows them to make cutting-edge design decisions. [FIG. 2.23]



FIG. 2.24 The Roman Theatre of Marcellus, completed in 11 BC / Maurizio Olmeda

Looking with other eyes

It is self-evident and generally accepted that the Roman Theatre of Marcellus dating from 11 BC forms part of our cultural heritage. Most people will understand that this old structure is not just a pile of rubble, even though its original function was altered by converting it into dwellings during the Renaissance. If, however, we consider the 1960 GAK Building in Amsterdam,¹² things become less self-evident. Some may affirm that it is old junk that should be torn down while others see it as an outstanding structure worth preserving. Yet in both cases, an architect should be able to find a clue to the definition of their individual and particular values. One of the most valuable contributions an architect can make to the successful reuse of heritage buildings is capacity to look at a building with other eyes, in other words in an uncompromised way. [FIG. 2.24, FIG. 2.25]

¹² The Gemeentelijk Administratie Kantoor (GAK Building), designed in 1957–1960, by Benjamin (Ben) Merkelbach (1901–1961), Petrus (Piet) Elling (1897–1962) and Alexander Bodon (1906–1993) is protected as a municipal monument.

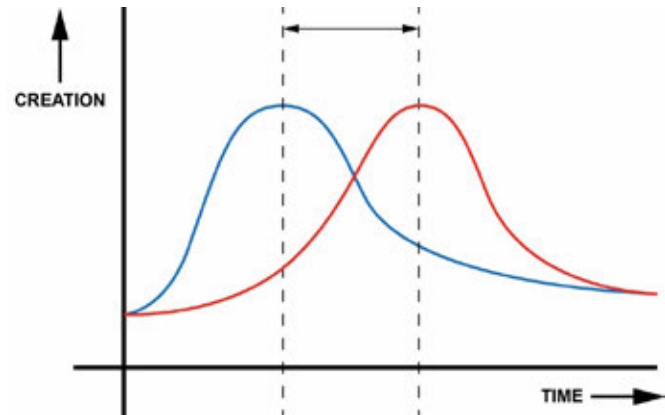

FIG. 2.25 A comparison of the 'creative curve' when designing new buildings (blue) and re-designing existing buildings (red) for which the creative process builds on a basis of research / Wessel de Jonge – TU Delft

Design dynamics

The design process typically requires much more preparatory research when working with built heritage or other existing buildings than is the case when designing new buildings. In dealing with heritage buildings, the design process takes its historic values and characteristics – established in part through careful historic research and building surveys – as points of departure. Historical and architectural qualities need to be assessed and interpreted into design guidelines for transformation; functional qualities, once identified should be translated into options for new functional programs. This helps the client see the potential of the property. This is an example of so-called 'research-based design'; a methodology with specific characteristics. The creative curve in research-based design shows how the creative process builds on a basis of research and interpretation that precede the actual design process. This may diverge from the dynamics of general design processes for new buildings, where the creative peak can be reached earlier in the process as fewer preparatory studies are mostly required. Such a difference in dynamics needs to be taken into account, for instance, when operating in teams with other designers and when planning the design process as a whole.



FIG. 2.26 The GAK Building in Amsterdam (Ben Merkelbach, Piet Elling, Alexander Bodon 1960) was abandoned in 2005 / Theo van Leur

2.5 – The future of Heritage & Architecture

To conclude, it is worthwhile to consider the future of our field of work. The vacancy of real estate is an increasing challenge in the Netherlands, as it is in many other European countries. Although many professionals in the real estate and building industry do not sufficiently recognise the full consequences, vacancy rates are still speeding up at an alarming rate.

Office buildings in particular are prone to obsolescence, due in part to the general economic downturn of the last years, but also, and more structurally so, due to new work formats that are being adopted. People increasingly work at home for a part of the week and share a workstation at the office. Even though a significant amount of obsolete office buildings have successfully been converted into housing during the last few years, the vacancy rate for commercial office space sky-rocketed in the Netherlands to 16% at the start of 2015.¹³ That translated to eight million square metres of vacant office space.

The Real Estate Chair at the Faculty of Architecture of the Delft University of Technology estimates that even when the economy has fully recovered, six million square metres of extant vacant office space will never get to be used as such due to fast-changing work habits.¹⁴

VACANCY RATES	YEAR	VOLUME	MILLION M ²
Vacancy office space	2017	14,1%	6,8
Vacancy office space	2016	15,8%	7,8
Vacancy office space	2015	16%	8
Vacancy retail space	2015	9%	2,9
Vacancy listed buildings	2015	4.000 buildings	2
Vacancy apartments above shops	2014	40.000 apartments	>3

¹³ DTZ Zadelhof 2015. This reduced slightly to 14,1% by January 2017 (Cushman & Wakefield, formerly DTZ Zadelhof 2017). Adaptive reuse has been actively stimulated in the Netherlands, through amongst others the National Redevelopment Programme, initiated in 2010.

¹⁴ Remøy, and Van der Voordt, 2007.



FIG. 2.27 The GAK Building in Amsterdam in 2015, after its transformation into housing for young professionals / *Luuk Kramer*

This is equal to about 70.000 average housing units, or 850 of the proverbial soccer fields. In addition to this, an alarming amount of shops stand vacant. At the end of 2015, this comprised almost three million square metres of unused floor space, to which can be added numerous churches and other religious, commercial and infrastructural buildings. Historic buildings account for an estimated two million square metres of the total of vacant floor space in the Netherlands.

These figures are still on the rise. Experts on the obsolescence of historic buildings at the Cultural Heritage Agency of the Netherlands (RCE) have already warned for many years that the vacancy rates increase by 'one farm a day, two churches a week and a monastery a month'. To this we could add: an office block twice a day!

Of course our society cannot afford to simply demolish every building that has lost its use, be this due to economic reasons (our pensions are invested in them, after all!) or the environmental effects in terms of sustainability.

Demolition leads to a huge amount of resources being discarded and wastes large quantities of embedded energy. In the case of buildings with historic significance, demolition becomes even less acceptable for cultural reasons. As the number of obsolete buildings is likely to remain very high in future, this will define the professional field of architects for the coming decades.

It is evident that most of the real estate of the future already exists. Architects need to offer their professional expertise to help finding ways of using this properly to serve societal needs. This can be done by preservation, adaptation or transformation, and by making our building stock more sustainable. [FIG. 2.26, FIG. 2.27]

Chances for heritage

It may seem paradoxical that the real estate crisis of the past years should lead to new chances for the revitalization of architectural heritage. Now that the economy is showing signs of recovery, we can assume that the funds and institutes that have traditionally invested in architectural heritage will continue to do so. But new stakeholders will also attempt to profit from the lowered real estate values and take advantage of the various incentives that have been introduced to address the vacancy problem in general.

Built heritage stands out due to a distinctive historic architectural character. This represents a unique selling point that will probably lead to a larger percentage of real estate investments being diverted towards the restoration and adaptive reuse of historic buildings. More historic buildings therefore can be lent a second lease of life and the volume of conservation and adaptive reuse projects is likely to increase. Built heritage professions, including H&A graduates and other young architects can seize the opportunities that are now opening up to kiss our sleeping beauties awake.



FIG. 3.1 Binoculars Building, designed by Claes Oldenburg, Coosje van Bruggen and Frank Gehry, Venice, Los Angeles / *Marieke Kuipers*

3 – A Primer of Observation

The internationally adopted *Guidelines on Education and Training in the Conservation of Monuments, Ensembles and Sites (1993)* states that ‘conservation requires the ability to observe, analyze and synthesize’, and that ‘the conservationist should have a flexible yet pragmatic approach based on cultural consciousness...’¹⁵

The many publications that are available on architectural conservation, design strategies and research address a variety of readers. Most of these present different approaches for looking at buildings.

The spectrum of ways of building observation ranges from viewing them purely as designed objects expressing the original intentions of an architect, to seeing them as inherited properties with publicly ascribed values, and to considering them as multi-layered structures that need special care to prolong their longevity. Some authors describe the personal views of the users of a building, others present the perceptions of property owners who may initiate and finance maintenance, refurbishment, alteration, extension, rehabilitation, restoration/conservation or the opposite, demolition.

The various approaches applied to heritage in the built environment are often meant to achieve a certain outcome, be it an aesthetical preference, a process of damage control, or an economic perspective on costs or benefits, to mention but a few.

Guidelines for a reasonably ‘clinical’ fabric-oriented observation of the built object in its present situation – as found and evolved through time under the influence of people and nature – are generally lacking. Such observation demands open-mindedness, consistency and curiosity, paired with precision. These are critical qualities after all, as further steps in developing architectural heritage strategies are based on the data collected by this process. [FIG. 3.1]

The intention of this chapter is to provide general instruction on how to observe an inherited building in its present state in a coherent manner.

¹⁵ ICOMOS 1993, par. 4.



FIG. 3.2 The Salle de Fête in the Aubette by Hans Arp and Theo van Doesburg, Strasbourg, with reconstructed colour scheme to the original design / *Marieke Kuipers*



FIG. 3.3 The old structure of columns, vaults and beams, combined with new (reversible) elements of steel allow for the reuse of the Great Church of Veere as a flexible stage for cultural performances. Designed by Marx & Steketeer Architects / *Marieke Kuipers*

3.1 – A Building Anamnesis

Special *Bauforschungs* (building archaeology) reports are often commissioned as a basic requirement before authorities allow alterations to listed monuments. Such reports, usually compiled by a trained building archaeologist, indicate the materials and (estimated) dates of the main components of a building. They also identify the respective values of the components in relation to the construction history of the whole. In general, the aim is to maintain elements with a (very) high historical value as far as is technically possible. Historic paint research can also be included as an aspect of the building archaeology report. This provides detailed insight into the successive finishings and colours of walls, doors, window frames and so on. Paint and colour contribute largely to the total appearance of a building in particular stages, after all. [FIG. 3.2]

We do not aim at such highly specialised investigations here, but propose that a systematic way of observing a building analogous to the conduction of a medical anamnesis be adopted. Medical anamnesis – the process of physical examination based on a patient's own memory – is guided by a specific series of questions. It is used to gain information relevant to the establishment of a proper diagnosis of certain conditions, on which the selection of a treatment can in turn be based. [FIG. 3.3] The intention of this chapter is to provide a general instruction on how to observe an inherited building in its present state in a coherent manner. In other words, how can we examine a piece of architecture, in the broadest sense, as it was built and has been modified over time, while also taking evidence of damage and possible repairs into account?

Although the legal status of a building is of no consequence for a proper observation, it is recommended that core historical and administrative data on the site be collected and studied prior to the field inspection. This data, or the lack thereof, and the questions that arise therefrom can sharpen the visual inspection.

HERITAGE ANAMNESIS QUESTION EXAMPLES	
Question	Aim/Supportive action
What building/structure/heritage site are we looking at?	Collecting administrative and quantitative data.
What is its aspect and has this changed in the course of time?	Collecting visual and usage data and measures.
What is it made of and with what building techniques?	Collecting construction and material data.
What are its characteristics?	Collecting data on the current appearance of exterior and interior.
Does it show traces of damage? Where and what?	Collecting data on current technical performance.

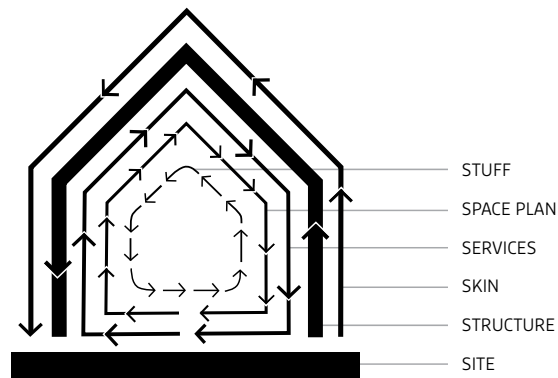

FIG. 3.4 Steward Brand's Shearing Layers diagramme from his book *How Buildings Learn* (adapted).

3.2 – Shearing Layers

We have adopted the framework formulated by Steward Brand in his well known study on 'how buildings learn' to structure our analysis of the tangible layers of a building.¹⁶ Brand's framework makes the observer aware of the integral physical coherence of a building, as well as the different rates of change that pre-defined layers go through. Brand's analysis is relevant to most building types, including houses and offices, but also to factories, churches, colleges, schools, grain silos and hospitals; in short, all those buildings, be they one decade or several centuries old, that could become eligible for listing as nationally or locally protected monuments.

Brand distinguishes six general-purpose layers for a building: Site, Structure, Skin, Services, Space Plan and Stuff.¹⁷ He also estimates a life cycle for change in each of these layers that varies from one day to eternity. [FIG. 3.4]

Seeing a building as being composed of interrelated layers, offers perspectives on estimating the impact of related interventions on its physical condition in terms of sustainability and, implicitly, for the long term success of architectural conservation efforts. Precisely because of its down-to-earth nature, we propose to conduct the analytical process of observing an building on the base of Brand's set of physical layers, which we extend.

Brand himself suggests adding a seventh 'S' as an aside, without giving this layer a structural role to play in his model. This 'S' represents the 'human Souls at the very end of the hierarchy, servants to our Stuff',¹⁸ in fact, the successive occupants of a building. Without denying the importance of the role of these actors, we propose an alternative seventh 'S' to form part of our building anamnesis. Our seventh 'S' represents the Spirit of a place and includes the intangible features of the place as layer, often invisible but nonetheless possible to be sensed and described.

¹⁶ Brand acknowledges continuing from the groundwork laid by Francis Duffy who explored the rates of change in office interiors for the RIBA (Brand 1994).

¹⁷ Brand 1994, pp. 12–13.

¹⁸ Brand 1994, p. 17.



FIG. 3.5 Diagramme of the Anamnesis process and tools / H&A student Marlissa Trompert.

We are not alone when we propose to augment Brand's model. An eighth 'S' has for instance been proposed to allow for Society's role as a multi-faceted actor on both the past and future evolution of buildings to be taken into account.¹⁹ We will address the influence of society in a following chapter and for now only focus on the examination of physical fabric.

Only a site visit can offer a personal experience of a place in its present state and in its three dimensions, including its visual relations with adjacent buildings, roads, waters, focal points, urban or landscape environment, et cetera. Observation is more than just looking. This experience, which is time-bound, is generated by all the human senses (sight, hearing, touch, smell, and taste) and will inevitably be subjective. However, the use of a pre-set questionnaire, or form, and ordinary equipment for recording – a sketchbook, notebook, camera, compass, measuring tools – as well as maps, historical and aerial photographs can assist in directing the observation in a way that is comparable to the process of anamnesis. [FIG. 3.5]

¹⁹ Schmitt & Austin 2016.



FIG. 3.6 The Old Synagogue, Pretoria, now vacant after temporary reuse as the venue of the Rivonia Trial / Marieke Kuipers

It is essential to make notes of first impressions, draw sketches, take photographs and to date all of these. In the end this information will provide the base for further, more objective, documentation, as well as a structured interpretation. A building anamnesis is different from a site analysis in preparation of a new-build brief because of the former's focus on the standing building in its present condition. However some basic questions are the same and more than one visit to the site is needed in both cases for a thorough observation.

Site

The term 'Site' has different meanings but, according to Brand, site is just 'the geographical setting, the urban location, and the legally defined lot, whose boundaries and context outlast generations of ephemeral buildings.'²⁰ The question is, however, whether the site has an almost eternal quality and is not subject to change or even disappearance? Apart from the impact of the weather, think of the risks that could result from a natural disaster (floods, earth quakes) or unwanted human activities that varying from armed conflicts to neglect or wilful destruction.

²⁰ Brand 1994, p. 13.

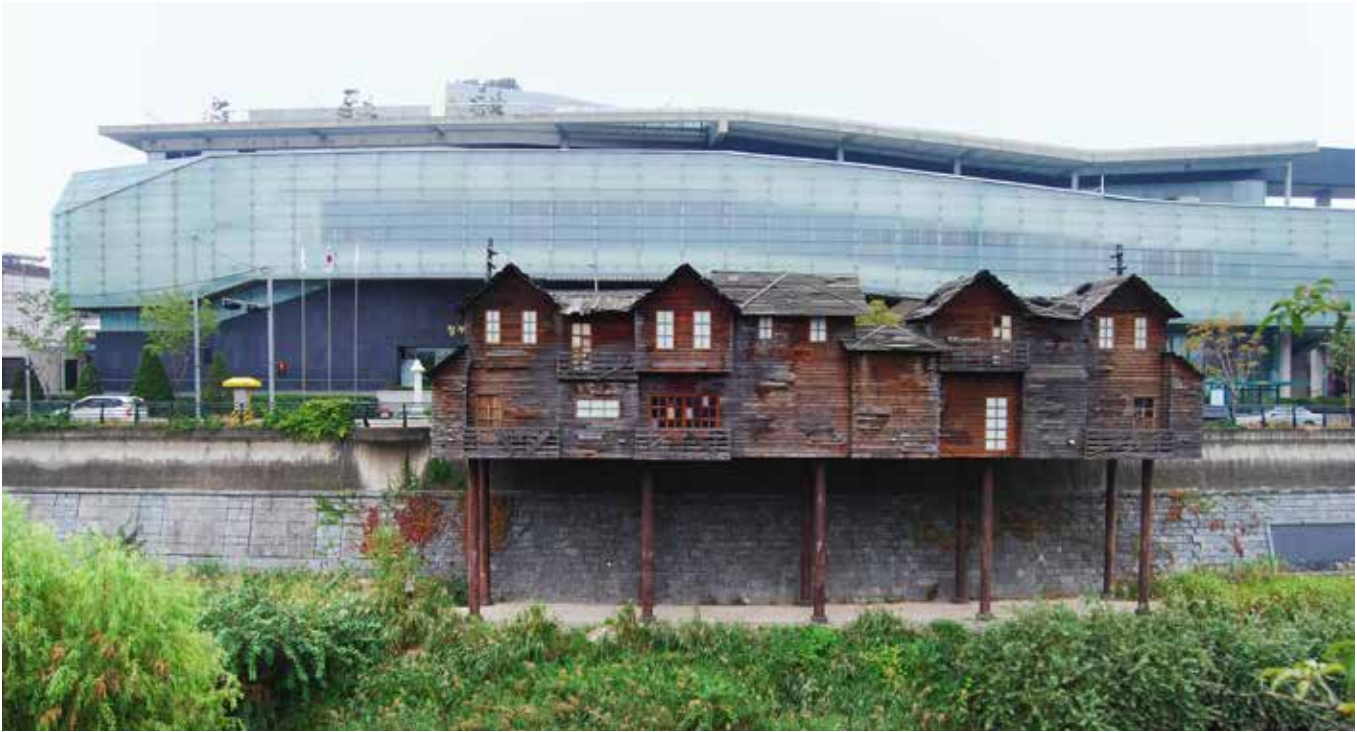

FIG. 3.7 Traditional wooden houses on stilts above the stream behind the Cheonggyecheon Museum, Seoul, after restoration; a tangible part of the city's urban history, Seoul / *Marieke Kuipers*

It is of collective concern that certain buildings, or their remains, might get lost if no preventative measures are taken. [FIG. 3.6]

Such preventive activities are usually associated with the various practices of heritage preservation, developed since the nineteenth century. These, in turn, have led to a specific use of the term 'site' for designated heritage places. To avoid possible confusion, UNESCO has recently opted to use the term 'properties' instead of 'sites' on the World Heritage List.

In our building anamnesis approach, 'site' refers mainly to the geographical location of a building. We must admit to a certain heritage bias that sets great store in the cultural and historical state of a particular location. [FIG. 3.7]

Archaeologists particularly are very keen on keeping/recording the findings in situ and conserving the place as it was found, thereby sustaining its primary source value for future generations. Our view, however, is that heritage buildings cannot survive without adaptation to new needs.

Designs for change should, therefore, be informed by a proper understanding of the heritage values and historical evolution of the built site and its setting. The geographical site observation has to be conducted in relation to soil, sun, street and surroundings/setting at least.



FIG. 3.8 Sorano, a Tuscan village built on tufa stone hillside / Marieke Kuipers

Soil

The soil is, in principle, the most solid part of the ‘site’ and it is no coincidence that Brand’s shearing layer scheme indicates it with a very bold line. It is physically the base on which the building stands and it could historically have been an important reason for settling on that particular place. [FIG. 3.8] The composition of the soil has great consequences for the foundations of the construction: building on a hard rock does not require piles, which are needed on marshy grounds. The composition of the soil also has implications for the drainage of the site. The level of the site – flat or sloping – always relates to soil conditions. These could also include the presence of watercourses that could be still flowing, filled-in or dried up. The soil conditions may have also influenced the direction of pathways on the plot and the layout of a garden or orchard. These should also be inspected.

GUIDING QUESTIONS FOR THE SOIL-SITE RELATION

What is the geological composition of the subsurface of the entire site?

Are there any indications of current or past water flows or bodies on the site?
What are they and where do or did they run?

What is the known level of the site, measured in meters below or above sea level?

Is the site flat, (partly-) flattened, or does it slope? If so, what is the estimated angle of the slope?

What can be observed about paths, pavements, stairs and such like on the plot and their location?

Are there any gardens, flowerbeds, trees, orchards and alike on the plot? What can you notice and where are they?

Are there any signs or risks of flooding, earthquakes or other geological processes?



FIG. 3.9 The Amsterdam Open Air School, designed by Jan Duiker, with loggias deliberately orientated southwards and a rooftop that was originally intended for lessons in the open air, weather permitting / *Marieke Kuipers*

Sun

The orientation towards the sun, the source of daylight and warmth, is an important determinant of site-specific climatological conditions, as are prevailing wind directions. Local planning or building codes and (private-) budgetary limitations often influence the choice for the occupation of the site in general, or for the exact location of the building on the plot. Local traditions or the personal preferences of clients and designers also have a role to play. [FIG. 3.9, FIG. 3.10] In the northern parts of Europe, an optimal exposure to sunshine is an important factor – one for which Modernist architects eagerly advocated – whereas the provision of shade for inhabited spaces is an equally important issue in southern regions [3.11]. The (partial) protection from wind, rain or snow is as critical. All these climatological conditions may influence the occurrence of damage on the site and to the building and should therefore be reported to.



FIG. 3.10 Typical 'stoep' or veranda surrounding a house in Pretoria provides outdoor space in shade / *Marieke Kuipers*

INFORMING QUESTIONS FOR THE OBSERVATION OF THE CLIMATOLOGICAL CONDITIONS AND THEIR IMPACT

What is the main orientation of the plot in terms of wind directions and what are the prevailing winds?

What is the course of the sun in summer and winter in relation to the site and the building?

Where are the shady and sunny parts of the site to be found, depending on the season/time of the day?

What climatological issues of wind, rain, snow and alike are relevant for this site?

Are there possible risks of increased weathering due to extant or planned neighbouring buildings; what and where?



FIG. 3.11 A view of the revitalized Cheonggyecheon Stream in its current urban environment, Seoul / Marieke Kuipers

Street

A site is often accessed from a street with a distinct name, though this is not always the case. Outside of cities and towns there could only be informal, sometimes unpaved, footpaths that provide the access to the heritage site. It may also be that no paths exist anymore at all. Where roads have names, these may refer to certain activities or buildings that are, or used to be, related to the place, for instance a market- or church square. [FIG. 3.11]

They could so refer to specific topographical elements that could have been relevant to the choice to build at a specific place.

The geographical setting of the site in the urban or cultural landscape, the cultural definition of the site's boundaries, the access, circulation and the position of the building in relation to the street all need investigation. Added to this are the administrative aspects such as size, zoning and ownership and so on. Once these are known, the current situation can be compared with previous stages in the evolution of the plot and the building(s) involved.

RELEVANT QUESTIONS WHEN OBSERVING THE STREET

What are the current and previous administrative designations of the site location or address?

What is the geographical setting of the site in the urban or cultural landscape?

Are the site's boundaries marked by any visible features such as walls, fences, hedges, ditches – including the access gates and paving – and what materials and sizes do they have?

How is the building positioned in relation to the street edge, noting distance and angles?



FIG. 3.12 The Sea Point public swimming pool, beautifully situated on the Atlantic Ocean, Cape Town / Marieke Kuipers

Surroundings and setting

The relation between a site and its surroundings can be examined both narrowly – focusing only on the surrounding elements of the main building on the plot of the property, its garden layout included – and in the broader context of the urban or landscape setting, reaching beyond the property boundaries. This context is often as dynamic as the site itself, but it has relevance to the origin, layout, appreciation and use of the site, its related views, its access and circulation. [FIG. 3.12]

For various building types, such as country estates and industrial heritage sites, specified guidelines are available to guide further investigations in detail.²¹

GUIDING QUESTIONS WHEN INVESTIGATING SITE AND SETTING

What is the current urban or landscape context of the site? Is it dense, rural, planned or unplanned, flat or hilly?

What kinds of buildings, landmarks, water elements or public spaces define the main features of the area?

What construction periods, styles, state of conservation/repair of surrounding buildings are relevant to mention?

What can be noted about open spaces and vegetation in the broader context around the plot including trees, greenery, shrubs and flowerbeds? Are they planned or unplanned?

What are distinctive views of or from the site? Are they historically defined and directed towards particular landmarks or trees and will they be sustained in the short term?

Is the site listed or is it located close to listed buildings and what is the site's role in this contextual relation?

Which nearby community facilities, such as churches, schools, shopping malls or parking facilities, are relevant for the site?

What facilities are available with which to access the site – think here of pedestrian walkways, cycling routes, parking lots, public transportation, stations, stops and shelters – and what is the type of the pavement of the access road?

How do people move to and from the site and how is the traffic organized around it?

Are there any invisible irritants that affect the site like noise, smell, smoke and pollution to note?

Are there any elements in the surroundings that have a negative visual impact on the views of or from the site, like electricity or telephone cables and drainage pipes?

What elements are located surround the main building on the property, of instance a pavilion, shed, sundial, et cetera?

Is there a distinctive garden layout and what are its characteristic features? Think here of noting not only its structure and style but also vegetation, greenery, trees, vases, sculptures, ponds, bridges, paving, and follies.

²¹ Douet 2013; SHBO 1987; Van Immerseel & Hendriks 2010.



FIG. 3.13 Brushed plasterwork on a contemporary house on the Cycladic island of Andros, typical of the local tradition / *Marieke Kuipers*



FIG. 3.14 Signs of weathering at Doorwerth Castle, the subject of a national debate in the Netherlands about its restoration that spanned the 20th century / *Marieke Kuipers*

Skin

The Skin is the most external layer of a building. Brand describes the skins simply as the 'exterior surfaces', be they high-tech curtain walls or traditional load-bearing walls.

[FIG. 3.13, FIG. 3.14]

He notes the accelerating mutability of the skins 'to keep up with fashion or technology, or for wholesale repair.' He also mentions the growing application of 're-engineered skins that are air-tight and better-insulated.'²²

Technically speaking, the skin is the interface between the internal structure and the outer environment. It should keep out wind and water, thus forming a shelter together with the roof. Recent developments in architectural engineering have brought smart skins that are responsive to the outdoor climate onto the market and new building envelopes that facilitate the climate control of the indoor environment are continuously under development.

²² Brand 1994, p. 13.



FIG. 3.15 Visible layers of repair in the wall of the medieval St Anthonis Gate, later reused as weigh house and place to demonstrate skills of brick laying for the guilds, Amsterdam / *Marieke Kuipers*



FIG. 3.16 Layers of time visible in the wall of the former Church of St. Columba Cologne, revived as a museum to the design of Peter Zumthor / *Marieke Kuipers*

The skin, generally speaking, defines the public appearance of a building. Skins are often specially designed to be looked at. This is often the case for the front or main façade of a building. The features of the façade – windows, doors and ornaments – and their distribution may reflect one or more architectural style(s) and can suggest a change in use over time. They can be important indicators design, fashion, maintenance and time and as such they are highly valuable informants from a heritage perspective. [FIG. 3.15, FIG. 3.16]



FIG. 3.17 The Bauhaus Main Building, Dessau, by Walter Gropius with its – partly reconstructed – curtain wall / *Marieke Kuipers*

In traditionally constructed buildings the outer walls can be either bare-faced or covered with a finishing like plaster or paint, or be (partly) cladded. Non-loadbearing curtain walls are mostly applied in multi-storey buildings. These lightweight screens usually consist of a metal framework and infill panels and often make extensive use of glass. [FIG. 3.17]

The patterns of the components' assemblage and the size and colour of the applied materials – think of wood, brick, stone, glass, metal, concrete and plastics – can be indicative for various periods of construction. In some cases, a work of applied art – a mosaic, mural, engraving, glass-in-concrete construction, sculpture – is integrated in the wall or attached to it. [FIG. 3.18]



FIG. 3.18 The Seine façade of the Louvre, Paris, with sculptured animal decorations incorporated into the main structure / *Marieke Kuipers*

A study of the skin can also show that service elements for lifting or climate control or energy saving – air conditioner boxes, awnings and solar cells – were added over time. They may form part of the original design but rather belong to the domain of the Services. A famous example of the latter is the exterior escalators and tubes of the Centre Pompidou in Paris.²³ [FIG. 3.19]

²³ Designed by Renzo Piano and Richard Rogers, 1971–1977.



FIG. 3.19 The exterior escalators and tubes of the Centre Pompidou, Paris / Marieke Kuipers



FIG. 3.20 The Second Goetheanum, Dornach. The roof forms an integral part of the sculpture-like design by Rudolf Steiner / *Marieke Kuipers*



FIG. 3.21 The roof of the administrative buildings of Old Raadsaal by the Dutch-born architect Sytze Wierda located on Church Square, Pretoria / *Marieke Kuipers*

Roofs are most exposed to natural elements and form the most vulnerable part of the building's exterior. Whereas Modernist architects had a strong preference for flat roofs – calling them the fifth façade and sometimes providing them with rooftop gardens or terraces – other architects adopted all kinds of roof shapes. [FIG. 3.20]

Their forms can vary from steeply pitched to vaulted or domed, be simple or composed of a complex configuration of volumes. Various sorts of covering are used in roofing. The use of these partly depends on the regional climate and availability of materials. Other elements can form part of the appearance and functioning of the roof: think of chimneys, skylights, gutters, widow's walks, spires. [FIG. 3.21]

Roofs are not always directly visible and not easy to maintain. Yet, they often make a crucial contribution to the typical character of the building and form an essential part of the skin. Therefore they should not be overlooked. The observation of the skin should begin with a visual inspection of the whole exterior (front, rear, sides, roof) and should continue with a detailed study.

LEADING QUESTIONS WHEN INSPECTING THE SKIN

What is the nature of the skin? Is it a screen, a finished surface, a bare surface, a hybrid or something else?

What kinds of materials and colours have been applied to which components?

What types of finishings have been used and what are their textures?

Are there any traces of changes, scars, or signs of weathering and if so, what kind, where, etc.?

Where is the main entrance and how is it made and articulated, or indicated?

What can we note about the windows, their type, glazing, frames, placing, etc.?

Are there any protrusions such as, balconies, loggias or similar elements through the skin or attached to it? Note their place, number and details.

What kind of roof shape and covering is present? Are there any indications in changes in this over time?

Are there any chimneys, gutters, external pipes, skylights, widow's walks, spires, eaves, et cetera and, if so, where are they, what form do they have and how many of them are there?

Are there other architectural or constructional features worthy of mention? What are they, where are they, and what are their noteworthy details?

Are there any ornaments/works of art/commemorative stones/signs? If so, where and of what materials are they made?

Are there other skin-related observations to note down?



FIG. 3.22 The columns of the concrete skeleton structure exposed on the ground floor level of one of the National University campus buildings (UNAM) of Mexico; the layout of the campus' pavement is also part of a structured design / *Marieke Kuipers*

Various topic-specific publications, and original construction documents and permits issued can be consulted during a second stage of observation to identify the materials used, the window types, ornaments and other elements. The depth of investigation may differ from case to case and depends in part on the complexity, age and significance of the building. It is important to employ a consistent measuring method on site. This applies for all layers and their sizes. When works of art applied to a building are encountered, it is highly recommended that a specialist be engaged to investigate further.

Structure

Even if the Structure is not always visible, it is the principal layer of a building. [FIG. 3.22] Without a structure a building cannot remain standing. The structure consists of the foundations and the load-bearing elements. In fact, 'they are the building' and, therefore, 'perilous and expensive to change' according to Brand.²⁴ Yet, it is technically possible to implement reinforcement or partial replacement of the main structure, while preserving the rest thereof.

²⁴ Brand 1994, p. 13.



FIG. 3.23 The 16-sided Bouwcentrum, Rotterdam (former exhibition centre on construction), built to the design of Joost Boks, topped by a glazed dome and built with a remarkable reinforced concrete construction expressed in both the interior and the exterior / *Marieke Kuipers*

Expert knowledge should be sought in order to obtain a comprehensive insight into the physical condition of and possible damages to the original structure and later alterations and the dangers these pose. It is useful nonetheless to identify any visible cracks, missing portions, signs of wear and tear and damages in the fabric because they may inform later decision-making. It is the role of the architect to define and coordinate the scope and tasks of other specialists and to consolidate the results of their investigations. This includes identifying the possible risks and opportunities for adaptive reuse.²⁵ While it may be prudent to engage a *Bauforschung* specialist to further elaborate the details of materials and the chronological layering, the architect should possess a sufficient understanding of the main structure, how it was made, of what materials and how it relates to the other layers, from the bottom to the top and from the inside to the surroundings.

Apart from the sizes of its elements, the observation of the structure includes its relationship to soil, shape, substance, skin, surface and space. [FIG. 3.23]

²⁵ Cramer & Breiting 2007, pp. 68, 91–92.



FIG. 3.24 A construction site with old concrete piles exposed, Oosterhout / courtesy of the Cultural Heritage Agency of the Netherlands

Soil and Foundations

The foundations connect the superstructure to the soil and transfer loads to the subsurface. Today, most foundations are embedded into the soil, but this is not the rule. Some traditional constructions are built on pad-stones, on stilts, or have posts stuck into the ground. Subterranean foundations, depending on the local conditions and the anticipated bearing capacity need can be either shallow – then often called footings – or deep. One footing type is the concrete raft foundation placed at the surface of the soil, spreading the load over a wide area. Deep foundations commonly consist of timber, steel or concrete piles. [FIG. 3.24]

These are hidden from view by the ground- and upper floors and the walls after construction. Because of this invisibility, the observer has to be extra attentive should parts of the foundations become visible or if signs of subsiding appear in the superstructure.

Consulting archival material can tell us what kinds of foundations have been applied. The foundations are the enduring base of the structure and determine the remodelling possibilities of a building.²⁶ They may even have been reused to carry a new upper structure from an earlier building, for instance after a fire.

GUIDING QUESTIONS FOR THE *STRUCTURE-SOIL* RELATION

What is the geological composition of the soil in which the foundations are embedded?

What is known about the possible preparation of site before construction? Did this have any relationship to load-bearing capacity of the subsurface?

What type of foundations – piles, slabs, other; materials, quantity, formats – were applied; how is it connected?

Are there any visible signs that repairs, additions or other interventions have been undertaken to augment the structure's stability?

²⁶ Brand 1994, p. 18.



FIG. 3.25 The entrance pavilion of the Sea Point swimming pool, Cape Town / Marieke Kuipers



FIG. 3.26 The upper part of the façade of the Notre Dame de Puy-en-Velay, where skin and structure are inseparable / Marieke Kuipers

Superstructures

Superstructures, that is to say the sections of structure above the ground, can generally be subdivided into three categories: traditional structures with load-bearing walls, often made of bricks, stone, wood or rammed earth; (modern) skeleton-frame structures, often to which non-load-bearing curtain walls are attached; and a combination of the two. [FIG. 3.25]

Load bearing walls often serve as façades or enclosures. They form an inseparable part of the Skin as well as of the Structure when they are exposed on the outside of a building. [FIG. 3.26]

Their surfaces can also be left uncovered in the interior, but frequently a thin finishing – for instance, paint, plaster, wall-paper, veneer and other finishes – is applied for aesthetic and/or technical reasons.



FIG. 3.27 The combined concrete frame and steel trussed structure of a former textile factory, Vishny Volochnik / Marieke Kuipers



FIG. 3.28 The curtain wall composed of prefabricated wishbone-shaped elements (Ergon) of the former ALSK Bank, Brussels, designed by Marcel Lambrichts / Marieke Kuipers

Skeleton frame constructions consist of systems of columns combined with beams, girders, horizontal slabs or decks and may be braced diagonally. [FIG. 3.27]

In high-rise buildings, columns are located over each other, their diameters decreasing from the bottom to the top to save weight. The whole frame is wrapped by curtain- or spandrel walls in which windows and doors are located. 'Blind' side-façades also occur.

Mixed structures combine an external supporting framework with non-load-bearing infill. [FIG. 3.28] They can often be found in traditional half-timbered farmhouses and cottages and or in one- to three storey high industrial buildings provided with steel frames and brickwork infill.



FIG. 3.29 The Erechtheion on the Acropolis, Athens, with the famous Porch of Carythids (now replaced by replicas) / Marieke Kuipers

Shape: Form and State

The term 'shape' can be applied both to the three-dimensional form of the main construction and its constituent components, as well as to the current state – the technical condition and distinct layers of time – that the construction exhibits. Supporting structures are not always visible and in those cases the form and size of the load-bearing elements need to be discovered from the construction drawings. In high-

rise buildings, the main elements of the construction are often exposed intentionally or unintentionally. Think here of columns, beams, frames, arches, trusses, vaults, et cetera. The visibility of such elements was already a reason in ancient times to underline their structural character through artistic means. The caryatids of the Erechtheion at the Acropolis of Athens are famous examples. [FIG. 3.29]



FIG. 3.30 The Gothic buttresses of the Maria Magdalena Church in Goes, photographed in 1900 / courtesy of the Cultural Heritage Agency of the Netherlands

The buttresses of Gothic cathedrals always catch the eye.

[FIG. 3.30] The Van Nelle Factory at Rotterdam is an impressive demonstration of a concrete framed structure with mushroom-capped columns located in the interior, decreasing in girth per floor. [FIG. 3.31]

Developments in technology aim at ever-larger spans and a minimum of vertical supports. Since form and substance are often strongly interconnected, it might be practical to observe these aspects all at once in relation to the major components of the superstructure. Keep in mind that substance, or fabric, is a key quality for the conservationist, while the form is often the first characteristic that attracts the attention of the architect.



FIG. 3.31 The concrete structure of the Van Nelle Factory, Rotterdam, with 8-sided mushroom columns, inside the curtain wall of glass and steel / courtesy of the Cultural Heritage Agency of the Netherlands

QUESTIONS WHEN STUDYING FORM AND STATE

Does the structure consist of load-bearing walls, skeleton frames or a combination thereof?

Are the load-bearing walls solid, or are they constructed as cavity walls? How thick are they?

What type of skeleton-frame is used, if any, and is it visible in the façade, as is the case timber-framing?

What aspects of the form and size of columns, beams, floors, ceilings, vaults, arches, buttresses and alike are noteworthy?

How are they various structural members connected?

Is there any indication of construction periods and/or later additions for strengthening the construction? If so, where are they located?

Are there any signs of subsiding or technical shortcomings in the load-bearing walls or structural frame, and if so, where?

Are there other aspects of form or its condition to mention in relation to the superstructure?



FIG. 3.32 Layers of time visible on the stairwell of the Van de Velde Building, Weimar, after the recent restoration of the Oskar Schlemmer mural leaving the remnants of the Schultze-Namburg period visible/ *Marieke Kuipers*

Substance, Outer Skin and Interior Surfaces

In conservation practice, the term substance is often employed in reference to the German 'Substanz'. This indicates the degree of original fabric in a historical building (material authenticity), which in turn supports the legibility of the various historical layers as witnesses of time (age and/or source value). [FIG. 3.32]

When we investigate substance, we aim to understand which materials – how, where and when – have been employed for the main construction of load-bearing walls, columns, skeleton frames, floors, beams, vaults/ceilings et cetera. [FIG. 3.33]

Figuring out in how far the availability and cost of materials at the time of construction may have influenced the historical design – or possibly later alterations or repairs – should be undertaken during a second stage of investigations. Since many structures are directly connected to the outer skin, or covered over by a thin finishing surface in the interior, structure, skin and can be best examined at the same time to avoid any overlap in the observation exercise.



FIG. 3.33 Polychromatic articulation of the fan-vaulted ceiling, King's College Chapel, Cambridge / *Marieke Kuipers*

QUESTIONS RELATED TO SUBSTANCE, OUTER SKIN AND INTERIOR SURFACES

What materials have been utilised to construct the main superstructure, be this outer walls or skeleton-framed?

Does the main structure accommodate a curtain wall or does it serve as the outer skin?

Is the material of which the main structure is made exposed or bare /uncovered on the exterior and if so, what is its texture: rough, smooth, shiny, matt, et cetera?

What materials were employed for the columns, beams, floors, ceilings, vaults, buttresses, arches et cetera?

Are there any signs of repair, weathering, corrosion, cracks or technical shortcomings in the superstructure? Which of these occur and where do they occur?

Which colours applied to the superstructure can be distinguished on the exterior?

What are the main finishes and colours of the supporting elements of the superstructure on the inside? (Refer also to 'Surfaces' and 'Space Plan', below.)

Are there other aspects regarding materials in relation to the interior surfaces of the supporting elements to note?



FIG. 3.34 Spatially connected rooms in a former Bruynzeel house, Stellenbosch / *Marieke Kuipers*

Space

No architectural space can be created without a load-bearing structure. Domes and vaults have spanned large spaces, often in impressive ways, since ancient times. [FIG. 3.34]

Nowadays, structural engineers collaborate with architects to apply newer technologies for large buildings and other structures, creating large unrestricted spaces with a minimum of supports. Only the technical relationship between superstructure and internal space is addressed here. The next section will deal with the Space Plan and related inner structures and the intangible aspects related to space will address the 'Spirit of Place'.

GUIDING QUESTIONS FOR THE *STRUCTURE-SPACE* RELATIONSHIP

What elements of the load-bearing structure are visible in the inner spaces and what is their effect on the spatial experience? Is this visible presence intentional or not?

What is the largest span of the largest space inside the building (approximate measures of length, width and height in meters)? In how far is the largest span defined by the limits of the load-bearing capacity of the structure applied at the time of construction? Where is this structure located?

Are there other technical aspects about the structure-space relationship to note?



FIG. 3.35 The sequence of arches in the crypt of the Pantheon, Paris, originally a church dedicated to St Geneviève / *Marieke Kuipers*

Space Plan

Following Brand, our systems deals with Space Plan only with regards the ‘...interior layout – where walls, ceilings, floors, and doors go.’²⁷ In our view, however, there is more to observe than just the physical elements that define the materialisation of interior spaces and the spatial organisation in the arrangement of rooms, their forms, sizes and proportions in relation to each other. [FIG. 3.35]

There are also the surfaces and colours of the floors, walls, ceilings and doors, as well as the vertical connections – stairs, elevators, and mezzanines – and the position of the windows to be considered. The way in which sunlight enters an interior can also be the result of intentional planning. [FIG. 3.36] When load-bearing walls define interior spaces, our investigations into Space Plan overlap with those into Structure.



FIG. 3.36 The carefully lit stairway in the Faculty of Humanities of the First University of the Republic of Turkey, Ankara, designed by Bruno Taut / *Marieke Kuipers*

When this occurs we need to examine the position of the structural elements in relationship to the plan both horizontally and vertically. The current layout could deviate substantially from the original plan, if known at all, due to the influence of various actors and factors. Such deviations may indicate the various stages of usage cycles that a building has undergone since its construction. Heritage conservation professionals usually identify these deviations as ‘layers of time’.

We suggest that the Space Plan be investigated separately from the main Structure. This exploration should include the Space Plan’s spatial arrangements, sections and spaces, storeys, stairs and surfaces as well its relationship to the street and the immediate surroundings. It is useful to make sketches of the plan and to draw some perspectives. In an ideal situation, copies of the original plan drawings (or later revisions) are at hand, allowing the investigator to make comparisons with the current situation. The level of detail of both the analysis and the documentation depend on the assignment.

²⁷ Brand 1994, pp. 12–13.



FIG. 3.37 A specially created 'window with a view' in the Groothandelsgebouw designed by Huig Maaskant, offering views of the dynamic city of Rotterdam / *Marieke Kuipers*

Space Plan and Street and Immediate Surroundings

The Space Plan is physically separated from the street and the immediate surroundings by the Skin and Structure. Often, though, there is a direct interrelation between the internal spatial organisation and the outer world, such as the orientation of sacred spaces towards Jerusalem or Mecca, or to certain stars. In houses, for instance, the kitchen was traditionally rarely located at the street side, being considered as not sufficiently 'noble'. Modernist architects tried to design from the inside outwards, so that internal function is expressed on façade.

They also tried to interweave exterior and interior by means of large windows, veranda's, sliding doors and alike to make the most of optimal orientation to the sun and fresh air. In some cases, panoramic views from inside outwards were intentionally 'framed', like the living room of Mies van der Rohe's Tugendhat House in Brno with its vertically movable glass façade looking out over the garden to Castle Špilberk in the distance. [FIG. 3.37]

Even in case of simpler heritage buildings and substantially altered interiors, it is still useful to investigate the architectural, practical, climatological and cultural or symbolical relationships between the actual space plan and the outer world. This can deepen the understanding of the interior as it has developed over time.

GUIDING QUESTIONS WHEN INTERROGATING THE SPACE PLAN, STREET AND THE IMMEDIATE SURROUNDINGS

How is the interior layout oriented towards the street? For instance, is the main access located in the middle, or at the side, et cetera?

How is access to the interior spatially organised, for instance through an external stair, a hall, entrance doors?

How does the internal layout relate to the immediate surroundings, including gardens atria and so forth?

Are there other relevant relations between exterior and interior layout in the current situation?



FIG. 3.38 The interior of the former laundry 'De IJsselstroom', now converted into an architect studio, Zutphen / *Marieke Kuipers*

Spatial Arrangements

The internal layout is the core of the Space Plan whether it was architecturally designed for a particular client, or constructed according to commercial standards for anonymous users. It is the '...stage of the human comedy. New scene, new set' as Steward Brand states.²⁸ He gives no clue, however, to the setup or the decor pieces. It makes a difference in the spatial experience of a building for instance, if it contains a vast central hall covered by a lantern on the rooftop, in comparison to one having no hall at all. In the spatial arrangement of a house, there might be a strong climatologically driven preference for the location of the kitchen, the living room and the bedrooms. Farmhouses and buildings that started their lives as such may have a typical distribution of spaces defined by the original functions, often tied to regional traditions. Despite later alterations, these can often still be recognised; a living room may have originally been built as a stable. Similar observations can be made in converted offices, churches, monasteries, hospitals and so on. [FIG. 3.38]

²⁸ Brand 1994, p. 21.

It is very important to look at the present position of all (partition-) walls, stairs, elevators et cetera, and to note particular features that catch the observer's eye when drawing or sketching the internal Space Plan. Ideally, these drawings should contain some on-site measurements. During the next stage of the interpretation and valuation, these observations will be compared to the available archival material in order to detect important alterations and additions. This kind of comparison can also help in determining a rough indication of the chronological evolution of the building and the relevant walls and other elements of the space plan.

RELEVANT SPATIAL ARRANGEMENT QUESTIONS

How many spatially distinct areas and spaces, storeys, stairs and elevators shafts can be seen?

What are, roughly, the proportions and sizes of the rooms?

Is the spatial arrangement of rooms based on a specific grid of proportions? If so what are its defining dimensions and how is this manifested in the Space Plan?

How is the current distribution of rooms, halls, stairs, elevators and similar connecting elements horizontally and vertically spatially organised?

How does the current spatial arrangement respond to daylight access?

Are the partition walls purpose-designed? Do they form part of a subdivision system, and, if so, which? Are they fixed to the structure or free standing? Are they original or from a later period?

What kinds of finishing have been applied on the partition walls? What materials, colours, textures and so forth have been utilised?

With what materials are the floors finished? Were they laid in special patterns? What is the character of their surface: e.g. smooth or rough, coloured or plain? The same for question should be applied to ceilings, doors, windows, doors, lintels, et cetera.

Are there any decorations or art works? Where are they located, what kind of art do they represent? What materials are they made of, by whom were they created and when?

What other aspects need to be noted in relation to the Space Plan in the current situation?



FIG. 3.39 External sewage pipes on a building in the old Carmo district of Lisbon / *Marieke Kuipers*

Services

The Services are what Brand calls the ‘working guts of a building.’ [FIG. 3.39] They include ‘communications wiring, electrical wiring, plumbing, fire sprinkler systems, HVAC (heating, ventilating, and air conditioning), and moving parts like elevators and escalators.’²⁹

²⁹ Brand 1994, p. 13.



FIG. 3.40 Architecturally integrated air conditioning systems in the former TPA Building, Pretoria / *Marieke Kuipers*

For cosmetic reasons, most wires and pipes are concealed in ducts, built into walls, or located in cupboards or special cable troughs. Switches, taps and fire protection apparatuses are usually located in full sight and are frequently replaced by newer versions for reasons of taste, safety, cost-reduction, hygiene and/or comfort. Heating and ventilation systems are usually partially visible (for instance, radiators, air-conditioning installations, and boilers), but the usually less-aesthetically pleasing service installations are hidden from view (for instance, convectors, engines, solar cell panels, water heaters, and coal storage boxes). In some cases, the application of an internal ventilation system is visibly incorporated in the interior spaces by means of (decoratively) elaborated grids or screens, a strategy often employed during the First Machine Age.³⁰ [FIG. 3.40]

³⁰ The First Machine Age, defined by architectural critic Reyner Banham, spanned roughly the period 1900–1930. During this period, European architects especially were greatly inspired by advances in engineering and technology. Banham 1960.



FIG. 3.41 A paternoster lift in former Post Office, Rotterdam / *courtesy of the Cultural Heritage Agency of the Netherlands*

As a rule, the services are static and fixed in place, but they can also contain moving elements, like the aforementioned elevators and escalators or external awnings, retractable escape ladders.

Encountering a functioning paternoster lift is a rare and novel experience nowadays. [FIG. 3.41] The same goes for original conveyor belts or still-operating permanent/historic window washing installations for curtain walls, but they used to be an indispensable part of the original concept of office and factory buildings. Sprinkler-installations are, however, more likely to still be present and are often capable of entering a new life cycle. In industrial and Modernist heritage buildings, one can sometimes encounter original control panels, mailing tubes and other installations, located in a clearly visible spot on purpose. Even if they are technically out-dated or considered as unsafe or unhealthy today, they often form part of the historic design concept. This presents us with a potential dilemma when we have to decide if they should be removed, substituted or conserved.



FIG. 3.42 Services in the servants' stairway of a multi-storied 19th century apartment building, Paris / *Marieke Kuipers*

We are often faced with similar dilemmas with regards to historic artificial lighting systems. The incandescent bulb- and fluorescent tube technologies in common use throughout the twentieth century are now being overtaken by LEDs and other recent innovations (which are, actually part of Stuff). Water reticulation service elements are also undergoing continued development in terms of old and new technologies and materials.

In European cities, the public provision of water, electricity and, later, gas to private properties was developed from approximately the 1880s onwards. [FIG. 3.42] Kitchens and bathrooms have since become the most frequently renovated rooms in the interiors of dwellings. This has consequences for the lifespans of related sanitary installations – sinks, toilets, baths, showers and so on – and one but incidentally chances on an authentic water closet dating to the early 1900s in a private house. Stumbling across original sanitary blocks in offices or factories dating to the period between the two world wars have become just as rare an experience.

During the first stage of a visual inspection, the observer therefore has to look for such historic service hardware carefully and document all that is found, including their type, location, materials and brand. Such documentation also helps to predict the nature of (partly-) hidden plumbing, cables and sewerage installations that connect the building installations to the public services network.

GUIDING QUESTIONS WHEN OBSERVING THE SERVICES LAYER

What kind of heating systems have been applied: central, distributed, individual, open fire, none, or something else?

Which aspects and elements of the heating system are visible – think of stoves, radiators, convectors, fireplaces, chimneys and such like. Where are they located and what are they made of?

What kind of ventilation systems are in use: natural, mechanical, collective, individual, none, or any other? What parts are visible, what are they made of and how, and where are they located?

What technical service elements – elevators, escalators, sprinkler installations, control panels, tubes, sliding rails and such like – of the first stage/s of occupation are still present? Where are they and what are they made of? Note their brand and date of manufacture, if these are indicated.

What historical water-related service elements – such as toilets, baths, sinks – are present? Where are they located? Are they branded?

What kind of materials and colours are used for which components?

Are there any traces of changes or scars, signs of weathering? If so, what kind, where, et cetera?

What is the type and location of inspection devices for the public services, including gas, electricity and water meters?

Are there other services-related observations to note?

Depending on the age, use, size and complexity of the building under examination, the number of service elements discovered can become quite large. Therefore the first-phase documentation needs to remain limited to only the most relevant elements. These are commonly found in the interior, notably in basements, attics, cupboards or even built into walls.

Some ‘passive’ service elements, like lightning rods or antennae, are attached externally to the skin, but do not form a structural or architectural part thereof and, depending on the case at hand, need not always be recorded.

Stuff

Stuff, the most internal building layer, is both the most spread-out and the most temporary. It is also the most personal layer. Brand groups the following objects together as ‘Stuff’: ‘chairs, desks, phones, pictures; kitchen appliances, lamps and hairbrushes; all the things that twitch around from daily to monthly.’³¹ It is not only the abundance of movable objects in buildings, but also their great variety as well as the great intimacy of objects, that makes it a near-almost impossible task for the observing architect to decide which of these should be recorded and to what level of detail. [FIG. 3.43]

It is usually the (original) occupants of a heritage building, or their heirs who decide which (personal) belongings they want to take with them to a new place, which objects they leave behind for use by new inhabitants, and which things they would like to give away, recycle or trash. They will act according to their own wishes and taste, because, as Brand notes, ‘the Space Plan and Stuff are what building users have to look at and deal with all day, and they rapidly grow bored, frustrated, or embarrassed by what they see.’ His conclusion is that: ‘between constant tinkering and wholesale renovation, few interiors stay the same for even ten years.’³² The status of a listed building could change this dynamic and may have a great impact on future interventions in the interiors.

³¹ Brand 1994, p. 13.

³² Brand 1994, p. 20.



FIG. 3.43 H&A students observing the interior and 'stuff' of an ancient church in Friesland / *Marieke Kuipers*

Obviously, it is practically impossible, and not necessarily useful, to compile an exhaustive list of all those movable objects, including personal objects, that represent the 'stuff' in a historical building. It is difficult to draw a line between the private movable objects that are so important for the historical interior of the heritage place and therefore should remain in situ, and those personal items that belong to an inhabitant. It is also not always easy to make a distinction between movable and immovable, especially when elements contribute to the surfaces. This is the case with box-beds, built-in clocks and control panels in a machine hall. These distinctions between the surfaces of the Space Plan and the Stuff could matter because of differences in legislation and, possibly access to heritage subsidies.

For reasons of practicality, it is best to focus mainly on the distinguishing furniture and furnishings, and even then to be selective in the observation. It must be borne in mind that typical furniture in a medieval church or in a historic town hall (like its ceremonial furniture, tapestries, mayors' portraits and sculptures), share a long history with the place.



FIG. 3.44 The fixed furniture of the council chamber of the Town Hall at Mainz designed by Arne Jacobsen and Otto Weitling in 1968–1970 and built during 1970–1974. The specially made carpet is an essential part of the interior / *Marieke Kuipers*

Religion-related objects – pulpits, organs, pews, rood screen, altars, communion benches, founts, stoups, chandeliers, et cetera – in chapels, churches, monasteries, mosques or temples, often also form an inseparable part of these important community structures. [FIG. 3.44] This is different to the Stuff of an unexceptional mid-twentieth century mass housing unit.

Private houses too can contain furniture that was purpose-made for a particular space and is therefore an inseparable resource for the interior. The chairs and cupboards in the Rietveld Schröder House in Utrecht are a good example. In exceptional cases, the houses of historically important people and their Stuff, including the material oeuvre of a renowned artist or architect, are preserved in situ. This has been the case with, for instance, the house of Frida Kahlo in Mexico City [FIG. 3.45], that of Konstantin Melnikov at Moscow [FIG. 3.46] or the house of Renaat Braem near Antwerp. In such cases all chairs, desks, tables, sofas and so on are noteworthy, whether they were specially made, mass produced or bought from a second-hand shop around the corner. We distinguish between furniture and furnishings for clarity's sake.



FIG. 3.45 The museumified interior of Frida Kahlo's studio house in Mexico City / Marieke Kuipers



FIG. 3.46 The intimate interior of the circular house of Konstantin Melnikov, Moscow / Marieke Kuipers

GUIDING QUESTIONS FOR THE FURNISHINGS OF A HERITAGE INTERIOR

Are there – particularly in case of public or religious buildings – any curtains, tapestries, rugs, draped wall hangings and such like, that were specially made for the place?

Which are these, where are they placed, what materials were they made of and what colours were used?

Are there any other typical elements such as mirrors, lamp fittings or paintings that provide a special heritage character to the interior to be noted? Which are these, where are they located and what materials and colours were used?

LEADING QUESTIONS FOR THE FURNITURE OF A HERITAGE INTERIOR

Are there any tables, chairs, beds, desks, cupboards and clocks that were specially made for the place? Note that these are often encountered in (semi-) public buildings.

Which are these, where are they placed and are they functioning?

What materials are they made of and what are their colours?

Are there any inscriptions to note, and if so where are they located?

What other distinctive movable objects that have a historical relation with the place, such as machines are worthy of mention? Are they inscribed and what are their type, location, materials, and colours?

It is very likely that more than one visit will be needed for the observation of an interior. Common sense should guide the first distinction between noteworthy and ordinary objects. Still, it is highly recommended that list of questions and points of attention be compiled during the first visit for future inspections.

It goes without saying that specialist expertise is required when dealing with heritage buildings containing remarkable Stuff.

Spirit of Place

Of all shearing layers, the Spirit of Place, or *genius loci*, is perhaps the most difficult to capture because it is mostly intangible and inexplicit. Yet, the *genius loci* of a historic place, or a cultural landscape, is perceived through the human senses when on a site. It is also very sensitive to change. The term, which originally referred to the spirit protecting a place, today refers to the distinctive and cherished atmosphere of a location.



FIG. 3.47 The ruins of Machu Picchu, where the spirit of place can still be experienced despite the crowds of tourists that come to visit this World Heritage Site / Marieke Kuipers

This concerns primarily the immaterial aspects of a place, that are in turn often closely associated with memories, beliefs, local traditions, narratives, rituals, performances and such like.

The basic idea that certain places have an individual spirit derives from ancient times and was often translated into a religious expression. These still persist in places still perceived as sacred, such as the Stone Circle of Stonehenge in England or the temples at Chichen-Itza in Mexico or Machu Picchu in Peru. [FIG. 3.47]

Following in the Romantic tradition and its appreciation of the picturesque, the term is now also widely applied in a secular manner to describe those inherent qualities of buildings and landscapes that provide their uniqueness of character and, for so far as this is applicable, their spiritual connections.

Like the aura³³ of a piece of art, this spirit of place can be very robust or extremely delicate. It is generated by perception and association. This spirit makes the observer aware of interrelationships between: stories and stones; spaces, light and shade; sounds and smells; time and movement; distance, volumes and scale; openness, transparency and closed-ness; climate and use, and so on. The 'spirit' unites the essential qualities that make a heritage building a place with a distinguished identity; in short, the 'spirit' imbues a place with a soul.

³³ Walter Benjamin, a German philosopher, essayist and cultural thinker first postulated the idea of 'auratic perception' in his essay *The Work of Art in the Age of Mechanical Reproduction*. Benjamin 1936

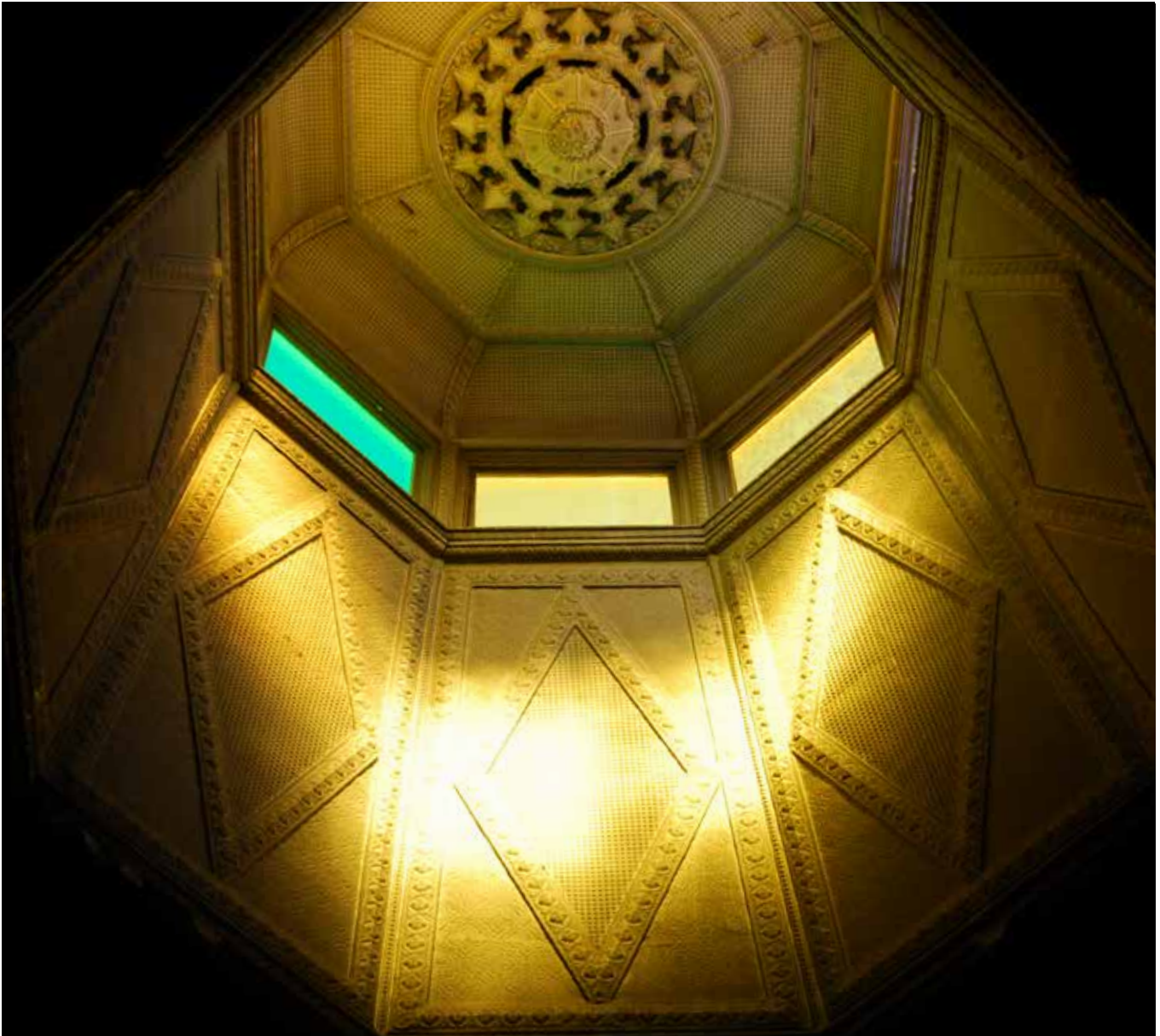

FIG. 3.48 The light from above that is an essential part of the spirit of place of the Old Synagogue, Pretoria / *Marieke Kuipers*



FIG. 3.49 Carlo Scarpa's carefully designed gates for the Querini Stampalia Foundation, Venice / Marieke Kuipers

Obviously, it will be a challenge to grasp the spirit of place in a handful of words, particularly if it concerns an old religious building or a richly furnished studio house of a famous artist, but at least it should be possible to make useful explanatory sketches and notes of key words that spring to mind when observing the heritage place on site.

Remarkably enough, no specific method appropriate to both architectural conservation and design to capture our observations of 'Spirit of Place' in a systematic way has yet been developed. The well-known and loved publications on how to detect visual qualities of townscapes can be useful for the general visual analysis.³⁴ *The Soft Atlas of Amsterdam*³⁵ could also offer inspiration for non-tangible aspects.

³⁴ See Lynch 1960; Cullen 1961; Venturi, Scott Brown & Izenour 1972; Alexander 1977; Rossi 1981.

³⁵ Rothuizen 2014.

QUESTIONS GUIDING INVESTIGATIONS INTO SPIRIT OF PLACE

What intangible characteristics reflect the Spirit of Place?

Can the heritage place be typified as a 'sacred place' and if so, why, or why not, or why not anymore?

Does the heritage place have a history and forms that are defined by religious practices or by (semi-) public functions? Which are they?

Is the heritage place still in use for worship and ceremonies? When and how often do these take place?

What other usages are relevant to the identity of the place?

What can be stated about privacy, public access, safety and comfort?

How can the spatial experience in terms of scale, distance, openness, alternation of light and darkness, rhythm, et cetera, be described when walking around and through the building?

What feelings and emotions does the heritage place evoke?

In addition to the observations made for the Site and Space Plan, what visual relations can be noted for the character of the place,

Are there any sounds and smells to note that are essential qualities of the heritage building, and if so, which are they?

Are there any nicknames known for the heritage building, and if so which? What associations do these evoke?

Are there other aspects to mention in relation to the identity of the place?

Observing and noting intangible qualities during site visits is not only necessary to gain a better understanding of heritage places as inherited creations that require care and respect [FIG. 3.48, FIG. 3.49], it also assists in compiling an indicative list of points of attention for our next steps of interpretation and valuation.



FIG. 4.1 *The enigmatic Sphinx in front of the Great Pyramid at Giza, the oldest of the ancient Seven Wonders of the World, both impressive and full of options for interpretation and valuation / Marieke Kuipers*

4 – Interpretation and Valuation

Based on the observation, introduced in the previous chapter, the next phase of investigation of built heritage deals with the (multidisciplinary) systematic interpretation of findings based on professional knowledge. This phase requires a clearly structured procedure to identify and classify the typical and characteristic features of the heritage building in its present state.

The intention is to establish a substantiated distinction between the general and crucial features that make a building a heritage site, as these should ideally be safeguarded for the future. Distinguishing those qualities that are essential to the heritage nature of a place is part of the broader analysis and valuation process undertaken when heritage buildings are investigated. [FIG. 4.1, FIG. 4.2]

Varying numbers and types of stakeholders are often involved in this process. The architect is just one of the stakeholders³⁶ that has a deciding influence on the frequently disputed practices of listing and conservation.³⁷ This chapter will present and examine the four successive steps of the built heritage valuation procedure.

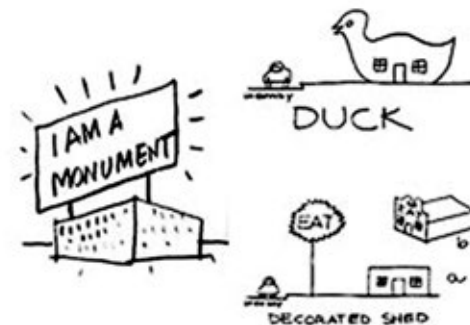

FIG. 4.2 Compilation of interpretative drawings about the 'forgotten symbolism of architectural form', from *Learning from Las Vegas* (1972) by Robert Venturi, Denise Scott Brown, and Steven Izenour.

³⁶ Howard 2003; Myer et al. 2016; Rodopoulou 2016.

³⁷ The terms 'conservation' and 'preservation' are often loosely used interchangeably, and also so in this text. They are not always the exact equivalents of similar-sounding terms used in the conservation practice in other languages.



FIG. 4.3 Anonymous contemporary drawing of the archaeologist Alexandre Lenoir in the crypt of the Basilique at St Denis, personally opposing vandalism of the Royal Tombs during the ravages of the French Revolution in 1793; a civic act that contributed to the later institutionalisation of historical buildings and monuments care as a national concern / source unknown.

4.1 – Built Heritage

But first it is necessary to discuss the extended evolution of the concepts of ‘historical monuments’³⁸ and ‘built heritage’³⁹ as cultural assets that belong to society in general. It is also important to note the crucial difference between architecture and heritage, as well as the fundamental distinction between history and heritage.⁴⁰ Built heritage entails, in principle, all kinds of physical structures inherited from the past that are publicly recognized as irreplaceable socio-cultural resources in the present. It is the combination of matter and meaning that makes the heritage buildings especially worthy of passing on to next generations. This amalgamation of tangible and intangible values has caused many a heated debate over a period of more than two centuries.

³⁸ Choay 2001; Sire 2005.

³⁹ Harrison 2010.

⁴⁰ Lowenthal 1997, p. x.

Those debates reveal the close inter-relationship between the so-called ‘architectural conservation movement’ and modern Western civilisation that has developed since the French Revolution and is deeply rooted in the ideas of the Enlightenment.⁴¹ [FIG. 4.3]

The care for built heritage is not just an individual activity but part of a broad societal engagement with the quality of the built environment. Today it is widely institutionalized and professionalized, but it was born as a civic response to the fast paced radical changes brought about in historical townscapes and rural areas by the massive destruction of old buildings during the Industrial Revolution. The architectural conservation movement, which sought to counteract the sense of loss that comes with progress, is as variable and dynamic both in ideology as in practice. On the one hand, a lot of confusion exists about the application of terminology for the various acts of architectural intervention in a historical building for the sake of its technical survival. This is especially so for the terms ‘restoration’, ‘preservation’ and ‘conservation’ and ‘adaptive reuse’, which will be discussed further below. On the other hand, the proper approach to the treatment of a damaged, deteriorated or dysfunctional heritage building, the ultimate goal of the movement, has also been the subject of controversy.

4.2 – Principles

The focus of these discussions basically varies between perspectives on two fundamental principles: ethics and aesthetics. The field of tension can be described as the search for historic ‘truth’ – by which a monument is seen as a historical document in built form (ethics) – versus the restoration of the heritage building back to its supposed former glory which has been lost over time (aesthetics).

⁴¹ Glendinning 2013.

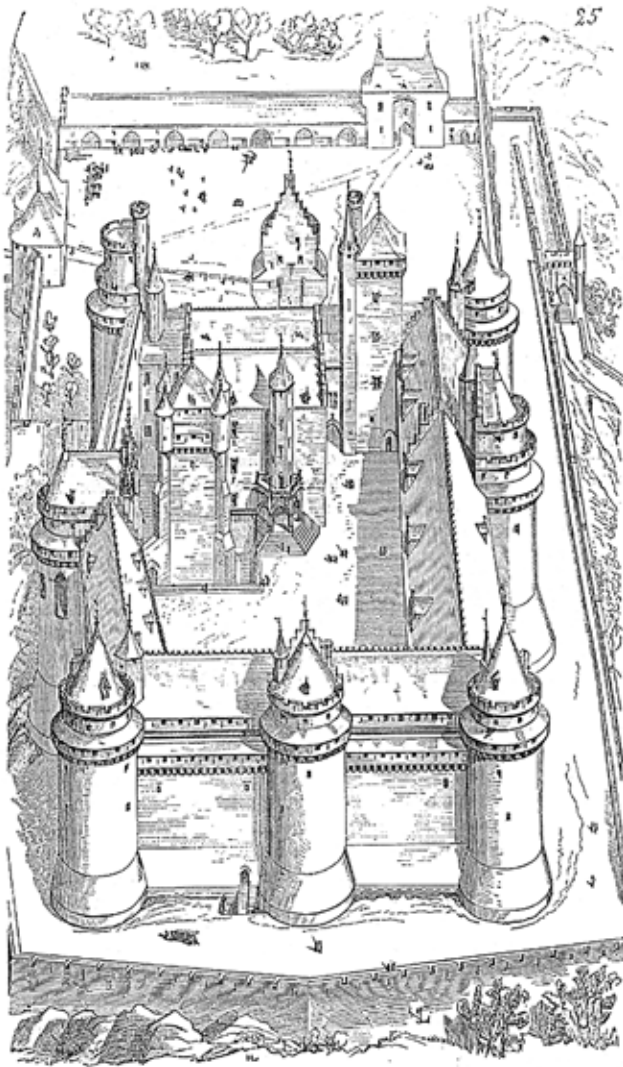

FIG. 4.4 Engraving of the restored castle of Pierrefonds by Eugene Viollet-le-Duc as published in his *Dictionnaire raisonné de l'architecture française du XIe au XVIe siècle* (1854–1868).

These opposite views about the primacy of the 'source value' or the 'image value' were most expressively formulated by the English art critic John Ruskin and the French architect Eugène Viollet-le-Duc respectively during the nineteenth century, but many others also voiced their opinions in many countries.⁴²

John Ruskin was together with William Morris the driving force behind the Arts and Crafts movement and was a founding member of the Society for the Protection of Ancient Monuments (SPAB, 1877). He valued highest in an ancient building the work of the craftsman along with the building's visible age, explicit in traces of old and authentic materials. Ruskin advocated maintenance and conservative repair of ancient buildings within their setting, liked with an honest expression of any intervention, rather than stylistic replacements.⁴³ He thus charged the conservation of the integrity of the material source with a moral or ethical imperative that is encountered in a number of twentieth century international guides and charters on conservation, like those of Athens (1931) and Venice (1964), and still persists today.

Viollet-le-Duc, by contrast, strove for the recreation of a stylistic unity based on scientific research and documentation. The spectacular restorations of the ruined castle at Pierrefonds and the fortifications of Carcassone are the well-known examples of Viollet-le-Duc's efforts to reinstate the 'former beauty' of an idealised style by filling in the missing elements to perfect a completed image of a 'historic situation that perhaps never had existed' as he put it in his own words.⁴⁴ [FIG. 4.4]

⁴² Boito 2000; Denslagen 1994; Glendinning 2013; Murtagh 2005.

⁴³ Orbasli 2008, p. 19.

⁴⁴ Viollet-le-Duc 1895.

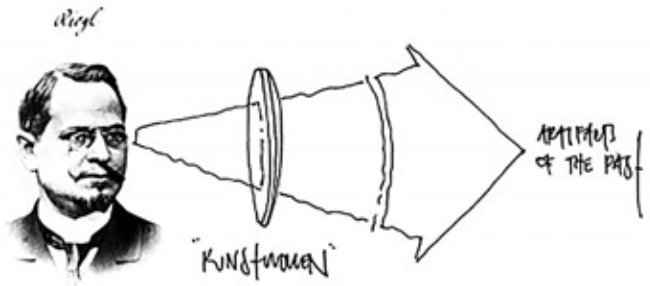

FIG. 4.5 A timeline for retrospective valuation of built heritage through Alois Riegl's filter / *E.R.A. architects*

The two conflicting approaches were called 'conservation' (to sustain the historic fabric as much as possible) and 'restoration' (to reinstate the historic image of a stylistically coherent unity). Like in England and France, debates on these approaches raged in Germany as well. There the conservationist Georg Dehio effectively summarized the new doctrine of the Ruskinian 'Anti-Restoration' movement as: 'konservieren, nicht restaurieren'.⁴⁵ However, this proved difficult to apply in practice in all its aspects, as any heritage building for which the ambition was that it should remain in use as a 'living monument', would require some degree of adaptation to practical needs.⁴⁶

4.3 – Dialectic Heritage Values

To make us aware of the complexities and contradictions in this dynamic relation with built heritage, the Austrian General Konservator, Alois Riegl – one of the most important founders of modern art history – formulated a dialectic system of essential heritage values. In his famous essay on the 'Modern Cult of Monuments' (1903), Riegl spoke of a 'cult' to indicate that the appreciation of the historic fabric was like a secular

reverence of the historic buildings as if they were sacred relics of the past.⁴⁷ He considered it a modern phenomenon because the cult was no longer in service of a religious belief, but an end in itself in service of society. Importantly, his dialectic set of heritage values was motivated independently of national politics or stylistic preferences (unlike other countries) or elitist preferences for highbrow cultural penchants (such as palaces or manors).

Rather than seeking merely a rationally motivated appreciation of historical buildings based on science and connoisseurship, Riegl observed a widely spread emotional attachment to old buildings based on moods and feelings (*Stimmung*) in modern society. He associated the appreciation of a clearly visible age in ancient buildings with a general psychological human need to be in direct contact with the past in an attempt to situate oneself in time and place amid an ever-changing environment. Old artefacts made by our predecessors, to whom we are the heirs, bear witness to bygone periods in our unrepeatable history. They rightly remind us of the passage of time – and of the natural process of death and life that comes along with ageing – since they were made, simply because they have physically survived. This physical 'age-value' of the fabric is attributed regardless of historical or artistic knowledge. Inevitably, the natural process of degeneration causes friction between an object and daily use, while modernisation and particularly technological innovation go on.

As Miles Glendinning⁴⁸ rightly notes, Riegl's central insight was that any concept of authenticity of a monument did not derive from its origin or from eternal values, but from its present day perception. [FIG. 4.5]

⁴⁵ Huse 2006; Wohlleben 1989.

⁴⁶ Glendinning 2013, pp. 147–152.

⁴⁷ Price et al. 1996/2016, pp. 69–83.

⁴⁸ 2013, p. 141.

COMMEMORATIVE VALUES	PRESENT DAY VALUES
Age value	Use value
Historical value	Art value
Intentional commemorative value	a. Newness value b. Relative aesthetical ('art') value.

The term 'monument' comes from the Latin verb 'monere' (commemorate, remind), and therefore indeed contains an imperative to remember. By means of the appellation 'monument', the heritage building becomes a carrier of commemorative values, but only as these are perceived in retrospect. For that reason Riegl made a distinction between those objects that had 'deliberate commemorative value' ('gewollte Erinnerungswert'), like Egyptian pyramids, obelisks and statues, and 'unintended' monuments: structures never erected with the aim to embody the memory of a certain person or event. These unintended monuments, the bulk of our built heritage today, can also be appreciated for their historical or aesthetical values.

According to Riegl, the historical value of a heritage building is exclusively associated with its historical moment of construction. It is perceived as a testament in stone and consequently, only the original form should be maintained or, if needs be, restored. 'Art' value (Kunstwert) can be attributed to a heritage building because it is almost like new, with intact (not damaged) forms, pure (not faded) colours and untainted (not blurred) lines. But Riegl also distinguishes a 'relative art value' that is based on a contemporary appreciation of accidental aesthetical qualities of old buildings: the 'modern in the old'.⁴⁹ Table 4.1 shows how Riegl's positioned the dialectic relationship of values. This serves as a prelude to our value-based decision scheme for issues of architectural intervention in built heritage, to be discussed later.

By making a distinction between commemorative values and present day values, Riegl argued that the dominance for one of these values – particularly the preference of 'age value' versus the 'use' or 'newness value' – indicated how to act towards the heritage building; in the extreme, either to let it decay or to sustain it by means of active intervention. For example, one option could be to leave a ruined castle just as it is in order to keep the 'age value' represented by the crumbling stones and patina, with the consequence that the ruin would decay further under influence of the forces of nature and, ultimately, disappear. Another option would be to repair all damage or other technical deficiencies in the monument and bring it back to a physically perfect state, as if it were still new and in so doing enhance the 'newness value'. Philosophically speaking the one option excludes the other.

In reality, however, decision-making is more complicated and this is the very reason why architectural conservation is such a complex task, particularly if the aim is to maintain, upgrade or expand the 'use value' (Gebrauchswert), which usually provides the economic basis for the maintenance interventions and is the driver for other investments. [FIG. 4.6]

A bit more than a hundred years has passed since Riegl published his built heritage value model. The twentieth century brought radical change and large-scale destruction to the built environment. The practice of conservation has now shifted towards regeneration and adaptive reuse and, sometimes, reconstruction or replication. Yet, Riegl's antithetical set of essential heritage values still offers a well-grounded framework for guiding the interaction with heritage buildings in the twenty-first century, despite possible criticism on some of his assumptions.⁵⁰

⁴⁹ Halbertsma & Kuipers 2014, pp. 55–57.

⁵⁰ Barassi 2007.



FIG. 4.6 The Great Hall (before it was reinvented as the Knight's Hall) adapted by Willem Rose through the introduction of cast iron 'Gothic' arches for the new use as the State's Archive at the Hague, about 1860 / photo: courtesy of the Cultural Heritage Agency of the Netherlands

Riegl's value set demonstrates that any act of conservation is somehow a compromise between, on the one hand the ideal of maintaining the historic 'truth' of material authenticity of the historic form and fabric as far as possible, and on the other hand the inevitable need to adapt technical and/or aesthetical performance to current needs to keep a building in daily use. [FIG. 4.7]



FIG. 4.7 The Academic Bookshop in Helsinki with its characteristic roof lights, designed by Alvar Aalto in 1962–1969 / Marieke Kuipers



FIG. 4.8 The Central Library of the University Campus of UNAM, Mexico-City, with mosaic murals by Juan O' Gorman / *Marieke Kuipers*

4.4 – Cult of Monuments versus Cult of Modernity

The twentieth century did not only see the institutionalisation and professionalization of building conservation by means of legislation, codification and education, it also brought the emergence of the international Modern Movement and its drastic ‘Cult of Modernity’. This can be understood as counter movement to conservation and continuity. Leading architects advocated a radical rupture with the past, traditional forms, ornaments and construction techniques in favour of innovative materials and technologies. In the name of progress, they argued that only a very select group of historical buildings and not the old urban fabric that did no longer suit the needs of the future deserved to be carefully conserved as monuments. But they also seemed reluctant to acknowledge that their pristine creations too were deemed to age and be altered, just like all other structures of the building stock.

Their polemical attitude, which sought an ever-present constant contrast between old and new, has caused a dramatic shift in the understanding and appreciation of heritage buildings and historic construction techniques.

In hindsight one could say that Modernist architects adopted a dialectic framework with regards to built heritage that was far more radically than what Riegl (who died in 1905) could have anticipated. The brutality of the wilfully created contrasts brought about by new large-scale buildings and massive demolitions in historic environments during post-World War II reconstructions, led to internationally accepted and endorsed charters on architectural and urban conservation and the World Heritage Convention (1972).

Ironically, the ‘test of authenticity and integrity’, related so strongly to the conservation movement, today also applies to the built legacy of the Modern Movement. Some of its highlights – like the Rietveld-Schröder house at Utrecht, the Bauhaus at Dessau, the Van Nelle Factory at Rotterdam, the Plano Piloto of Brasilia, the University Campus of Mexico [FIG. 4.8] or the oeuvre of Le Corbusier – are even inscribed on the World Heritage List. The claim that Modernist heritage buildings are still modern in spirit even if they are physically old and technically out-dated, creates more tensions and disputes about adaptive reuse or reconstruction than is usually accepted for other categories of architectural heritage, precisely because the conservation focus is often directed at original design intentions and rarely at material aspects.⁵¹

⁵¹ Kuipers 2005 and 2011; Prudon 2008; Salastie 2010 and De Jonge in this book.



FIG. 4.9 Central part of the façade of the AWW social housing block at Landlust, Amsterdam, originally designed by Gerrit Versteeg and renamed as 'King's Wives', with new stairwell window frames being installed during the renovation to the design of Archivolt Architects / Marieke Kuipers

In fact, the ageing monuments of the Modern Movement have proven to be less flexible in practice when adaptations to new needs are required, than promised by the original designers. The built legacy of the twentieth century demands innovative approaches to heritage analysis in combination with creativity if it is to meet the 'challenge of change'⁵² it is faced with. [FIG. 4.9] A critical review of the ideas on architecture of the Modern Movement's and their unforeseen side effects is necessary, especially in the light of the current dominance of newness and present-day values and the rising commercial 'Cult of Money' value that has become a serious menace to the philosophy and theory of conservation.⁵³ The 'throwaway' attitude of the Modernists towards the past is no longer tolerable in view of the current challenges of adaptive reuse, sustainability, re- and upcycling in our built environment. Architects and other stakeholders now have to be familiar with new methods of integrated planning and design in which the continuity of heritage values is assured by an intelligent and respectful combination of conservation and development.

⁵² Van der Heuvel et al. 2008.

⁵³ Dushkina 2010, p. 198.



FIG. 4.10 A typical detail of modern heritage: a steel framed window with traces of corrosion in a wall of glass bricks, part of the Salime Hydro Power Plant / Marieke Kuipers

4.5 – Analytical Mapping

Recent practice in architectural conservation demonstrates a high dependency on the client, the conservation authorities and heritage architects. Their ambitions and expertise dictate how the intervention – ranging from restoration to re-architecture – is answered. It is generally accepted that conservation aims at managing change, but parties often disagree on the ways in which the change is manifest. Some countries stipulate that extensive research is undertaken – often designated to specialists in building archaeology and/or cultural/architectural history – before new plans are drafted to change a heritage building. But as this is not the case everywhere, it is highly desirable that architects are trained in procedures for analysis. [FIG. 4.10]

We have defined four steps for this much needed analysis.

[FIG. 4.11] They result in supportive graphic visualisation of the relevant facts, fabric, forms and values.

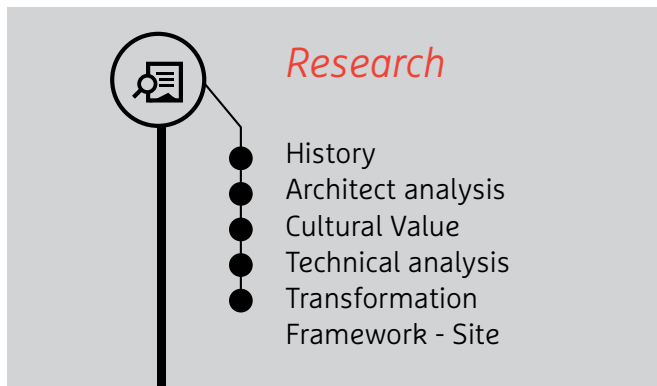

FIG. 4.11 The detailed stages in the HA research process in relation to the architectural intervention assignment / Marliisa Trompert (H&A/TUD Master's student)

Before any analysis can take place we need to first take step zero: collect and collate data, including original drawings and findings of on-site observation (see chapter 3).

The successive analytical steps, which synthesize the findings about a heritage site and aid to communicate these to others, are:

- 1 to compile the construction history of a heritage site by means of 'chrono-mapping';
- 2 to identify and classify the site-specific heritage features by means of 'value-mapping';
- 3 to differentiate the identified features on three levels of significance;
- 4 to distil a position statement based on outcomes of steps 1 to 3 above about opportunities for possible interventions and obligations for conservation and identify crucial dilemmas for the continuation of the heritage building.

STEP 1: 'Chrono-mapping'

The first step of the analysis process aims at developing insight into the genesis of the heritage site, its evolution and status quo by 'mapping' how, when and where the building was constructed and has since evolved to its present state.⁵⁴ The aim is to compile a referenced recording of the heritage site that can serve as a reliable source of information as to what is actually there in terms of location and materials and their chronologies. A lot of data needs to be collected relating to the construction history and evolution of a place. This requires archival and historiographical research (maps, drawings, photographs, movies, correspondence, publications) and can also include interviews, all in addition to the interaction with the visual observation of the heritage site.

MAIN QUESTIONS FOR THE PHASES OF EXPLORATION AND DOCUMENTATION

What is known of the original construction site, its location, size, orientation, name, et cetera?

What is known about the original brief, its date, the name of client/occupant, the original function of the building, et cetera and possibly even of the original designers and contractors? Commemorative stones can be of assistance here if they exist.

What is known of the originally used construction materials and colours?

What is known of the applied works of art that are still present, where are they, what are they and who were their makers?

What is known of the original spaces – their volumes, sequence and views – and, technical equipment – lighting, usage, machinery et cetera, inside the building?

What is known of subsequent interventions like additions, partial demolitions et cetera. When, where, why, by whom, for whom and with what materials, et cetera were they undertaken?

What more is there to note about the genesis of the heritage site and its surroundings?

What is more to note about relevant features found in the interiors such furniture, clocks, signs, inscriptions et cetera?

What is not known but deserves to be investigated later on?

⁵⁴ The same obviously goes for complexes that consist of more than one building, or historic estates, et cetera.



FIG. 4.12 Museumified interior of the Kandinsky-Klee Master's House at Dessau / Marieke Kuipers

The level of detail and precision achievable in these investigations may differ from case to case, depending on the availability of sources, budget and the time available for field and archival research. The complexity of the site is an important factor as well. Nowadays, building archaeology specialists can be contracted to conduct this research, but a heritage architect also needs to acquire sufficient knowledge of the site's construction history for further interpretation and valuation in relation to the assignment of intervention.

A number of available sources offer useful instructions to various degrees of detail on how to survey a historic building.⁵⁵ However, we still need to develop a specialised method for the survey of industrial or twentieth century heritage because there is much more archival material available on the origin and evolution of these heritage categories available than for the pre-industrial heritage.

⁵⁵ Cramer & Breitling 2007, pp. 45–93; Stenvert & Van den Tussenbroek 2015; Watt 1996/2015.



FIG. 4.13 The restored cinema hall of the Art Deco Tuschinski theatre at Amsterdam (originally built in 1921), with murals by Pieter den Besten (recently restored) and new emergency exit light / photo: courtesy of the Cultural Heritage Agency of the Netherlands

Such a modern building archaeology research was conducted for, for instance, the adaptive reuse and conservation of the Van Nelle Factory at Rotterdam, in which case not only the floor plans, but also the façades and interior spaces were included in the chrono-mapping.⁵⁶ In other cases, detailed research has served the reconstructive restoration and museumification of seemingly-frozen interiors, like those of the Bauhaus⁵⁷ and master houses at Dessau,⁵⁸ [FIG. 4.12] Le Corbusier's houses in the Weissenhof settlement in Stuttgart,⁵⁹ the Sonneveld House at Rotterdam⁶⁰ and the colourful art works in the interior of the Aubette at Strasburg.⁶¹

⁵⁶ De Jonge/Fischer 1999–2002.

⁵⁷ Markgraf 2006.

⁵⁸ Gebessler 2003.

⁵⁹ Adlbert 2006.

⁶⁰ Adriaansz 2001.

⁶¹ Guigon et al. 2006.

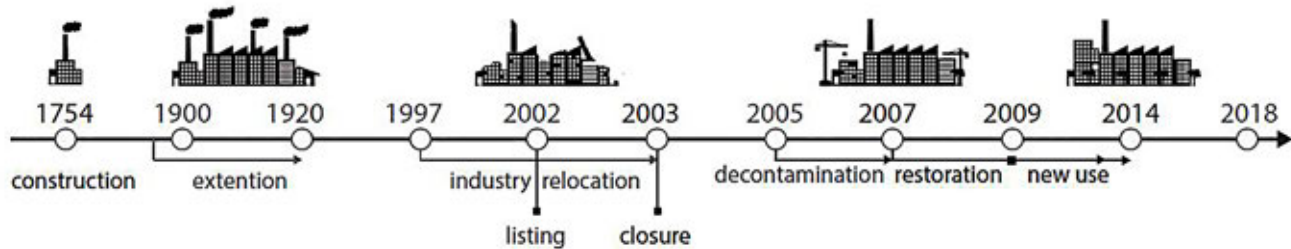

FIG. 4.14 Timeline of the evolution of the industrial site of the DRU, Ulft / Dora Rodopoulou

Even when technical upgrades aimed at continuing an existing use are planned – like the interventions implemented in the Art Déco Cinema Tuschinski in Amsterdam,⁶² [FIG. 4.13] or the post-World War II airport terminal of Orly⁶³ – investigations in situ in combination with chrono-mapping are vital to properly understand how twentieth century heritage buildings were actually constructed.

Visualizing Layers of Time

Whatever the type of heritage building and the goal of treatment (repair, conservation, restoration or reuse) will be, the investigations have to result in a purposefully illustrated report with a synthesis of the findings. It must be visualized in an objective manner to indicate the main phases of the construction history and the still visible features that are relevant to the heritage character. This chrono-mapping can best be done by means of annotated coloured plans, sections and elevations of the building as well as relevant interior

spaces, indicating the main construction period per part. Collages or an illustrated timeline [FIG. 4.14] can also provide an overview of important features or the historical context and main dates of alterations respectively.

Many specialists already compile a valuation map in this stage to indicate what parts of a heritage site have high, medium or indifferent building archaeological values. The interpretation of values is often based on the chronological order of construction with the oldest parts as the most valuable, but this phase of interpretation should preferably be delayed until the mapping of values and levels of significance (see steps 2 and 3, below) have been completed.

⁶² Rutgers & Doornenbal 2003.

⁶³ Briolle & Repiquet 2012.

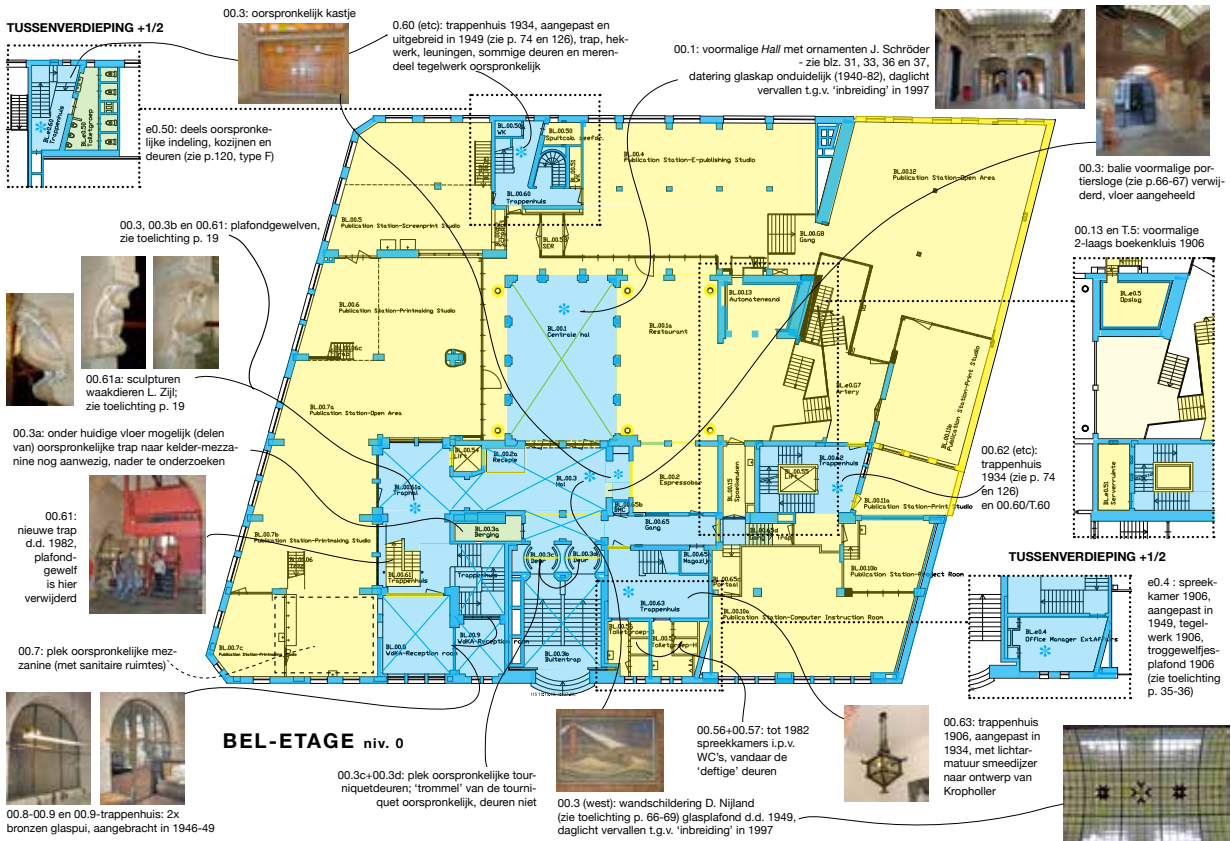

FIG. 4.15 Page from a documentation report of building archaeological and historic paint research of a former bank office building in Rotterdam indicating heritage values (with colouring according to Dutch guidelines) and indicating typical features of the interior and their location / Suzanne Fischer



FIG. 4.16 Overview of the Manutencao Militar Complex in the parish of Beato in Lisbon, located parallel to the Tagus River as seen from the top of the complex's silo / Marieke Kuipers

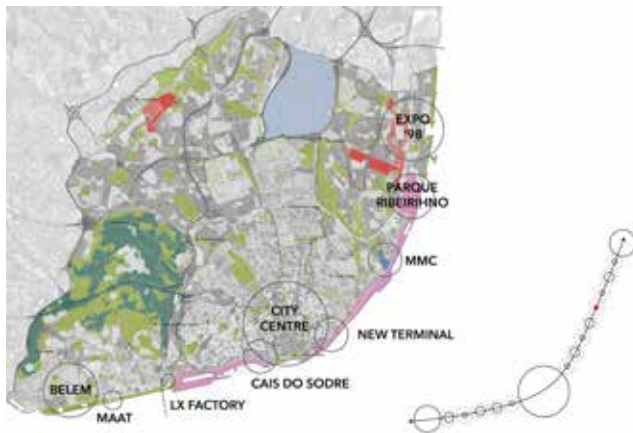

FIG. 4.17 Location of the Manutencao Militar Complex (MMC) on the Lisbon waterfront / Guido Martin (H&A/TUD Master's student)

Notwithstanding this important remark, the picture on the facing page [FIG. 4.15] illustrates where typical features are located and how the complicated construction history can be visually explained.

The experimental work of H&A students who investigate the Manutenção Militar complex (MMC) at Lisbon during their Graduation Studio in 2016-2017 provides some illustrative examples of how to visualize the evolution of a heritage site.⁶⁴ This now-vacated military complex of about twenty industrial buildings grew between 1889 and 1974 from a seventeenth century nunnery, the Convento das Grilas . [FIG. 4.16] The MMC is located more or less parallel to the River Tagus and mainly served to production rations and other supplies to the Portuguese army and navy. [FIG. 4.17]

⁶⁴ The studio started with participating in the international student workshop that was initiated by DOCOMOMO International, in collaboration with the Technical University of Lisbon and with the support of the Municipality of Lisbon (www.docomomo2016.com/workshop).

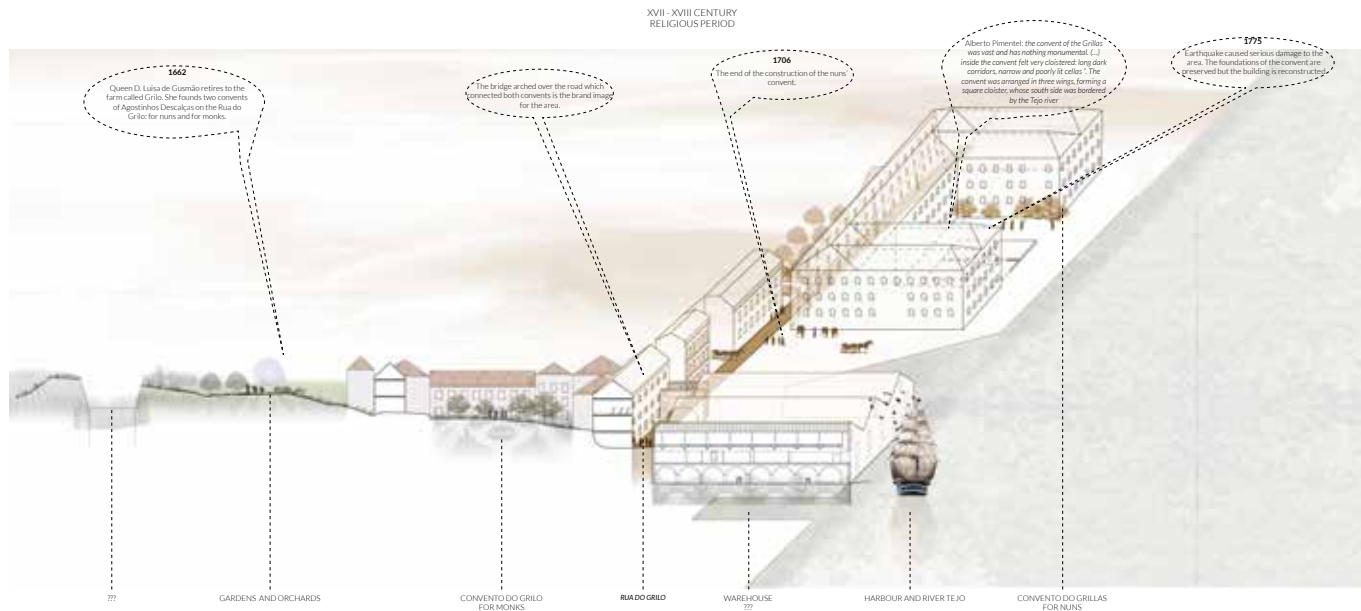

FIG. 4.18 Sections of the MMC location in Beato during its religious, industrial and decay phases, respectively / Monika Byra (H&A/TUD Master's student)

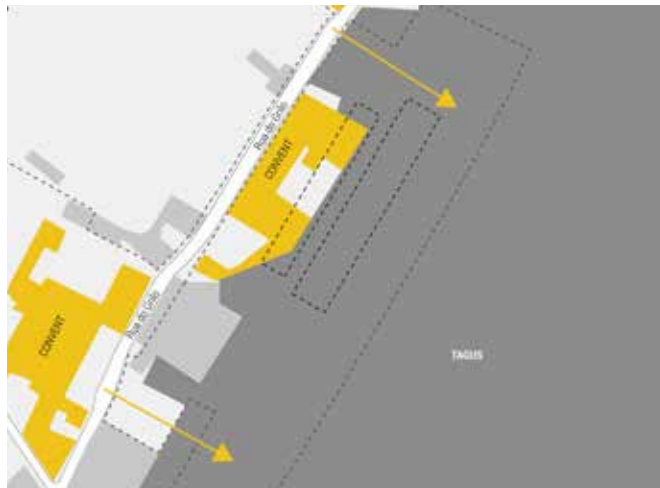

FIG. 4.19 Analytical map of the development of the MMC location in relation to the historical buildings and coastline / Ruben Klinkenberg (H&A/TUD Master's student).

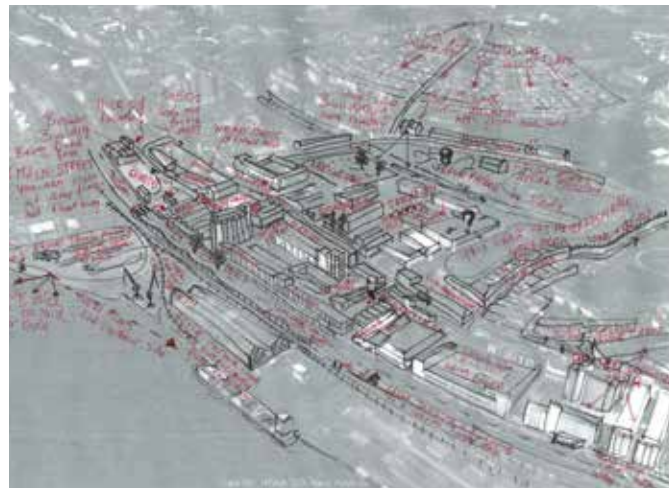

FIG. 4.20 Impression of the MMC location in the wider urban context, based on the 'soft atlas' method / Jochem Hols (H&A/TUD Master's student)

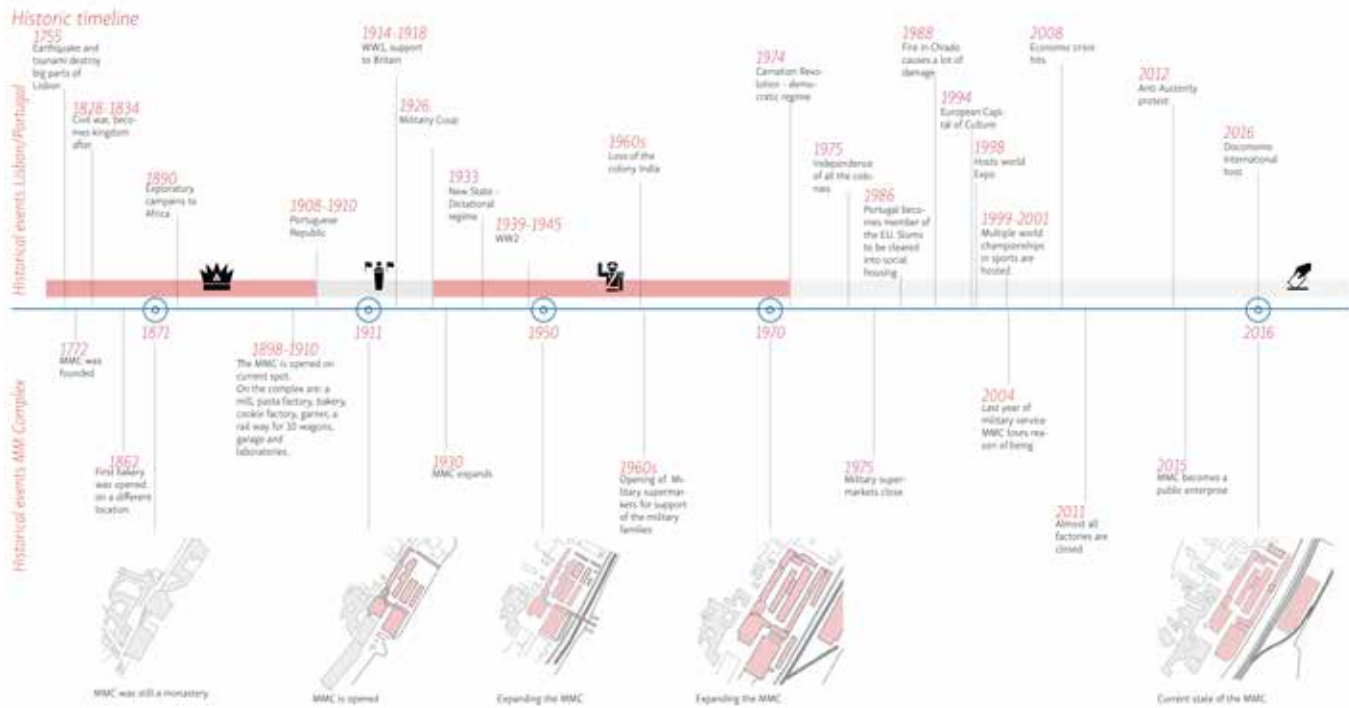

FIG. 4.21 A combined timeline indicating both relevant historical events and the topographical evolution of the MMC study site / Marlissa Trompert (H&A/TUD Master's student)

Over time, more land was reclaimed from the river on which additional buildings were constructed. [FIG. 4.18, FIG. 4.19]
 An aerial transportation cableway that connected the western railway station of Beato, via the MMC, to the wharf platform, has now disappeared. An enclosing wall separates the site from a modern traffic road and more recent buildings. [FIG. 4.20]

The H&A students defined four main construction periods punctuated by major administrative or cultural changes for the site. [FIG. 4.21]

They visualized the site's evolution in various ways of chronomapping by reworking historic photographs, old maps and drawings and making new schematic drawings.

Designing from Heritage – Strategies for Conservation and Conversion



Discovery Age: Parish Era



Military Era

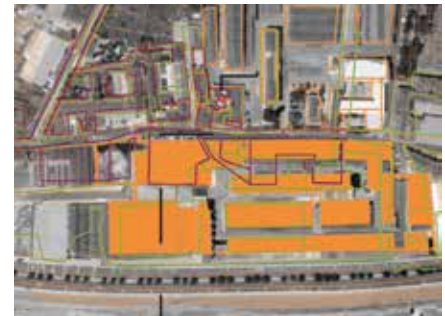

Decay Age: Concession Era



Map of Beato In Parish Era with convent De Grilos and the warehouse



3d visualization of elements around Building 01



3d Visualization overview Era's

FIG. 4.22 Page from the Cultural Value report on the MMC based on the group work's analysis of the street and adjacent buildings through time / Monika Byra, Anna Golubovska, Jochem Hols and Floor Hoogenboezem (H&A/TUD Masterstudents)

Some students focussed on the surroundings and the relation to the river. [FIG. 4.22]

Others centred their investigations on the buildings – either their functions or the social history. [FIG. 4.23]

Along with these general analyses of the site's evolution, a more detailed analysis is required to map the physical chronology of each heritage building which illustrates what part in the present situation dates from what period. [FIG. 4.24, FIG. 4.25, FIG. 4.26]



FIG. 4.23 Interior of the former bakery of MMC with the ovens faces with specially designed decorative tiles / Marieke Kuipers

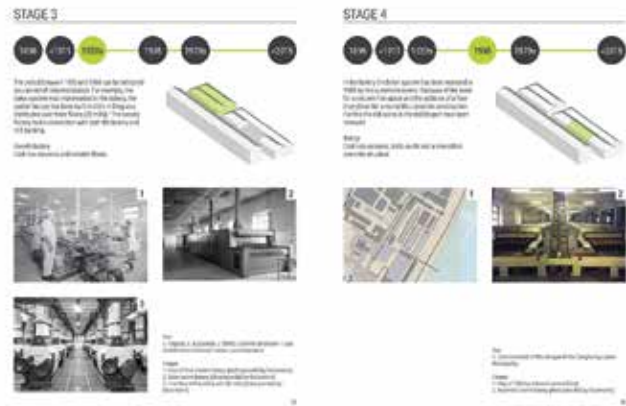

FIG. 4.25 Phases 3–4 of the evolution of the Bakery of the MMC / Ruben Klinkenberg (H&A/TUD Master's student)

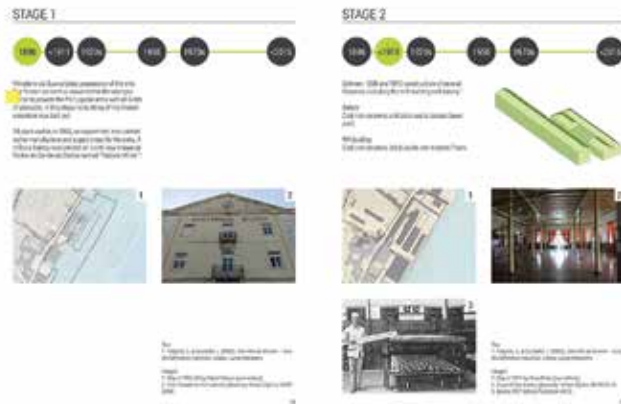

FIG. 4.24 Phases 1–2 of the evolution of the Bakery of the MMC / Ruben Klinkenberg (H&A/TUD Master's student)

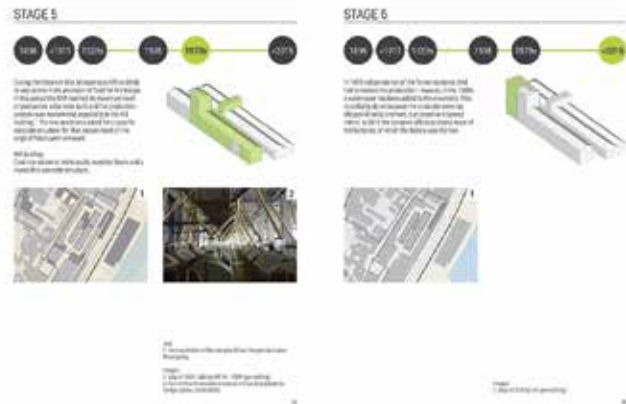

FIG. 4.26 Phases 5–6 of the evolution of the Bakery of the MMC / Ruben Klinkenberg (H&A/TUD Master's student)

CHRONOLOGICAL EVOLUTION (BAKERY AND COOKIE)

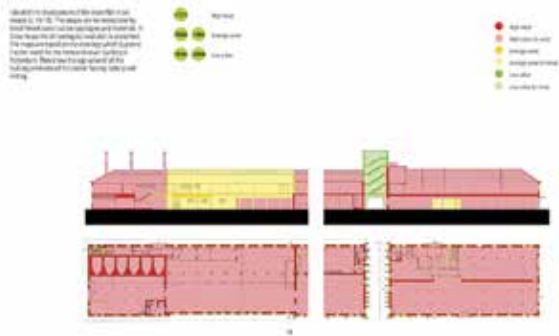

FIG. 4.27 Differentiation of relevant heritage values on the Bakery of the MMC-complex / Ruben Klinkenberg (H&A/TUD Master's student)

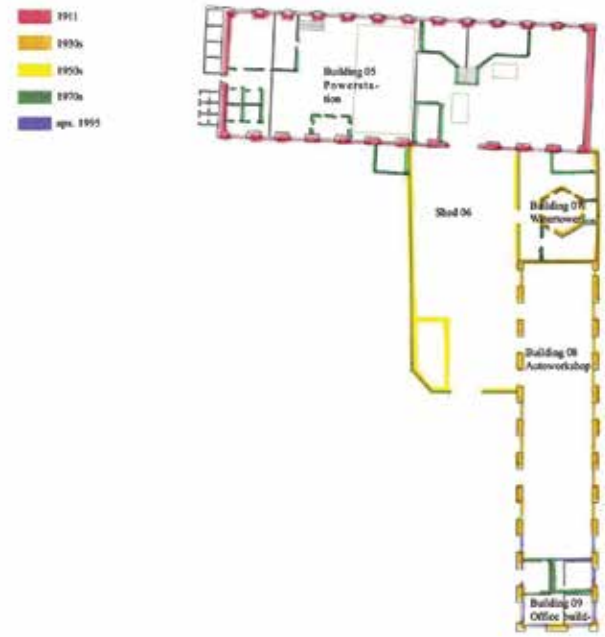

Fig. 1 Plan drawing of corner ensemble construction date



Fig. 2 Section drawing of corner ensemble construction date

FIG. 4.28 Section and plan of the corner ensemble of the MMC with indication of construction dates and key / Jessie Dong (H&A/TUD Master's student).

The mostly commonly applied method visualizes this data by colouring the current floor plans (of all floors), sections and elevations or axonometric drawings to designate the main phases of the construction. [FIG. 4.27, FIG. 4.28, FIG. 4.29, FIG. 4.30] It goes without saying that such drawings should always be accompanied by a key or by explanatory text boxes. A selection of contemporary or historical photographs and other drawings to the chrono-mapping can add valuable information and understand the various layers of time that have left their marks on the heritage building.

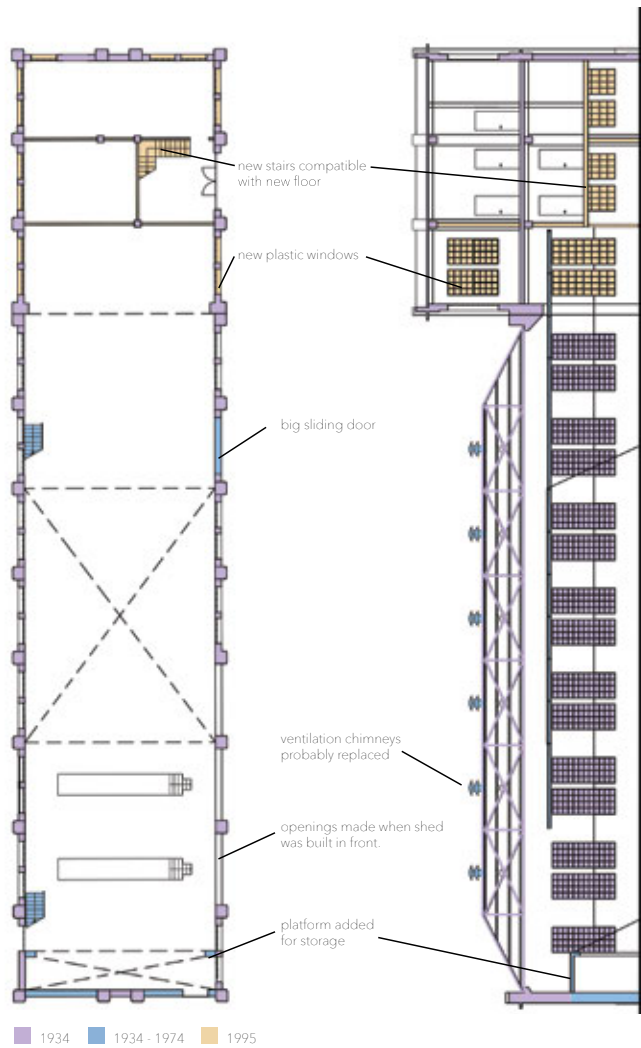

FIG. 4.29 'Chrono-map' of the car workshop of the MMC / Jeroen van Lier (H&A/TUD Master's student).

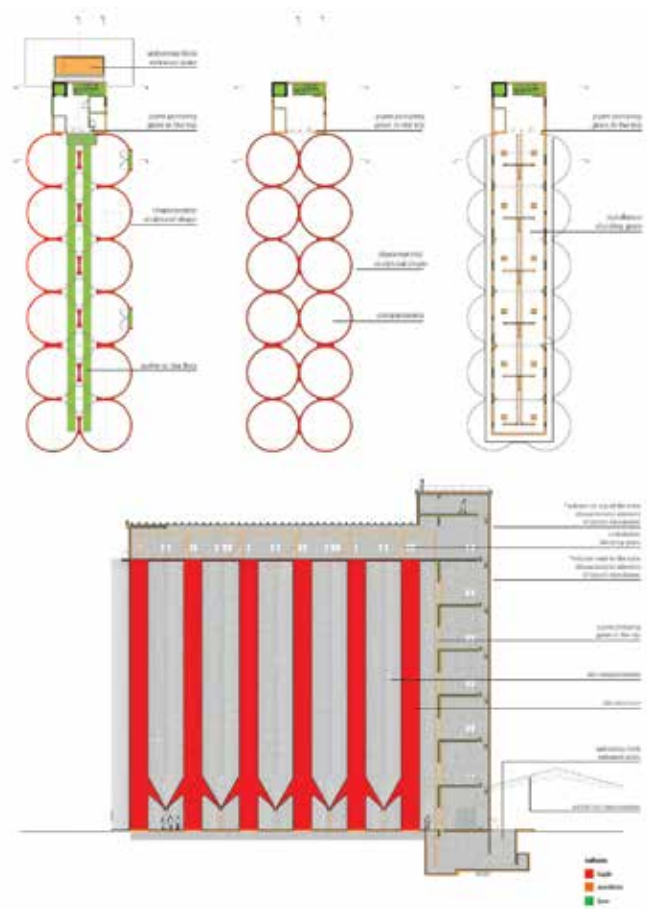

FIG. 4.30 'Chrono' and value mapping of the MMC silo / Daan Masmeyer (H&A/TUD Master's student)

LEARNING FROM ROTTERDAM



The captivating Van Nelle Factory at Rotterdam has, apart from its architectural qualities a high cultural and social historical value. The transparent character of its buildings with the remarkable tearoom as a focal point and their inherent materialisation and spatial structures are fundamental aspects of the complex, as is its visual relationship with the water, greenery and wider area. This highlight of Modern Movement architecture was already included in the Tentative List of the Netherlands for future nomination for the World Heritage List when the premises were vacated and put up for sale in 1998.

Anticipating later permit procedures, the Netherlands Department for Conservation had compiled, as an experiment, a Cultural Historical Reconnaissance Report.⁶⁵ This document was meant as a pro-active instrument to stimulate a quality-conscious process for adaptive reuse scenarios on the base of cultural identity. The report presented not only the opportunities and risks for conservation and development of the site, it also classified the main components of the complex into: 'to conserve', 'to sustain by preference, with alterations discussable' and 'replaceable' categories. The Reconnaissance Report presented ten points of departure and related recommendations for the adaptive reuse of the factory complex. These can still provide useful lessons for designers and other stakeholders who have to draft a suitable intervention strategy for highly sensitive heritage buildings:

- 1 what approach will be the most meaningful?
- 2 how to deal with the spatial-historical values?
- 3 how to deal with the larger factory site?
- 4 how to deal with the symbolic value of the buildings?
- 5 how to deal with the historical evolution of the ensemble?
- 6 how to deal with the transparency (of the building; from inside outwards, outside inwards and right through)?
- 7 how to deal with the diverse components of the complex?
- 8 how and where to position additions?
- 9 how to deal with the interiors?
- 10 how to apply technical modernisations?

Such pro-active guidelines for conservation permitting procedures were quite innovative at the turn of the millennium and coincided with further decentralisation in administrative responsibilities. In the case of the Van Nelle Factory, the results of the joint efforts to achieve a careful restoration and adaptive re-use have been internationally acknowledged, and culminated in the inscription on the World Heritage List in 2014.

⁶⁵ RDMZ & Kuipers 1998.

STEP 2: Value Mapping

The second step in the investigation procedure implies a site-specific identification and classification of typical features that can be distinguished in and around the heritage site in terms of construction, architecture and socio-cultural history. This is an extension of the process of anamnesis discussed in the previous chapter, but selects those aspects of importance to the cultural historical value of a place. The aim is to create a clearly structured and illustrated document that, like a map, will give a qualitative insight into the place and specificity of the particular heritage values of the investigated building or site.

If the historic building is registered or in the process of being listed as a protected monument, descriptions of varying detail are available of relevant stylistic, (former) functional, physical or cultural-historical elements that gave reason to its identification as a heritage site. The terminology employed in such descriptions and justifications is prescribed by architectural-historical, sometimes building-archaeological and legal jargon. Such formal motivations are however not always sufficiently informative for architects in charge of adaptations in the physical and spatial features of heritage buildings.

The value-mapping method introduced below is a further elaboration on the construction-historical analysis, but with greater focus on architectural and socio-cultural aspects. It requires the study of additional sources of information over and above the heritage building itself. For this purpose a special tool has been developed that will be explained later on.

IMPORTANT QUESTIONS FOR THE SITE-SPECIFIC MAPPING OF HERITAGE VALUES

What observations from the 'chrono-mapping' are particularly relevant for the presently visible time layers of the heritage building?

What are typical features of fabric, form, (former-) functions, spaces, volumes, sizes, colours, views, waters and/or greenery?

Where are these features still present on, in or near the heritage building?

What intangible aspects deserve to be noticed, both architecturally – such as daylight access and spirit of place – and cultural/social-historically – think of character and memories)?

Where and how are these aspects experienced?

What points of attention call for further investigation in relation to the evolution of the construction, uses, materials, et cetera?

Many parameters and criteria for the practices of listing and 'classical' conservation of built heritage are currently available. They indicate why a certain building is recognized as heritage, but they do not always specify what aspects are essential in order to keep it functioning in an ever-changing environment, in which a 'modern' and 'integrated' conservation approach (with partial reuse) is vital.

At least twenty different individual values have been discerned in the values-based approach to built heritage conservation. Not all of these necessarily relate to the physical fabric or architectural forms.⁶⁶

Unlike art objects in a museum, heritage buildings are always an intrinsic part of the built environment and apart from the influences of weather and changing tastes of occupants also subject to various usage requirements and building codes. Due to this physical reality, a heritage building cannot be treated exactly like other heritage objects. When charged with the task of maintaining a building in a good condition or retaining its full authenticity, design-orientated architects tend to be led by a preconceived intervention ambition.

⁶⁶ Orbasli 2008, pp. 37–63.

They are highly influenced by the brief of the client as well as the budget and time available for research to prepare an appropriate design. Many architects are so deeply influenced by the ‘form follows function’ approach of the Modern Movement and they find it difficult to inverse this motto for the sake of preservation (function follows form), or to take the extant fabric and features as the starting point for an ‘integrated’ design.

Because of the growing practice of ‘reuse’, and the ensuing, sometimes ostentatious, interventions committed under the name of Re-Architecture, a new educational tool is urgently needed to aid the evaluation process of a heritage building and to explicate its essential features from an architectural perspective in relation to fabric, form, time layers, space, light, use and facilities. These essential features are not necessarily all the same as the attributes that are identified in the ICOMOS Nara Document on Authenticity (1994) and that are later adopted as a base for the so-called ‘Nara Grid’.⁶⁷

Visualizing Heritage Values

Although the mainly descriptive ‘Nara Grid’ is certainly useful for ‘classical’ conservation, a more design-oriented valuation tool, which contains visual information as well, is needed for the current intervention practice which focuses on more aspects than authenticity alone. For this purpose, H&A has developed an experimental tool to identify the typical features of a built heritage site in its present state in direct relation their ascribed heritage values, presented by means of a matrix.⁶⁸

The first axis of this matrix, largely based on Brand’s six layers to which we have added three more, represents the built artefact. The other axis refers to core heritage values derived from Riegl’s dialectic value set, augmented by two additions. By filling the boxes of this matrix where relevant with text and images, and leaving non-relevant relationships blank, values are identified and related to tangible and intangible layers. This identification and revealed relationships, once established, become the basis for further understanding the value of a built heritage resource.

The shearing layers axis matches with those maintained in the anamnesis process, meant to analyse the physical *status quo* in an objective way, as described in the previous chapter on observation. To these are added three categories for the Surfaces in the interior, the Surroundings/Setting and Spirit of Place. These layers are already implicitly present in Brand’s model and the anamnesis process alike, but are made more explicit in the matrix in order to draw sufficient attention to them during the processes of observation and valuation.

The choice for Rieglian values (albeit in a different context than his) on the second axis is deemed applicable because they are independent from those terminologies usually found in current (inter-) national legislation and codes for heritage protection and conservation. It is precisely the antipodal positioning of ‘age’ versus ‘use’ or ‘newness’ values that informs the point of departure of the heritage architect for the next steps in the investigation and treatment in the form of conservation, adaptive reuse, or, at ultimate ends of the spectrum, reconstruction or demolition.

‘Rarity value’ has been added to those defined by Riegl, because this has become an important criterion for the justification of the eligibility of entire, or parts of historical buildings as monuments. Rarity is therefore a factor to be taken into consideration. Finally, an undefined column allows for the inclusion of other values that may be found to be essential to the building but cannot be accommodated in any one of the predefined heritage values.

⁶⁷ Van Balen 2008.

⁶⁸ The initial version of the valuation matrix was developed by Nicholas Clarke, Marieke Kuipers and Hielkje Zijlstra in 2016, building also on other methodologies to analyse architecture, and meant to be applied in the Master studios of H&A. The second version published here in this book is a further refinement based on our experiences in the education practice. Clarke & Kuipers 2017.

BRAND +	RIEGL +	AGE value	HISTORICAL value	INTENTINAL COMMEMORATIVE value	NON INTENDED COMMEMORATIVE value	USE value	NEW-NESS value	(relative) ART value	RARITY value [+]	OTHER relevant values [+]
SURROUNDINGS / SETTING [+]										
SITE										
SKIN (exterior)										
STRUCTURE										
SPACE PLAN										
SURFACES (interior) [+]										
SERVICES										
STUFF										
SPIRIT of PLACE [+]										

There is one crucial aspect that must be mentioned: Riegl valued heritage buildings in their entirety and in view of the radical choices between *konservieren* and *restaurieren*. Riegl did not explicitly address the option creating contemporary architectural interventions for adaptive reuse – a practice which has become frequent if not the norm – although he fully acknowledged the importance and consequences of keeping heritage buildings functioning. Perhaps even more important than aspects of authenticity for heritage conservation today, is the challenge for heritage buildings to meet current use requirements, whether these are existing, partly adapted or new functions.

Architects tend to interpret use value as the potential for (adaptive) reuse in the near future, while historians or conservationists often associate use value mainly with the still-visible features of past or present usages (and find

that these should, as far as possible, be sustained by an intervention). This difference in attitude requires that we seek the ‘tolerance for change’ based on the ‘cultural carrying capacity’⁶⁹ when we take the next steps of the investigation procedure will be set. Architects need to remain aware of these differences during this step of identification, valuation and the making explicit of detected heritage values.

The Heritage Value Matrix – presented here in a slightly revised version from that of the original experiment done in the H&A graduation studios – follows neither Riegl’s framework nor Brand’s model exactly, but offers the opportunity, in all its compactness, to aid the classification of relevant heritage values at various scales.

Features eligible for inclusion in the matrix include the range from whole heritage buildings and their surroundings and/or setting to the typical elements per layer and interior space. The matrix could, after the addition of other elements, also be applied to ‘green heritage’ or, if further detailed, to a richly furnished interior.

The matrix is specifically intended to guide students in detecting the essential qualities of the heritage buildings in their present state and to understand them better in relation to the historical evolution and not intended to be a all-encompassing tool. The method allows for a certain freedom in the way in which the boxes are filled: either text only, exclusively sketches or other images, symbols which cross-reference to other analysis documents, or combinations of all or any of these. The mapping should be exerted as objectively as possible, based on reliable sources of information and sincere observation without anticipation of future changes. It is an analytical method and does not provide for visualized hierarchies of values or features, a differentiation that is required by adaptive reuse investigations.

⁶⁹ Kuipers & Quist 2013.

Designing from Heritage – Strategies for Conservation and Conversion

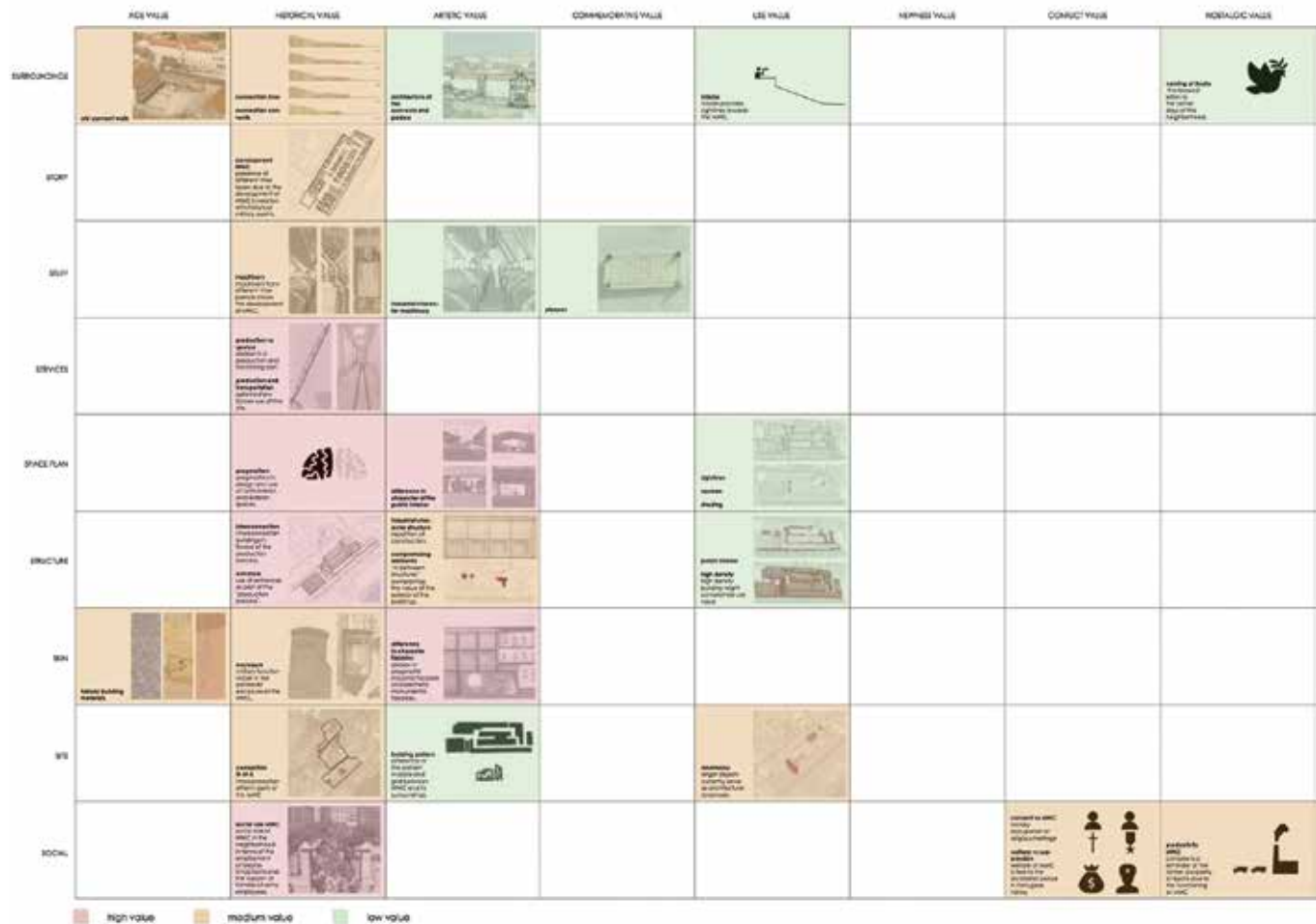

FIG. 4.31 The Heritage Value Matrix for the MMC, differentiated according to relevance along building layer, value and theme / Sophie Lok (H&A/TUD Master's student)

One way of organising the information contained in the matrix is by categorising it according to themes important to the heritage place. These can be represented by colours and sometimes combined in one box while still being justified separately. [FIG. 4.31, FIG. 4.32]

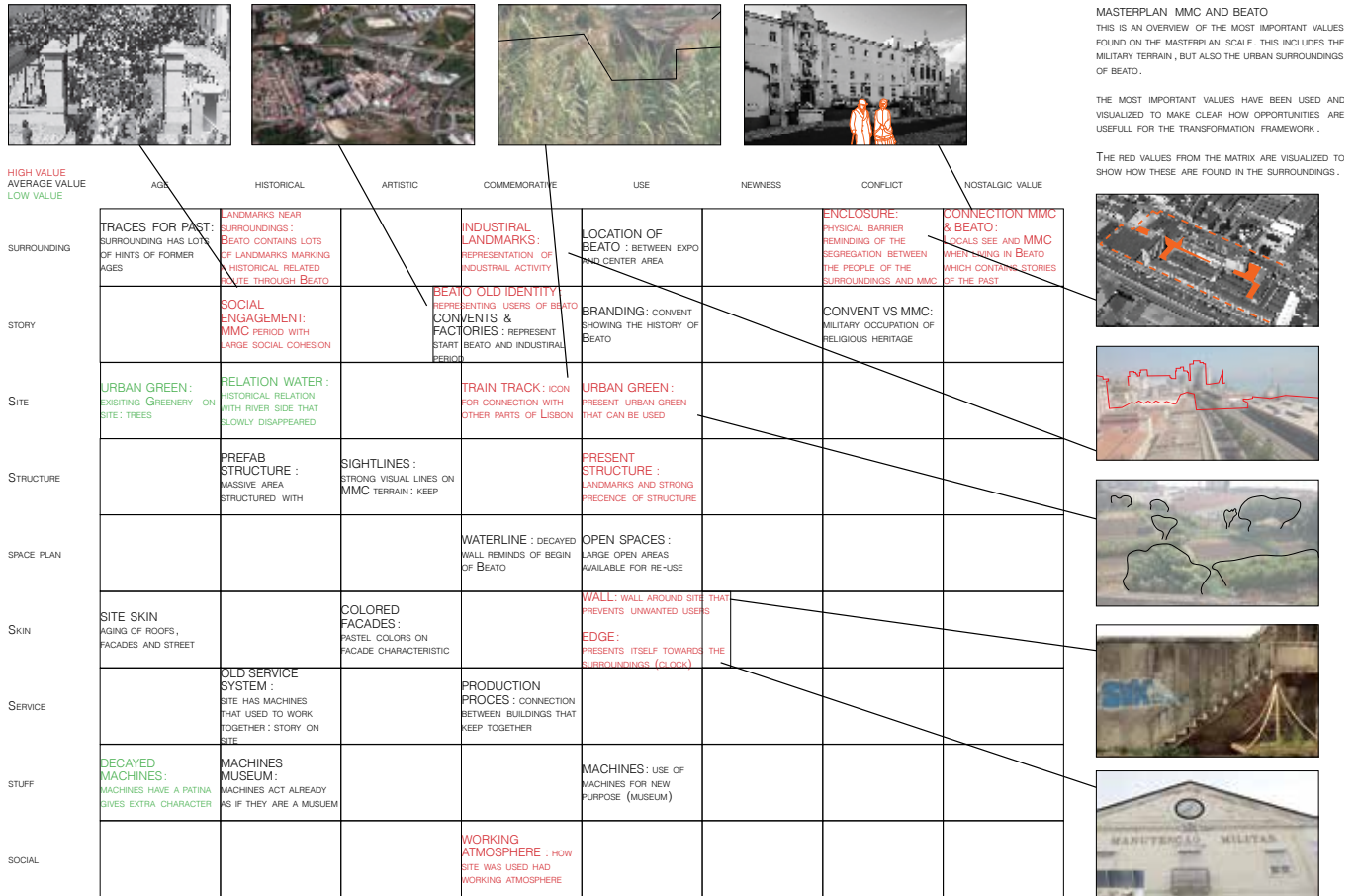

FIG. 4.32 The Heritage Value Matrix with differentiated coding of relevant aspects and appended explanation / Jochem Hols (H&A/TUD Master's student)

As already noted in the previous chapter on observation, supplementary methods directed at architects and urbanists, need to be developed and implemented in addition to those methods published in the 1960s and 1970s, for a proper analysis of the features of our more recently-built heritage. In this respect, the analytical drawings of the investigating

designers Els Bet and Heide Hinterthür⁷⁰ are very instructive as how to visualize spatial connections, patterns, contours, the interplay of dark and light, plasticity and greenery as well as colours and materials as typical heritage values of twentieth century settlements. [FIG. 4.33]

70 Bet & Hinterthür 2005..

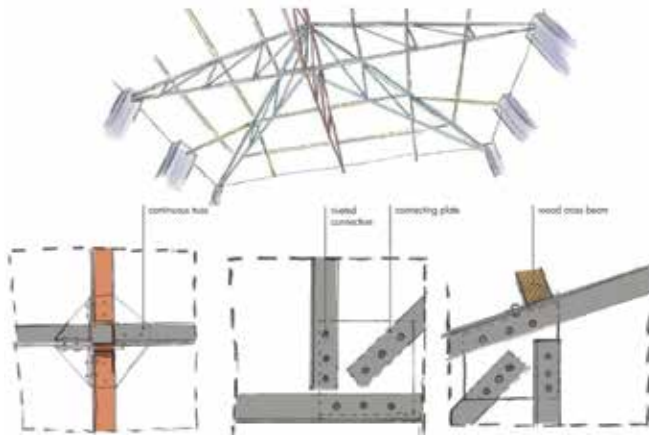

FIG. 4.36 Sketch of the technical details of the historical roof construction of the car workshop of the MMC / Jessie Dong (H&A/TUD Master's student)

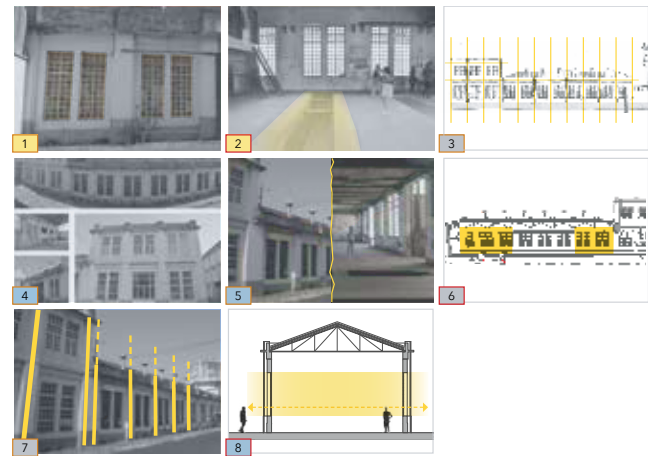

FIG. 4.38 Value Assessment drawing of the car workshop of the MMC indicating characteristic features / Jeroen van Lier (H&A/TUD Master's student)

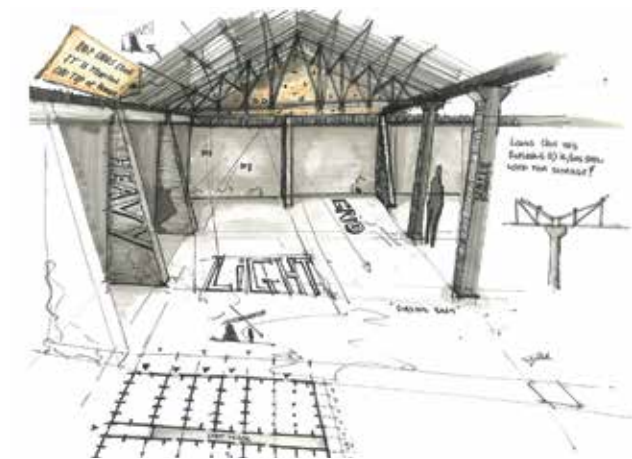

FIG. 4.37 Sketch of the construction of the warehouses of the MMC / Gert-Jan Post (H&A/TUD Master's student)



FIG. 4.39 Summary of main observations and value analysis of the former supermarket building of the MMC / Jochem Hols (H&A/TUD Master's student)

Thematic photo collages and other visual means are therefore very important to indicate the typical features of fabric, finishes and other relevant findings in situ.

[FIG. 4.36, FIG. 4.37, FIG. 4.38, FIG. 4.39]

These may also help in communication and differentiation during the next steps of our value-based design from built heritage process. Up to now we have explored. The next step is to synthesise and evaluate.

STEP 3: Mapping Levels of Significance

The third step of the investigation process involves a qualitative interpretation of the identified features and a critical review of the related heritage values. It aims at a substantiated differentiation in the levels of significance of both the general and the crucial heritage qualities as summarized in the previous steps of chrono-mapping and value mapping. Such a site-specific indication of high, medium or low or indifferent heritage values per part – not only in plan but also in section, space or façades – aids to steer decision-making for future interventions.

It is preferable that a multi-disciplinary distinction (building archaeological, architectural and socio-cultural historical) is made in this process to provide fair guidance for 'integrated planning and design' based on the present heritage values, but this is not always possible in the architectural education.

The intention of this step is to clearly mark the highest priorities for conservation, based on present heritage values and not aligned to future design ambitions. Although 'age' and 'authenticity' are frequently adopted as the distinctive criteria, particularly in the maps of building archaeology, other parameters also need to be taken into account for the critical and sensitive differentiation of heritage values in view of the anticipated intervention. In this way the distinguishing features can be made more pertinent in levels of significance than is presented by legal descriptions of heritage sites in local, regional or national registers of protected monuments.

The levels of significance can best be indicated on the value-matrix by highlighting aspects by use of a colour-code and adding brief explanatory texts to justify the differentiation made, such as a landmark function, rarity of certain elements, important visual relationships, spatial qualities or the special character of the place. Both tangible and intangible features can be prioritized as essential heritage qualities.

GUIDING QUESTIONS FOR THE QUALITATIVE DIFFERENTIATION OF IDENTIFIED HERITAGE VALUES

What are the essential qualities – spatially, architecturally, physically, historically, socially – that make the historical building(s) a heritage site?

What design-related features – fabric, form, (former-) functions, spaces, volumes, sizes, colours, views and/or greenery – can be regarded as key in supporting the heritage character of the site and why? Where are these located?

What intangible features contribute to the 'spirit of place', where and why?

What features are to be considered as of low or indifferent significance for the heritage character of the site?

What other observations are relevant for the differentiation in levels of significance for the heritage site?

In the current (inter-) national practice, no uniform key to distinct levels of heritage significance exists. We propose the use of the 'traffic light' key – with red for the high, yellow for medium and green for low heritage values – but other colour keys can serve just as well. [FIG. 4.40, FIG. 4.41, FIG. 4.42]

Therefore a very clear and consistent explanation of the interpretation of the differentiating colours in relation to the levels of significance is always required. The advantage of applying a colour coded grading is that it helps to deepen the analyses of heritage features and values as well as to communicate the interpretation to others. But for this they need to be clearly defined and justified. It is possible that this results in oversimplification – a potential disadvantage. [FIG. 4.43]

In general, however, the differentiation along levels of importance provides for quick insight into which the most important aspects are and aids in communication at an early stage of the adaptive reuse procedure.

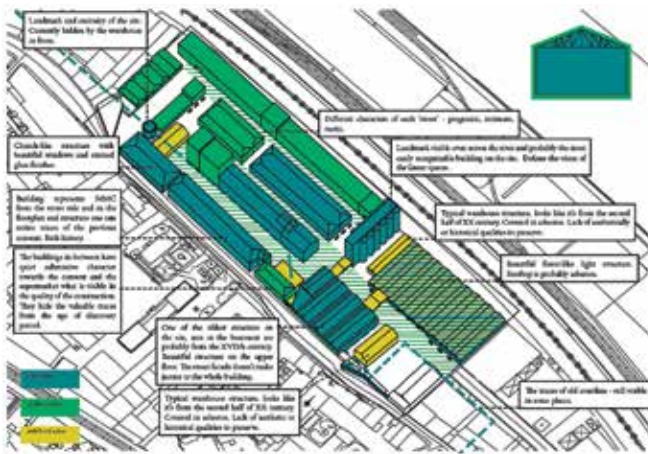

FIG. 4.40 Axonometric 'chrono' and differentiated value-mapping of the MMC buildings with colour key according to the Dutch guidelines / *Monika Byra (H&A/TUD Master's student)*

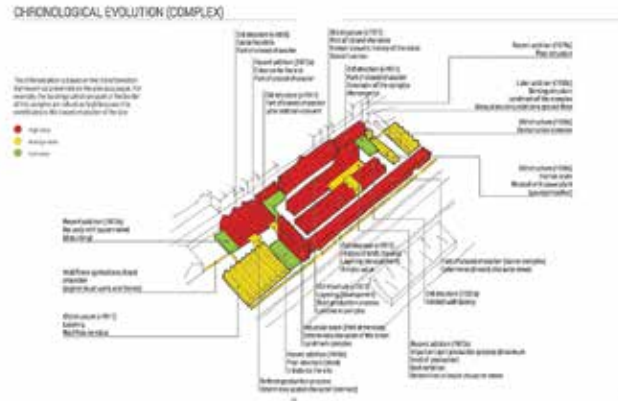

FIG. 4.42 Axonometric 'chrono' and differentiated value-mapping of the MMC buildings with colour key according to the traffic light system / *Ruben Klinkenberg (H&A/TUD Master's student)*

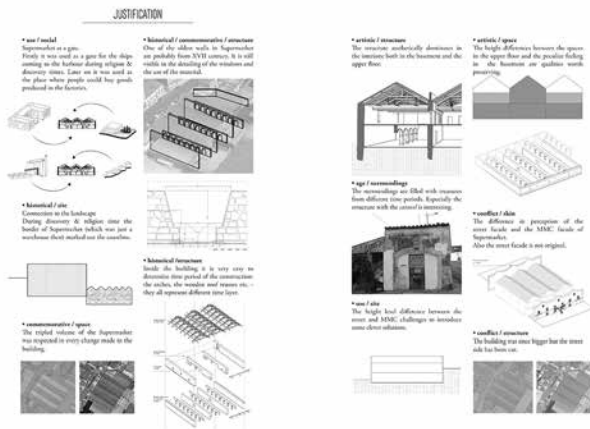

FIG. 4.41 Page from the Cultural Value report on the MMC, in particular the former supermarket building, based on the remnants of the old convent, with explanation of the historical evolution in three main periods by means of images and short texts / *Monika Byra (H&A/TUD Master's student)*

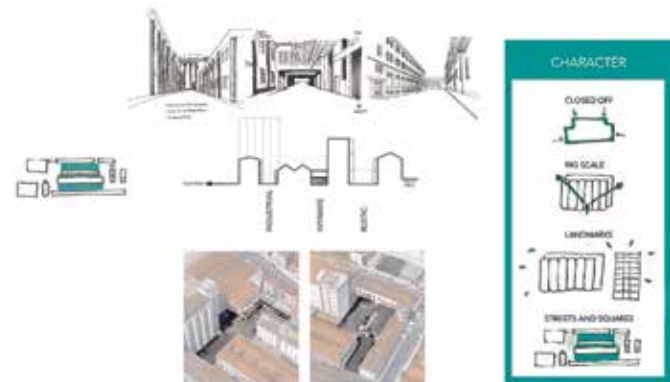

FIG. 4.43 Analysis of the relations of use and space plan and character on complex level of MMC / *Noelle Dooper (H&A/TUD Master's student)*

VALUE DIFFERENTIATION SUPERMARKET IN DRAWING



FIG. 4.44 Value differentiation applied to the former supermarket building of the MMC / Amela Rasidkadic (H&A/TUD Master's student)

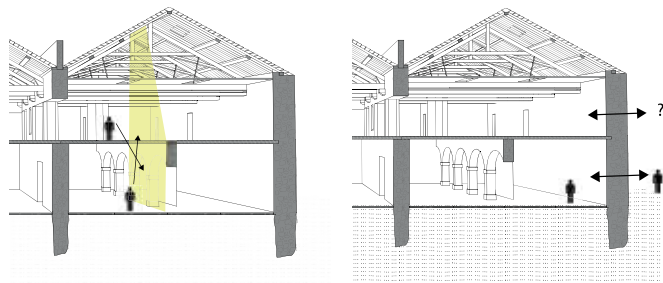

FIG. 4.45 Identified dilemmas concerning conservation and adaptive reuse issues / Amela Rasidkadic (H&A/TUD Master's student)

Beyond Established Frameworks

The Netherlands has a well-established tradition in geographical and prospective mapping. 'Principles and guidelines for the maintenance, repair and expansion of ancient buildings'⁷¹ have also been in existence for more than a century and, more recently, guidelines for compiling reports on the results of building archaeological research by specialists have seen the light of day. One such publication, the 'Guidelines for Building-Archaeological Research' stipulates that a textual and visually clear and verifiable distinction be made between facts, interpretations and value assessments. This in turn should be based on objective visual inspections and comparative analyses with similar aspects – such as typology, usage, architecture and cultural history– with the aim to identify the degrees of material authenticity and rarity of a historic building.⁷² [FIG. 4.44]

Any influence of users' or financial interests, technical deficiencies, possible considerations for future design et cetera should be avoided in such an interpretation. These guidelines instruct that the value assessment can only be based on the existing situation, as it is not possible to test or to verify the heritage value of vanished buildings or parts.

These instructions are primarily addressed at experts in building archaeology. Architects and students can learn from its systematic and evidence-based approach of investigation, documentation, justification and referencing. In addition to the two-dimensional maps proposed by the 'Guidelines', architects have to find ways to relay their weighted differentiation of features and values in axonometric drawings or architectural perspectives of exteriors and interiors with commentary notes on levels of significance (often high-, medium- and low, or, in extreme cases with an additional, negative).

⁷¹ Kalf/NOB 1917.

⁷² Hendriks & Van der Hoeve 2009.

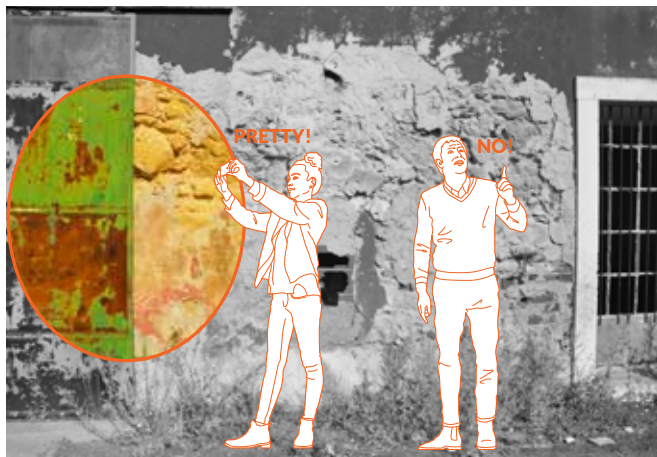

FIG. 4.46 The dilemma of conservation of decay (age value) versus repair (aesthetical newness value) / Monika Byra (H&A/TUD Master's student).

In practice, the highest value is generally attributed to the oldest parts of the fabric that have been detected, but age as such is not considered as the only decisive factor. The same is valid for 'originality' in relation to aspects of the architectural design.

Available charters and guidelines for built heritage conservation do not prove to be very helpful in setting out a framework for assessing architectural interventions when adapting heritage buildings to new needs. They speak of 'not disturbing' or 'not distracting' but hardly acknowledge efforts to enhance heritage values.⁷³ Instead, they require that new interventions should be 'reversible' in order to enable a possible return to a former state. However, it could be questioned if this rule of reversibility is appropriate with high-end architectural quality, mid- or long-term use and most importantly, demands of sustainability.

⁷³ Only the European Convention on Cultural Landscapes of 2000 (Florence Convention) does so.



FIG. 4.47 The potential conflict between reuse and upgrading the MMC buildings and the social community values in Beato brought about by the risk of gentrification / Monika Byra (H&A/TUD Master's student).

STEP 4: Defining Dilemmas

The last step of the investigation procedure is to distil the opportunities and obligations that need to be taken into account when preparing a strategy for adaptive reuse and (partial) conservation. The outcomes will inevitably pose certain dilemmas and problematic choices. Such dilemmas have to be 'mapped' in order to support the position of heritage architects with regard to conservation and transformation. [FIG. 4.45]

In this respect, the shortcomings and potential of current and desired use values might become considerations when deciding how to prolong authenticity and other essential heritage qualities as much as possible. [FIG. 4.46, FIG. 4.47]



FIG. 4.48 The interior of the former swimming pool at Roubaix, now converted into a municipal art museum while enhancing the original spatial qualities; as such an inspiring example of designing from heritage / *Marieke Kuipers*.

Several efforts, not only in the Netherlands, have been made to support decision-making in the inevitable process of transformation – for instance with regard to religious heritage⁷⁴ – but they are still based on the principle of reversibility. They mostly contain general recommendations for physical planning and guidelines for various forms of historical research. They are less explicit about how to judge the suitability of new proposed uses, the balance between old and new, and the quality of the new in architectural (re-)designs.

Although they often suggest that the architect in charge has sufficient experience and skills and knowledge of historical buildings and construction techniques, it is no longer a firm requirement in current Dutch legislation. Therefore, further

design-oriented frameworks need to develop how to prioritize heritage features. These must go beyond the already-established practices of building archaeology and architectural conservation. It has become more necessary than ever to train architects and students in value-based design from heritage. Currently, important dilemmas regarding architectural reuse of built heritage related to character, connection, comfort, control and costs. These demand different ways of thinking, designing and calculating⁷⁵ than is usually practiced. The search for an appropriate balance between old and new demands a willingness from the architect to ‘discover the assignment’⁷⁶ in an iterative process of matching detected heritage values with ‘do’s’, ‘don’ts’, ‘mays’ and ‘cans’ by means of research-by-design and scenario planning.

⁷⁴ RCE 2012–2013.

⁷⁵ Gelinck & Strolenberg 2014.

⁷⁶ Roos 2007.

CRUCIAL QUESTIONS FOR DETECTING THE OPPORTUNITIES, OBLIGATIONS AND DILEMMAS

What are the most essential qualities of the inherited site from the past in the present?

What is its cultural carrying capacity for the future?

What are the critical issues in case of reuse/alteration/extension with regard to character, connection, control, comfort and other obligations and opportunities?

What criteria are to be set for testing the cultural carrying capacity in scenario studies with regard to (re-)use and the continuity or change of fabric, forms, finishings, facilities, furniture, other architectural features – volumes, voids, views, materials and colours – in an equitable approach?

What technical, structural, environmental and societal requirements must be met and where might these cause possibly frictions with the essential heritage features?

Where are opportunities for possible extensions and under what conditions?

After mapping dilemmas and balancing values, the architect can formulate a position statement towards the obligations that come with the adaptive reuse of a heritage site. Together, these provide the starting point and trajectory for future design strategies, justified in full acknowledgement of both the irreplaceable heritage values and the need for cultural-historical continuity by means of carefully designed interventions. This concludes the four steps of analytical mapping for the diagnosis the architect should ideally undertake.

Today, technical and safety issues have generally become much more important than was the case when heritage buildings were constructed and so they require adaptation. This begs the question where and how? Many architects tend to consider the acknowledgement of various layers of time as an invitation to add a new layer to a heritage building through their design – be it modest, harmonious or contrasting.

Many building regulations impose up-to-date technical performance criteria for safety and energy savings, while ignoring the fact that heritage buildings have survived for a long time without these precautions, or that their replacement would imply a much higher waste of materials and embodied energy than could be compensated by a new structure.

Even if the function of a heritage building remains the same – for instance, a church, a town hall or a museum – the current requirements for use, accessibility, energy saving, safety, security, routing and exploitation demand that interventions be made. The challenge is how these needs can be best reconciled with the principles of architectural conservation and, effectively, with the continuity of the distinguished heritage features as essential elements in an integrated design for adaptation. [FIG. 4.48]

The four-step analysis method employed at H&A provides a clear-cut and objective process leading to the presentation of heritage features in a design-oriented idiom. This is increasingly needed for guidance in prioritizing preservation and, possibly, to provide a framework for options of change, particularly for the built heritage of the Machine Age.



FIG. 5.1 The entrance canopy of the Patrimonium Technical School (Ben Ingwersen 1956) after the conservation and adaptive re-use project in 2013 / *Raoul Suermondt*

5 – The Role of the Architect

This chapter analyses some aspects of the approach of our architectural practice, Wessel de Jonge Architects, when charged with the conservation, intervention and transformation of recent built heritage. The aim of this analysis is to formulate principle aspects, develop some general guidelines and come to conclusions that may contribute to a well-considered working method to respond to such tasks in practice.

Key to our approach is the extensive research we undertake into the historical, conceptual and technical backgrounds of a building – based on similar methodologies as those explained in chapters 3 and 4 – that serves as principle source for a ‘research-based’ design method. A strong interaction between research and design, and an engaged reflection on the original design intent are characteristic of this design process. Our primary aim is to make proper and inspired use of what is offered by the original building.⁷⁷ [FIG. 5.1]

5.1 – Strategy

Many architects of the Modern Movement – whether ‘functionalist’ or ‘rationalist’ in approach – designed their building to respond to a change of functional demands over time. As explained in chapter 2, some of them even took that to the point of accepting a limited lifespan when a building’s use was expected to be for a short term only. The architect Jan Duiker (1890–1935), one of the spokesmen of the Modern Movement, argued that whenever a building’s purpose had to change, the form would lose its *raison d’être*. In such cases, the building should either be adapted or demolished altogether.

They also claimed that their buildings were not designed as cultural artefacts for posterity, but rather that their intention was to address the ordinary. Where these points of departure led to intentional design decisions, this implies a particular strategy for the preservation of such buildings and explains why specific choices for their conservation and/or transformation are made.

⁷⁷ Parts of this chapter have been based on chapters Henket & De Jonge 2010a; De Jonge & Henket 2010a..



FIG. 5.2 The main function of the Dam Palace (Jacob van Campen 1665) is as cultural asset rather than to accommodate any viable economic use / *Wim Ruijgrok*

When heritage values exceed the functional or economic need to keep a building, preserving it can result in a paradoxical situation. The conservation and adaptive reuse of Jan Duiker's 1928 Sanatorium 'Zonnestraal', originally designed with a limited lifespan in mind, is a case in point here.⁷⁸ When considering the building's preservation we were faced with a dilemma.⁷⁹ Were we to pay heed to the ideas of the original designer and allow it to go to ruin limiting ourselves to its comprehensive documentation or adapt the structure instead? Because of the exceptional quality that we now ascribe to buildings like 'Zonnestraal' and our need to preserve them in some form or other, the somewhat idiosyncratic intentions of the original designer are often bypassed.

⁷⁸ On Sanatorium 'Zonnestraal' cf. ch. 2, note 7. The references made to the restoration project for 'Zonnestraal' concern the Main Building, which was the first phase thereof. De Jonge & Meurs 2010.

⁷⁹ Henket and De Jonge 1990.



FIG. 5.3 Rather than being inhabited, the Rietveld Schröder House (Gerrit Rietveld 1924) today serves as a house museum / *Wessel de Jonge*

However, if we pursue this line of reasoning, the function of the structure will in future not only be utilitarian, but be primarily cultural, scientific and emotional. From that point onwards, such a building's main function is as a cultural asset, in other words a 'monument'. It may even be turned into a museum. Our efforts to restore the original architectural features of 'Zonnestraal' to a high level of detail clearly align with this perspective.⁸⁰

Such starting points have been regarded as being suitable for some other exceptional heritage buildings, such as the Dam Palace (Jacob van Campen, 1665) or the Rietveld Schröder House (Gerrit Rietveld, 1924), which was reopened as a museum house in 1987. However, for most heritage buildings, a more viable type of use is required in order to make their preservation and adaptive reuse feasible. [FIG. 5.2, FIG. 5.3]

⁸⁰ De Jonge 2004; De Jonge & Henket 2010b and 2010c.

Approach

In order to satisfy the need for historic continuity, the cultural value of most built heritage can only be safeguarded through physical preservation. A hierarchy of intervention strategies exist for application to heritage buildings selected to be physically retained. The most extreme option is to revert to a building's original state. An alternative approach could be to allow later transformations to be retained if these made a new conceptual contribution to the original building. Components that do not contribute to the concept could possibly be demolished. In practice one is obviously soon confronted with combinations of these forms of intervention, as demonstrated by the preservation and conversion of the Van Nelle Factory in Rotterdam, where some later interventions have been kept, others have been reversed and some have even been newly added in order to allow for a new use.⁸¹

If we accept the fact that the safeguarding of a heritage building mostly requires that it must be granted a second lease of life, then its adaptive reuse must be economically viable even if the artistic value of the original concept was the main reason to retain a structure. This implies that intervention in the building is likely to be necessary. If the original concept is seen as an essential heritage quality, the question regarding which and how many alterations can be allowed without losing a building's essential qualities arises. This obliges us as architects to ascertain the essence of 'the original' and to establish within this essence the limitations to which the building can be stretched when adaptation is inevitable.

'The original'

The question then is: what is 'the original' actually? The building is rarely that which the architect originally designed, or what is contained in the construction drawings, because of changes undertaken during construction, later adaptations to respond to functional needs or cultural preferences such as fashions, and maintenance measures. Historic building surveys tend to provide some clarity here, even if – given that there are various aspects to originality – they contribute little more than an as fitting an interpretation as possible.

The Venice Charter of 1964 – swiftly adopted by the then newly formed ICOMOS – provides criteria for the restoration of buildings. This document states that a heritage building should meet the benchmark with regard to originality of the design, materials, workmanship and setting. To describe this, ICOMOS uses the multi-interpretable term 'authenticity'. However, with Modern Movement buildings, the concept of the ideal and its manifestation in built form are equally essential to the built object. We therefore decided to add two additional guiding principles when we commenced with the restoration of Sanatorium 'Zonnestraal', a project that has been a guinea pig for modern heritage preservation in the Netherlands since the 1980s. These are the originality of the idea as well as the form.

The key question in each and every intervention decision is whether the priority lies with the preservation of the original idea, or the conservation of the original substance. This establishes a hierarchy of principles for conservation. Experience has taught us that such theoretical concepts are useful to give direction to decisions, but the practicalities are mostly more complex and therefore demand some subtler distinctions.

⁸¹ De Jonge, 2005.

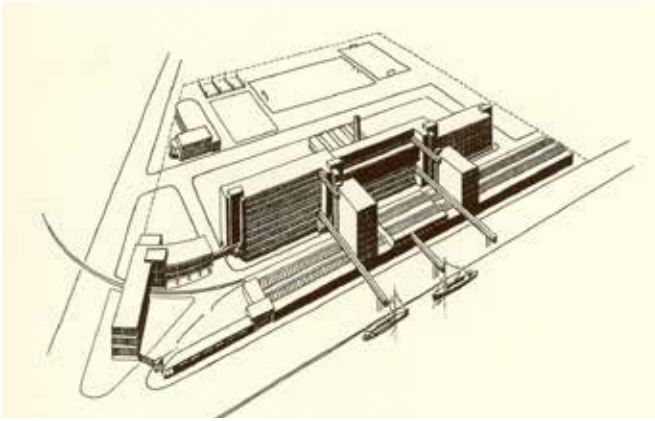

FIG. 5.4 The 1926 masterplan for the new Van Nelle plant guided the factory's construction until 1931 / *Brinkman & Van der Vlugt Architects – Het Nieuwe Instituut*

Original state

The unravelling of subsequent phases of construction takes a central place in almost every historic building survey report for traditional architectural heritage. For Modern Movement heritage such surveys are primarily focused on the first phase of construction, denoted as the 'original state'. But buildings were adapted or extended much more readily in the twentieth century than before, usually for reasons arising from everyday use and upkeep and often without regard for an architectural or cultural intention. After all, as we have seen, the Modern Movement aimed at providing ordinary buildings rather than cultural icons. A basic principle for the assessment of subsequent interventions is whether these were conceptual or simply pragmatic in nature. The decision to revert to the original state is a consequent step when later alterations do not represent any special historical or cultural value. This was the case with the Main Building of 'Zonnestraal'.



FIG. 5.5 An aerial photograph of the Van Nelle Factory from the 1950s, the original extent of the project highlighted / *KLM Aerocarto – Gemeente Archief Rotterdam – overlay by Wessel de Jonge Architects*

Construction of the Van Nelle Factory commenced in 1926 and the first building was completed in 1928. The Dispatch Building of 1931 is taken as the last building to be part of the 'original state', as this was the last component of the ensemble to be realized as originally intended and documented in a master plan. For Sanatorium 'Zonnestraal' a similar rationale was followed. The extent to which the original architect – guided by the original architectural concept and within a limited timeframe – determined the character and particular qualities of the building is the deciding factor when determining the original state. [FIG. 5.4, FIG. 5.5, FIG. 5.6]



FIG. 5.6 The completion of the Dispatch Building in 1931 marked the last phase of implementation of the masterplan and is therefore part of the original state. The building was restored in 2003 / *Fas Keuzenkamp*

5.2 – Research

It goes without saying that all acceptable approaches require careful preparatory research –continued throughout all subsequent phases – to provide guidance to decision-making and implementation. When the first professional restorations of pre-World War II Modern Movement architecture were hesitantly initiated around 1980, the need for a general strategy for the preservation of this architecture became apparent. Yet, at the time hardly any references presenting a methodology on how to perform historic building surveys of modern heritage were to be found.

The availability of external sources like architectural drawings and new sources such as film footage and photographic material had increased over the course of the twentieth century. Because of the abundance of this reference material and the availability of original plans and other reliable descriptions of buildings to be restored, investigating the actual buildings did not seem to be the most obvious first step.

The characteristics of these structures also still appeared quite familiar and so, technically speaking, the path to preservation seemed to be fairly self-evident. It seemed that the Modern Movement’s buildings were already documented to such a large extent and in such manner that restoration on the basis of this pre-existing documentation alone would be straightforward.

The realisation that the physical object itself is also an indispensable source of information, in other words, acknowledging that the materiality of Modern Movement heritage also possesses a historical value only dawned later. It was the lengthy restoration process undertaken at ‘Zonnestraal’ that allowed us to explore and learn that physical research into the buildings themselves is just as necessary as the investigation of archives.⁸²

New technologies

The availability of technical knowhow determines a designer’s ability to realize his ideas. During the period between the two World Wars, architectural practice was fundamentally still a traditional craft. The ideals of the Modern Movement with regard to the industrialization of construction processes could not be realized at will, but was limited to what available construction techniques allowed for. However, the ambitions of the designers of the Modern Movement stimulated innovations in construction and installation technologies.⁸³ The novel uses of materials and new construction methods that were developed at the time were usually still experimental.⁸⁴

⁸² Further sources for the Historic Building Survey for ‘Zonnestraal’ included archival drawings, reports, correspondence and other documents, as well as photographs of the works, films and oral testimonies that are mostly unavailable for older buildings. De Jonge 2006, 2010a, 2010b, 2010c.; De Jonge & Henket 2010a.

⁸³ See, for example, Van Loghem 1932, pp. 196–197.

⁸⁴ The most significant exception was the use of concrete for constructive purposes, which became more commonplace from the late nineteenth century on and was regularly discussed in architectural manuals around the turn of the twentieth century, as in Sanders 1907. See Van Eldik 1987, pp. 18–25.

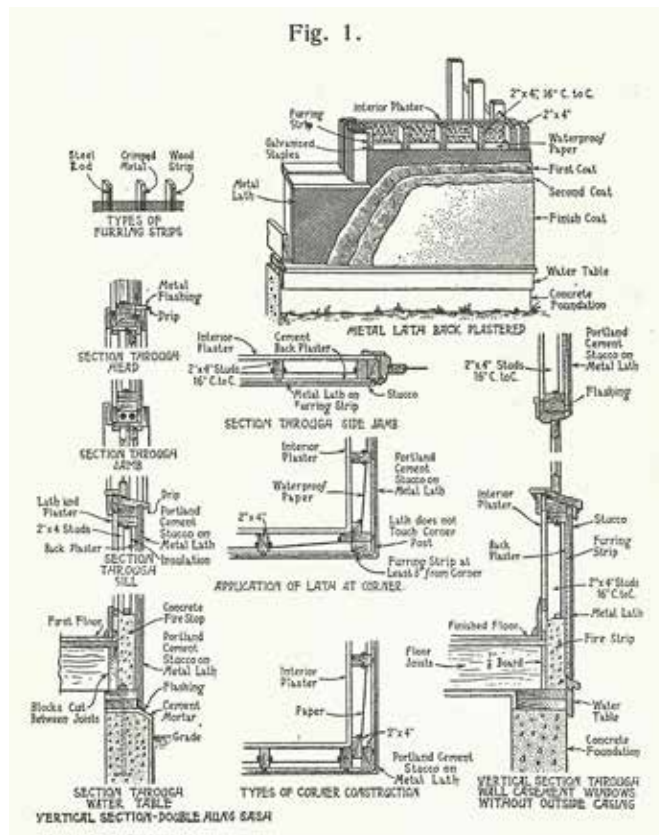

FIG. 5.7 An American system for light façade construction was copied with slight modification for the Sanatorium 'Zonnestraat' buildings – the wooden studs were replaced by steel ones. Structural engineer Wiebenga had already proposed this alteration when he described the original system in 'Gewapend Beton' in 1926 / source unknown

If we want to properly understand the ideas that underlie a design, we need to gain a reliable insight into the state of technical expertise at the time an architect worked on a building. The degree to which the architect succeeded in implementing his ideas should also be assessed. This is a usual feature in historic building surveys, but a complication when dealing with twentieth century buildings is the great quantity of new industrially produced materials that were being developed at the time.

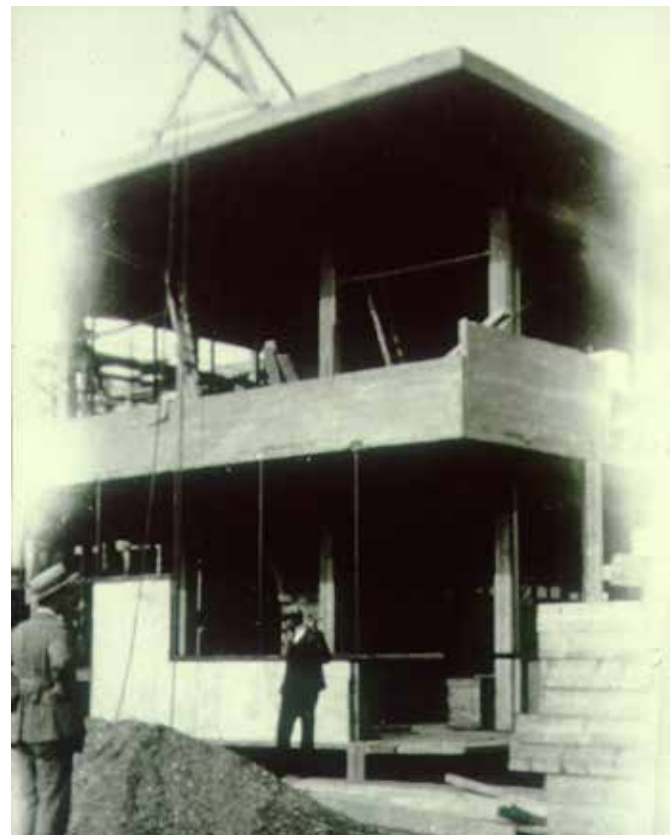

FIG. 5.8 A photo taken in 1927 during construction, discovered in the archives of a (then) junior Clerk of Works, shows the positioning of the metal studs and the first tests to create a spandrel by plastering over a metal lattice (labelled as 'lath' in FIG. 5.7) / Jan Piet Kloos – Wessel de Jonge Architects

These products were being brought to market at a steadily increasing speed and sometimes disappeared again just as swiftly. One can correctly assume a certain standard knowledge of construction techniques for builders in the nineteenth century, to be found in construction manuals. From the interwar-period onwards, the construction knowledge and techniques employed were determined more and more individually.



FIG. 5.9 'Destructive research' of an original part of the spandrel revealed wooden battens horizontally applied to the metal lattice (labelled as 'lath' in FIG. 5.7), which were not documented in any of the original drawings / Wessel de Jonge Architects

The lack of referential knowledge about 'modern' materials and techniques still makes it difficult to evaluate how progressive those architects were. [FIG. 5.7, FIG. 5.8, FIG. 5.9]

The knowledge and experience of any other consultants who were involved in the design and construction process is also of interest. For the fragile architecture of the Modern Movement, building physics and climate control were not

only highly important on a technical level, they were deemed conceptually essential by the architects.⁸⁵ It is often assumed that technical solutions presented in the work of Jan Duiker and other Modern Movement architects – which by current standards may be unsatisfactory – stemmed from the ignorance of the designers. However, when one compares design concepts to technical knowhow, it turns out that many of them were much better informed about developments and potential pitfalls in construction technology and climate design than we tend to assume.⁸⁶

Practice has taught us that we must explore the link between the materialization of buildings and the design approach of their designers. For instance, it became evident that Duiker's buildings often served as a testing ground for novel construction techniques, an innovative use of materials and experimental building services. The sometimes-stark contrast between the prevailing immaculate image of the Modern Movement's buildings and the imperfect finishing with the evident traces of handwork that we encountered in reality, makes their innovative character even more strikingly obvious than all the tomes that have been published about them. This realisation exercised a growing influence on the restoration of 'Zonnestraal' and ultimately led to a more traditional approach being adopted in the finishing of both its interior and the exterior.

⁸⁵ Henket & De Jonge 1990, pp. 28–29; De Jonge 2006, pp. 27–45.

⁸⁶ Tomlow 2006.



FIG. 5.10 The restored entrance lobby with remade 'expensive' linoleum and handmade cement plinths. The original linoleum was intended to reduce the noise of footsteps and the cement plinths were employed to save budget. During restoration the cement plinths had to be remade by hand at high cost / *Jannes Linders*

Interpretation

The most novel aspect of our research practice however is the viewing of uncovered facts in the light of both the original design concepts and the original client's motives. If the original inspiration for the building is rooted in its functionality, then the building cannot be understood without knowing its purpose and the motives of the client and the architect. The research should therefore extend beyond scouring sources to establish facts; it should also aim at unearthing the conceptual roots of the original building.

We consequently probe further than the manifest form of a building and attempt to penetrate the design rationale on which it was based in order to gain insight into the building's underlying logic.

The client's position and the prevailing socio-economic climate could have exerted considerable influence on the design decisions. At 'Zonnestraal', for instance, the influence of the client's socio-economic background came into sharp focus through our study of the 'Zonnestraal' Association's archives.⁸⁷ Had we understood the minimal materialization and frugal quality of 'Zonnestraal' only as the product of a limited budget, this could have led to choosing more durable replacement materials during the restoration.

⁸⁷ As 'Zonnestraal' was financed from funds collected by the General Diamond Workers Union, funding was in extremely short supply.

But, because of our new understanding of the intended temporariness of the buildings – explained by the then current perspectives on the fight against tuberculosis and aftercare for its victims as well as the way the project was funded – we chose for a different approach aimed at respecting the original materialization.⁸⁸

As mentioned before, the innovative ideas of ‘Zonnestraal’'s original designers greatly influenced the preservation of the former sanatorium’s buildings but, in turn, the material findings from field research also contributed to a proper understanding of the original conceptual principles. This illustrates the strong interaction between design philosophies and materialization. [FIG. 5.10]

Evaluation

The process of interpretation as described above is inevitably more subjective than the preceding steps, which are focussed on establishing facts as objectively as possible. Generally accepted guidelines, such as the Venice or Burra Charters, or DOCOMOMO’s Three Dimensions of Modernity,⁸⁹ make it possible to assign a justifiable value to all the aspects, components and details of an existing building.

It is important that this be recorded to allow for discussion at a high level of abstraction with heritage authorities regarding the value that should be attributed to distinct components. In this way we can facilitate early consensus on several main thrusts of an action plan without first investing in a detailed restoration or transformation plan.



FIG. 5.11 A map from the 1998 Cultural Historic Reconnaissance for the Van Nelle Factory indicating the ‘opportunities’ and ‘challenges’ for redevelopment. This was composed to provide for a level playing field for commercial parties on which to base their respective bids / *Rijksdienst voor het Cultureel Erfgoed*

It may however sometimes be advisable to steer a redevelopment process more purposefully by indicating in advance where transformation should preferably take place and where careful conservation should be guaranteed. This can be achieved by designating and mapping out opportunities (for transformation) and challenges (to monumental values). This can have a stimulating effect, especially when redeveloping a building for the commercial market, as was the case with the Van Nelle Factory. An analysis of challenges, opportunities and obligations can establish a bridge between historic building survey and design. This may however be even more subjective than the results of the architectural-historical evaluation.

[FIG. 5.11, FIG. 5.12, FIG. 5.13]

⁸⁸ This consideration is just as relevant for the client of the project, who must be willing and able to bear the maintenance-related consequences.

⁸⁹ This perspective was introduced by Catherine Cooke and Ivor Richards. Cook & Richards 1993.



FIG. 5.12 The floor plan of the Patrimonium Technical School reworked into a historical atlas for the Historic Building Survey Report in 2011, indicating various levels of cultural historic value: high (red), limited (amber) and indifferent (green) / Suzanne Fischer

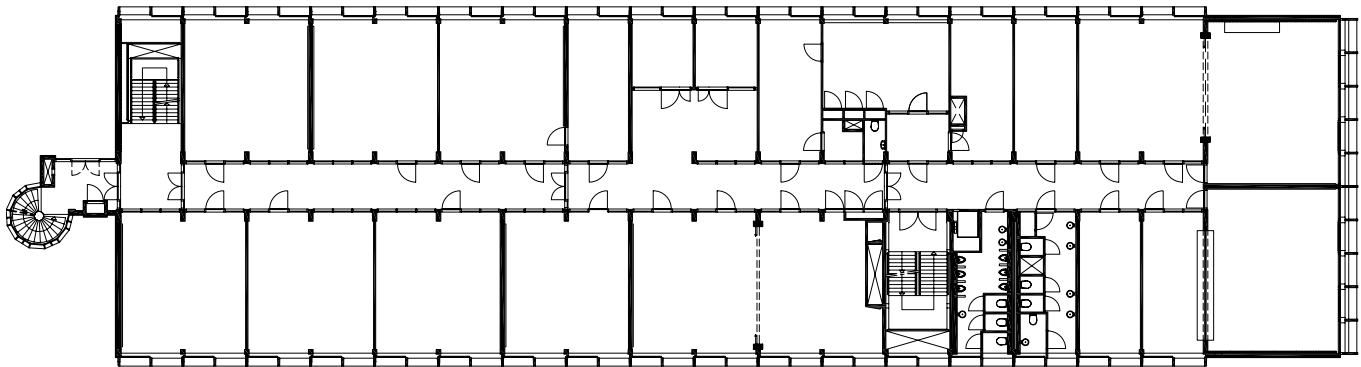

FIG. 5.13 A typical floor plan of the school building in use as a grammar school today; the previously existing floor plan is shown in FIG. 5.12 / Wessel de Jonge Architects, Rotterdam

Reporting

Reporting this kind of historic building survey requires departing from the traditional template on a number of points. Because of the importance of visual materials in the majority of studies, our reporting is as far as possible presented on the basis of visual material, rather than in writing. We usually map out our evaluations of the various components and zones in an easily recognizable form in a 'historical atlas' of plans, elevations and cross-sections. We employ a colour coding analogous with traffic lights: red demands extreme caution because of a high historic value, often due to the presence of original components and materials, or elements that reflect the original design concept very strongly; amber calls for proceeding with caution, often because there may be historical assets at stake that could not be investigated sufficiently or because valuable modifications from a later phase have been identified; green indicates components of indifferent value, usually later additions or sections that have been radically altered. Blue is sometimes added to indicate a category of components that interfere with the historical perception of the building and should by preference be removed. As explained in the previous paragraph the historical atlas reflects somewhat

subjective opinions to facilitate the discussions on the proper approach for a heritage building. It is therefore important that the positions taken are well substantiated.

When consensus has been reached, the historical atlas can serve directly as an underlay for the design team during the consequent phase of planning and design. Necessary interventions should preferably be designed in such a way that the highly valued zones of a building are avoided. The historic materials and finishes are recorded in technical specifications using classifications that are currently in use in the construction industry. This information can then serve as a starting point for the architect involved in the restoration design. This pragmatic approach is often a necessity, because built heritage often has to be redeveloped in a field of tension involving cultural preservation, commercial interests, sustainability and ever changing rules and regulations, which calls for swift decision-making.⁹⁰

⁹⁰ For some reason, time constraints seem to occur more frequently when redeveloping recent heritage buildings than traditional ones. There is no proper explanation available for this.



FIG. 5.14 The HUF Building in its original state around 1953 / *Gemeente Archief, Rotterdam*



FIG. 5.15 Due to the lack of exterior sun screens, tenants of the HUF Building's office floors soon covered the windows to block out direct sunlight and added ventilators in order to minimise the excessive overheating of the interior spaces / *Gemeentewerken, Gemeente Archief Rotterdam*

The architect as researcher

A historic building survey can be tackled by an independent researcher or by the architect in charge of the restoration and/or adaptive reuse project. There is something to be said for both options.⁹¹

Architectural historians and historic building surveyors are likely to be much better trained to perform investigations of archival material and buildings in a professional and scientifically correct manner. The benefit of the independent position of such a researcher is the fact that the research results tend to be safe from the influence of intended interventions. This reporting is likely to provide in-depth historic interpretation and to have a high standard of objectivity.

Yet it is reasonable to assume that architects are able to place themselves in the position of the original designer because of their practical design experience. They can establish a line of reasoning that could explain certain design choices embodied in the original structure. An expert without any design experience may overlook this. This means that an architect acting as researcher – even when not engaged in the restoration project – may come up with fresh and different interpretations.

One step further, is entrusting the historic building survey to the architect in charge of the project. The rather obvious risk here is that the architect's interpretation and presentation could be influenced by the intended interventions. Although a degree of design experience can indeed be very helpful in unravelling the mysteries that are sometimes attached to the buildings we deal with, the dialogue with other heritage experts, including architectural historians and heritage authorities, creates a dialectic arena that is indispensable in arriving at adequate conclusions for the next phase of planning.

⁹¹ Meurs 2016.

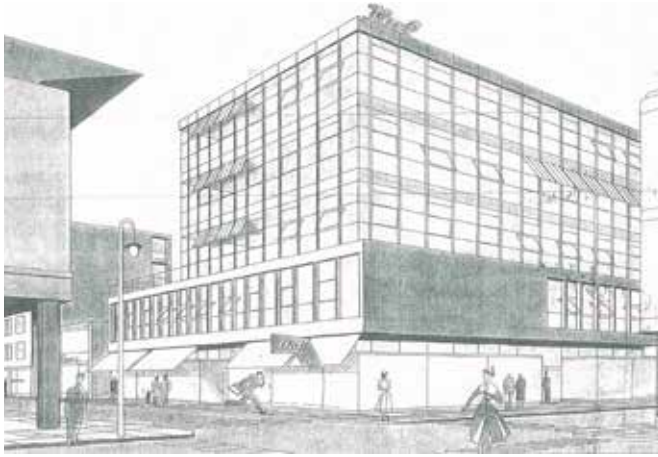

FIG. 5.16 Additional research in the archives produced this original perspective drawing featuring awnings to block out the sun. These were, however, never made / *Van den Broek & Bakema Architects – Het Nieuwe Instituut, Rotterdam*

The renovation project for the 1953 HUF Building in Rotterdam, designed by Van den Broek & Bakema, may serve as an example. Cleverly placed on top of a two-storey shoe store, three office floors feature a very elegant steel-and-glass curtain wall. Right from the start tenants applied all possible means to block out direct sunlight. Period photographs show how most of the windows were almost instantly covered by horizontal blinds, or even blacked out with tin foil or even wrapping paper, while ventilators were randomly integrated into the façade. Given the limited surface area of each floor and the fully glazed façades enclosing them, excessive overheating due to solar energy gain was indeed inevitable. We kept pondering how such competent and experienced architects could have made such an evident design error in the first place – until a second survey of the archives produced an original perspective drawing featuring external sunscreens. These were initially disregarded as a detail that might have been added just to dress up the image, but finding ourselves tangled up in the climate control problem we now read this drawing in another way.



FIG. 5.17 The HUF Building restored in 2009; the newly installed awnings allowed for the use of clear insulated glazing units instead of sun reflective glass panels / *Jannes Linders*

On-site inspection of the façade brought to light that the posts had indeed all been provided with holes and fixing points for the awnings. Although they were never installed, the sunscreens were apparently part of the original design.

Such an interpretation of the perspective drawing could hardly be expected from a researcher without any design experience himself. Integrating these findings into the (re-) design process, we decided to have similar awnings installed, only 56 years later. [FIG. 5.14, FIG. 5.15, FIG. 5.16, FIG. 5.17]

Designing from Heritage – Strategies for Conservation and Conversion

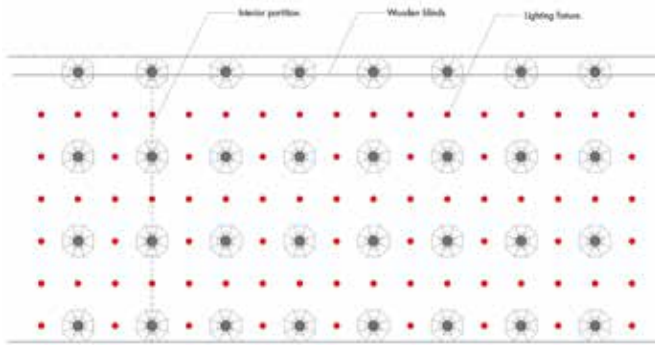

FIG. 5.18 Van Nelle Factory: scheme of the original distribution of service systems at the ceilings of the factory halls / *Claessens Erdmann Architects*

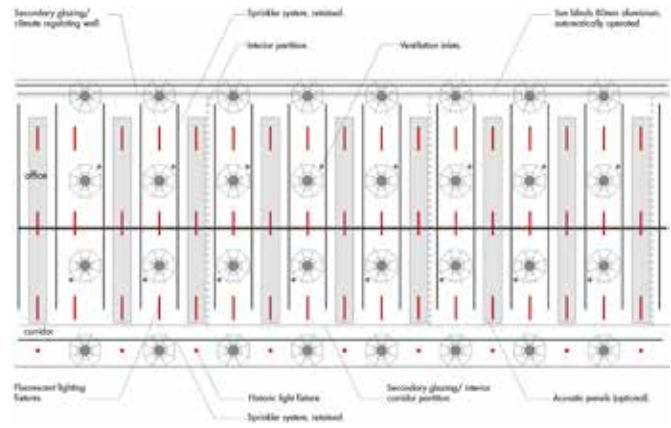

FIG. 5.19 Van Nelle Factory: scheme of the original distribution of the service systems in the ceilings of the factory halls / *Claessens Erdmann Architects*

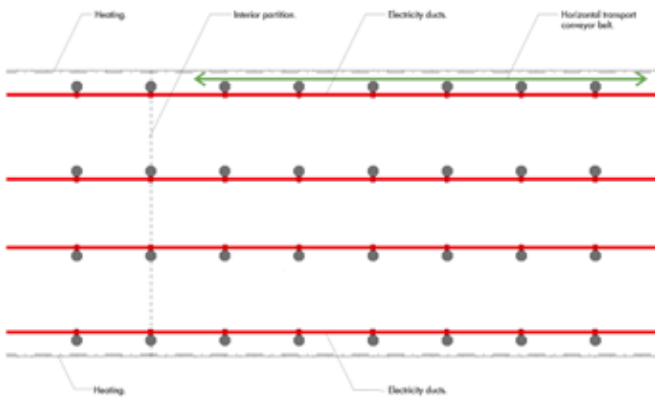

FIG. 5.20 Van Nelle Factory: scheme of the original distribution of service systems in the floor topping / *Claessens Erdmann Architects*

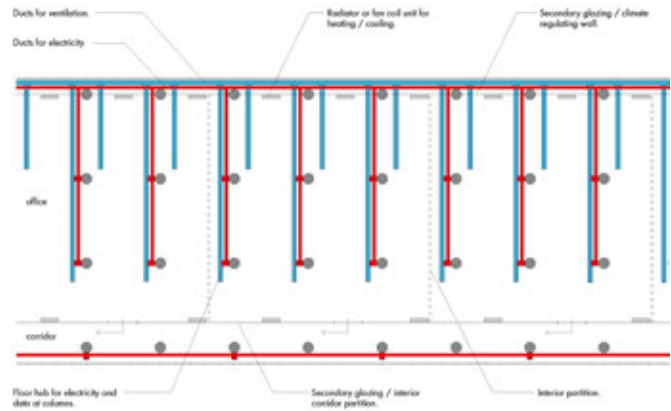

FIG. 5.21 Van Nelle Factory: distribution scheme of new service systems in the floor topping / *Claessens Erdmann Architects*

Another striking example of the advantage of a successful integration of research and design is the solution developed to insert up-to-date service systems in the transparent multi-storey daylight factory for the Van Nelle company.⁹²

We knew from previous historic building survey research that a 100 mm thick lightweight expanded concrete topping had been laid on the structural concrete floor slabs. On top of this, a coloured thin magnesite finish had been applied, chosen because this material was believed to be warm to the touch, which was supposed to contribute to the comfort of the workers on the factory floor.⁹³ On-site reinvestigations by our team of designer-researchers and building physics consultants discovered that the thick layer of lightweight concrete in fact accommodated original cable ducts. They allowed for existing production lines to be changed and new ones to be implemented.

We decided to reinterpret the original solution of the Van Nelle's architects, Brinkman & Van der Vlugt. Like them, we used the zone between the façade and the outermost row of columns for the main system trunk-runs from which we ran distribution branches for exhaust ducts, hot and cold water tubes, as well as power and data cabling through the thick floor topping. In the original layout, the service runs served lengthwise production lines. We however had to accommodate small business units perpendicular to the façades and we therefore rotated the systems grid by ninety degrees. In essence, the new installation followed the systems- and constructional logic of the original architectural concept.

[FIG. 5.18, FIG. 5.19, FIG. 5.20, FIG. 5.21]

In conclusion, a close interaction between research and design offers definite advantages that may benefit the quality of the project. Such benefits may result by assigning the preparatory research to the architects in charge of a reuse project as long as they are able to respect scientific standards and maintain objectivity.

⁹² The daylight factory is an early twentieth century architectural typology where the design is aimed at allowing daylight into the heart of the building, often employing shallow floor plates and multi-storey reinforced concrete frame with large glazed façades. See definitions in Banham 1986.

⁹³ This whole assumption is curious as each of the upper floors would be warmed by the heated air circulating in the halls below.

5.3 – Practice

While historic building surveys may provide a wealth of information, they can only ever lead to a best possible interpretation. There will always be gaps in the knowledge amassed and presented through such surveys. Dealing with these lacunae is the domain of the restoration architect. However it would be impossible for the architect to engage effectively in a design process aimed at balancing the functional and economic aims of a client with heritage values without preparatory research.

Apart from the typical problems related to the retention and proper repair of modern materials, such as exposed concrete and curtain-wall glazing, two major design challenges need to be tackled when dealing with the adaptive reuse of heritage buildings in an architecturally respectful manner: fitting a new functional program into the existing structure and creating an appropriate interior climate for the new use. Given the strong interrelation between the performance of the envelope and interior climate control, and the fragility of many of the light façade constructions of the modern era, the latter poses a particular challenge when Modern Movement buildings are concerned.

Function follows form

In contrast to the design of new structures, the redesign of existing ones requires a two-sided approach by the architect. The familiar rational method, which takes the program as a starting point (form follows function), primarily addresses the functional and commercial aims of the client and will therefore answer to the viability of the project as a whole. The reversed approach, taking the qualities of the building as point of departure (function follows form), is driven by cultural, historical and architectural values. These approaches are not successive separate tracks, but should be intertwined into an integrated, iterative process.



FIG. 5.22 An overview of the Technical School Patrimonium after restoration in 2013, showing the sectional doors of the former car mechanics workshop / Raoul Suermondt

When a new functional program needs to be accommodated into existing structures, we mostly revert to the original floor plans, even if the interior lay out has been changed over time. New programs for adaptive reuse are often found to fit in reasonably well. At Sanatorium ‘Zonnestraal’, the direct link between the heights of the spandrel in relation to the original use of each space provided guidance in identifying a suitable function for each room. Although only three original partition walls remained, we only adapted Duiker’s original floor plan when a new function could not be accommodated. For instance, the former dispensary was not reconstructed to allow for space for a new elevator lobby. A similar approach was followed at the directors’ offices at the Van Nelle Factory, where the interior plan was still largely intact and suitable for their continued use. But reconstructing the specific interior layouts of the generic spatial structure of the Van Nelle factory halls would have been rather meaningless and was therefore not undertaken.



FIG. 5.23 The former wood workshop in the Patrimonium School around 1956; the ventilation of the class rooms relied on operable windows / *Ad Windig – Maria Austria Instituut*



FIG. 5.24 A similar space in use today as a 'science lab' for physics teaching and research in 2016; the new ventilation supply ducts run along the ceilings / *Raoul Suermondt*

The Technical School Patrimonium in Amsterdam of 1956 is also characterized by a rather generic interior layout.⁹⁴ We here followed the same pragmatic approach as at Van Nelle though in this case with respect for the many original partitions that were still in place. Again, the more individual spaces in the building, such as the auditorium and the sports hall on the top floor, were put to similar uses for the new occupant, the Cygnus Gymnasium grammar school. Although this may seem an obvious strategy when replacing one school for another in the same building, these two educational institutes – the first technical and occupation directed, the second focussed on theory and academic traditions – largely differed in nature. Today, 'science labs' are accommodated in the same spaces that once served as wood and metal workshops.

The spaces originally accommodating a spacious forgery and workshops on the ground floor were respectively transformed into a new fitness studio and a canteen. The sectional doors of the original car mechanics workshop now serve the canteen's terrace. [FIG. 5.22, FIG. 5.23, FIG. 5.24]

⁹⁴ The First Technical School 'Patrimonium' in Amsterdam was designed by J.B. Ingwersen (1921–1996) of De Geus & Ingwersen Architects.

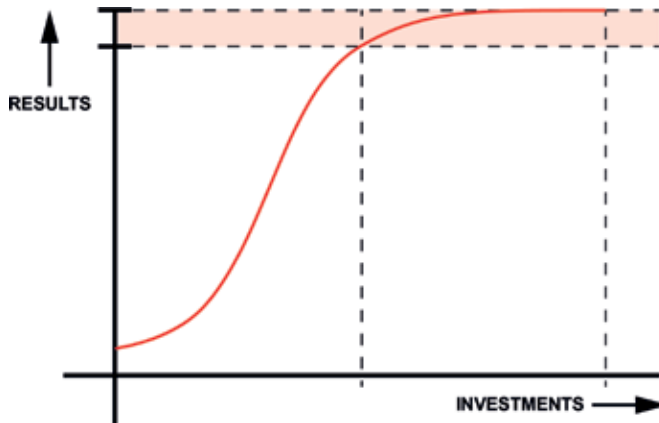

FIG. 5.25 The proportion between investments and the increase of performance when refurbishing a building is represented by an S-curve; complying in full with current standards while respecting heritage values may require disproportionate investments / Wessel de Jonge – TU Delft

Envelope and climate control

The above reasoning also applies to the level of materialization. Many modern buildings are characterized by Ludwig Mies van der Rohe's maxim that 'less is more', suggesting that the minimalisation of space, material and detail are a given. Tailoring a modern building to new requirements therefore hold major potential consequences for the building as a utilitarian object and as a cultural asset. However, one of the societal characteristics of our times is that performance demands regarding functionality, comfort and energy consumption are constantly being raised. Evermore material and building service systems are required to meet these requirements and often no space is available in existing structures for them. Incorporating new systems therefore calls for the utmost caution. One could question whether all buildings really have to meet all today's comfort requirements or whether these could slightly be relaxed and, in so doing, demand little or no modification of the original form. It may be added that, according to the S-curve, it is often possible to achieve major improvements, but that complying in full with current standards while honouring heritage values may require disproportionate investments. [FIG. 5.25]

Creating an interior climate that is appropriate for a building's new use is a key issue in adaptive reuse. This relies on the establishment of a proper balance between the performance of the building skin – mainly the façade– and the heating, ventilation and cooling (or air conditioning) systems. The latter are generally referred to as HVAC. To this end it is essential to call in the help of a building physics consultant at a very early stage. HVAC consultants tend to think only in terms of adding service systems. Building physics experts however are capable of assisting in redesigning a façade in such a way that a building skin is upgraded in terms of thermal insulation and ventilation in balance with the proportioned addition of systems, while integrating issues such as fire- and soundproofing. The more an upgraded skin of a building can contribute to its climate control, the less HVAC will be needed. This holds benefits for energy efficiency and sustainability and leads to a reduction of the number and scale of the interventions required in a building.

Façade upgrades

The first step to be taken when dealing with existing façades is to investigate the extent to which its thermal performance can be improved while retaining its historic architectural qualities. With adaptive reuse of modern buildings in mind, three principle strategies exist for the upgrading of their light façades: altering the existing façade itself, adding a secondary skin on the outside, or adding one on the inside.

Paradoxically, the decision to retain a façade and upgrade it usually implies that the existing (original) façade will have to be altered quite radically. The extant single glass panels of such façades are likely to be replaced by insulated glazing units, or IGUs. This may require the original window frames to be replaced as well. The rebates of slender steel-frame windows may be too shallow to accommodate standard IGUs and often the sash cannot carry their additional weight. Blind façade areas may have to be insulated and refinished either

from the outside or the inside, but this is likely to compromise the original finishings. However, this intervention may still be appropriate if the retention of original materials is deemed less important than conceptual and/or spatial qualities.

The strategy to upgrade the existing (original) façade is followed in most adaptive reuse projects. During the 'Zonnestraal' project, ample funding from the Cultural Heritage Agency of the Netherlands allowed us to develop prototypical solutions for the upgrading of such light façades and consequently to test them in practice. These glazing solutions, developed at high cost, were later successfully adopted in projects with more limited budgets, such as Duiker's Open Air School in Amsterdam (1930) and the Van den Broek & Bakema-designed HUF Building (1953). This latter project was commercial in nature and developing such innovative building parts anew was not possible due to financial and time restraints.

It is rarely feasible to fully comply with present standards of energy management and sustainability if the characteristics of a historic light façade have to be retained. Though in some cases feasible strategies can be found to significantly improve the façade's performance for the benefit of interior comfort and the environment.

Adding a secondary glazed skin inside the original façade of an existing building may be possible if there is enough space and if the existing (original) façade can continue to withstand climatic conditions. The second skin can be designed to comply with all required performance requirements. This way fewer alterations will need to be inflicted on the existing façade. The double-skin façade, also known as a 'climate wall' has become a well-appreciated and often-employed strategy in green building design. However, applying this solution to existing buildings means that the high level of maintenance required for the upkeep of the original façade remains.

The Van Nelle Factory has become well known as a prototype of this solution. Here, the disadvantage of losing valuable interior space was largely countered by smart interior planning. On the western side of the buildings, where solar heat gains are the highest, a secondary skin was positioned about one metre in from the existing façade. This is wide enough to allow for maintenance staff to enter the new in-between zone. The original pivot windows in the outer (original) façade have been automated and open to ventilate the cavity when temperatures rise too high. In winter the naturally heated air is directed into the workspaces. On the eastern side, the new secondary skin was inserted far enough from the existing façade to use the cavity created as the main circulation corridor – a space that was required by the programme in any case.

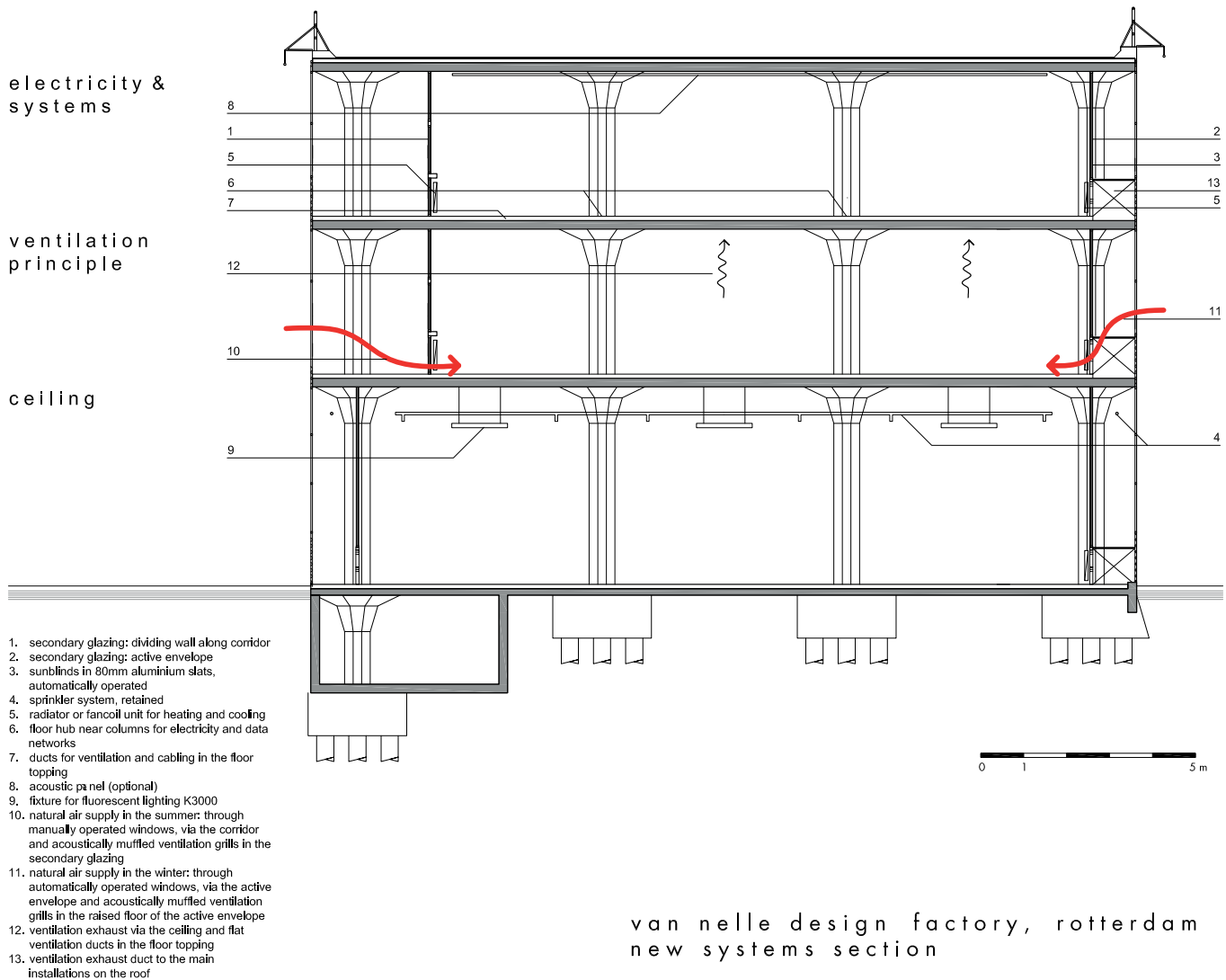

FIG. 5.26 Section of the Van Nelle Factory showing the new secondary skins in the façade and the new service systems for electricity, heating and cooling (top), ventilation (middle) and ceiling design (bottom) / Wessel de Jonge Architects



FIG. 5.27 A view inside the 'climate wall' at the western side, where solar heat gains are used during winter to pre-heat ventilation air before entering the workspaces / *Fas Keuzenkamp*



FIG. 5.28 A view inside the double-skin façade at the eastern side, where the cavity doubles as a corridor, required for proper circulation in any case / *Fas Keuzenkamp, Pijnacker*

Even if the double-skin solution in the former factory may never perform as well as in case of a new green building design, the building's energy performance has hugely improved and has received the highest rating for the sustainable redesign of heritage buildings.⁹⁵

[FIG. 5.26, FIG. 5.27, FIG. 5.28]

The last option, adding a secondary skin on the outside of a building, may provide a solution when the materialization of the existing (original) façade has great historical value but is exceptionally vulnerable to climate and thereof requires integrated protection. This is also a viable strategy when the outside appearance of the building is relatively insignificant in comparison to its interior. In most instances, this solution is chosen in order not to lose rentable floor space inside, as often is the case with internal secondary glazing. However, this strategy it is rarely seen as a viable solution for heritage preservation as it will completely alter the architectural appearance of a building.

95 Nusselder 2008. pp. 196-201.



FIG. 5.29 The Open Air School in Amsterdam (Jan Duiker 1930) shortly after completion, with its the huge vertical pivot windows and terraces located on the projecting corner / *Stadsarchief Amsterdam*



FIG. 5.30 Duiker understood that the only way to heat the (largely) open-air class rooms was to rely on radiation; he had heating pipes embedded in the reinforced concrete floors to make them act as radiation panels / *W. J. van Berselen, Stadsarchief Amsterdam*

HVAC systems

If upgrading the building skin is one side of the balance, the HVAC system is the other. In short, the best general strategy is to minimize the amount of HVAC equipment as far as possible. There are valid objections to the use of mechanical ventilation systems in terms of sustainability. They are also generally very large. HVAC systems not only require large plant rooms, which may be hard to accommodate inside a historic structure, but they also require bulky air ducts and vertical shafts to distribute the conditioned air through the building. These potentially have a major impact on interiors and, in case of transparent buildings, on exteriors as well.

As a basic point of departure, one should explore whether either the supply- or exhaust ducts can be avoided. Eliminating one or the other can reduce the total number of ducts by half. As already mentioned we were able to hide exhaust ducts in the thick floor topping at the Van Nelle Factory. These create an under-pressure in the workspaces located on the floor below, which causes fresh air to infiltrate in through the double façade construction. This is first heated or cooled by use of fan-coil units before reaching inhabited spaces. The design of this system meant that no supply ducts were required.



FIG. 5.31 Since classes are no longer taught outdoors, fresh air now is distributed through a small duct above the blackboard and then led through the overflow grate above the door to the staircase, which serves as a return duct / *Tom Elst*

Rather than locating ventilation grates in the historic façade of the factory, we had the air infiltration around the poorly locking windows measured. This showed that the amount of air infiltrating the façade naturally was sufficient to serve our purpose. This is a variation on the ‘function follows form’ theme: we made use of what is offered by the original building.

In the case of the Patrimonium School, it was not possible to draw air from outside because of the proximity of heavy traffic and the thereto-related pollution and noise. Here we developed a solution that brings fresh air into the classrooms through supply ducts, but uses the corridors and the staircase as the return shaft. This solution allowed for the original air overflows above the glazed partitions between classrooms and corridors to be reused. We developed shallow plywood boxes with linear slots on both sides and an acoustic lining to reduce cross noise to fit precisely between the top sill of these glazed portions and the ceiling. The same strategy was successfully repeated for Duiker’s Open Air School. Not only did we avoid exhaust ducts by making use of the staircase as a vertical stack, we even found that the supply ducts could be inserted into existing shafts. Very little of the HVAC system is to be seen, except for diffusers located above the blackboards. [FIG. 5.29, FIG. 5.30, FIG. 5.31]

Materialization

Conflicts may arise when it comes to the options available for new materials versus the original materials employed in a building. As we have seen, many architects of the Modern Movement preferred using industrially manufactured, mass produced and therefore cheap building components and products as a matter of principle. Many of those materials are no longer in production or available. This might be the case for instance with door handles, certain types of linoleum and other flooring materials, metal- and fibre panels, light fittings, switches, taps and other fittings and finishes. Alternatives have to be found and these can have an impact on the way the original is perceived.

Where possible, the difference between handmade and machine-made products and materials should remain visible. Because present-day mechanical production mostly delivers a much higher quality than historical processes did, some contemporary products – for instance glazed tiles – can look too perfect in a 1920s building. Other products, such as Celotex ceiling panels and many types of window hardware, may no longer be available at all. When the decision is made to have such industrial products replicated a paradox may emerge as replication often relies on costly handiwork or the expensive and time-consuming production of a small series on demand. This was the case for instance when two colours of jaspé linoleum had to be reproduced for use at 'Zonnestraal'.

Such conflicts also occur when considering replacing types of glass that are no longer readily available. It is common knowledge that many architects of the Modern Movement strove to achieve as immaterial an appearance as possible. To achieve this, they used plenty of glass, plain white walls, slender window- and doorframes, and so on. The drawn sheet glass that was widely in use for ordinary buildings at that time has a perceptible surface structure with widthwise deformities, or striations. Because of these striations the transparency and the reflective properties of drawn glass exhibit subtle

and characteristic distortions. The general use of drawn glass was superseded by float glass in the 1960s and there are few materials more immaterial in their manifestation than totally flat, uniform, float glass, which, as a result of its production process, has no texture whatsoever. Using float glass as glazing in Modern Movement buildings would perfectly satisfy the requirements with regard to conceptual authenticity: it has as immaterial an appearance as possible. However, selecting drawn glass would satisfy the requirements with regard to the original materialization. In contrast with float glass, drawn glass has a visible material appearance.

At 'Zonnestraal' we sought for a balance between 'substance' and 'idea'. This explains why, in line with the original specification for the buildings that lists 'window glass', we used drawn glass.

We chose to install single glazing in all spaces that do not require careful climate control, such as corridors and stairwells. The workrooms of the health care centre, however, could not be left single-glazed. A special solution, an 11mm insulating double glass unit, was designed to meet the criteria of both comfort and original appearance. Because single and double-glazing occasionally occur side by side, it was necessary to keep the difference in appearance between the two to a minimum. This required addressing the differences in distortions and reflections in the glass. As a first step, we chose to use colourless drawn glass for the outer pane of the double-glazing. To avoid any colour differences between double-glazed panels and adjacent single glazing, clear Starphire float glass – possibly even clearer than the colourless drawn glass – was imported from the USA for the inner pane of the double-glazing. By using neutral-coloured PVC spacers and special types of adhesives, it was possible to join the warped drawn glass outer pane with the flush inner float glass pane to form an insulating double-glazed unit. This bespoke system was even awarded a full manufacturer's guarantee. [FIG. 5.32, FIG. 5.33, FIG. 5.34]

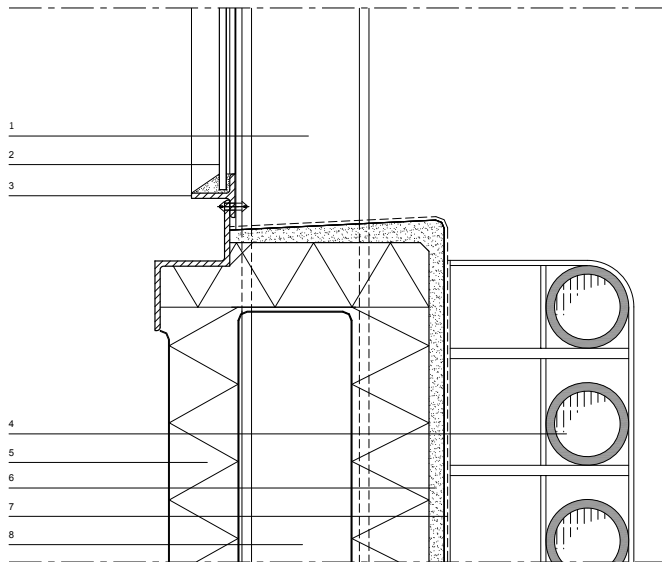

FIG. 5.32 Original vertical façade details of the 'Zonnestraal' Main Building of 1931, featuring single glazing / Wessel de Jonge Architects



FIG. 5.34 Detail of the drawn single glass at one of the corners of the Main Building after restoration in 2003 / Taco Hermans, Rijksdienst voor het Cultureel Erfgoed

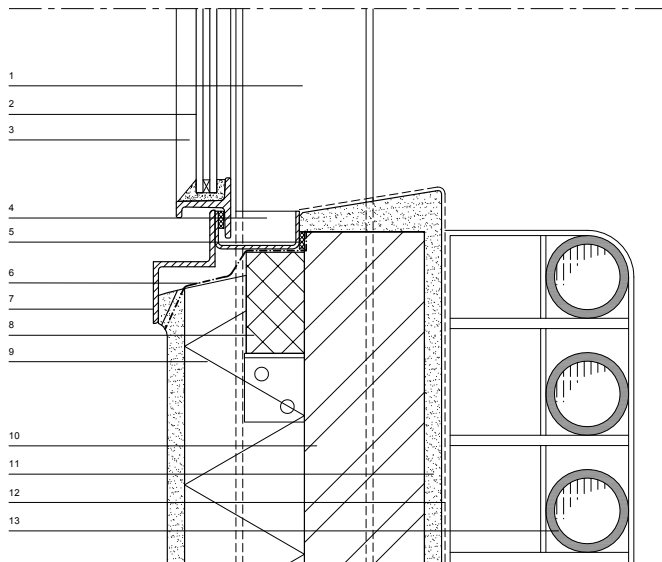

FIG. 5.33 Vertical façade details of the 'Zonnestraal' Main Building after the 2003 restoration, featuring bespoke insulating glazing units / Wessel de Jonge Architects



FIG. 5.35 Mock-up of various types of replacement glazing for the GAK Building; the original curtain wall in the background still features the original dark green double glazing / *Wessel de Jonge Architects*



FIG. 5.36 Close up of the redesigned new façade after replacement around 2015, featuring operable windows that project horizontally outward / *Luuk Kramer*

It has already been mentioned how this experimental restoration technology developed for 'Zonnestraal' has since been applied to projects with a more limited budget such as the HUF Building, albeit after minor modification.

Buildings of the post-World War II period are now starting to enter the realm of historic preservation. We therefore need to focus our attention on the multitude of glazing products, often to reflect direct sunlight by applying reflective coatings in order to reduce the level of solar heat gains, developed since the end of that war. Over time the glass industry has managed to make such coatings more and more unobtrusive, but buildings dating to the early post-war years often contain remarkable specimens of highly reflective blue-green, bronze or gold coloured glazing. These are often no longer commercially available and present a new challenge for the preservation world.

In this sense we were lucky when developing a proposal to accommodate small housing studios for young professionals in the former GAK Building in Amsterdam of 1959.⁹⁶ Characterised by an aluminium curtain wall with dark green heat-absorbing double-glazing the original design of the office block was modelled after the 1952 Lever House in New York that featured a similar glass façade.⁹⁷ However, the curtain wall of the GAK Building had reached the end of its technical lifespan. As the building was due to be listed as architectural heritage under municipal regulations, we were tasked with redesigning the façade to comply with current regulations while retaining the architectural character.

Fortunately the original type of green glass was still being produced. We used this to have insulating double-glazing assembled with exactly the same appearance as the original, but with an improved performance achieved by means of an additional low-energy coating on the inner glass pane. As the new programme included mainly housing, we redesigned the façade with operable windows. Thanks to their particular design, these are hardly visible when closed. [FIG. 5.35, FIG. 5.36]

Model-based design decisions

Our way of working relies on a model-based design process rather than developing single solutions for presentation to the client and heritage authorities. By analysing various solutions and identifying their pros and cons as objectively as possible, we try to present fundamental design choices. But, after the analysis stage has been concluded, we also feel obliged to be clear about our own preferences.

The issue of climate control at the HUF Building could be resolved through this model-based process. Reverting to the original transparency of the façades would have required the installation of extensive air conditioning systems. It would have been difficult to fit these into this minimalist and transparent structure and would also have contradicted our ambition to redevelop the building in a sustainable way. Two other options remained: installing new glazing with a very strong sun-reflective coating, or opting for exterior sunscreens that would allow for the use of neutral clear glass. The use of sun-reflective glazing was seen as being in conflict with the heritage values of the building, but the same could be said for the proposal to use awnings. Even though the use of awnings appeared to have been a part of the original design, none were ever installed, and they did not belong to the original state of the building. Yet, by comparing these options, a decision to install awnings was made. This option was seen by all parties as the best solution, both with regards to the heritage values and to the interests of the client.

⁹⁶ The Gemeentelijk Administratie Kantoor, or Municipal Administration Building, was designed by B. Merkelbach, P. Elling & A. Bodon and completed in 1959. More about this building in chapter 2.

⁹⁷ The headquarters of Unilever in New York were designed by Skidmore, Owings & Merrill in 1952.



FIG. 5.37 The Van Nelle Factory, documented for the UNESCO World Heritage nomination in 2013 / *Fas Keuzenkamp*

A similar strategy was followed to decide on the location of the ventilation ducts for the Van Nelle Factory. Because the mushroom-shaped heads of the columns were specifically designed to allow for flush ceilings and allow daylight deep into the factory, any addition of ventilation ducts – let alone installing false ceilings! – would have ruined the architectural concept. The alternative, incorporating the required ducts into the floor topping would require the demolition of the remaining original flooring. To be able to present both models objectively, we calculated the amount of original coloured magnesite flooring still extant. This was found to be less than 10%. The decision to sacrifice the remaining original flooring in order to maintain the original concept as a daylight factory was unanimous.

Process

Many traditional restorations are conducted in a context where socio-cultural parameters dictate decision-making and planning as long as budgetary constraints are respected. The sheer number of structures produced in the twentieth century means that also the number of buildings that are seen as culturally significant is rapidly increasing. As the Modern Movement produced ‘ordinary’ buildings rather than ‘icons’, as mentioned in chapter 2, we are confronted with the reality that much of what constitutes modern heritage, concerns buildings and ensembles that are, or should be, used on a daily basis and that represent economic value. If such a building is granted a new lease of life, its adaptive reuse must be sustainable and economically viable. This leads to planning, design and decision-making being increasingly driven by economic parameters, such as return on investment, marketing, running costs and efficiency in time planning.

Architects – who, at least in our part of the world, were used to conduct projects in conservation and restoration for public and non-commercial clients – now have to cooperate closely with project developers, investors and real estate professionals.

Therefore the architect needs to familiarize himself with the vocabulary of the real estate world in order to develop successful projects for these clients. A model-based design process is a good starting point as it allows for an objective consideration of all parameters. The more the architect is able to pair cultural with economic values, the more balanced a project may become. The Van Nelle Factory, for example, has a considerably lower vacancy rate than average office buildings of a comparable quality and new tenants are mostly found in a short time when vacancy occurs. One benefit of heritage may be that it is generally appreciated regardless of fashions and trends. In contrast to commercial objects that rely on the style of the day when it comes to the appeal of their image, heritage buildings in general do not require large investments for periodic ‘revamps’.

We believe that the quality of a design benefits from an integrated approach. This requires research-based expertise as well as experience and a great deal of professionalism from the architect to be able to make the right decisions. [FIG. 5.37] .



The inner structure of the lantern of the Centennial Hall at Wrocław, designed by Max Berg; partly inspired by the Roman Pantheon, the building is now a key reference work of modern engineering and architecture / *Marieke Kuipers*

References

- Aldbert, G. 2006. *Le Corbusier, Pierre Jeanneret - Doppelhaus in der Weißenhofsiedlung Stuttgart*. Baudenkmale Der Moderne. Stuttgart [u.a.]: Krämer.
- Adriaansz, E., Hamhuis, H. and Mason, P. 2001. *The Sonneveld House: An avant-garde home from 1933*. Rotterdam: NAI Publishers.
- Alexander, C. 1977. *The timeless way of building*. New York: Oxford University Press.
- Banham, R. 1960. *Theory and Design in the First Machine Age*. New York: Praeger.
- Banham, R. 1986. *Concrete Atlantis*. Cambridge MA: MIT Press.
- Barassi, S. 2007. 'The Modern Cult of Replicas: A Rieglian Analysis of Values in Replication'. *Tate Papers no.8*, Autumn 2007, <http://www.tate.org.uk/research/publications/tate-papers/08/the-modern-cult-of-replicas-a-rieglian-analysis-of-values-in-replication> [accessed 18 February 2017].
- Behne, A., Bletter, R. H., and Robinson, M. 1996 (1926). *The modern functional building*. Santa Monica: Getty Research Institute for the History of Art and the Humanities.
- Benjamin, W. and Underwood, J. A. 2008 (1936). *The Work of Art in the Age of Mechanical Reproduction*. London: Penguin Books.
- Bet, E. and Hinterthür, H. 2005. 'De kleur van naoorlogse wijken'. In: Hage, K. and Zweerink, K. (eds.). *Van Pendrecht tot Ommoord: geschiedenis en toekomst van de naoorlogse wijken in Rotterdam*. Bussum: Thoth. pp 50–55.
- Boito, C., Choay, F. and Mandosio, J. -M. 2000. *Conserver ou restaurer. Les dilemmes du patrimoine (1897)*, Besançon: Les Éditions de l'Imprimeur.
- Brand, S. 1994. *How Buildings Learn. What happens after they're built*. New York: Viking.
- Briolle C. and Repiquet, J. 2012. 'La rehabilitation de l'Aéroport d'Orly. Les espaces publics d'une aérogare historique à l'épreuve des usages'. In: Reichlin, B. and Grignolo, R. (eds.). *Lo spazio interno moderno come oggetto di salvaguardia/ Modern interior space as an object of preservation*. Mendrisio: Mendrisio Academy Press.
- Choay, F. 2001. *The Invention of the Historic Monument*. Cambridge: Cambridge University Press.
- Clarke, N. J. and Kuipers, M. C. 2017 (in press). 'Introducing the Heritage Value Matrix: Connecting Matter and Meaning in Built Heritage'. Paper for international conference *Intangibility Matters. International Conference on the values of tangible heritage*. Lisbon, LNEC.
- Cook I. and Richards C. 1993. 'Modern Movement documentation as a central resource for architectural education'. In: DOCOMMOMO (International Working-Party for Documentation and Conservation of Buildings, Sites and Neighbourhoods of the Modern Movement.) *Conference proceedings: second international conference, September 16th–19th, 1992*. Dessau: DOCOMMOMO Germany. pp. 68–72.
- Cramer, J. and Breitling, S. 2007. *Architecture in Existing Fabric. Planning. Design. Building*. Basel/Boston/Berlin: Birkhäuser.
- Cullen, G. 1961. *The Concise Townscape*. Van Nostrand Reinhold, New York.
- Cushman and Wakefield (formerly DTZ Zadelhoff). 2017. *Nederland Compleet. Factsheetskantoren- en bedrijfsruimtetmarkt 2017*. Cushman and Wakefield, Amsterdam.
- De Jonge, W. 2004. 'Zonnestraal': Restoration of a transitory architecture. Concept, planning and realisation in the context of its authenticity. In Wedebrunn, O. (eds.). *Technology of Sensations, The Alvar Aalto Vyborg Library', Proceedings of the 7th DOCOMMOMO International Technology Seminar, Vyborg, Russia (September 18–19, 2003)*, DOCOMMOMO preservation technology dossier 7, Copenhagen. pp. 12–33.
- De Jonge, W. 2005. 'Continuity and Change in the Architecture of Van Nelle / Continuïteit en verandering in de architectuur van Van Nelle. In: Molenaar, J. (ed.). *Van Nelle: Monument van de vooruitgang*. Rotterdam: De Hef. pp. 250–287.
- De Jonge, W. 2006. 'The Unbearable Lightness of Building. The "functionally differentiated outer wall" and the preservation of Modern Movement buildings.' In: Tomlow, J. (ed.) *Climate and building physics in the modern movement: [proceedings of the 9th International DOCOMMOMO Technology Seminar, June 24/25 2005, House Schminke, Löbau, Germany]*. pp. 27–45.
- De Jonge, W. 2010a. 'Load-bearing construction.' In: Meurs, P and Van Thoor, M. -T. (eds.) *Sanatorium Zonnestraal. History and restoration of a modern monument*. Rotterdam: NAI. pp. 24–49.
- De Jonge, W. 2010b. 'Infills and finishes.' In: Meurs, P and Van Thoor, M. -T. (eds.) *Sanatorium Zonnestraal. History and restoration of a modern monument*. Rotterdam: NAI. pp. 88–97.
- De Jonge, W. 2010c. 'Nieuwe Bouwen in practice / Het Nieuwe Bouwen in de praktijk.' In: Meurs, P and Van Thoor, M. -T. (eds.) *Sanatorium Zonnestraal. History and restoration of a modern monument*. Rotterdam: NAI. pp. 110–119.

Designing from Heritage – Strategies for Conservation and Conversion

- De Jonge, W. 2010d. 'History of use.' In: Meurs, P and Van Thoor, M. -T. (eds.) *Sanatorium Zonnestraal. History and restoration of a modern monument*. Rotterdam: NAI. pp. 120–129.
- De Jonge, W. 2010e. 'Research and plan of restoration / Onderzoek en restauratieplan.' In: Meurs, P and Van Thoor, M. -T. (eds.) *Sanatorium Zonnestraal. History and restoration of a modern monument*. Rotterdam: NAI. pp. 160–169.
- De Jonge, W. 2010f. 'Implementation / Uitvoering' In: Meurs, P and Van Thoor, M. -T. (eds.) *Sanatorium Zonnestraal. History and restoration of a modern monument*. Rotterdam: NAI. pp. 216–233.
- De Jonge, W. and Henket H. A. J. 2010a. 'Historic building survey on Modern Movement buildings, Zonnestraal as a touchstone / Bouwhistorisch onderzoek naar de gebouwen van de Moderne Beweging. Zonnestraal als toetssteen.' In: Meurs, P and Van Thoor, M. -T. (eds.) *Sanatorium Zonnestraal. History and restoration of a modern monument*. Rotterdam: NAI. pp. 101–109.
- De Jonge, W. and Henket, H.A.J. 2010b. 'The Restoration Concept / Restauratieconcept.' In: Meurs, P and Van Thoor, M. -T. (eds.) *Sanatorium Zonnestraal. History and restoration of a modern monument*. Rotterdam: NAI., pp. 179–184.
- De Jonge, W. and Henket, H. A. J. 2010c. 'The Restoration.' In: Meurs, P and Van Thoor, M. -T. (eds.) *Sanatorium Zonnestraal. History and restoration of a modern monument*. Rotterdam: NAI. pp. 185–200.
- De Jonge, W. and Fischer, S. 1999–2002. *Van Nelfabrieksgebouwen, Bouwhistorisch onderzoek; Centrale Expeditie, Rapport en Fotodocumentatie; Ketelhuis; Pakhuizen; Bedrijven; Kantoor*. (unpublished reports available in Library Cultural Heritage Agency of the Netherlands).
- De Jonge, W. and Meurs, P. 2010. 'The Zonnestraal Aftercare Colony. Design and Buildings / Nazorgkolonie Zonnestraal. Ontwerp en gebouwen ' In: Meurs, P and Van Thoor, M. -T. (eds.) *Sanatorium Zonnestraal. History and restoration of a modern monument*. Rotterdam: NAI. pp. 77–87.
- Denslagen, W. F. 1994. *Architectural Restoration in Western Europe: Controversy and Continuity*. Amsterdam: Architectura & Natura Press.
- Douet, James. 2013. *Industrial Heritage Re-tooled: The TICCIH Guide to Industrial Heritage Conservation*. Left Coast Press, Inc.
- DTZ Zadelhoff. 2015. *Nederland Compleet. Factsheetkantoren- en bedrijfsruimetmarkt 2015*. DTZ Zadelhoff, Amsterdam.
- Duiker, J. 1932. 'Dr Berlage en de Nieuwe Zakelijkheid' In: *De 8 en Opbouw*. 1932, pp. 43–51.
- Dushkina, N. 2010. 'The "challenge of change" and the 20th century heritage.' In: Falser, M. S., Lipp, W., and Tomaszewski, A. (eds.). *Conservation and preservation: interactions between theory and practice : proceedings of the international conference of the ICOMOS International Scientific Committee for the Theory and the Philosophy of Conservation and Restoration, 23–27 April 2008 (Vienna, Austria)*. Firenze, Polistampa. pp. 187–199.
- Gebessler, A. 2003. *Gropius, Meisterhaus Mueche/schlemmer: Die Geschichte Einer Instandsetzung*. Stuttgart: Karl Krämer.
- Gelinck, S. & Strolenberg, F. 2014. *Rekenen op herbestemming: idee, aanpak en cijfers van 25 + 1 gerealiseerde projecten*. Rotterdam: NAI010.
- Glendinning, M. 2013. *The conservation movement: a history of architectural preservation : antiquity to modernity*. London: Routledge.
- Guigon, E., Van der Werf, H., Aubry, M., and Braat, J. R. 2006. *L'Aubette ou la couleur dans l'architecture. Une oeuvre de Hans Arp, Sophie Taeuber-Arp, Theo van Doesburg. Strasbourg: Association Theo van Doesburg/Musées de Strasbourg*. [Also available in Dutch].
- Halbertsma, M. E. and Kuipers, M. C. 2014. *Het erfgoeduniversum: een inleiding in de theorie en praktijk van cultureel erfgoed*. Bussum: Uitgeverij Coutinho.
- Harrison, R. 2010. *Understanding the politics of heritage*. Manchester: Manchester University Press in association with the Open University.
- Hendriks, L., and Van der Hoeve, J. 2009. *Guidelines for Building Archeological Research*. Den Haag: Rijksdienst voor het Cultureel Erfgoed.
- Henket, H. A. J. and De Jonge, W. 1990. *Het Nieuwe Bouwen en Restaureren. Het bepalen van de Gevolgen van Restauratiemogelijkheden*, 1990, Rijksdienst voor de Monumentenzorg/Staatsuitgeverij, Zeist/Den Haag pp. 96–100. [English summary].
- Henket, H.A.J. and De Jonge, W. 2010a, 'A restoration concept for Modern Movement architecture / Een restauratieconcept voor architectuur van de moderne beweging'. In: Meurs, P and Van Thoor, M. -T. (eds.) *Sanatorium Zonnestraal. History and restoration of a modern monument*. Rotterdam: NAI. pp. 98-100.
- Henket, H.A.J., and De Jonge, W. 2010b. 'Structure plan for the Zonnestraal Health Care Estate / Zonnestraal, landgoed voor zorg en gezondheid. Het Structuurplan'. In: Meurs, P and Van Thoor, M. -T. (eds.) *Sanatorium Zonnestraal. History and restoration of a modern monument*. Rotterdam: NAI. pp. 170-173.
- Heynen, H. 2014. *'Dát is architectuur': Sleutelteksten uit de twintigste eeuw*. Rotterdam: NAI010.
- Howard, P. 2003. *Heritage: Management, interpretation, identity*. London: Continuum.
- Huse, N. 2006. *Denkmalpflege: deutsche Texte aus drei Jahrhunderten*. München: Beck.
- ICOMOS (International Council on Monuments and Sites). 1964. *The Venice Charter*. Paris: ICOMOS.
- ICOMOS (International Council on Monuments and Sites). 1993. *Guidelines on Education and Training in the Conservation of Monuments, Ensembles and Sites*. Paris: ICOMOS.

- ICOMOS (International Council on Monuments and Sites). 2014. *The Florence Declaration on Heritage and Landscape as Human Values*. Paris: ICOMOS.
- Kalf, J. and Nederlandse Oudheidkundige Bond (NOB). 1917. *Grondbeginselen en voorschriften voor het behoud: De herstelling en de uitbreiding van oude bouwwerken*. Leiden: G.F. Théonville
- Kuipers, M. C. 1998a. 'The Long Path to Preservation in The Netherlands.' *Transactions of the Ancient Monuments Society*. Vol. 42, pp. 13–34.
- Kuipers, M. C. 1998b 'Recording the Recent Heritage in the Netherlands.' In: Cunningham, A. (ed.), *Modern Movement Heritage. A Challenge to Manage*. London/New York: E&FN Spon. pp. 66–73.
- Kuipers, M. C. 2005a. 'The Paradox of the Modernist Monument.' In: Backer, A. M., Camp, D. L. and Dicke, M. (eds.). *Van Nelle, Monument in Progress*. Rotterdam: De Hef. pp. 218–225.
- Kuipers, M. C. 2005b. 'Fairy Tales and Fair Practice, Considering Conservation, Image and Use.' In: Andrieux, J.-Y. and Chevallier, F. (eds.). *La réception de l'architecture du Mouvement moderne : Image, usage, héritage/The Reception of Architecture of the Modern Movement: Image, Usage, Heritage. proceedings of the Seventh International Docomomo Conference. Saint-Étienne: Publications de l'Université de Saint-Étienne*. pp. 206-213.
- Kuipers, M. C. 2010. 'The aftercare of Zonnestraal. Heritage preservation and the future.' In: Meurs, P and Van Thoor, M. -T. (eds.) *'Sanatorium Zonnestraal. History and restoration of a modern monument*. Rotterdam: NAI. pp. 254–261.
- Kuipers, M. C. 2011. 'Authenticiteit versus attrappenkult?' In: Stroux, S., Quist, W., Foole, F., and Eikhoudt. *Reco.mo.mo: hoe echt is namaak, hoe dierbaar het origineel?* Delft: Publikatieburo Bouwkunde. pp. 8–11.
- Kuipers, M. C. and Quist, W. J. (eds.). 2013. *Culturele draagkracht. Op zoek naar de tolerantie voor verandering bij gebouwd erfgoed*. Delft: Delftdigitalpress.
- Lowenthal, D. 2015. *The Heritage Crusade and the Spoils of History*. Cambridge: Cambridge University Press.
- Lynch, K. 1960. *The Image of the City*. MIT Press.
- Markgraf, M. 2006. *Archäologie der Moderne: Sanierung Bauhaus Dessau/ Archaeology of Modernism*. Berlin: Jovis Verlag.
- Meurs, P. 2016. *Heritage-based design*. Delft: TU Delft - Heritage & Architecture.
- Murtagh, W. J. 2006. *Keeping Time. The History and Theory of Preservation in America*. Hoboken: Wiley & Sons.
- Myers, D., Smith S. N. and Ostergren, G. (eds.) 2016. *Consensus Building, Negotiation, and Conflict Resolution for Heritage Place Management: Proceedings of a Workshop Organized by the Getty Conservation Institute, Los Angeles, California, 1-3 December 2009*. Los Angeles: Getty Conservation Institute.
- Nusselder, E. (ed.). 2008. *Handboek duurzame monumentenzorg: theorie en praktijk van duurzaam monumentenbeheer*. Rotterdam: SBR.
- Orbasli, A. 2008. *Architectural Conservation: Principles and Practice*. Oxford: Blackwell Science.
- Price, N. S., Kirby Talley, M., and Melucco Vaccaro, A. 1996. *Historical and philosophical issues in the conservation of cultural heritage (Readings in conservation, 1996: 1)*. Los Angeles: Getty Conservation Institute.
- Prudon, T. H. M. 2008. *Preservation of modern architecture*. Hoboken, N.J.: Wiley.
- RCE (Rijksdienst voor het Cultureel Erfgoed.) 2012. *Een toekomst voor kerken handreiking voor het aanpassen van kerkgebouwen in religieus gebruik*. Amersfoort: Rijksdienst voor het Cultureel Erfgoed.
- RDMZ and Kuipers, M. C. 1998. *Cultuurhistorische Verkenning Van Nelle-complexe Rotterdam* (with L. Prins, R.J. Wielinga and Tj. Visser), Zeist: Netherlands Department for Conservation, February 1998 (unpublished reports available in Library Cultural Heritage Agency of the Netherlands).
- Remøy, H.T. and Van der Voordt, T. J. M. 2007. 'A new life: conversion of vacant office buildings into housing.' *Facilities* Vol. 25 (3/4), pp. 88–103.
- Rodopoulou, T.C. 2016. 'Heritage-led Regeneration in the UK – Preserving Historic Values or masking Commodification? A Reflection of the Case of King's Cross, London' In: Hein, C. (ed.). *17th IPHS Conference, Delft 2016 | HISTORY - RESILIENCE | URBANISM | VOLUME 04. Planning and Heritage*. pp. 75-88.
- Roos, J. 2007. *De ontdekking van de opgave: herontwikkeling in de praktijk = Discovering the assignment = redevelopment in practice*. Delft: VSSD.
- Rossi, A. 1981. *The Architecture of the City*, Cambridge MA: MIT Press.
- Rothuizen, J. 2014. *The Soft Atlas of Amsterdam*. Amsterdam: Nieuw Amsterdam Uitgevers.
- Rutgers, B., Doornenbal, K. and Tonkens, S. 2003. *Theater Tuschinski : Restauratie van een droom = restoration of a dream*. Warnsveld: Terra.
- Salastie, R. (ed.). 2010. *Integrity and authenticity in modern movement architecture - case Paimio Hospital: international expert seminar 1-2 October in 2009 in the Paimio Hospital*. Helsinki: Yliopistopaino.
- Sanders, L. A. 1907. *Het cement-ijzer in theorie en praktijk*. Amsterdam: W.J. Ahrend.
- Schmidt, R. III and Austin, S. 2016. *Adaptable Architecture: Theory and practice*. New York: Taylor & Francis.
- SHBO. 1987. *Richtlijnen voor de opmeting en vragenlijst voor de beschrijving van oude boerderijen*. Arnhem: SHBO (unpublished report available in library of the Cultural Heritage Agency of the Netherlands).
- Sire, M.-A. 2005. *La France du patrimoine: les choix de la mémoire*. Paris: Gallimard / Monum, Ed. du Patrimoine.
- Stenvert, R. and Van den Tussenbroek, G. 2015. *Inleiding in de bouwhistorie: Opmeten en onderzoeken van oude gebouwen*. Utrecht: Uitgeverij Matrijis.

Designing from Heritage – Strategies for Conservation and Conversion

Tomlow, J. 2006. *Climate and building physics in the modern movement: [proceedings of the 9th International DOCOMOMO Technology Seminar, June 24/25 2005, House Schminke, Löbau, Germany]*.

Van Balen, K. 2008. 'The Nara grid: An Evaluation Scheme Based on the Nara Document on Authenticity'. *APT Bulletin: Journal of Preservation Technology*, Vol. 29, nr. 2–3, pp. 39–45. <http://www.jstor.org/stable/25433951?origin=JSTOR-pdf> [accessed 18 February 2017].

Van den Heuvel, D., Mesman, M., Quist, W., and Lemmens, B. 2008. *The challenge of change dealing with the legacy of the Modern Movement : Proceedings of the 10th International Docomomo Conference*. Amsterdam: IOS Press.

Van Eldik 1987. 'Gewapend beton: het bouw materiaal van de twintigste eeuw. Een historische verkenning van de vroegere betonbouw'. In: Bak, P., Molema, J., and Stichting Analyse van Gebouwen (Delft). *Jan Gerko Wiebenga: Apostel van het Nieuwe Bouwen*. Rotterdam: O10. pp. 18–25.

Van Immerseel, R. & Hendriks, L. 2010. *Richtlijnen voor Tuinhistorisch Onderzoek voor Waardstelling van Groen Erfgoed*. Amersfoort: RCE (available as pdf).

Van Loghem, J. B. 1932. *Bouwen: nieuwe zakelijkheid : neues Bauen : vers une architecture réelle : built to live in : Hollan = Bâtir = Building*. Amsterdam: Kosmos.

Venturi, R., Scott Brown, D. and Izenour, S. 1972. *Learning from Las Vegas*. Cambridge MA: MIT Press.

Viollet-le-Duc, E.-E. and Huss, G. M. 1895. *Rational building, being a translation of the article "Construction" in the Dictionnaire raisonné de l'architecture française of M. Eugène-Emmanuel Viollet-le-Duc*. New York: MacMillan & Co.

Watt, D. 1996/2015. *Surveying Historic Buildings*. London: Routledge.

Wohlleben, M. 1989. *Konservieren oder restaurieren?: zur Diskussion über Aufgaben, Ziele und Probleme der Denkmalpflege um die Jahrhundertwende*. Zürich: Verl. d. Fachvereine.

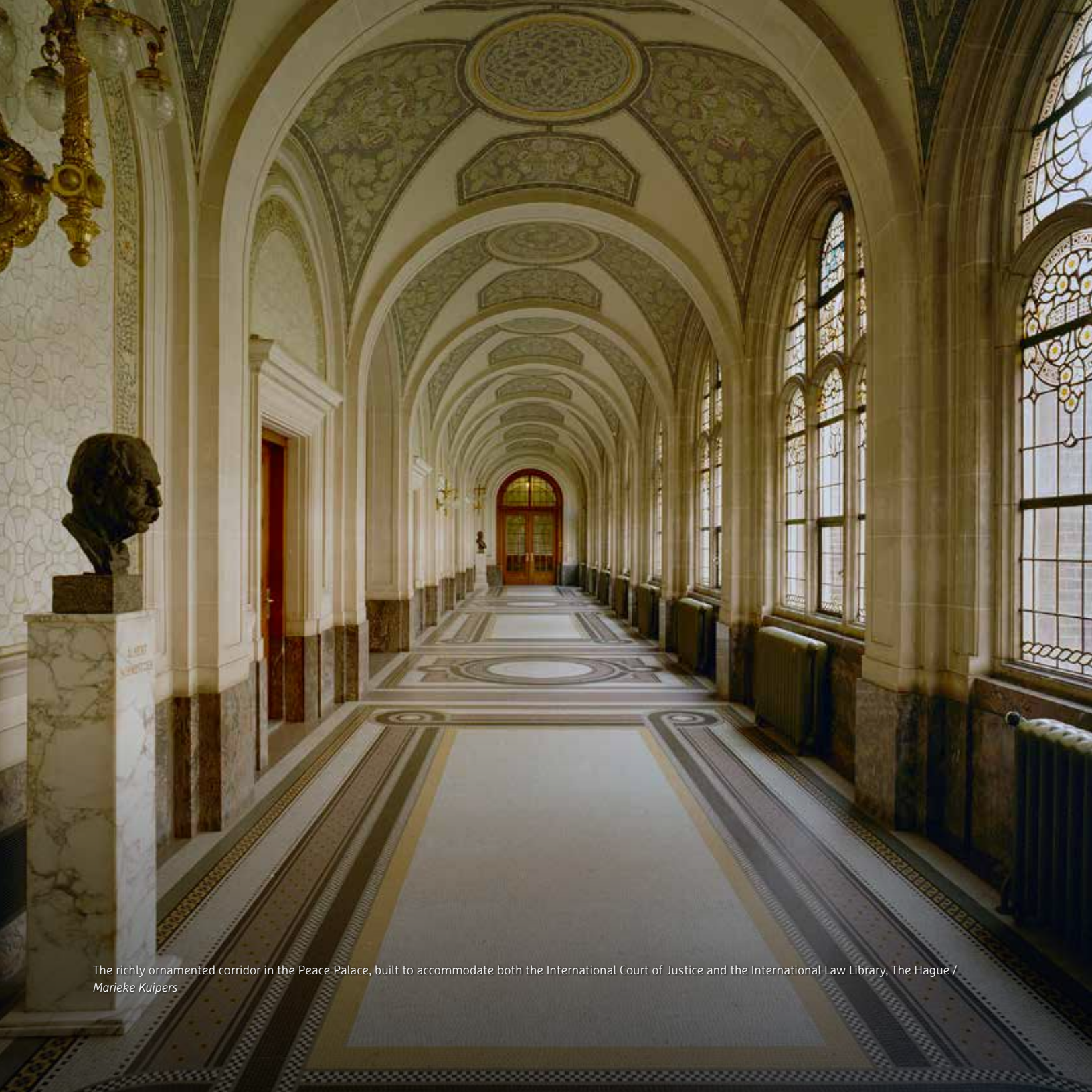

The richly ornamented corridor in the Peace Palace, built to accommodate both the International Court of Justice and the International Law Library, The Hague /
Marieke Kuipers

Colophon

Published by

TU Delft - Heritage & Architecture (Fac. Architecture) on behalf of the Rondeltappe Bernoster Kemmers Foundation

The Rondeltappe Bernoster Kemmers Foundation was established in 1995 by architect Leendert Rondeltap from The Hague with the aim of purchase and conservation of Dutch Heritage Monuments.

Rondeltap was the architect of the Europa Hotel in The Hague, among other buildings, and was also professor Architectural Drawing at the Royal Academy of Visual Arts.

The Foundation can assign awards to private persons or institutions. In this framework, the Foundation has made a cooperation agreement with the Faculty of Architecture of TU Delft: during five years, starting in 2014, annual publications will be issued in the Rondeltappe book series. The publications will be used for the MSc education of the section Heritage & Architecture of the Faculty of Architecture at Delft University.

To learn more about the objects belonging to the Foundation please refer to the website: www.stichtingrbk.nl.

Thanks to

Foundation Rondeltappe-Bernoster-Kemmers (RBK, The Hague), Prof. Miles Glendinning (Architectural Conservation University of Edinburgh, Director Scottish Centre for Conservation Studies) and Adj. Prof. Andrea Canziani (Politecnico di Milano) for reviewing this book and Pr. Arch Nicholas Clarke, PhD Candidate TU Delft, for his co-operation.

Series editor in chief

Dott. Silvia Naldini

English copy editor

Nicholas Clarke, Pr. Arch.

Design

Sirene Ontwerpers, Rotterdam



12 ---

7 ---

5 ---

14 13 | 12 | 11 | 10 | 9 | 7 | 6 |

8